



# BE-D SERIES

DC CHARGING STATIONS





## BE-D Series

BE-D is a range of wall mounting charging stations for charging in direct current DC with a rated power of 25kW and equipped with a cable with a CCS2 or CHAdeMO connector or with two cables with a CCS2 and CHAdeMO connector respectively, to be positioned on specific holders when not in use. The user interface is guaranteed by a touch screen display. BE-D charging stations, equipped with Ethernet-WiFi-2/3/4G connectivity, can be managed through Scame proprietary Management System or can be connected to an external E-Mobility Service Provider via standard OCPP communication protocol. Made of halogen-free thermoplastic materials and embellished with a powder-coated aluminium frame, they are characterized by clean and essential lines, signed by Trussardi+Belloni Design, which make them the ideal choice in any context. A specific pedestal in powder-coated steel allows BE-D charging stations floor mounting.

technical sheet p. 6

## Technical information

### Main characteristics



- 01** Rear metal bracket to facilitate wall fixing during installation procedure
- 02** TFT touch screen display activated by a presence sensor to optimize energy consumption in stand-by
- 03** Connector holders with powder-coated aluminium frame
- 04** Powder-coated aluminium frame
- 05** RFID reader for user authentication
- 06** Connectivity via Ethernet-WiFi-2/3/4G
- 07** Removable power modules to facilitate the installation procedure
- 08** Possibility of graphic customization of the front panel with client's logo by printing (on demand)

## BE logo

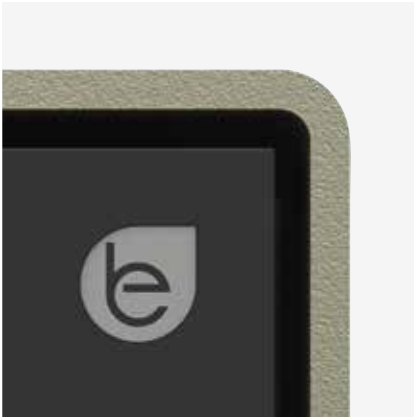

Within the vast offer of Scame Parre, the BE logo, alongside the institutional one, identifies and characterizes the line of products intended for electric vehicles recharging.

By exhibiting it, the stations, the charging cables and the related components are the bearers of over twenty years of company experience in the e-mobility sector, going back to 1999 the presentation by Scame Parre of the first connector specifically designed for this application.

Above all, however, they convey the message behind the logo itself: "Be Eco".

An invitation to embrace a concept of sustainable mobility as an integrated part of a lifestyle that respects man and the environment, rather than a recognition for those who have already done so by choosing one of our products.

A logo in the form of a stylized leaf that, almost resting on the product, leaves an indelible mark on it, adding another chapter to the story of passion, sustainability and innovation from that of Scame.

## Graphic customization



Wanting to add an identity trait, the BE-D charging stations can be graphically customized by printing your company logo on a portion of the front panel.

Graphic customization must be requested by specifying the code **209.CU01-D** when ordering and by sending your logo exclusively in vector format.

Strongly convinced that design is a fundamental component of the brand and the product, Scame Parre reserves the right not to accept graphic proposals that are incompatible with the image of the brand and its stations.

## Application examples



## Management system

Scame charging stations can be monitored and managed remotely either via Scame Local Management System or they can be connected to an external OCPP Central Station.

### SCAME LOCAL MANAGEMENT SYSTEM

Scame BE-D charging stations can be monitored and managed remotely via Scame proprietary Management System.

The proprietary software is embedded in all BE-D charging stations, is licence free and manages the specific unit.

Scame Management System must be configured in a local area network and does not require any additional software installation as access to the Management System is performed with credentials via LAN IP address.

Scame Management System provides full control over and allows a comprehensive set of actions and information on the system such as charging point status, live charging session data, management of authorized users list, data consumption monitoring, search/filter/download all transactions, Start/Stop/Resume transactions, update firmware and much more.

### OCPP EXTERNAL MANAGEMENT SYSTEM

Scame charging stations can be connected to an external E-Mobility Service Provider (EMSP) via OCPP 1.6 JSON standard communication protocol. In this case the stations will be managed by the external EMSP and may allow further services such as billing operations and station booking. Connecting the stations to an external Management System may require you to sign a contract with the EMSP and yearly subscription fees may apply.

Scame guarantees the compatibility between it's charging stations and external E-Mobility Service Providers that have undergone an OCPP 1.6 JSON compatibility test.

The list of approved EMSP is available upon request: contact your Scame representative for more information.

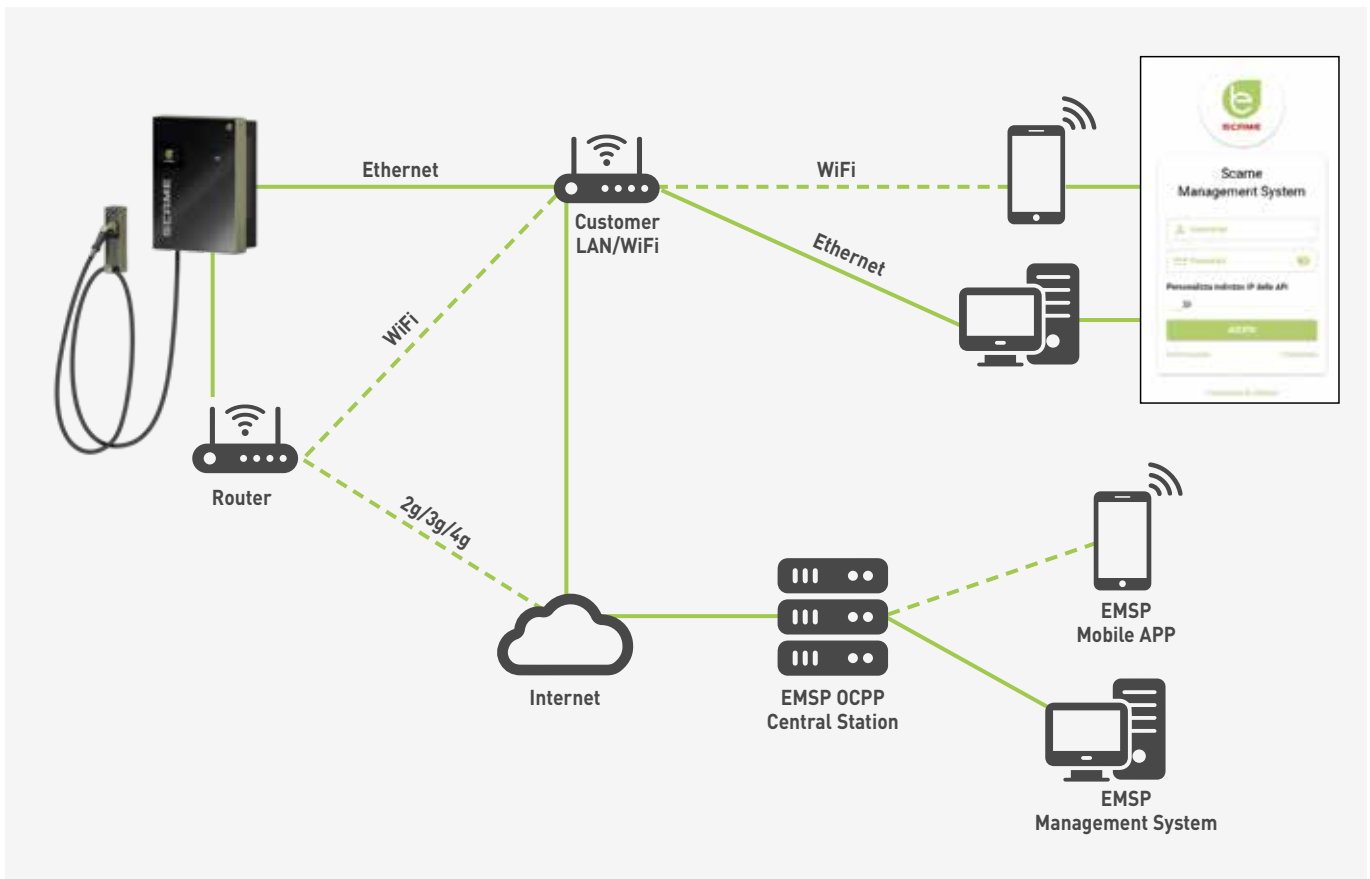

## BE-D SERIES



Rated power	Connectors	Features	Code
25kW	 CCS2	 CHAdeMO	
	1		MANAGEMENT SYSTEM 206.D91-E10
		1	MANAGEMENT SYSTEM 206.D91-E11
	1	1	MANAGEMENT SYSTEM 206.D91-E12

User access mode to stations: free without authentication, with local authentication via user card RIFD or with remote authentication via OCPP Central Station

**CABLE LENGTH:**  
4,5m

## ACCESSORIES



Description	Code
PEDESTAL DIRECT FIXING	208.AP60
PEDESTAL BRACKETS FIXING	208.AP61

## SERVICES

Description	Code
FRONT PANEL GRAPHIC CUSTOMIZATION	209.CU01-D
COMMISSIONING (COMPULSORY)	209.ST02

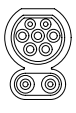

CCS2  
standard



CHAdeMO  
standard

# BE-D SERIES

## DC CHARGING STATIONS



## VERSIONS

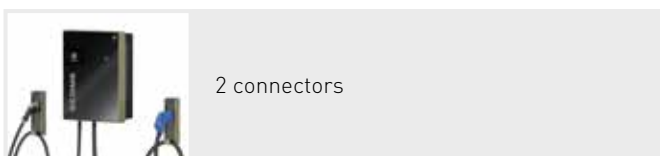
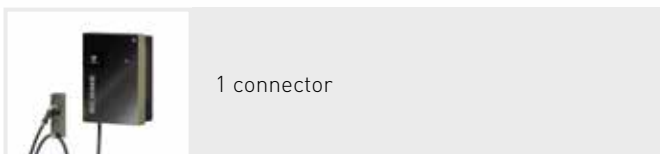

## USER INTERFACE AND SYSTEM CONTROL

HMI:	7" TFT touch screen display with adjustable backlight motion and ambient light sensors
Connectivity:	GSM 3G/4G modem Ethernet port 1 x LAN 10/100Mbps WiFi IEEE 802.11b/g/n, Access Point (AP), Station (STA)
User authentication:	Free RFID ISO1443A MiFare Classic, MiFare Plus, MiFare DESFire
Communication protocol:	OCPP 1.6 JSON

## REFERENCE STANDARDS

IEC/EN 61851-1

IEC/EN 61439-7

## TECHNICAL CHARACTERISTICS

AC input power connection:	3P+N+PE
Supply voltage:	400Vac +/- 10%
AC power supply:	Nominal 27kW 40A - Peak 27kW 40A
Frequency:	50/60Hz
Efficiency:	94% at rated power
Power meter:	Class B MID (Energy meter 3P+N 63A Modbus MID)
Output power:	Peak 25kW - Continuous 25kW
Output voltage:	CCS2 150Vdc - 1000Vdc Chademo 150Vdc - 500Vdc
Output current:	Max 60Adc
Number of DC outputs:	Max 2 connectors
Standards of DC connectors:	CCS2, CHAdeMO
Number of AC outputs:	N/A
Standards of AC connectors:	N/A
Cable length:	4,5m
Number of simultaneous charging sessions:	DC single charging
Protection degree:	IP54
Impact resistance rating (according to IEC 62262):	IK10
Cooling system:	Forced air
Operating ambient temperature:	-30°C +45°C (from 45°C with derating)
Storage temperature:	-30°C +60°C
Operating altitude:	2500m max
Humidity:	5% ÷ 95% non condensating
Acoustic noise:	<55 dB in all directions
Material:	Thermoplastic (Halogen Free) Powder-coated aluminium
Weight:	Approximately 70kg excluding the cables
Mounting:	Surface mounting
Pedestal:	Optional
Emergency pushbutton:	Yes

Code 206.D91-E10  
 206.D91-E11  
 206.D91-E12

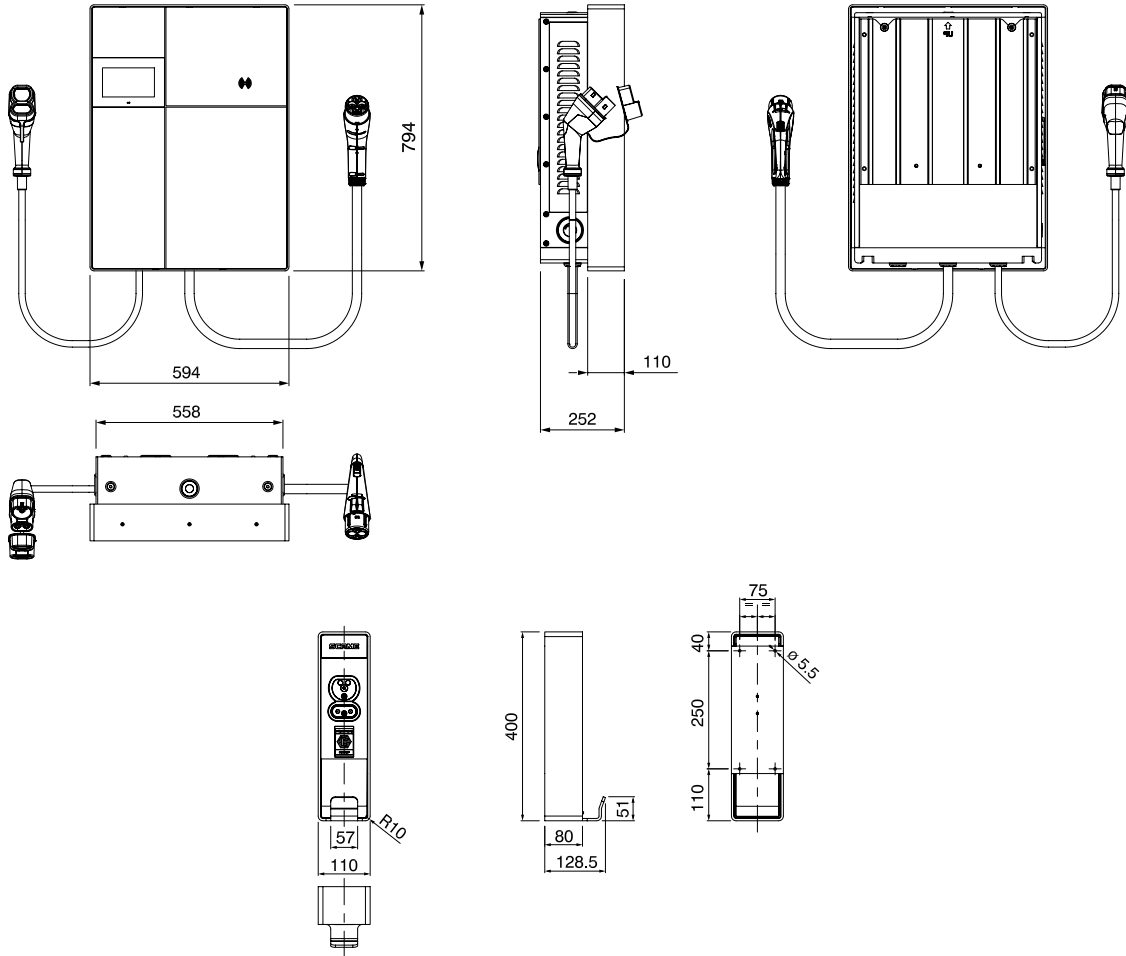

Code 208.AP60  
 208.AP61

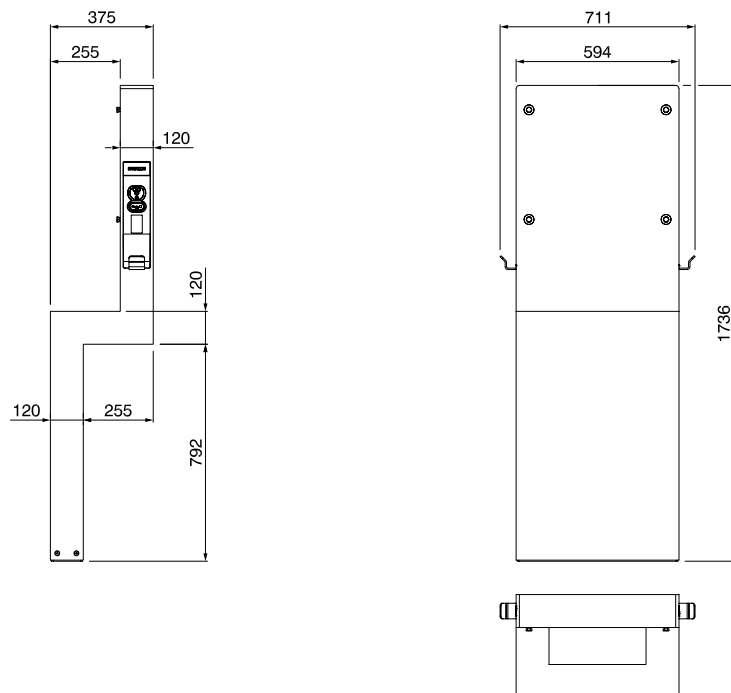

ZP01210-EN-1  
8 001636 416731



SCAME PARRE S.p.A.  
Via Costa Erta, 15 - 24020 Parre (BG) Italy  
Tel. +39 035 705000 - Fax +39 035 703122



[www.scame.com](http://www.scame.com)  
[export@scame.com](mailto:export@scame.com)

