

PRODUCT CATALOGUE
Katalog produktów



Furniture line

HOME | OFFICE | HOTEL

ORNO

Living innovations



more than
20
YEARS OF

Living innovations



> 80

WYKWALIFIKOWANYCH
PRACOWNIKÓW
Dedicated and qualified
employees



> 1700

POZYCJI
ASORTYMENTOWYCH
Assortment items



> 1500

REGULARNYCH
KLIENTÓW
Regular clients



> 1.3 mln.

PRODUKTÓW SPRZEDAWANYCH
ROCZNIE
Product sold annually



Jesteśmy polską, rodzinną firmą.
Od 2000 roku dostarczamy na rynek innowacyjne produkty,
a nasze nowe pomysły szybko przekuwamy w efektywne
i sprawdzone rozwiązania. Właśnie dlatego nasze produkty zyskały uznanie
i silną pozycję na rynku polskim i europejskim.

We are a Polish, family-owned company.
We have been supplying innovative products to the market since 2000,
and our new ideas are quickly converted into effective and proven solutions.
That is why our products have gained recognition
and a strong position on the Polish and European market.



Spis treści

QUICK FINDER

6

Gniazda wpuszczane

FLUSH MOUNTED SOCKETS



6-9



10



11



12



13



13



14



15-17



18-19



20



21



22



22



23-24



25



25



25

26

Gniazda nabołatowe

COUNTERTOP SOCKETS



26



27



28



29



30

31

Gniazda podszafkowe

UNDER-CABINET SOCKETS



31



32



33



34



35

36

Oświetlenie meblowe

FURNITURE LIGHTING



36



37



38

39

Sterowanie oświetleniem meblowym

AUTOMATION FOR FURNITURE LIGHTING CONTROL



39



39



39



39



39

40

Meblowe zasilacze LED

FURNITURE LED POWER SUPPLIES



40

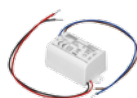

40

41

Rysunki techniczne

TECHNICAL DRAWINGS



Dostępne funkcje:

AVAILABLE FUNCTIONS



Materiał: stop cynku + blacha stalowa
Material: zinc alloy + steel sheet



Ładowarka USB
USB charger



Porty USB
USB ports



Naciśnij by otworzyć
Press to open



Warianty produktu:

AVAILABLE VARIANTS

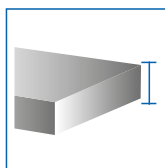









Gruby prostokątny rant - 7 mm
Thick rectangle edge - 7 mm



OR-AE-1335/G
OR-AE-1335/B
OR-AE-1338/G
OR-AE-1338/B



OR-AE-1324/G
OR-AE-1324/B

|  Symbol Product no |  EAN |  Ilość gniazd sieciowych Number of sockets |  Wersja french French type |  Porty USB USB ports |  Kabel zasilający Power cable |  Kolor Color |  szer./wys./gl. [mm] width x height x depth [mm] |
|---|--|---|---|---|---|---|---|
| OR-AE-1335/G | 5901752486690 | 3 x 2P+Z (max. 3600 W) | • | | | srebrny silver | 265 / 130 / 69 |
| OR-AE-1335/B | 5901752486683 | 3 x 2P+Z (max. 3600 W) | • | | | czarny black | 265 / 130 / 69 |
| OR-AE-1338/G | 5901752487109 | 3 x 2P+Z (max. 3600 W) | • | | • 1,5 m | srebrny silver | 265 / 130 / 69 |
| OR-AE-1338/B | 5901752487093 | 3 x 2P+Z (max. 3600 W) | • | | • 1,5 m | czarny black | 265 / 130 / 69 |
| OR-AE-1324/G | 5901752485747 | 2 x 2P+Z (max. 3600 W) | • | 3 x USB | | srebrny silver | 265 / 119 / 67 |
| OR-AE-1324/B | 5901752485730 | 2 x 2P+Z (max. 3600 W) | • | 3 x USB | | czarny black | 265 / 119 / 67 |

Brak ładowarki USB
No charger USB

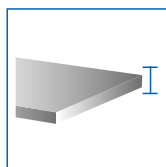









Cienki prostokątny rant - 2 mm
Thin rectangle edge - 2 mm



OR-AE-1371/G
OR-AE-1371(GS)/G
OR-AE-1372/G



OR-AE-1371/B
OR-AE-1371(GS)/B
OR-AE-1372/B

|  Symbol Product no |  EAN |  Ilość gniazd sieciowych Number of sockets |  Wersja french French type |  Wersja schuko Schuko type |  Kabel zasilający Power cable |  Kolor Color |  szer./wys./gl. [mm] width x height x depth [mm] |
|---|--|---|---|---|--|---|---|
| OR-AE-1371/G | 5901752488458 | 3 x 2P+Z (max. 3600W) | • | | | srebrny silver | 265 / 130 / 64 |
| OR-AE-1371(GS)/G | 5908254810831 | 3 x 2P+Z (max. 3600W) | | • | | srebrny silver | 265 / 130 / 64 |
| OR-AE-1371/B | 5901752488465 | 3 x 2P+Z (max. 3600W) | • | | | czarny black | 265 / 130 / 64 |
| OR-AE-1371(GS)/B | 5908254810824 | 3 x 2P+Z (max. 3600W) | | • | | czarny black | 265 / 130 / 64 |
| OR-AE-1372/G | 5901752488489 | 3 x 2P+Z (max. 3600W) | • | | • 1,5 m | srebrny silver | 265 / 130 / 64 |
| OR-AE-1372/B | 5901752488496 | 3 x 2P+Z (max. 3600W) | • | | • 1,5 m | czarny black | 265 / 130 / 64 |

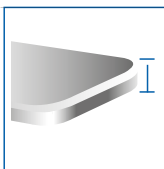

Cienki frezowany rant - 2 mm
Thin milled edge - 2 mm



OR-AE-1336/G
OR-AE-1336/G(GS)
OR-AE-1337/G
OR-AE-1337/G(GS)



OR-AE-1336/B
OR-AE-1336/B(GS)
OR-AE-1337/B
OR-AE-1337/B(GS)



OR-AE-1336/C
OR-AE-1337/C



OR-AE-1336/BR
OR-AE-1337/BR











OR-AE-1336/GR
OR-AE-1337/GR











OR-AE-13109/G
OR-AE-13126/G



OR-AE-13109/B
OR-AE-13126/B

|  Symbol Product no |  EAN |  Ilość gniazd sieciowych Number of sockets |  Wersja french French type |  Wersja schuko Schuko type |  Ładowarka USB USB charger |  Kabel zasilający Power cable |  Kolor Color |  szer./wys./gt. [mm] width x height x depth [mm] |
|---|--|---|---|---|---|--|---|---|
| OR-AE-1336/G | 5901752486935 | 3 x 2P+Z (max. 3600 W) | • | | | | srebrny silver | 265 / 119 / 67 |
| OR-AE-1336/G(GS) | 5902560328967 | 3 x 2P+Z (max. 3600 W) | | • | | | srebrny silver | 265 / 119 / 67 |
| OR-AE-1336/B | 5901752486942 | 3 x 2P+Z (max. 3600 W) | • | | | | czarny black | 265 / 119 / 67 |
| OR-AE-1336/B(GS) | 5902560328950 | 3 x 2P+Z (max. 3600 W) | | • | | | czarny black | 265 / 119 / 67 |
| OR-AE-1336/C | 5902560328929 | 3 x 2P+Z (max. 3600 W) | • | | | | złoty gold | 265 / 119 / 67 |

|  Symbol Product no |  EAN |  Ilość gniazd sieciowych Number of sockets |  Wersja french French type |  Wersja schuko Schuko type |  Ładowarka USB USB charger |  Kabel zasilający Power cable |  Kolor Color |  szer./wys./gt. [mm] width x height x depth [mm] |
|---|--|---|---|---|---|--|---|---|
| OR-AE-1336/BR | 5902560328936 | 3 x 2P+Z (max. 3600 W) | • | | | | mosiądz brass | 265 / 119 / 67 |
| OR-AE-1336/GR | 5902560328943 | 3 x 2P+Z (max. 3600 W) | • | | | | grafit graphite | 265 / 119 / 67 |
| OR-AE-1337/G | 5901752486959 | 3 x 2P+Z (max. 3600 W) | • | | | • 1,5 m | srebrny silver | 265 / 119 / 67 |
| OR-AE-1337/G(GS) | 5902560329063 | 3 x 2P+Z (max. 3600 W) | | • | | • 1,5 m | srebrny silver | 265 / 119 / 67 |
| OR-AE-1337/B | 5901752486966 | 3 x 2P+Z (max. 3600 W) | • | | | • 1,5 m | czarny black | 265 / 119 / 67 |
| OR-AE-1337/B(GS) | 5902560329056 | 3 x 2P+Z (max. 3600 W) | | • | | • 1,5 m | czarny black | 265 / 119 / 67 |
| OR-AE-1337/C | 5902560329025 | 3 x 2P+Z (max. 3600 W) | • | | | • 1,5 m | złoty gold | 265 / 119 / 67 |
| OR-AE-1337/BR | 5902560329032 | 3 x 2P+Z (max. 3600 W) | • | | | • 1,5 m | mosiądz brass | 265 / 119 / 67 |
| OR-AE-1337/GR | 5902560329049 | 3 x 2P+Z (max. 3600 W) | • | | | • 1,5 m | grafit graphite | 265 / 119 / 67 |
| OR-AE-13109/G | 5902560322064 | 2 x 2P+Z (max. 3600 W) | • | | • 2 x USB 5V DC / 2,1A | | srebrny silver | 265 / 119 / 67 |
| OR-AE-13109/B | 5902560322040 | 2 x 2P+Z (max. 3600 W) | • | | • 2 x USB 5V DC / 2,1A | | czarny black | 265 / 119 / 67 |
| OR-AE-13126/G | 5902560328455 | 2 x 2P+Z (max. 3600 W) | • | | • 2 x USB 5V DC / 2,1A | • 1,5 m | srebrny silver | 265 / 119 / 67 |
| OR-AE-13126/B | 5902560328066 | 2 x 2P+Z (max. 3600 W) | • | | • 2 x USB 5V DC / 2,1A | • 1,5 m | czarny black | 265 / 119 / 67 |

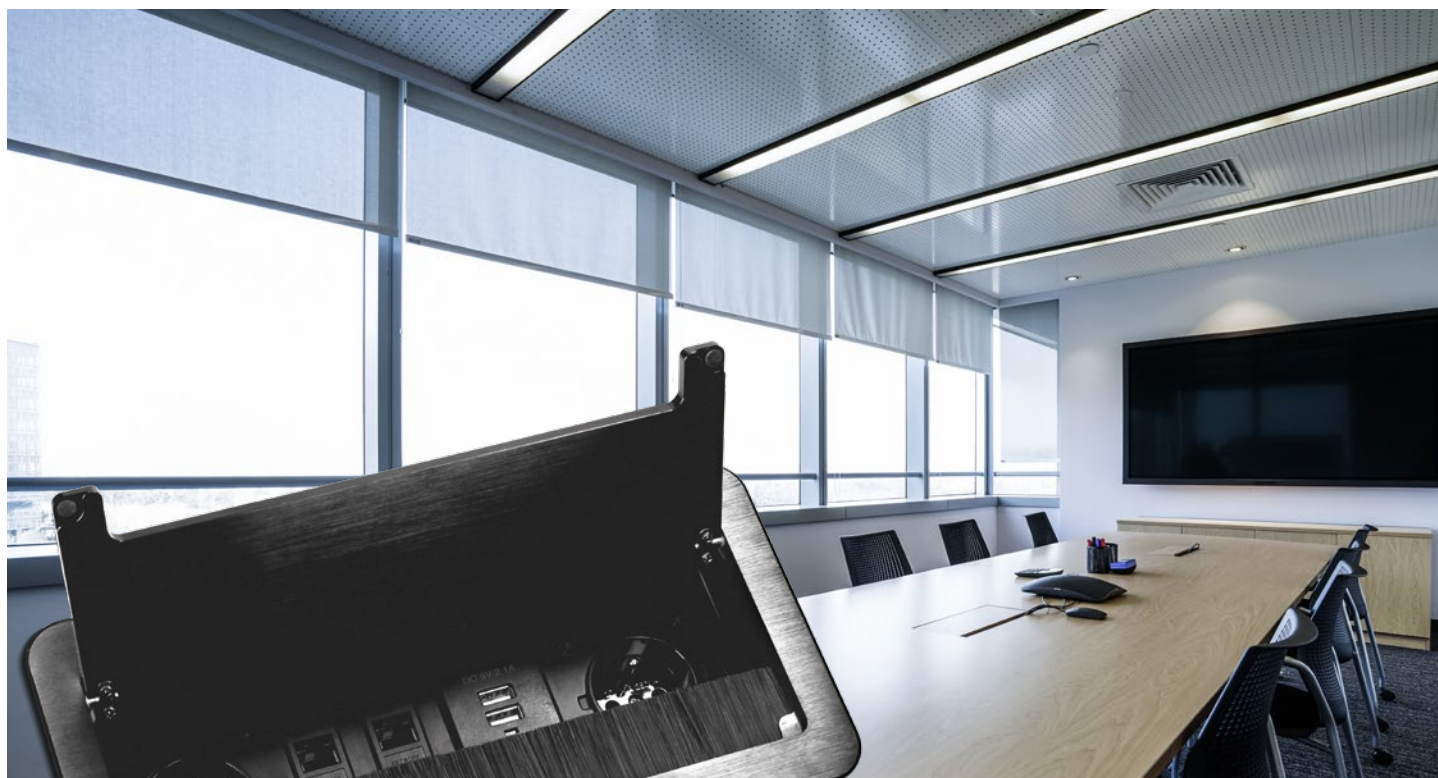

Dostępne funkcje:

AVAILABLE FUNCTIONS



Szczelina wykończona szczotką przeciwkurzową.
Anti-dust brush in the retractable top housing



Materiał: stop cynku + blacha stalowa
Material: zinc alloy + steel sheet



Gniazdo sieciowe RJ45
Network sockets RJ45



Ładowarka USB
USB charger



Cienki frezowany rant - 2mm
Thin milled edge - 2mm

Szczotkowana powierzchnia
Brushed finish



OR-AE-13127(GS)/B
OR-AE-13125/B
OR-AE-13125/B(GS)

| Symbol Product no | EAN | Ilość gniazd sieciowych Number of sockets | Wersja french French type | Wersja schuko Schuko type | Ładowarka USB USB charger | Gniazdo sieciowe Network socket | Kabel zasilający Power cable | szer./wys./gl. [mm] width x height x depth [mm] |
|----------------------|---------------|--|------------------------------|------------------------------|------------------------------|------------------------------------|---------------------------------|--|
| OR-AE-13127(GS)/B | 5902560328202 | 3 x 2P+Z (max. 3600 W) | | | | | • 1,5 m | 265 / 130 / 77 |
| OR-AE-13125/B | 5902560328684 | 2 x 2P+Z (max. 3600 W) | • | | • 2 x USB 5V DC / 2,1A | • 2 x RJ45 | • 1,5 m | 265 / 130 / 77 |
| OR-AE-13125/B(GS) | 5902560328042 | 2 x 2P+Z (max. 3600 W) | | • | • 2 x USB 5V DC / 2,1A | • 2 x RJ45 | • 1,5 m | 265 / 130 / 77 |



OR-AE-1361

Dostępne funkcje:

AVAILABLE FUNCTIONS



Szczelina wykończona szczotką przeciwkurzową.
Anti-dust brush in the retractable top housing









Materiał: tworzywo sztuczne
Material: plastic



Ładowarka USB
USB charger



OR-AE-1362

|  Symbol Product no |  EAN |  Ilość gniazd sieciowych Number of sockets |  Wersja french French type |  Ładowarka USB USB charger |  Kabel zasilający Power cable |  szer./wys./gł. [mm] width x height x depth [mm] |
|--|---|--|--|--|---|--|
| OR-AE-1361 | 5901752487710 | 3 x 2P+Z (max. 3680 W) | • | • | • 1,8 m | 228,5 / 158 / 80 |
| OR-AE-1362 | 5901752487727 | 3 x 2P+Z (max. 3680 W) | • | • 2 x USB 5V DC / 2,1A | • 1,8 m | 277,1 / 158 / 80 |



Dostępne funkcje:

AVAILABLE FUNCTIONS

- Materiał: tworzywo sztuczne + nikiel**
Material: plastic + nickel
- Naciśnij by otworzyć**
Press to open
- Ładowarka USB**
USB charger
- Cienki frezowany rant - 2mm**
Thin milled edge - 2mm



OR-AE-1363



OR-AE-1364

| Symbol Product no | EAN | Ilość gniazd sieciowych Number of sockets | Wersja french French type | Ładowarka USB USB charger | Kabel zasilający Power cable | szer./wys./gt. [mm] width x height x depth [mm] |
|--------------------------|---------------|--|----------------------------------|----------------------------------|-------------------------------------|--|
| OR-AE-1363 | 5901752487734 | 3 x 2P+Z (max. 3680 W) | • | • | • 1,8 m | 246 / 112 / 94 |
| OR-AE-1364 | 5901752487741 | 3 x 2P+Z (max. 3680 W) | • | • 2 x USB 5V DC / 2,1A | • 1,8 m | 286 / 112 / 94 |



OR-GM-9007/B-G

Dostępne funkcje:

AVAILABLE FUNCTIONS



Materiał: tworzywo sztuczne + aluminium
Material: plastic + aluminium



Przesuwna pokrywa
Sliding cover



OR-GM-9008/B-G

| Symbol Product no | EAN | Ilość gniazd sieciowych Number of sockets | Wersja french French type | Kabel zasilający Power cable | szer./wys./gt. [mm] width x height x depth [mm] |
|----------------------|---------------|--|------------------------------|---------------------------------|--|
| OR-GM-9007/B-G | 5901752487734 | 3 x 2P+Z (max. 3680 W) | • | | 230 / 98 / 60 |
| OR-GM-9008/B-G | 5901752487741 | 3 x 2P+Z (max. 3680 W) | • | 1,5 m | 230 / 98 / 60 |



Dostępne funkcje:

AVAILABLE FUNCTIONS



Materiał: tworzywo sztuczne + stal nierdzewna INOX
Material: plastic + stainless steel (INOX)



Naciśnij by otworzyć
Press to open

OR-GM-9014(GS)/B-G

| Symbol Product no | EAN | Ilość gniazd sieciowych Number of sockets | Wersja french French type | Wersja schuko Schuko type | Ładowarka USB USB charger | Kabel zasilający Power cable | szer./wys./gt. [mm] width x height x depth [mm] |
|----------------------|---------------|--|------------------------------|------------------------------|--|---------------------------------|--|
| OR-GM-9009/B-G | 5900378654872 | 3 x 2P+Z (max. 3680 W) | • | | • 2 x USB (typ A) 5V DC / 2,4A | • 2 m | 273,5 / 92,5 / 97,2 |
| OR-GM-9014(GS)/B-G | 5908254804137 | 3 x 2P+Z (max. 3680 W) | | • | • 2 x USB (typ A + C) 5V DC / 3,0A | • 2 m | 273,5 / 92,5 / 97,2 |





Dostępne funkcje:

AVAILABLE FUNCTIONS

- 

Mechanizm elektrycznego otwierania i zamykania
Electric opening and closing mechanism
- 

Inteligentny system ochrony zapobiegający przytrzaśnięciu
Intelligent anti-slam safety system
- 

Materiał: aluminium + tworzywo sztuczne
Material: aluminium + plastic
- 

Gniazdo sieciowe RJ45
Network sockets RJ45
- 

Gniazdo HDMI
HDMI socket
- 

Cienki frezowany rant - 2mm
Thin milled edge - 2mm



OR-AE-13110
OR-AE-13110(GS)

| Symbol Product no | EAN | Ilość gniazd sieciowych Number of sockets | Wersja french French type | Wersja schuko Schuko type | Gniazdo HDMI HDMI socket | Gniazdo sieciowe Network socket | Kabel zasilający Power cable | szer./wys./gt. [mm] width x height x depth [mm] |
|----------------------|---------------|--|------------------------------|------------------------------|-----------------------------|------------------------------------|---------------------------------|--|
| OR-AE-13110 | 5902560322088 | 3 x 2P+Z (max. 2500W) | • | | • 1 x HDMI | • 2 x RJ45 | • 1,5 m | 393 / 111 / 102 |
| OR-AE-13110(GS) | 5908254810855 | 3 x 2P+Z (max. 2500W) | | • | • 1 x HDMI | • 2 x RJ45 | • 1,5 m | 393 / 111 / 102 |



Gniazdo wpuszczane w blat. TAKIE JAK POTRZEBUJESZ.

Recessed furniture connection panel with socket modules of your own choice.



OR-GM-9010/W



OR-GM-9010/G



OR-GM-9010/B

NOEN kasetka meblowa wpuszczana w blat z wymienną ramką PVC

NOEN recessed furniture connection panel with a replaceable PVC frame

Pusta aluminiowa kasetka meblowa NOEN z wymienną ramką PVC wpuszczana w blat. Jest to uniwersalne rozwiązanie, które umożliwia zamocowanie 3 gniazd modułowych NOEN o wymiarach 45x45mm lub 6 gniazd o wymiarach 22,5x45mm (gniazda prądowe, HDMI, USB, RJ45, RJ11), w konfiguracji odpowiadającej preferencjom użytkownika. Urządzenie przeznaczone jest do montażu w biurkach, blatach i stołach. Posiada zamykaną pokrywę oraz przewód o długości 1,5m. Dostępne kolory: biały, czarny, srebrny.









Recessed furniture connection panel NOEN is composed of an empty aluminium case and a replaceable PVC frame. It is a convenient solution that enables installation of 3 NOEN socket or port modules (45x45mm each) or 6 modules (22.5x45mm each), in combination that suits preferences of the user (power sockets, HDMI, USB, RJ45, RJ11). This connection panel can be integrated into the surface of conference tables, office desks and kitchen tables. It has a protective cover and a cable 1.5m long. Available colours: white, black, silver.



Materiał: tworzywo sztuczne + aluminium
Material: plastic + aluminium



































































Cienki frezowany rant - 2mm
Thin milled edge - 2mm

|  Symbol Product no |  EAN |  Wymienne moduły Replaceable modules |  Kabel zasilający Power cable |  Kolor Color |  szer./wys./gł. [mm] width x height x depth [mm] |
|---|--|---|--|---|---|
|  OR-GM-9010/W | 5900378655893 | 3 x 45 mm lub / or 6 x 22,5 mm | • 1,5 m | biały white | 240 / 120 / 70 |
|  OR-GM-9010/G | 5900378655909 | 3 x 45 mm lub / or 6 x 22,5 mm | • 1,5 m | srebrny silver | 240 / 120 / 70 |
|  OR-GM-9010/B | 5900378655916 | 3 x 45 mm lub / or 6 x 22,5 mm | • 1,5 m | czarny black | 240 / 120 / 70 |

Dostępne gniazda oraz porty modułowe przeznaczone do kaset NOEN

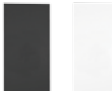
Socket modules and ports available for configuration of NOEN connection panels

|  Symbol Product no |  EAN |  Rodzaj gniazda Type of socket |  Kolor Color |  szer./wys. [mm] width x height [mm] |
|---|--|---|---|---|
|  OR-GM-9010/B/FR | 5900378655923 |  Wersja french French type | czarny black | 45 / 45 |
|  OR-GM-9010/W/FR | 5900378655930 |  Wersja french French type | biały white | 45 / 45 |
|  OR-GM-9010/B/FR45 | 5908254805554 |  Wersja french French type | czarny black | 45 / 45 |
|  OR-GM-9010/W/FR45 | 5908254805547 |  Wersja french French type | biały white | 45 / 45 |
|  OR-GM-9010/B/GS | 5900378655947 |  Wersja schuko Schuko type | czarny black | 45 / 45 |
|  OR-GM-9010/W/GS | 5900378655954 |  Wersja schuko Schuko type | biały white | 45 / 45 |
|  OR-GM-9010/B/GS45 | 5908254805578 |  Wersja schuko Schuko type | czarny black | 45 / 45 |
|  OR-GM-9010/W/GS45 | 5908254805561 |  Wersja schuko Schuko type | biały white | 45 / 45 |
|  OR-GM-9010/B/UK | 5900378655961 |  Wersja multifunkcyjna (UK, USA, AU, CN) Multifunctional type (UK, USA, AU, CN) | czarny black | 45 / 45 |
|  OR-GM-9010/B/USB | 5900378655978 |  1 x USB (5V DC / 2,1A) | czarny black | 22,5 / 45 |
|  OR-GM-9010/W/USB | 5900378655985 |  1 x USB (5V DC / 2,1A) | biały white | 22,5 / 45 |
|  OR-GM-9010/B/USBX2 | 5900378655992 |  2 x USB (5V DC / 2,1A) | czarny black | 45 / 45 |

| |  Symbol Product no |  EAN |  Rodzaj gniazda Type of socket |  Kolor Color |  szer./wys. [mm] width x height [mm] |
|---|---|--|---|---|---|
|  | OR-GM-9010/W/USBX2 | 5900378656005 |  2 x USB (5V DC / 2,1A) | biały white | 45 / 45 |
|  | OR-GM-9010/B/RJ45 | 5900378656012 |  Gniazdo sieciowe RJ45 Network socket RJ45 | czarny black | 45 / 45 |
|  | OR-GM-9010/W/RJ45 | 5900378656029 |  Gniazdo sieciowe RJ45 Network socket RJ45 | biały white | 22,5 / 45 |
|  | OR-GM-9010/B/RJ11 | 5900378656036 |  Gniazdo telefoniczne RJ11 Phone socket RJ45 | czarny black | 22,5 / 45 |
|  | OR-GM-9010/W/RJ11 | 5900378656043 |  Gniazdo telefoniczne RJ11 Phone socket RJ45 | biały white | 22,5 / 45 |
|  | OR-GM-9010/B/USBDATA | 5900378656050 |  USB DATA 2.0 (piny) USB DATA 2.0 (pins) | czarny black | 22,5 / 45 |
|  | OR-GM-9010/W/USBDATA | 5900378656067 |  USB DATA 2.0 (piny) USB DATA 2.0 (pins) | biały white | 22,5 / 45 |
|  | OR-GM-9010/B/USBDAT1 | 5908254810015 |  USB DATA 2.0 (przelotka) USB DATA 2.0 (double-sided) | czarny black | 22,5 / 45 |
|  | OR-GM-9010/W/USBDAT1 | 5908254810022 |  USB DATA 2.0 (przelotka) USB DATA 2.0 (double-sided) | biały white | 22,5 / 45 |
|  | OR-GM-9010/B/HDMI | 5900378656074 |  Gniazdo HDMI HDMI socket | czarny black | 22,5 / 45 |
|  | OR-GM-9010/W/HDMI | 5900378656081 |  Gniazdo HDMI HDMI socket | biały white | 22,5 / 45 |
|  | OR-GM-9010/B/USBQ | 5900378658658 |  1 x USB (3A / 5V; 2A / 9V; 1,5A / 12V) Instalacja: tylko z ramką bez separatorów 1 x USB (3A / 5V; 2A / 9V; 1,5A / 12V) Installation: only in frame without separators | czarny black | 45 / 45 |
|  | OR-GM-9010/W/USBQ | 5900378658641 |  1 x USB (3A / 5V; 2A / 9V; 1,5A / 12V) Instalacja: tylko z ramką bez separatorów 1 x USB (3A / 5V; 2A / 9V; 1,5A / 12V) Installation: only in frame without separators | biały white | 45 / 45 |
|  | OR-GM-9010/B/EP OR-GM-9010/W/EP | 5900378656098 5900378656104 |  Zaślepka Empty plate | czarny / black biały / white | 22,5 / 45 |
|  | OR-GM-9010/B/RM OR-GM-9010/W/RM | 5908254805530 5908254805523 |  Ramka bez separatorów do kaset Frame without separators | czarny / black biały / white | 175 / 59 |



Dostępne funkcje:

AVAILABLE FUNCTIONS



Ładowarka USB
USB charger



Naciśnij by otworzyć
Press to open

Opcje wykończenia:

FINISHING VARIANTS



Materiał: tworzywo sztuczne + metal lakierowany
Material: plastic + painted metal



Materiał: tworzywo sztuczne + stal nierdzewna INOX
Material: plastic + stainless steel (INOX)

Warianty produktu:

AVAILABLE VARIANTS



szer./wys./gt. [mm]
width x height x depth [mm]



| | |
|----------------------------------|-------------------|
| OR-AE-1347 | Ø 71,4 x 284 [mm] |
| OR-AE-1348 | |
| OR-AE-1347(GS) OR-AE-1348(GS) | |

| | |
|------------|---------------------|
| OR-AE-1349 | Ø 71,4 x 315,1 [mm] |
| OR-AE-1350 | |



szer./wys./gt. [mm]
width x height x depth [mm]



| | |
|------------|-----------------|
| OR-AE-1355 | Ø 90 x 284 [mm] |
| OR-AE-1356 | |

| | |
|------------|-----------------|
| OR-AE-1357 | Ø 90 x 322 [mm] |
|------------|-----------------|



szer./wys./gt. [mm]
width x height x depth [mm]



| | |
|------------|------------------|
| OR-AE-1351 | Ø 115 x 293 [mm] |
| OR-AE-1352 | |

| | |
|------------|------------------|
| OR-AE-1353 | Ø 115 x 339 [mm] |
| OR-AE-1354 | |

| | Symbol Product no | EAN | Otwór montażowy Mounting hole | Ilość gniazd sieciowych Number of sockets | French | Schuko | Ładowarka USB USB charger | Kolor / materiał Color / material | Przewód Cable |
|--|----------------------|---------------|----------------------------------|--|--------|--------|------------------------------|--|------------------|
| | OR-AE-1347 | 5901752487574 | Ø 60 mm | 3 x 2P+Z (max. 3680W) | • | | | metal lakierowany painted metal | • 1,8 m |
| | OR-AE-1347(GS) | 5908254810800 | Ø 60 mm | 3 x 2P+Z (max. 3680W) | | • | | metal lakierowany painted metal | • 1,8 m |
| | OR-AE-1348 | 5901752487581 | Ø 60 mm | 3 x 2tP+Z (max. 3680W) | • | | | stal nierdzewna INOX stainless steel (INOX) | • 1,8 m |
| | OR-AE-1348(GS) | 5908254810817 | Ø 60 mm | 3 x 2P+Z (max. 3680W) | | • | | stal nierdzewna INOX stainless steel (INOX) | • 1,8 m |
| | OR-AE-1349 | 5901752487598 | Ø 60 mm | 3 x 2P+Z (max. 3680W) | • | | • 2 x USB 5V DC / 2,1A | metal lakierowany painted metal | • 1,8 m |
| | OR-AE-1350 | 5901752487604 | Ø 60 mm | 3 x 2P+Z (max. 3680W) | • | | • 2 x USB 5V DC / 2,1A | stal nierdzewna INOX stainless steel (INOX) | • 1,8 m |
| | OR-AE-1355 | 5901752487659 | Ø 80 mm | 3 x 2P+Z (max. 3680W) | • | | | metal lakierowany painted metal | • 1,8 m |
| | OR-AE-1356 | 5901752487666 | Ø 80 mm | 3 x 2P+Z (max. 3680W) | • | | | stal nierdzewna INOX stainless steel (INOX) | • 1,8 m |
| | OR-AE-1357 | 5901752487673 | Ø 80 mm | 3 x 2P+Z (max. 3680W) | • | | • 2 x USB 5V DC / 2,1A | metal lakierowany painted metal | • 1,8 m |
| | OR-AE-1351 | 5901752487611 | Ø 100 mm | 3 x 2P+Z (max. 3680W) | • | | | metal lakierowany painted metal | • 1,8 m |
| | OR-AE-1352 | 5901752487628 | Ø 100 mm | 3 x 2P+Z (max. 3680W) | • | | | stal nierdzewna INOX stainless steel (INOX) | • 1,8 m |
| | OR-AE-1353 | 5901752487635 | Ø 100 mm | 3 x 2P+Z (max. 3680W) | • | | • 2 x USB 5V DC / 2,1A | metal lakierowany painted metal | • 1,8 m |
| | OR-AE-1354 | 5901752487642 | Ø 100 mm | 3 x 2P+Z (max. 3680W) | • | | • 2 x USB 5V DC / 2,1A | stal nierdzewna INOX stainless steel (INOX) | • 1,8 m |



Dostępne funkcje:

AVAILABLE FUNCTIONS



Ładowarka USB
USB charger



Naciśnij by otworzyć
Press to open

Warianty produktu:

AVAILABLE VARIANTS











Tworzywo sztuczne + metal lakierowany
Plastic + painted metal



Tworzywo sztuczne + stal nierdzewna INOX
Plastic + stainless steel (INOX)



szer./wys./gł. [mm]
width x height x depth [mm]
Ø 115 / 159,4

|  Symbol Product no |  EAN |  Otwór montażowy Mounting hole |  Ilość gniazd sieciowych Number of sockets |  Wersja french French type |  Wersja schuko Schuko type |  Ładowarka USB USB charger |  Kolor / materiał Color / material |  Kabel zasilający Power cable |
|--|---|--|--|--|---|--|--|---|
| OR-AE-1341 | 5901752487437 | Ø 100 mm | 4 x 2P+Z (max. 3680W) | • | | | metal lakierowany painted metal | • 1,5 m |
| OR-AE-1341(GS) | 5900378650850 | Ø 100 mm | 4 x 2P+Z (max. 3680W) | | • | | metal lakierowany painted metal | • 1,5 m |
| OR-AE-1342 | 5901752487444 | Ø 100 mm | 3 x 2P+Z (max. 3680W) | • | | • 2 x USB 5V DC / 2,4A | metal lakierowany painted metal | • 1,5 m |
| OR-AE-1342(GS) | 5900378650874 | Ø 100 mm | 3 x 2P+Z (max. 3680W) | | • | • 2 x USB 5V DC / 2,4A | metal lakierowany painted metal | • 1,5 m |
| OR-AE-1380 | 5901752489639 | Ø 100 mm | 4 x 2P+Z (max. 3680W) | • | | | stal nierdzewna INOX stainless steel (INOX) | • 1,5 m |
| OR-AE-1381 | 5901752489646 | Ø 100 mm | 3 x 2P+Z (max. 3680W) | • | | • 2 x USB 5V DC / 2,4A | stal nierdzewna INOX stainless steel (INOX) | • 1,5 m |
| OR-AE-1381(GS) | 5900378655718 | Ø 100 mm | 3 x 2P+Z (max. 3680W) | | • | • 2 x USB 5V DC / 2,4A | stal nierdzewna INOX stainless steel (INOX) | • 1,5 m |

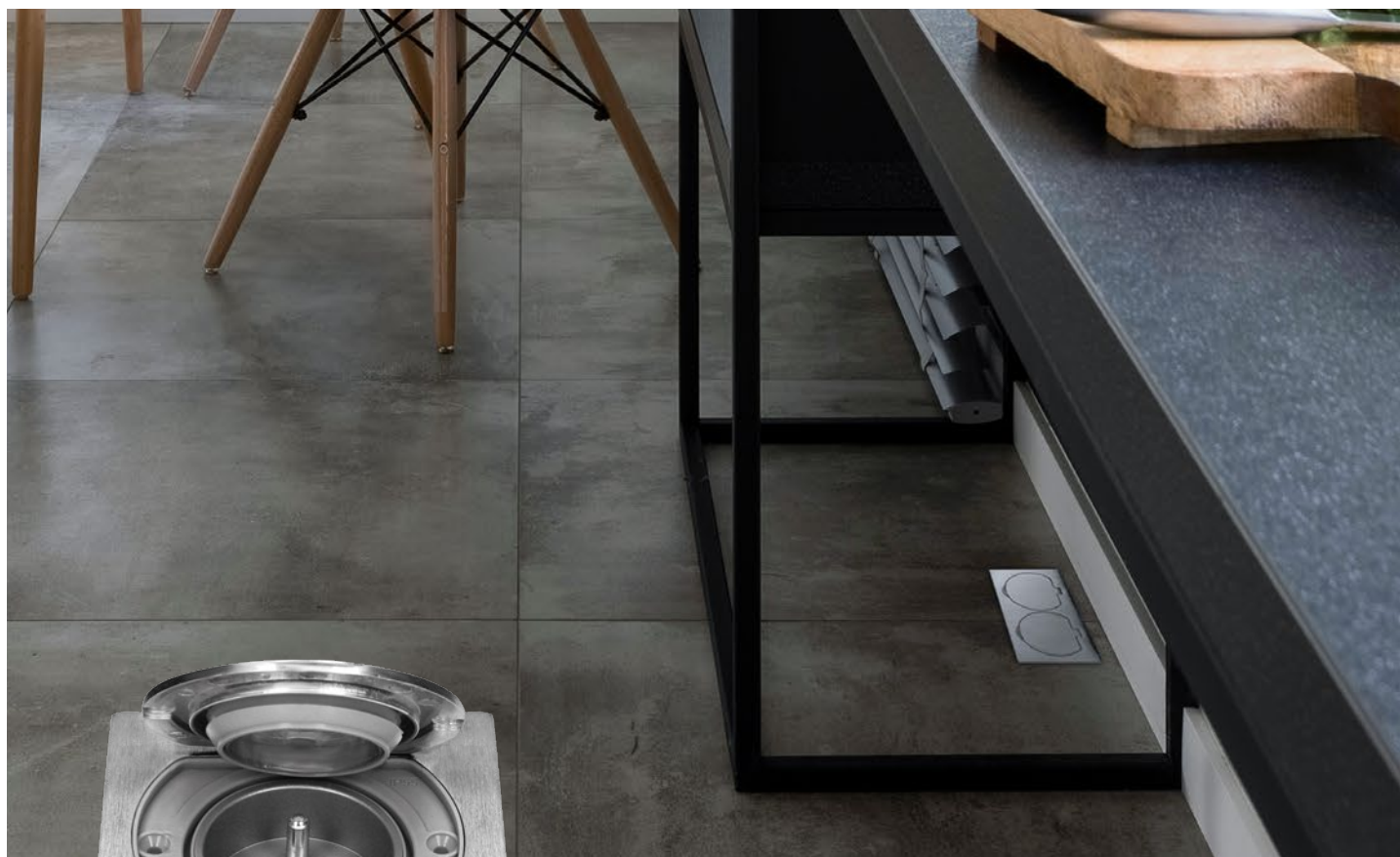

Materiał: stal nierdzewna
Material: stainless steel

OR-AE-1397
OR-AE-1397(GS)

Hermetyczne gniazdo elektryczne

Hermetic, flush-mounted socket



OR-AE-1398



Materiał: stal nierdzewna
Material: stainless steel



Montaż w standardowej puszcze elektrycznej Ø 60 mm.
Installation in a standard flush box, diameter Ø 60 mm



Kąt otwarcia pokrywy: 90°
Opening angle: 90°

| Symbol Product no | EAN | Ilość gniazd sieciowych Number of sockets | Wersja french French type | Wersja schuko Schuko type | Stopień ochrony Protection rating | szer./wys./gl. [mm] width x height x depth [mm] |
|----------------------|---------------|--|------------------------------|------------------------------|--------------------------------------|--|
| OR-AE-1397 | 5902560322101 | 1 x 2P+Z (max. 3680W) | • | | IP 55 | 85 / 85 / 57 |
| OR-AE-1397(GS) | 5908254810848 | 1 x 2P+Z (max. 3680W) | | • | IP 44 | 85 / 85 / 57 |
| OR-AE-1398 | 5902560322125 | 2 x 2P+Z (max. 3680W) | • | | IP 55 | 157 / 85 / 57 |



OR-AE-1373
OR-AE-1373(GS)



OR-AE-13124
OR-AE-13124(GS)





Materiał: tworzywo sztuczne
Material: plastic



Materiał: tworzywo sztuczne + stal nierdzewna
Material: plastic + stainless steel



Przesuwana pokrywa
Sliding cover

|  Symbol Product no |  EAN |  Ilość gniazd sieciowych Number of sockets |  Otwór montażowy Mounting hole |  Wersja french French type |  Wersja schuko Schuko type |  Ładowarka USB USB charger |  Kabel zasilający Power cable |  szer./wys./gł. [mm] width x height x depth [mm] |
|--|---|--|--|--|--|--|---|--|
| OR-AE-1373 | 5901752488427 | 1 x 2P+Z (max. 3680W) | Ø 60 mm | • | | 1 x USB 5V DC / 2,4 A | • 1,9 m | Ø70 / 83 |
| OR-AE-1373(GS) | 5902560326079 | 1 x 2P+Z (max. 3680W) | Ø 60 mm | | • | 1 x USB 5V DC / 2,4 A | • 1,9 m | Ø70 / 83 |
| OR-AE-13124 | 5902560327816 | 1 x 2P+Z (max. 3680W) | Ø 60 mm | • | | 1 x USB 5V DC / 2,4 A | • 1,9 m | 100 / 70 / 85 |
| OR-AE-13124(GS) | 5900378654896 | 1 x 2P+Z (max. 3680W) | Ø 60 mm | | • | 1 x USB 5V DC / 2,4 A | • 1,9 m | 100 / 70 / 85 |



Gniazdo meblowe Ø80mm wpuszczane w blat z ładowarką indukcyjną oraz ładowarką USB

Recessed desk socket Ø80mm with induction charger, USB charger

Kompaktowe gniazdo meblowe wpuszczane w blat można zastosować w każdym biurku. Posiada 1 gniazdo elektryczne, ładowarkę indukcyjną, szybką ładowarkę USB oraz dodatkowe wymienne moduły, dzięki którym w jednym miejscu podłączysz sprzęt różnego typu. Wyposażone w 1,8 m kabel.

This desk socket can be integrated in a surface of every desk or table. It houses 1 electric socket, induction charger, quick USB charger and other replaceable modules by means of which appliances of different types can be connected all in one place. The cable is 1.8 m long.

Dostępne funkcje:

AVAILABLE FUNCTIONS



Materiał: tworzywo sztuczne
Material: plastic



Ładowarka USB
USB charger



Ładowarka bezprzewodowa
Wireless charging



Wymienne moduły 1 x HDMI / RJ45 / USB
Replaceable modules 1 x HDMI / RJ45 / USB













OR-GM-9015/B

Ładowanie bezprzewodowe
Wireless charging 



















OR-GM-9015/W

Ładowanie bezprzewodowe
Wireless charging 

|  Symbol Product no |  EAN |  Ilość gniazd sieciowych Number of sockets |  Otwór montażowy Mounting hole |  Ładowarka USB USB charger |  French |  Schuko |  Przewód Cable |  Kolor Color |  szer./wys. [mm] width x height [mm] |
|---|--|---|---|---|---|---|---|---|---|
| OR-GM-9015/B | 5908254804823 | 1 x 2P+Z (max. 3680W) | Ø 80 mm | 2 x USB (typ A + C) 5V DC / 2,4 A | • | | • 1,8 m | czarny black | Ø 90 / 81 |
| OR-GM-9015/W | 5908254804816 | 1 x 2P+Z (max. 3680W) | Ø 80 mm | 2 x USB (typ A + C) 5V DC / 2,4 A | • | | • 1,8 m | biały white | Ø 90 / 81 |
| OR-GM-9015(GS)/B | 5908254810787 | 1 x 2P+Z (max. 3680W) | Ø 80 mm | 2 x USB (typ A + C) 5V DC / 2,4 A | | • | • 1,8 m | czarny black | Ø 90 / 81 |
| OR-GM-9015(GS)/W | 5908254810794 | 1 x 2P+Z (max. 3680W) | Ø 80 mm | 2 x USB (typ A + C) 5V DC / 2,4 A | | • | • 1,8 m | biały white | Ø 90 / 81 |

Dostępne gniazda oraz porty modułowe

Socket modules and ports available

|  Symbol Product no |  EAN |  Rodzaj gniazda Type of socket |  Kolor Color |  szer./wys./ gt. [mm] width x height x depth [mm] |
|---|--|---|---|--|
|  OR-GM-9011/B/RJ45 | 5900378656128 |  Gniazdo sieciowe RJ45 Network socket RJ45 | czarny black | 22,8 / 47 / 19,8 |
|  OR-GM-9011/W/RJ45 | 5900378656111 |  Gniazdo sieciowe RJ45 Network socket RJ45 | biały white | 22,8 / 47 / 19,8 |
|  OR-GM-9011/B/HDMI | 5900378656142 |  Gniazdo HDMI HDMI socket | czarny black | 22,8 / 47 / 19,8 |
|  OR-GM-9011/W/HDMI | 5900378656135 |  Gniazdo HDMI HDMI socket | biały white | 22,8 / 47 / 19,8 |
|  OR-GM-9011/B/USB | 5900378656166 |  USB DATA USB DATA | czarny black | 22,8 / 47 / 19,8 |
|  OR-GM-9011/W/USB | 5900378656159 |  USB DATA USB DATA | biały white | 22,8 / 47 / 19,8 |

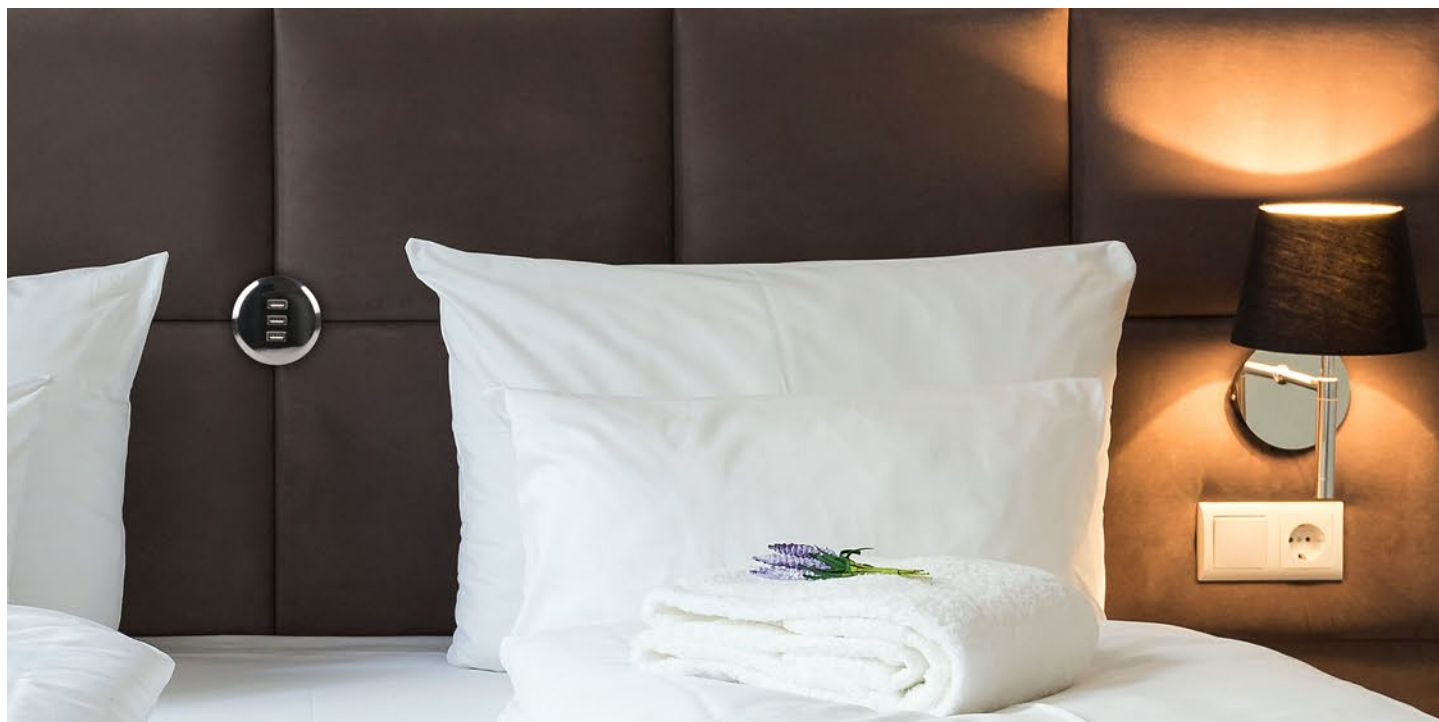

Ładowarki USB

USB chargers



OR-AE-1368/B
OR-AE-1368/G



Materiał: tworzywo sztuczne
Material: plastic



OR-GM-9013/B













Materiał: stop cynku + tworzywo sztuczne
Material: zinc alloy + plastic



OR-AE-1367/B
OR-AE-1367/G
OR-AE-1367/W



Materiał: tworzywo sztuczne
Material: plastic

| |  Symbol Product no |  EAN |  Otwór montażowy Mounting hole |  Ładowarka USB USB charger |  Ładowanie bezprzewodowe Wireless charging |  Kolor / materiał Color / material |  Kabel zasilający Power cable |  szer./wys./gł. [mm] width x height x depth [mm] |
|---|--|---|--|--|--|--|---|--|
|  | OR-AE-1368/B | 5901752488328 | Ø 25 mm | 2 x USB 5V DC / 2,1 A | | czarny black | | Ø 37 / 29,5 |
| | OR-AE-1368/G | 5901752488182 | Ø 25 mm | 2 x USB 5V DC / 2,1 A | | srebrny silver | | Ø 37 / 29,5 |
|  | OR-GM-9013/B | 5908254802386 | Ø 60 mm | 3 x USB 5V DC / 3,1 A | | czarny połysk black gloss | • 1,5 m | Ø 70 / 55 |
|  | OR-AE-1367/B | 5901752488144 | Ø 60 mm | 1 x USB 5V DC / 2,1 A | • | czarny black | | Ø 70 / 22 |
| | OR-AE-1367/G | 5901752488151 | Ø 60 mm | 1 x USB 5V DC / 2,1 A | • | srebrny silver | | Ø 70 / 22 |
| | OR-AE-1367/W | 5901752488168 | Ø 60 mm | 1 x USB 5V DC / 2,1 A | • | biały white | | Ø 70 / 22 |



Dostępne funkcje:

AVAILABLE FUNCTIONS



Materiał: tworzywo sztuczne
Material: Plastic



Ładowarka USB
USB charger



Montaż: zacisk śrubowy
Installation: clamp holder



OR-AE-13197/B
OR-AE-13133(GS)/B



OR-AE-13197/W
OR-AE-13133(GS)/W

Warianty produktu:

AVAILABLE VARIANTS

| Symbol Product no | EAN | Ilość gniazd sieciowych Number of sockets | Wersja french French type | Wersja schuko Schuko type | Ładowarka USB USB charger | Kabel zasilający Power cable | Kolor Color | szer./wys./gł. [mm] width x height x depth [mm] |
|----------------------|---------------|--|------------------------------|------------------------------|------------------------------|------------------------------------|-----------------|--|
| OR-AE-13197/W | 5900378653110 | 2 x 2P+Z (max. 2300W) | • | | • 2 x USB 5V DC / 2,4A | • 1,4 m (3x1,0mm ²) | biały white | 164 / 67 / 58 |
| OR-AE-13197/B | 5908254803628 | 2 x 2P+Z (max. 2300W) | • | | • 2 x USB 5V DC / 2,4A | • 1,4 m (3x1,0mm ²) | czarny black | 164 / 67 / 58 |
| OR-AE-13133(GS)/W | 5908254811012 | 2 x 2P+Z (max. 3680W) | | • | • 2 x USB 5V DC / 2,4A | • 1,4 m (3x1,5mm ²) | biały white | 164 / 67 / 58 |
| OR-AE-13133(GS)/B | 5908254800535 | 2 x 2P+Z (max. 3680W) | | • | • 2 x USB 5V DC / 2,4A | • 1,4 m (3x1,5mm ²) | czarny black | 164 / 67 / 58 |



OR-AE-13100



OR-AE-13101



OR-AE-13103

Dostępne funkcje:

AVAILABLE FUNCTIONS



Materiał: tworzywo sztuczne + metal lakierowany
Material: plastic + painted metal



Montaż: zacisk śrubowy
Installation: clamp holder

Warianty produktu:

AVAILABLE VARIANTS

| Symbol Product no | EAN | Ilość gniazd sieciowych Number of sockets | Wersja french French type | Ładowarka USB USB charger | Kabel zasilający Power cable | szer./wys./gl. [mm] width x height x depth [mm] |
|----------------------|---------------|--|------------------------------|------------------------------|---------------------------------|--|
| OR-AE-13100 | 5902560320275 | 3 x 2P+Z (max. 3680W) | • | | • 1,8 m | 180 / 180 / 67 |
| OR-AE-13101 | 5902560320282 | 3 x 2P+Z (max. 3680W) | • | • 2 x USB 5V DC / 2,1A | • 1,8 m | 225 / 180 / 67 |
| OR-AE-13103 | 5902560320305 | 4 x 2P+Z (max. 3680W) | • | • 2 x USB 5V DC / 2,1A | • 1,8 m | 268 / 180 / 67 |

Prosty montaż

Zestaw gniazd sieciowych z uziemieniem i przesłonami torów prądowych w metalowej obudowie wyposażonej w zacisk śrubowy, który umożliwia przytwierdzenie podstawy gniazd do krawędzi blatu biurka lub półki bez konieczności wiercenia otworów montażowych.

Easy installation

Set of power sockets with grounding and safety shutters, built in a metal case. Easy installation by means of table clamp holders. The socket base can be attached to the edge of a desk top or a shelf, without the necessity of drilling any holes.



Dostępne funkcje:

AVAILABLE FUNCTIONS



Materiał: tworzywo sztuczne + metal lakierowany
Material: plastic + painted metal



Montaż: zacisk śrubowy
Installation: clamp holder



Warianty produktu:

AVAILABLE VARIANTS

| Symbol Product no | EAN | Ilość gniazd sieciowych Number of sockets | Wersja french French type | Ładowarka USB USB charger | Kabel zasilający Power cable | szer./wys./gt. [mm] width x height x depth [mm] |
|----------------------|---------------|--|------------------------------|------------------------------|---------------------------------|--|
| OR-AE-13105 | 5902560320329 | 3 x 2P+Z (max. 3680W) | • | • 2 x USB 5V DC / 2,1A | • 1,8 m | 210 / 77 / 82 |

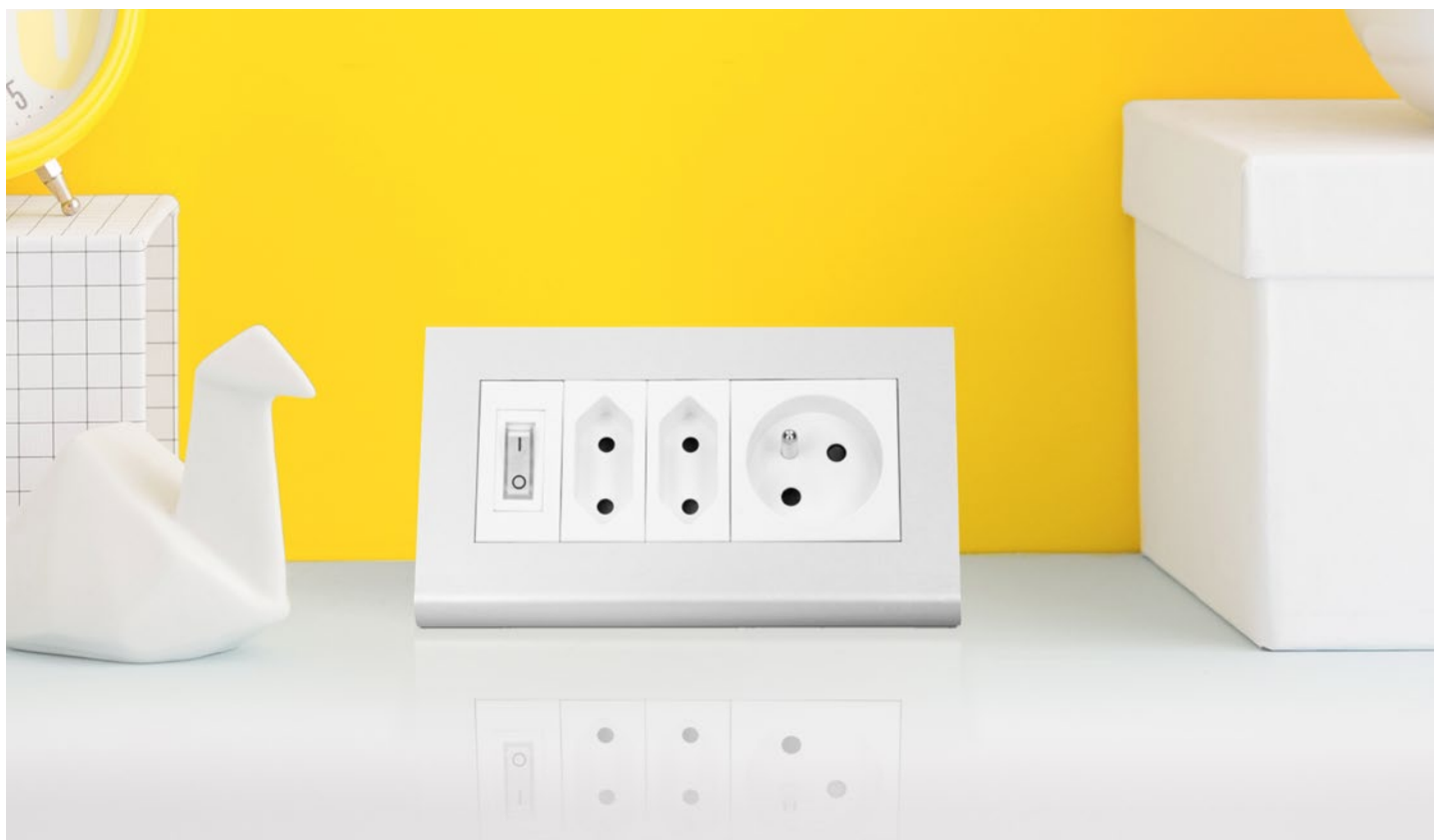

OR-AE-1327



Materiał: tworzywo sztuczne + metal lakierowany
Material: plastic + painted metal

OR-AE-1328



Materiał: tworzywo sztuczne + metal lakierowany
Material: plastic + painted metal



Włącznik On / Off
On / Off button

Warianty produktu:

AVAILABLE VARIANTS

| Symbol Product no | EAN | Ilość gniazdek sieciowych Number of sockets | Wersja french French type | Ładowarka USB USB charger | Kabel zasilający Power cable | szer./wys./gł. [mm] width x height x depth [mm] |
|----------------------|---------------|--|------------------------------|------------------------------|---------------------------------|--|
| OR-AE-1327 | 5901752486201 | 1 x 2P+Z, french / 2 x 2P/II (Max. 3500W) | french typ E / typ euro | | 1,5 m | 155 / 92 / 80 |
| OR-AE-1328 | 5901752486195 | 1 x 2P+Z, french / 1 x 2P/II (Max. 3500W) | french typ E / typ euro | 1 x USB 5V DC / 2,1A | 1,5 m | 155 / 92 / 80 |











Przedłużacz 4-krotny z ładowarką USB szaro-biały

4 Extension sockets with USB charger, grey-white

Nowoczesny przedłużacz sieciowy z innowacyjnym systemem mocującym, który umożliwia montaż na płaszczyznach poziomych i pionowych w trudno dostępnych miejscach np. do ściany lub pod powierzchnią blatu. Urządzenie posiada cztery gniazda sieciowe z uziemieniem i przesłonami torów prądowych, ładowarkę do wszelkiego typu telefonów, smartfonów, tableatów i innych urządzeń ładowanych przez port USB oraz przewód o długości 1,4m.

Modern extension sockets with an innovative fastening system that allows mounting in horizontal and vertical positions in hard-to-reach places, for instance: to the wall or under the worktop surface. The device has four power sockets with grounding and safety shutters, and a charger for all types of phones, smartphones, tablets and other devices charged via USB port. The cable is 1.4m long.



|  Symbol Product no |  EAN |  Ilość gniazd sieciowych Number of sockets |  Wersja french French type |  Wersja schuko Schuko type |  Ładowarka USB USB charger |  Kabel zasilający Power cable |  szer./wys./gł. [mm] width x height x depth [mm] |
|--|---|--|--|--|---|---|--|
| OR-AE-13144 | 5900378654643 | 4 x 2P+Z (max. 2300W) | • | | • 2 x USB 5V DC / 2,1A | • 1,4 m (3x1,0mm ²) | 77 x 77 x 77 |
| OR-AE-13144(GS) | 5908254803260 | 4 x 2P+Z (max. 2300W) | | • | • 2 x USB 5V DC / 2,1A | • 1,4 m (3x1,0mm ²) | 77 x 77 x 77 |



OR-GM-9012/G



Materiał: tworzywo sztuczne
Material: plastic



Gniazdo hermetyczne IP44
Hermetic IP44



OR-AE-1383



Materiał: tworzywo sztuczne
Material: plastic



Przesłony torów prądowych
Safety shutters









OR-AE-1382



Materiał: tworzywo sztuczne
Material: plastic



Gniazdo hermetyczne IP44
Hermetic IP44

|  Symbol Product no |  EAN |  Ilość gniazd sieciowych Number of sockets |  Wersja french French type |  Kabel zasilający Power cable |  szer./wys./gl. [mm] width x height x depth [mm] |
|---|--|---|---|--|---|
| OR-GM-9012/G | 5900378658146 | 1 x 2P+Z (max. 3680W) | • | • 0,5 m | 60 / 60 / 75 |
| OR-AE-1383 | 5901752489776 | 2 x 2P+Z (max. 3680W) | • | • 0,5 m | 140 / 62 / 45 |
| OR-AE-1382 | 5901752489769 | 2 x 2P+Z (max. 3680W) | • | • 0,5 m | 140,5 / 64 / 49 |



Dostępne funkcje:

AVAILABLE FUNCTIONS



Materiał: tworzywo sztuczne + aluminium
Material: plastic + aluminium



Ładowarka USB
USB charger



Włącznik On / Off
On / Off button



Montaż: pion / poziom
Installation: vertical / horizontal

Warianty produktu:

AVAILABLE VARIANTS



OR-AE-1303/G
OR-AE-1303/G(GS)
OR-AE-1303/B



OR-AE-1310
OR-AE-1310(GS)













OR-AE-1302



OR-AE-1304
OR-AE-1304(GS)

| Symbol Product no | EAN | Ilość gniazd sieciowych Number of sockets | Wersja french French type | Wersja schuko Schuko type | Ładowarka USB USB charger | Wyłącznik On/Off On/Off button | Kabel zasilający Power cable | Kolor Color | szer./wys./gi. [mm] width x height x depth [mm] |
|----------------------|---------------|--|------------------------------|------------------------------|------------------------------|-----------------------------------|---------------------------------|-------------------|--|
| OR-AE-1303/G | 5901752483415 | 2 x 2P+Z (max. 3680W) | • | | | | • 0,5 m | srebrny silver | 150 / 64 / 64 |
| OR-AE-1303/G(GS) | 5902560320749 | 2 x 2P+Z (max. 3680W) | | • | | | • 0,5 m | srebrny silver | 150 / 64 / 64 |
| OR-AE-1303/B | 5902560328516 | 2 x 2P+Z (max. 3680W) | • | | | | • 0,5 m | czarny black | 150 / 64 / 64 |
| OR-AE-1310 | 5901752484047 | 1 x 2P+Z (max. 3680W) | • | | • 2 x USB 5V DC / 2,1A | | • 0,5 m | srebrny silver | 150 / 64 / 64 |

|  Symbol Product no |  EAN |  Ilość gniazd sieciowych Number of sockets |  Wersja french French type |  Wersja schuko Schuko type |  Ładowarka USB USB charger |  Wyłącznik On/Off On/Off button |  Kabel zasilający Power cable |  Kolor Color |  szer./wys./gt. [mm] width x height x depth [mm] |
|--|---|--|--|--|--|--|---|--|--|
| OR-AE-1310(GS) | 5902560325911 | 1 x 2P+Z (max. 3680W) | | • | • 2 x USB 5V DC / 2,1A | | • 0,5 m | srebrny silver | 150 / 64 / 64 |
| OR-AE-1302 | 5901752483422 | 1 x 2P+Z (max. 3680W) | • | | | • | • 0,5 m | srebrny silver | 150 / 64 / 64 |
| OR-AE-1304 | 5901752483514 | 2 x 2P+Z (max. 3680W) | • | | | • | • 0,5 m | srebrny silver | 275 / 64 / 64 |
| OR-AE-1304(GS) | 5902560322248 | 2 x 2P+Z (max. 3680W) | | • | | • | • 0,5 m | srebrny silver | 275 / 64 / 64 |



OR-GM-9005/W-G
OR-GM-9005/W-G(GS)









OR-GM-9001/B-G
OR-GM-9001/B-G(GS)
OR-GM-9001/W-G
OR-GM-9001/W-G(GS)



OR-GM-9003/W-G
OR-GM-9003/W-G(GS)



OR-GM-9002/B-G
OR-GM-9002/B-G(GS)
OR-GM-9002/W-G
OR-GM-9002/W-G(GS)

|  Symbol Product no |  EAN |  Ilość gniazd sieciowych Number of sockets |  Wersja french French type |  Wersja schuko Schuko type |  Ładowarka USB USB charger |  Wyłącznik On/Off On/Off button |  Kabel zasilający Power cable |  Kolor Color |  szer./wys./gt. [mm] w x h x d [mm] |
|--|---|--|--|--|--|---|---|--|---|
| OR-GM-9005/W-G | 5902560329759 | 2 x 2P+Z (max. 3680W) | • | | | | • 0,6 m | biały white | 150 / 64 / 64 |
| OR-GM-9005/W-G(GS) | 5902560329742 | 2 x 2P+Z (max. 3680W) | | • | | | • 0,6 m | biały white | 150 / 64 / 64 |
| OR-GM-9001/B-G | 5902560329766 | 3 x 2P+Z (max. 3680W) | • | | | | • 0,6 m | czarny black | 200 / 64 / 64 |
| OR-GM-9001/B-G(GS) | 5902560329773 | 3 x 2P+Z (max. 3680W) | | • | | | • 0,6 m | czarny black | 200 / 64 / 64 |
| OR-GM-9001/W-G | 5902560329780 | 3 x 2P+Z (max. 3680W) | • | | | | • 0,6 m | biały white | 200 / 64 / 64 |
| OR-GM-9001/W-G(GS) | 5902560329797 | 3 x 2P+Z (max. 3680W) | | • | | | • 0,6 m | biały white | 200 / 64 / 64 |
| OR-GM-9003/W-G | 5902560329841 | 2 x 2P+Z (max. 3680W) | • | | • 2 x USB 5V DC / 2,1A | | • 0,6 m | biały white | 198 / 64 / 64 |
| OR-GM-9003/W-G(GS) | 5902560329858 | 2 x 2P+Z (max. 3680W) | | • | • 2 x USB 5V DC / 2,1A | | • 0,6 m | biały white | 198 / 64 / 64 |
| OR-GM-9002/B-G | 5902560329803 | 2 x 2P+Z (max. 3680W) | • | | | • | • 0,6 m | czarny black | 210 / 64 / 64 |
| OR-GM-9002/B-G(GS) | 5902560329810 | 2 x 2P+Z (max. 3680W) | | • | | • | • 0,6 m | czarny black | 210 / 64 / 64 |
| OR-GM-9002/W-G | 5902560329827 | 2 x 2P+Z (max. 3680W) | • | | | • | • 0,6 m | biały white | 210 / 64 / 64 |
| OR-GM-9002/W-G(GS) | 5902560329834 | 2 x 2P+Z (max. 3680W) | | • | | • | • 0,6 m | biały white | 210 / 64 / 64 |



Dostępne funkcje:

AVAILABLE FUNCTIONS



Materiał: stal nierdzewna (INOX)
Material: stainless steel (INOX)



Montaż: pion / poziom
Installation: vertical / horizontal

Prosty montaż

Zestaw czterech gniazd sieciowych z uziemieniem i przesłonami torów prądowych w obudowie ze stali nierdzewnej INOX. Idealny do montażu w kuchni i biurze, na powierzchniach płaskich i w narożnikach za pomocą pasków samoprzylepnych z rzepami lub wkrętów. Zalecany przewód OWY 3 x 1,5 mm² (brak w zestawie).









Easy installation

A set of four power sockets with earthing and safety shutters, in a stainless steel (INOX) case. Designed for indoor installation on flat surfaces and in corners. It can be easily mounted using self-adhesive strips or traditionally – using screws. Recommended cable: OWY 3 x 1.5mm² (not included).

Warianty produktu:

AVAILABLE VARIANTS

|  Symbol Product no |  EAN |  Ilość gniazd sieciowych Number of sockets |  Wersja french French type |  Wersja schuko Schuko type |  Kabel zasilający Power cable |  szer./wys./gl. [mm] width x height x depth [mm] |
|---|--|---|---|--|--|---|
| OR-AE-1340 | 5901752487420 | 4 x 2P+Z (max. 3680W) | • | | | 280 / 95 / 48 |
| OR-AE-1340(GS) | 5900378653899 | 4 x 2P+Z (max. 3680W) | | • | | 280 / 95 / 48 |



Dostępne funkcje:

AVAILABLE FUNCTIONS



Materiał: tworzywo sztuczne + metal lakierowany
Material: plastic + painted metal



Ładowarka USB
USB charger



Montaż: pion / poziom
Installation: vertical / horizontal



OR-AE-1359

OR-AE-1360

Warianty produktu:

AVAILABLE VARIANTS

| Symbol Product no | EAN | Ilość gniazd sieciowych Number of sockets | Wersja french French type | Ładowarka USB USB charger | Kabel zasilający Power cable | szer./wys./gt. [mm] width x height x depth [mm] |
|----------------------|---------------|--|------------------------------|------------------------------|---------------------------------|--|
| OR-AE-1359 | 5901752487697 | 3 x 2P+Z (max. 3680W) | • | • | • 1,8 m | 234 / 99,5 / 56,5 |
| OR-AE-1360 | 5901752487703 | 3 x 2P+Z (max. 3680W) | • | • 2 x USB 5V DC / 2,1A | • 1,8 m | 276 / 99,5 / 56,5 |



OR-OL-6099LZM4
OR-OL-6100LZM4
OR-OL-6101LZM4
OR-OL-6102LZM4

NOTUS LED oprawy liniowe podszafkowe

LED linear fixture NOTUS



OR-OL-6099CN

PRZEWÓD ŁĄCZENIOWY

Connection cable



OR-OL-6099PZ

PRZEWÓD ZASILAJĄCY

Power cord

Oprawy liniowe podszafkowe są idealnym rozwiązaniem do podświetlenia blatów i szafek kuchennych, regałów, gablot i witryn sklepowych lub biur. Można je montować we wszystkich miejscach gdzie potrzebne jest oświetlenie liniowe. Zastosowane nowoczesne diody LED SMD gwarantują dużą energooszczędność i długą żywotność urządzenia. Każda oprawa wyposażona jest w indywidualny wyłącznik ON/OFF, gniazdo oraz wtyk 2-pinowy. Dzięki układowi przelotowych złącz posiada możliwość łączenia w szereg – linię świetlną. Materiał: tworzywo sztuczne.

Our linear fixtures are perfect solution to provide light to tabletops and cupboards in your kitchen or your office. They can be installed in all places where linear lighting is required, such as cabinets and shop displays. The use of LED technology guarantees high energy efficiency and long service life. Each fixture is equipped with an individual ON/OFF switch, a socket and 2-pin connector plug. Thanks to the system of pass-through connectors, it is possible to connect the fixtures in series – a light line. Material: plastic.



230V~, 50Hz



LED SMD



IP20



On / Off



Materiał: tworzywo sztuczne

Material: plastic

| Symbol Product no | EAN | Moc Rated power | Ra/CRI Współczynnik oddawania barw Ra/CRI Color rendering index (ra) | Strumień świetlny Luminous flux | Temperatura barwowa Color temperature | Kabel zasilający Power cable | szer./wys./gł. [mm] width x height x depth [mm] |
|----------------------|---------------|--------------------|--|------------------------------------|--|---------------------------------|--|
| OR-OL-6099LZM4 | 5902560329292 | 4 W | >70 | 360 lm | 4000 K | | 310 / 26 / 37 |
| OR-OL-6100LZM4 | 5902560329308 | 7 W | >70 | 630 lm | 4000 K | | 560 / 26 / 37 |
| OR-OL-6101LZM4 | 5902560329315 | 10 W | >70 | 900 lm | 4000 K | | 864 / 26 / 37 |
| OR-OL-6102LZM4 | 5902560329322 | 14 W | >70 | 1260 lm | 4000 K | | 1174 / 26 / 37 |
| OR-OL-6099PZ | 5900378654520 | | | | | • 98 cm | |
| OR-OL-6099CN | 5902560329339 | | | | | • 16 cm | |



Warianty produktu:

AVAILABLE VARIANTS



OR-AE-13108



Materiał: stal lakierowana
Material: painted steel



Rodzaj włącznika: bezdotykowy
Type of switch: touchless



OR-AE-13118



Materiał: stal nierdzewna (INOX)
Material: stainless steel (INOX)



Rodzaj włącznika: bezdotykowy
Type of switch: touchless

| Symbol Product no | EAN | Moc Rated power | Źródło światła Light source | Temperatura barwowa Color temperature | Kolor Color | szer./wys./gt. [mm] width x height x depth [mm] |
|----------------------|---------------|--------------------|--------------------------------|--|----------------|--|
| OR-AE-13108 | 5902560321395 | 2,5 W | LED SMD | 4000 K | biały white | 80 / 120 / 50 |
| OR-AE-13118 | 5902560327090 | 2,5 W | LED SMD | 4000 K | inox | 80 / 120 / 50 |

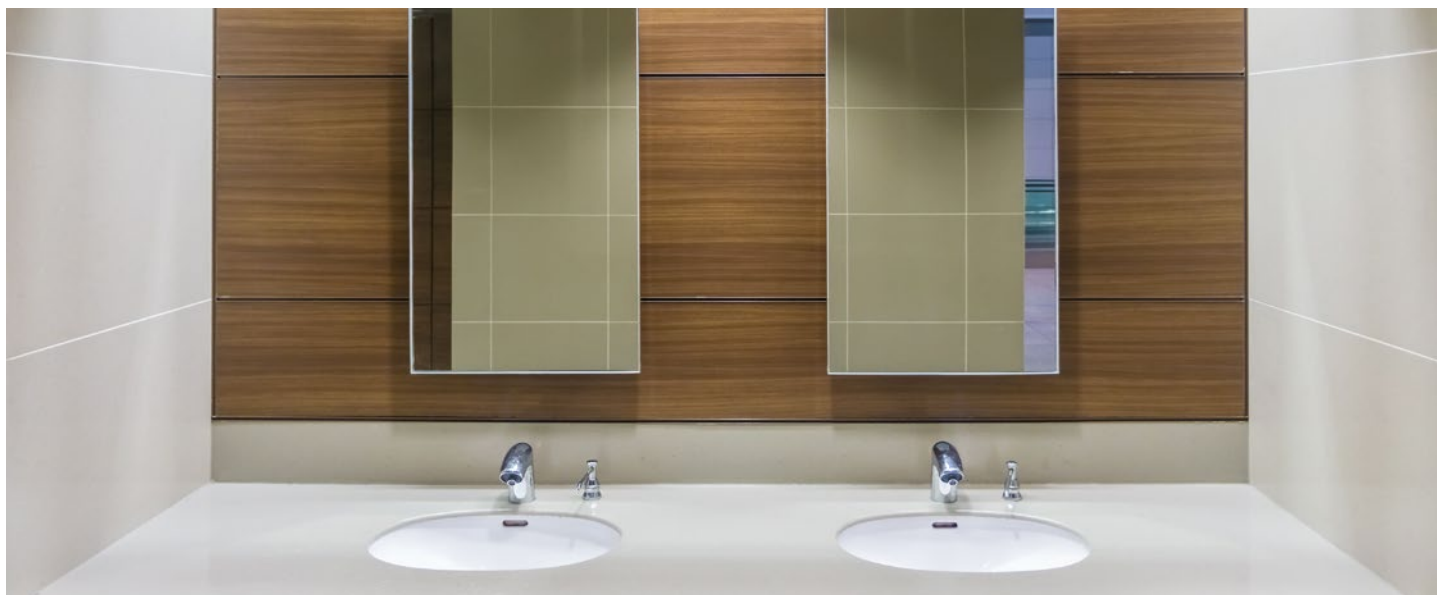

Lampy nad lustro

Mirror lamps



OR-OM-6120L4



OR-OM-6104L4











OR-OM-6121L4



OR-OM-6122L4



OR-OM-6123L4

|  Symbol Product no |  EAN |  Moc Rated power |  Źródło światła Light source |  Strumień świetlny Luminous flux |  Temperatura barwowa Color temperature |  Materiał Material |  szer./wys./gl. [mm] width x height x depth [mm] |
|--|---|--|--|--|--|--|--|
| OR-OM-6120L4 | 5900378655794 | 5 W | LED SMD | 320 lm | 4000 K | Tworzywo sztuczne Plastic | 300 / 105 / 42 |
| OR-OM-6104L4 | 5902560329933 | 5 W | LED SMD | 300 lm | 4000 K | Aluminium Aluminium | 300 / 100 / 40 |
| OR-OM-6121L4 | 5900378658153 | 6 W | LED SMD | 540 lm | 4000 K | Tworzywo sztuczne+akryl Plastic+acrylic | 400 / 105 / 42 |
| OR-OM-6122L4 | 5900378658160 | 9 W | LED SMD | 810 lm | 4000 K | Tworzywo sztuczne+akryl Plastic+acrylic | 600 / 105 / 42 |
| OR-OM-6123L4 | 5900378658177 | 6 W | LED SMD | 510 lm | 4000 K | Aluminium+akryl Aluminium+acrylic | 400 / 100 / 35 |



Sterowanie oświetleniem

Automation for lighting control

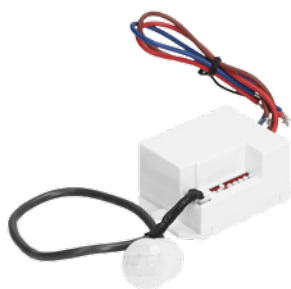

Model: OR-CR-211
EAN: 5901752481534



Czujnik ruchu 360° z zewnętrznym sensorem,
IP20, 800W

PIR motion sensor 360° with external probe, IP20, 800W

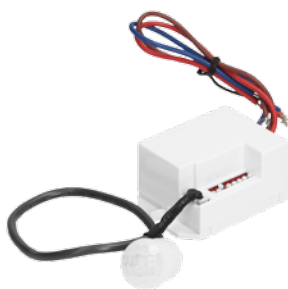

Model: OR-CR-211/12-24V
EAN: 5902560327540



Czujnik ruchu 360° z zewnętrznym sensorem,
IP20, 12-24V, 60W-120W

PIR motion sensor 360° with external probe,
IP20, 12-24V, 60W-120W



Model: OR-CR-213
EAN: 5901752482548



Włącznik bezdotkowy dwubiegunowy,
IP20, 800W

Non-contact two way switch, IP20, 800W



Model: OR-CR-244
EAN: 5901752485266



Włącznik bezdotkowy, jednobiegunowy,
IP20, 250W

Non-contact one way switch IP20, 250W



Model: OR-CR-245
EAN: 5901752485273



Włącznik dotykowy, IP20, 500W
Touch switch, IP20, 500W



Model: OR-CR-227
EAN: 5901752483088



Czujnik zmierzchowy z zewnętrzną sondą,
IP54, mini, 2000W

Mini twilight sensor with external probe, IP54







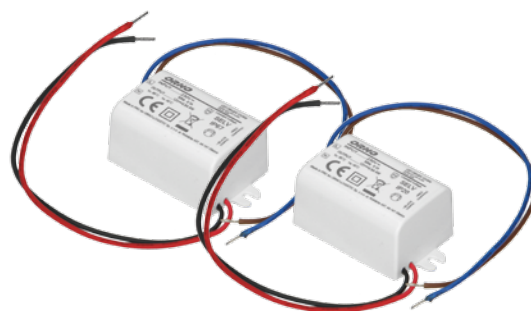



Zasilacze LED

LED power supplies



OR-ZL-1650
OR-ZL-1651
OR-ZL-1652

OR-ZL-1629
OR-ZL-1630

|  Symbol Product no |  EAN |  Napięcie wyjścia Output voltage |  Prąd wyjścia Output current |  Moc Rated power |  Napięcie wejścia Input voltage |  Stopień ochrony Protection rating |  Wysokość [mm] Height [mm] |  szer./wys./gl. [mm] width x height x depth [mm] |
|--|---|--|--|--|---|--|--|--|
| OR-ZL-1650 | 5908254803918 | 12V DC | 1,25 A | 15 W | 230V~,50Hz | IP 20 | 16,5 | 103 / 35,5 / 16,5 |
| OR-ZL-1651 | 5908254803925 | 12V DC | 2,5 A | 30 W | 230V~,50Hz | IP 20 | 18 | 160 / 58 / 18 |
| OR-ZL-1652 | 5908254803932 | 12V DC | 5 A | 50 W | 230V~,50Hz | IP 20 | 18 | 160 / 58 / 18 |
| OR-ZL-1629 | 5900378655428 | 12V DC | 0,5 A | 6 W | 230V~,50Hz | IP 20 | 22 | 55 / 29,5 / 22 |
| OR-ZL-1630 | 5900378655435 | 12V DC | 0,5 A | 6 W | 230V~,50Hz | IP 67 | 22 | 55 / 29,5 / 22 |

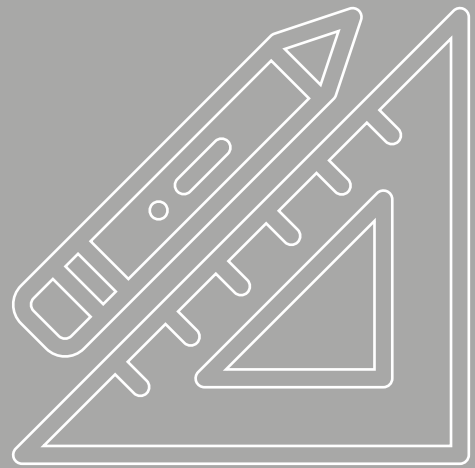

Rysunki techniczne

TECHNICAL DRAWINGS



Model:
 OR-AE-1335/G
 OR-AE-1335/B
 OR-AE-1338/G
 OR-AE-1338/B

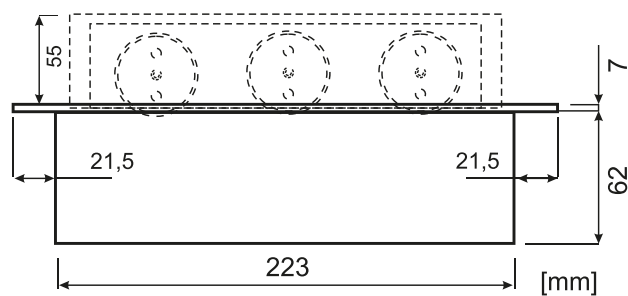
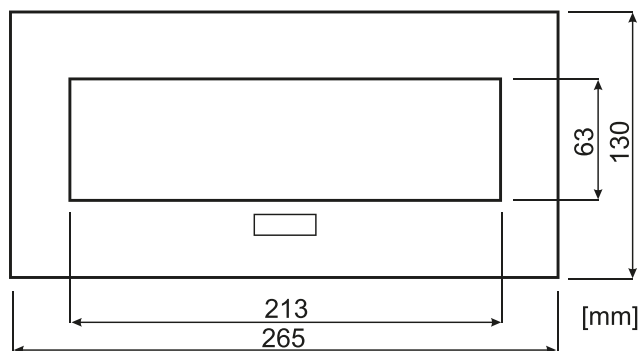
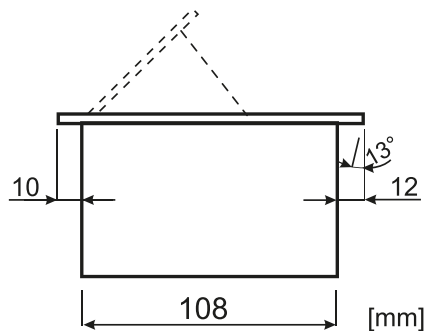

Model:
 OR-AE-1371/G
 OR-AE-1371/B
 OR-AE-1372/G
 OR-AE-1372/B

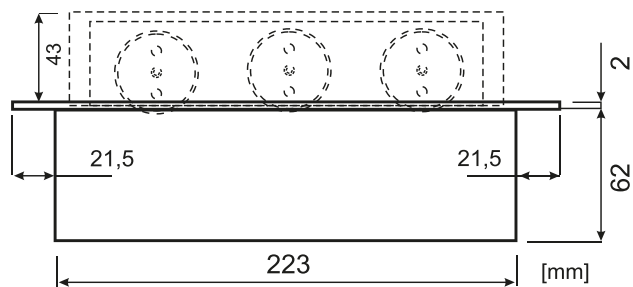
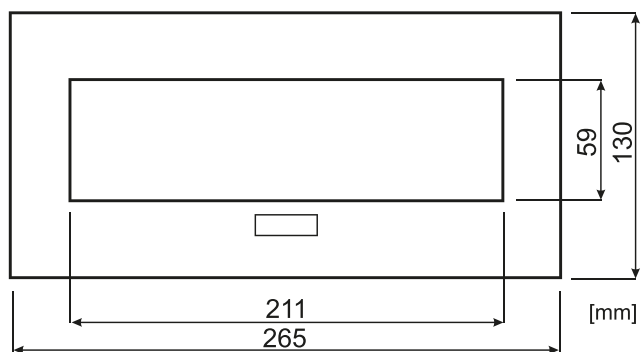
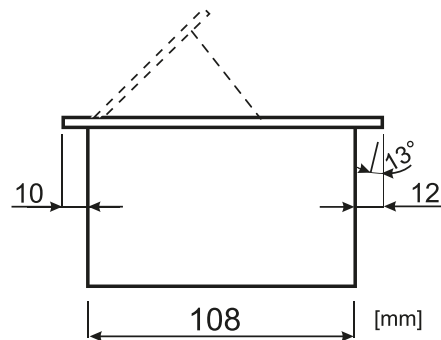



Model:

| | | | |
|------------------|------------------|------------------|---------------|
| OR-AE-1336/G | OR-AE-1336/BR | OR-AE-1337/B(GS) | OR-AE-13126/G |
| OR-AE-1336/G(GS) | OR-AE-1336/GR | OR-AE-1337/C | OR-AE-13126/B |
| OR-AE-1336/B | OR-AE-1337/G | OR-AE-1324/B | OR-AE-1337/BR |
| OR-AE-1336/B(GS) | OR-AE-1337/G(GS) | OR-AE-13109/G | OR-AE-1337/GR |
| OR-AE-1336/C | OR-AE-1337/B | OR-AE-13109/B | OR-AE-1324/G |

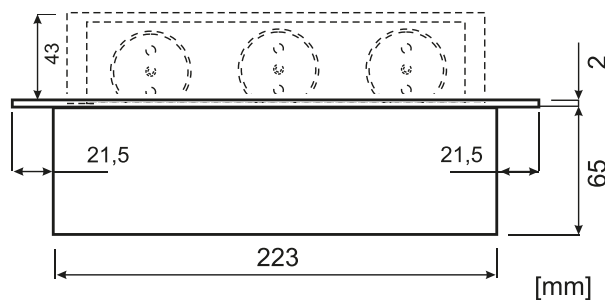
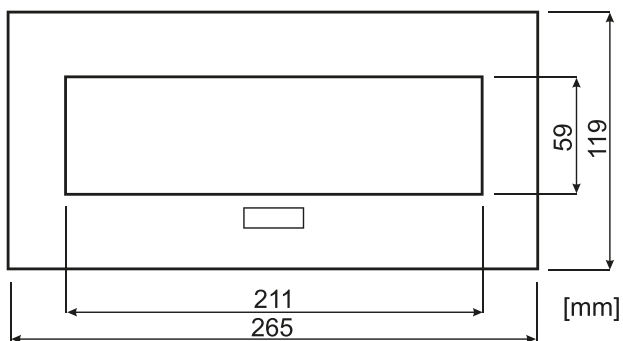
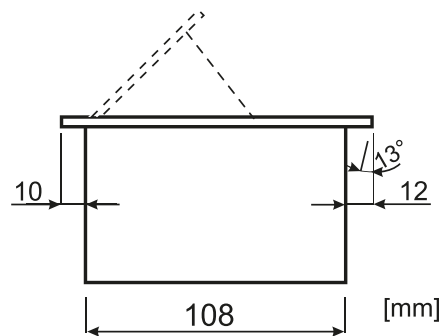

Model:

| |
|-------------------|
| OR-AE-13127(GS)/B |
| OR-AE-13125/B |
| OR-AE-13125/B(GS) |

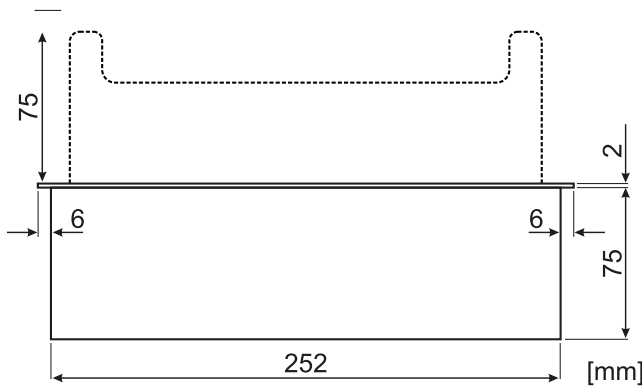
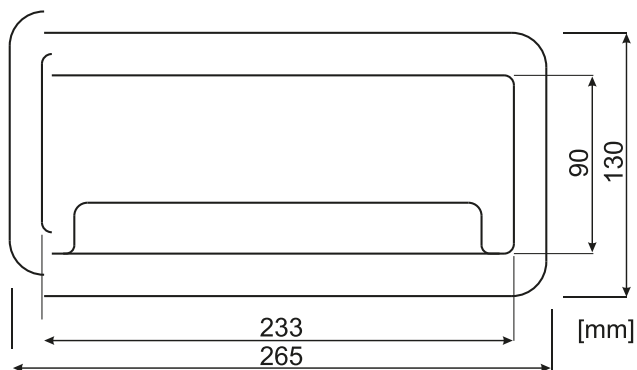
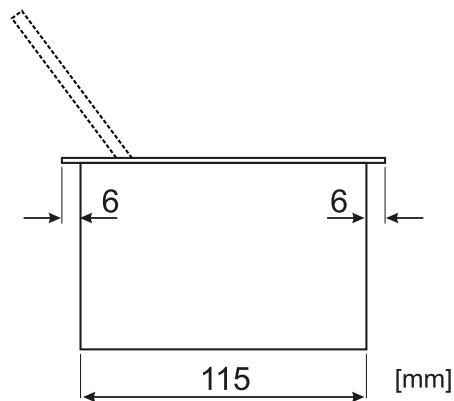



Model:
OR-AE-1361
OR-AE-1362

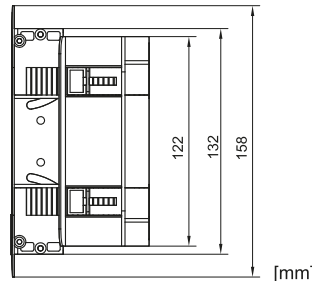
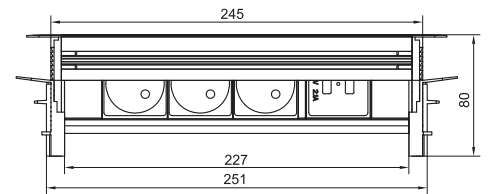
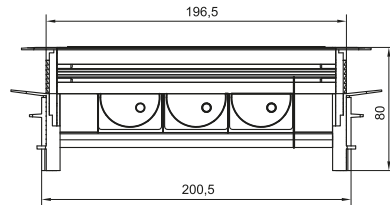
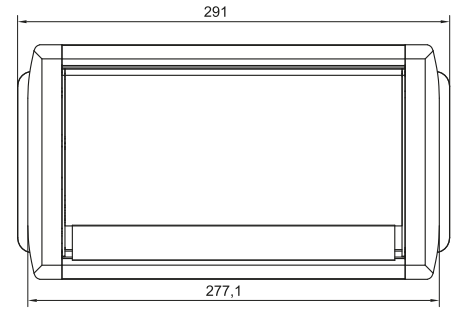
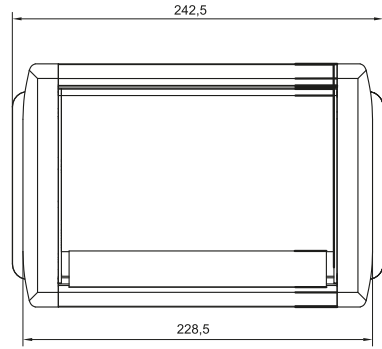

OR-AE-1361

[mm]

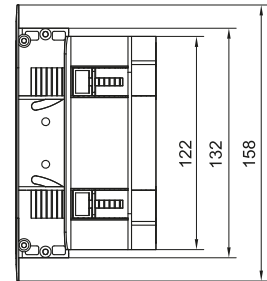

OR-AE-1362

[mm]

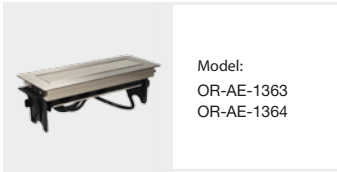

Model:
OR-AE-1363
OR-AE-1364

OR-AE-1363

OR-AE-1364

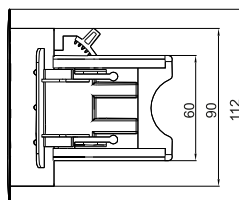
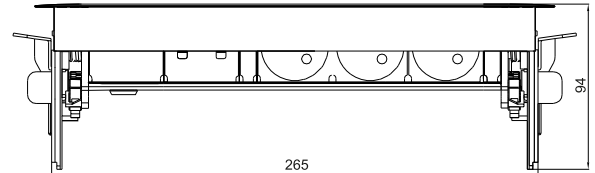
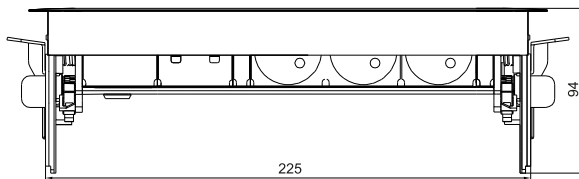
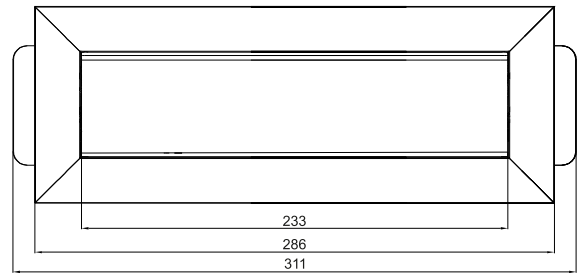
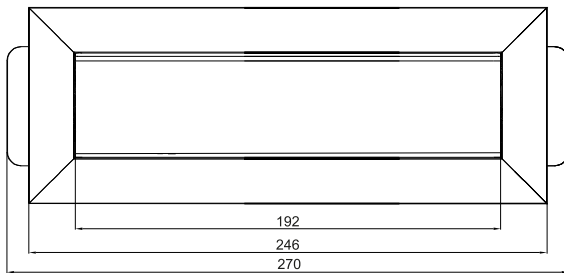

[mm]

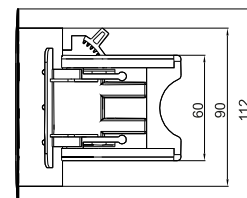

[mm]

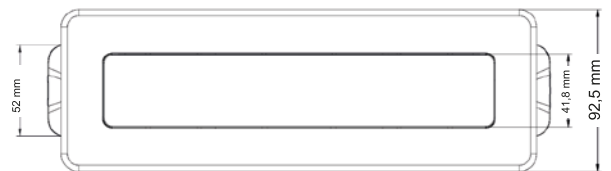
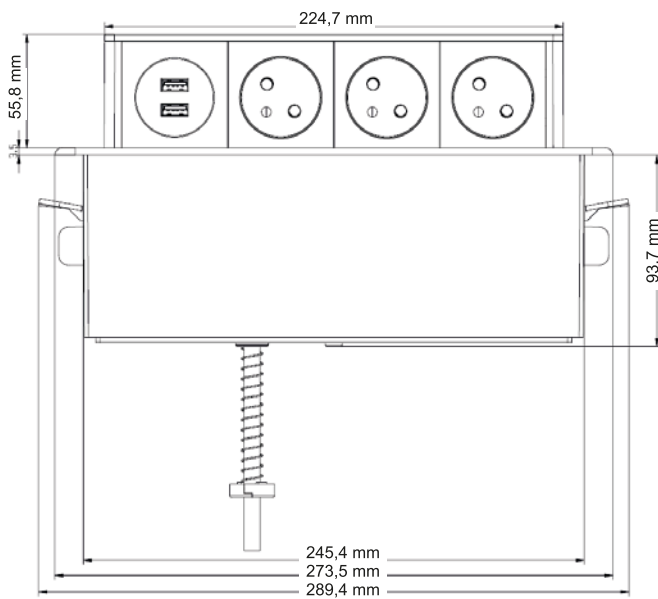
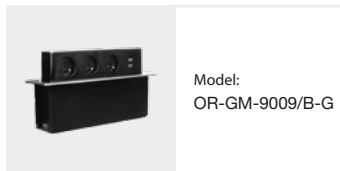
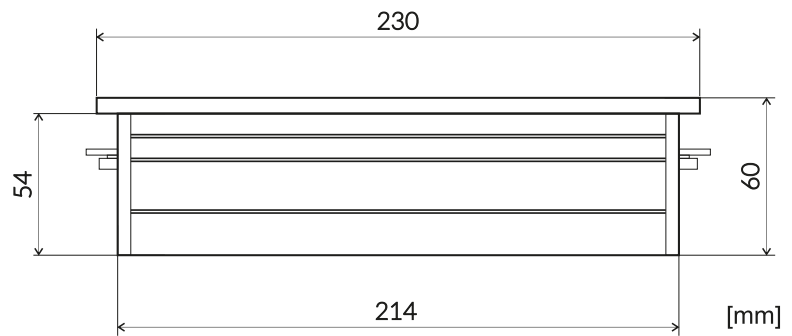
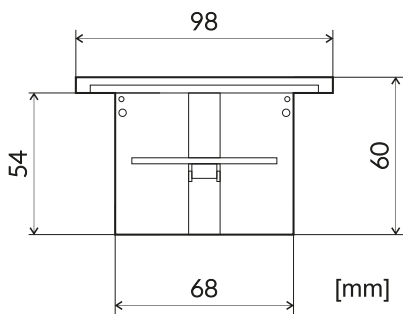



Model:
OR-AE-13110

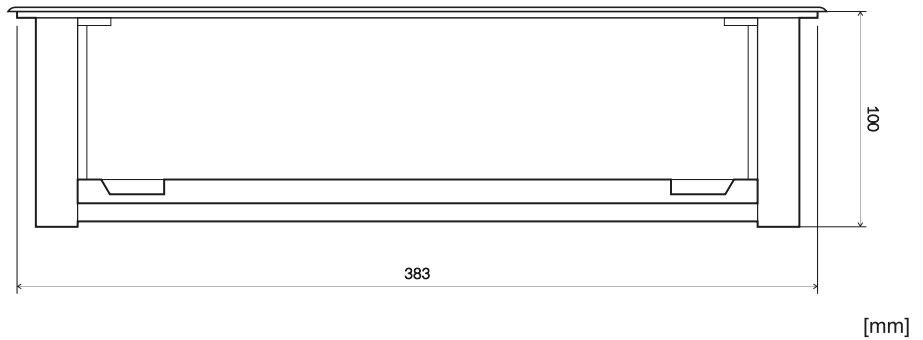
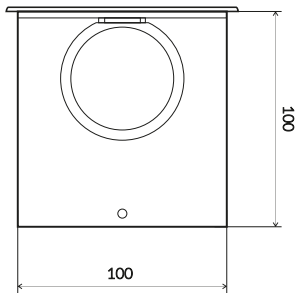
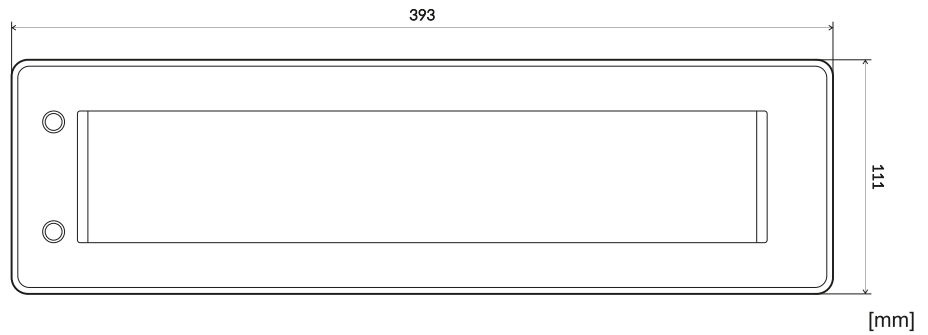

Model:
OR-GM-9010/W
OR-GM-9010/G
OR-GM-9010/B

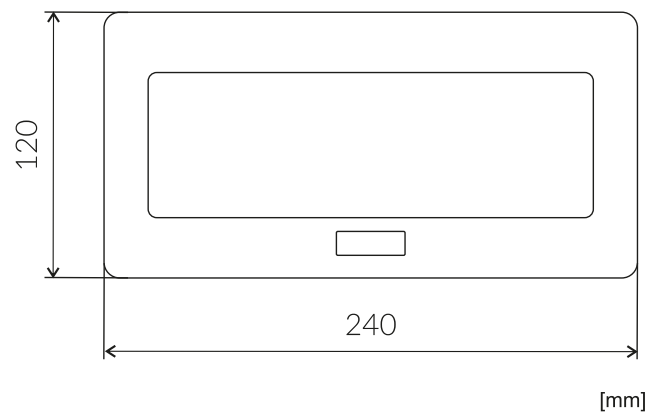
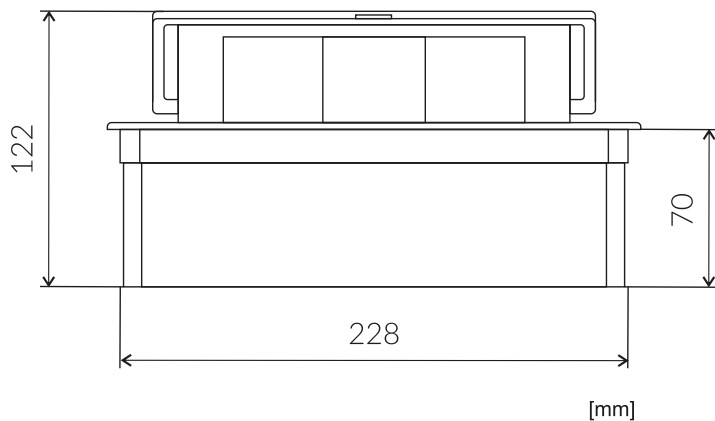
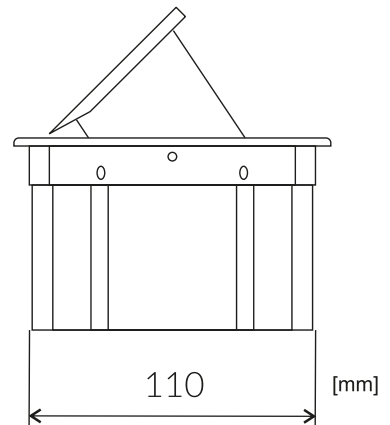



Model:
OR-AE-1347
OR-AE-1348

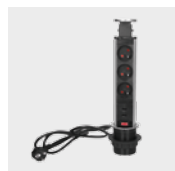
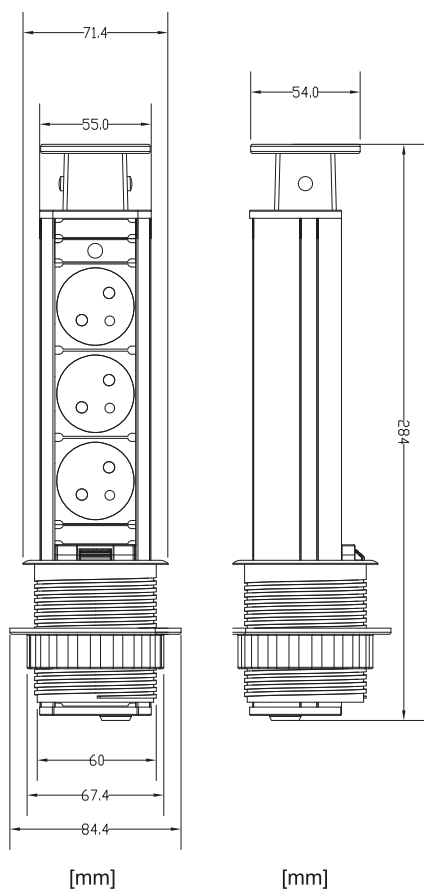

Model:
OR-AE-1349
OR-AE-1350

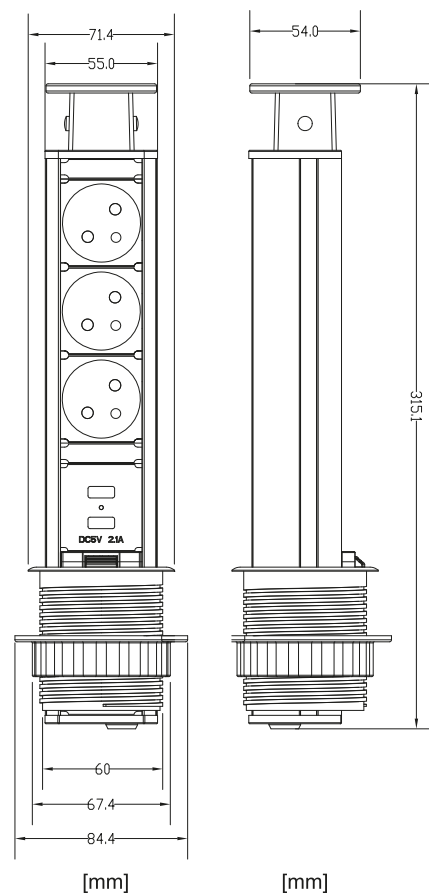

Model:
OR-AE-1355
OR-AE-1356

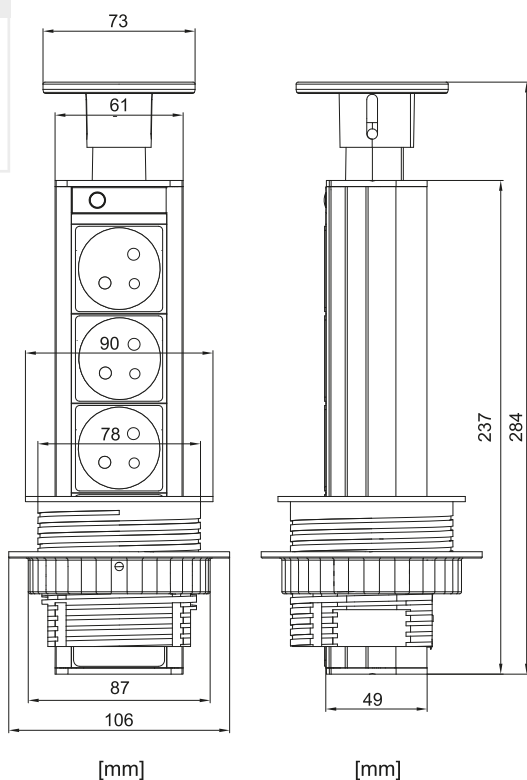

Model:
OR-AE-1357

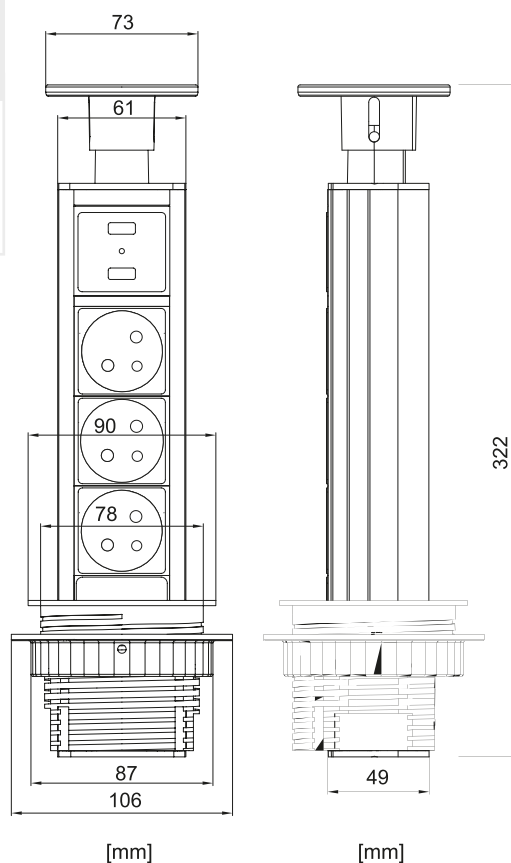



Model:
OR-AE-1351
OR-AE-1352

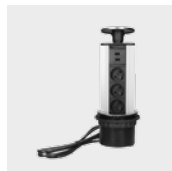
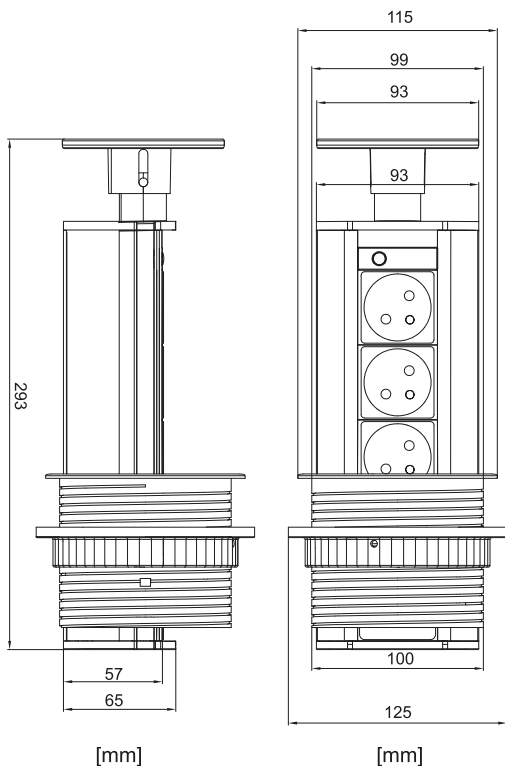

Model:
OR-AE-1353
OR-AE-1354

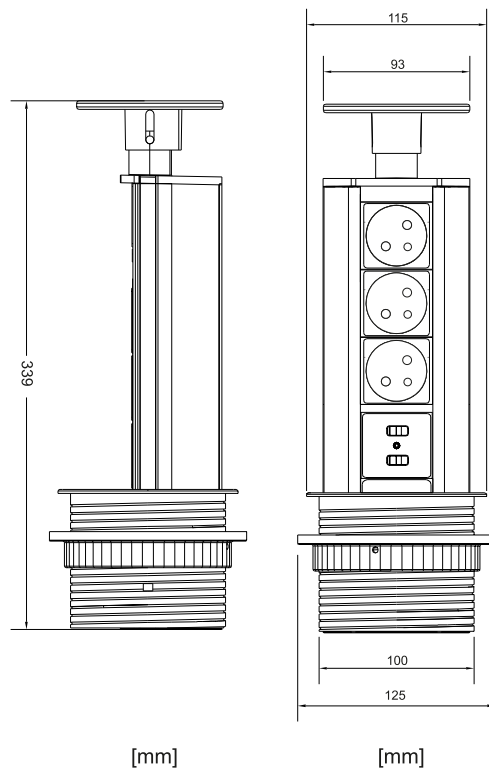

Model:
OR-AE-1341 OR-AE-1380
OR-AE-1341(GS) OR-AE-1381
OR-AE-1342 OR-AE-1381(GS)
OR-AE-1342(GS)

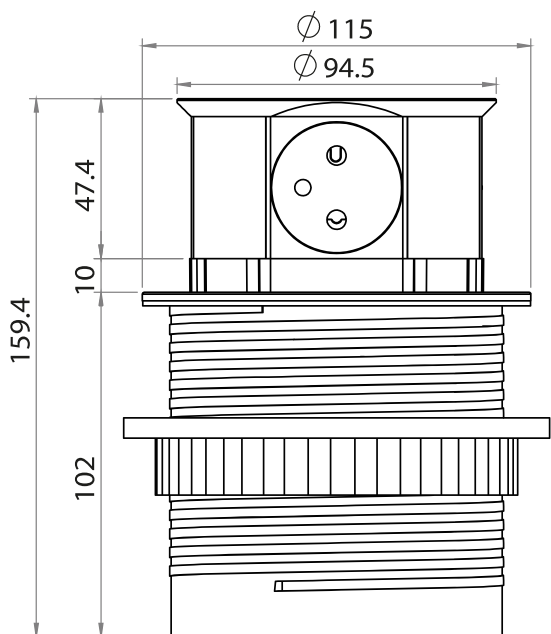

Model:
OR-AE-1397
OR-AE-1398

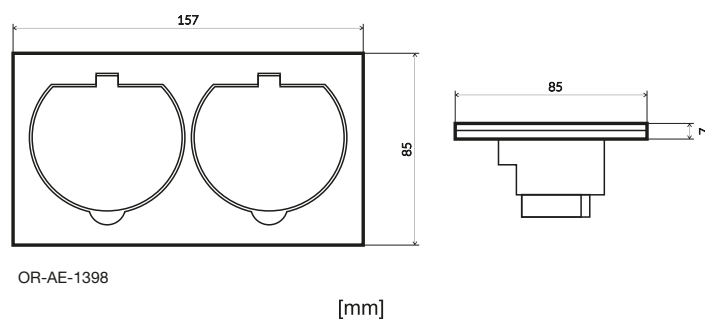
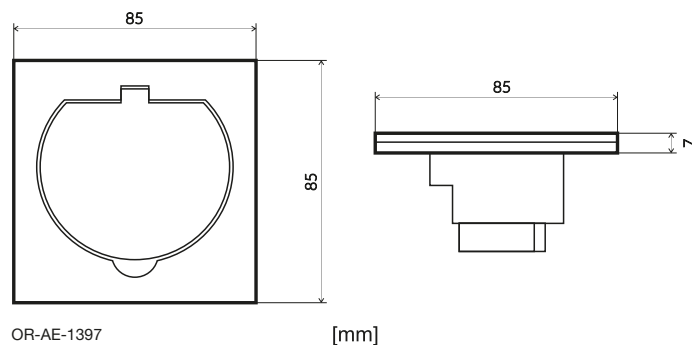

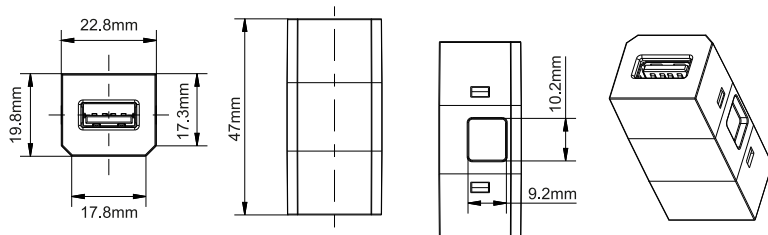
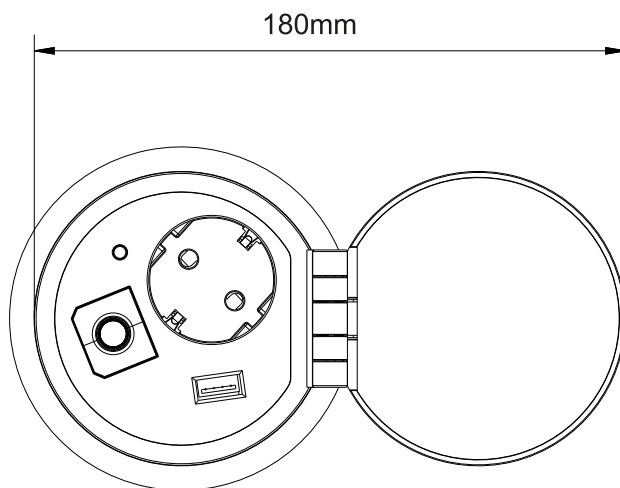
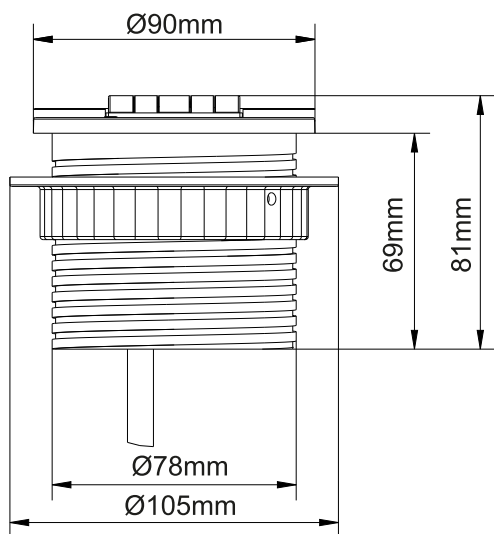
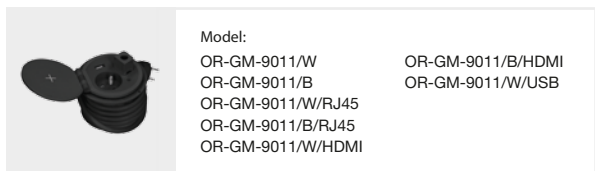
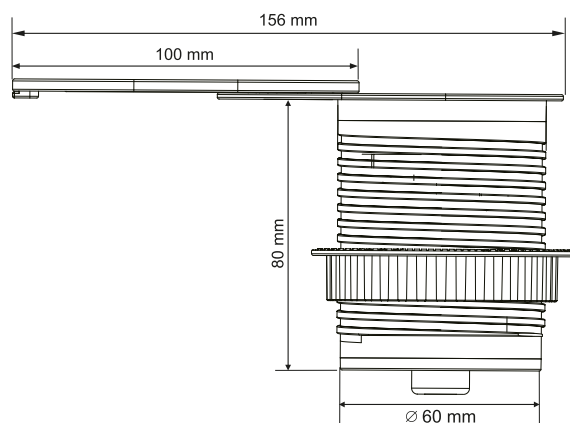
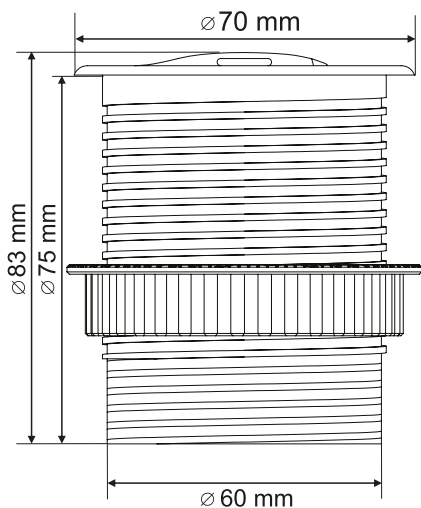
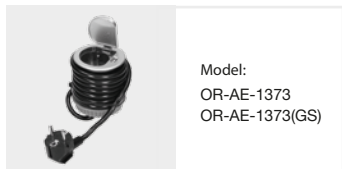

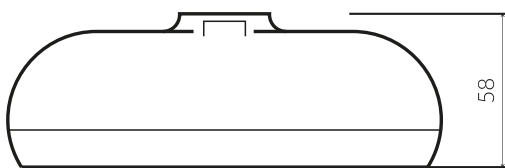
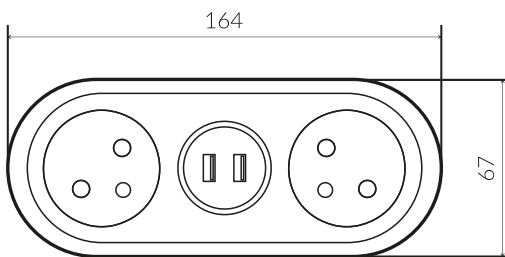
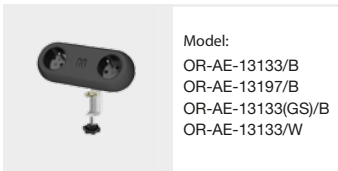
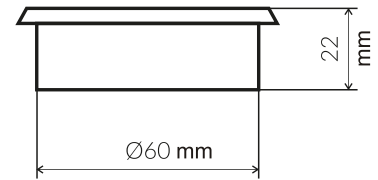
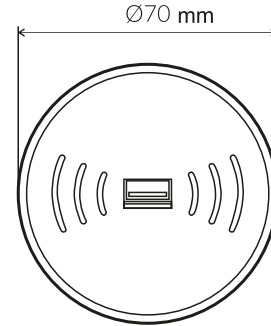
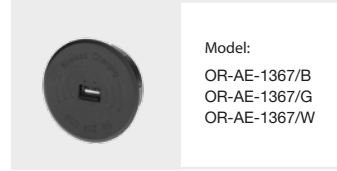
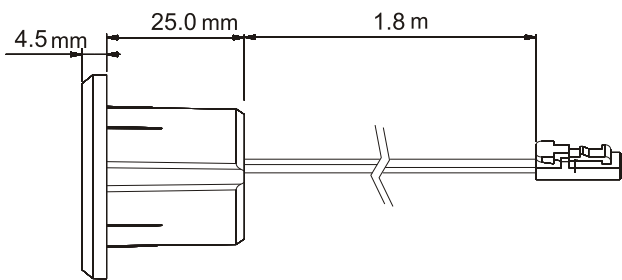
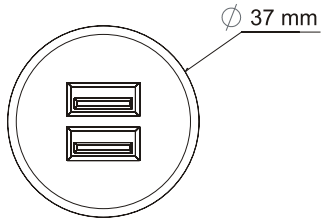

[mm]

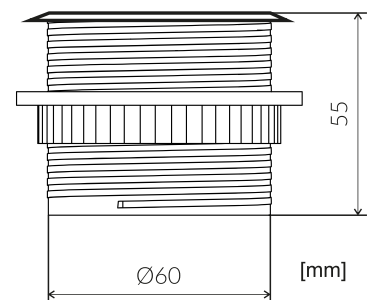
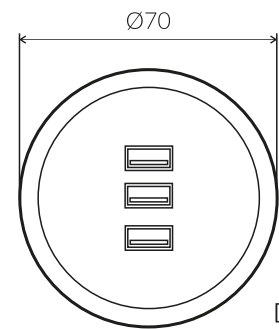
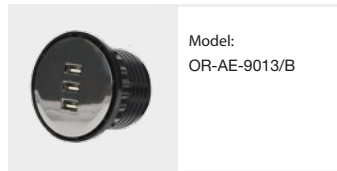

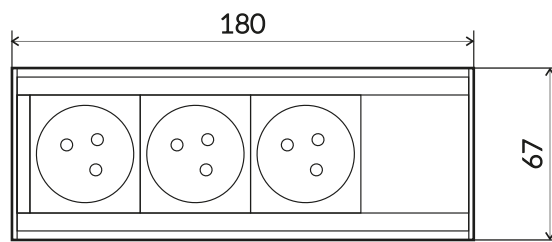
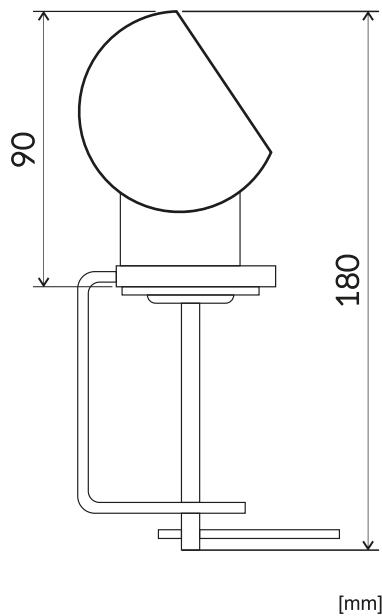

OR-AE-13100

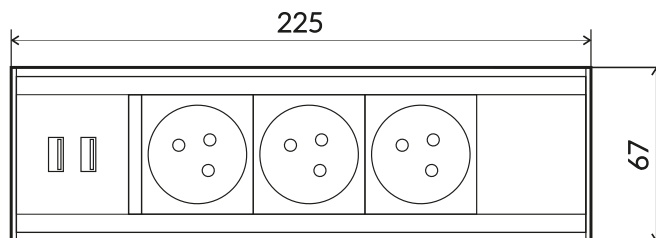

OR-AE-13101

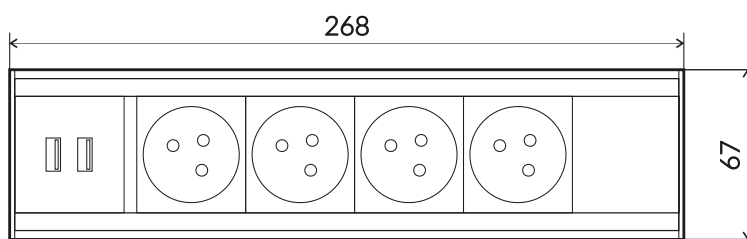

OR-AE-13103

[mm]

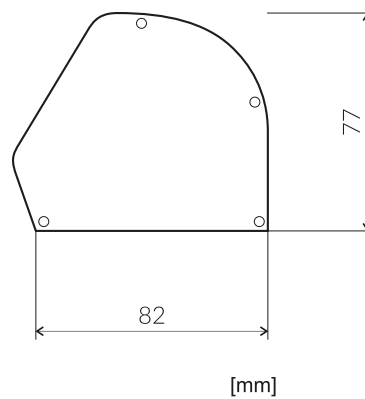
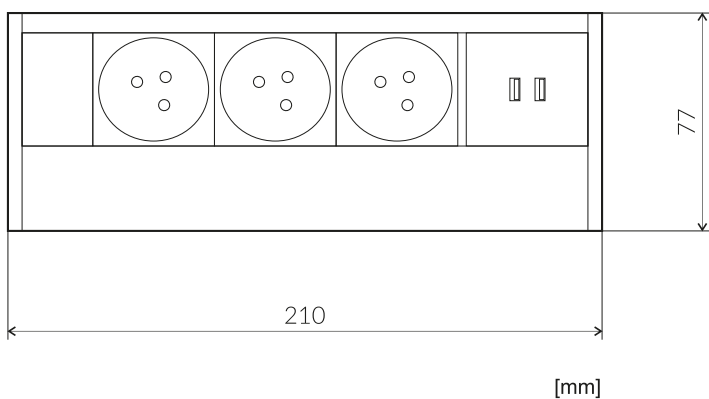
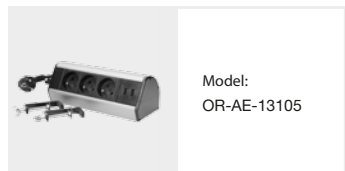

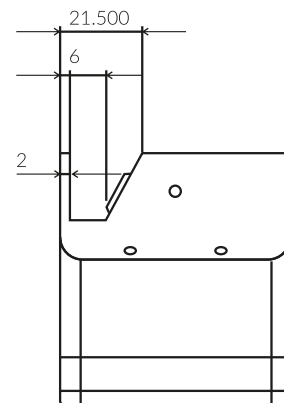
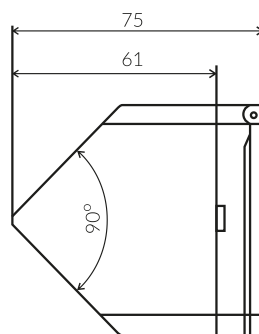
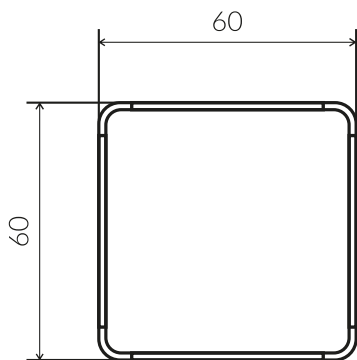
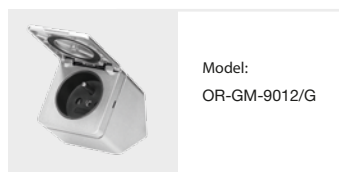
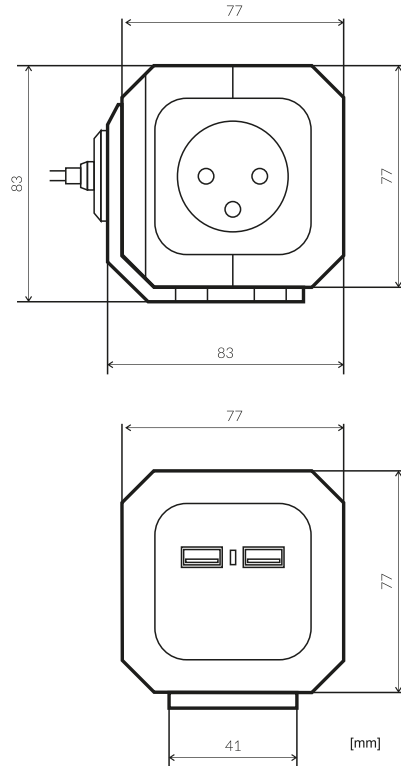
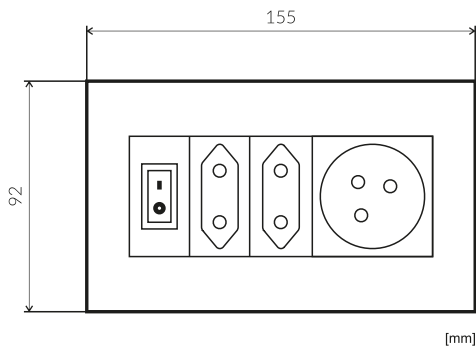
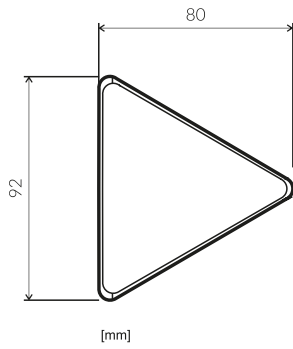

[mm]



Model:
OR-AE-1383

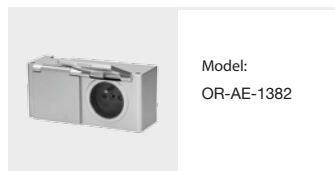
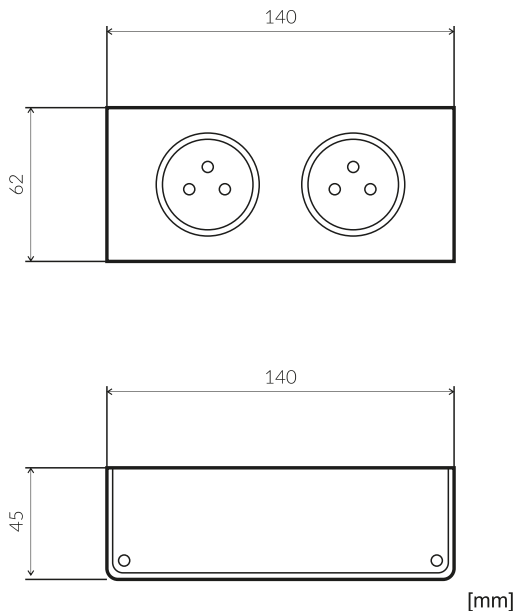

Model:
OR-AE-1382

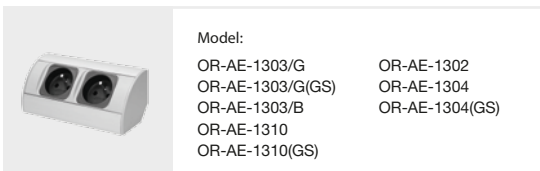
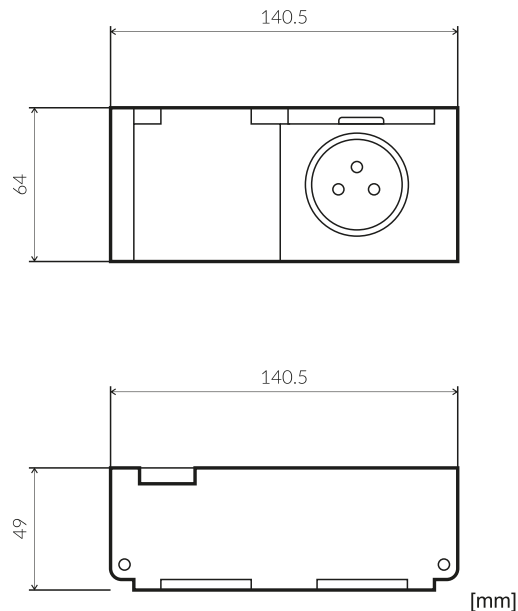

Model:
OR-AE-1303/G OR-AE-1302
OR-AE-1303/G(GS) OR-AE-1304
OR-AE-1303/B OR-AE-1304(GS)
OR-AE-1310
OR-AE-1310(GS)

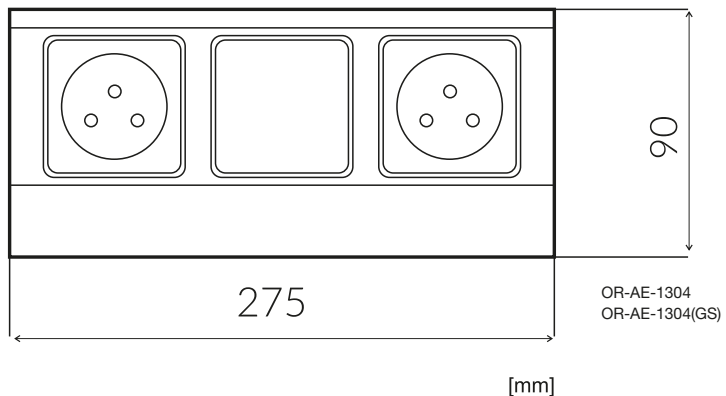
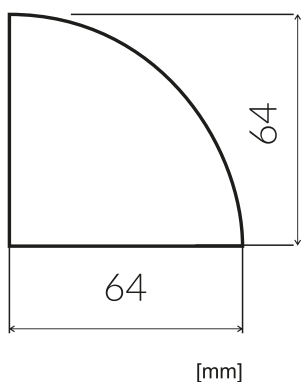
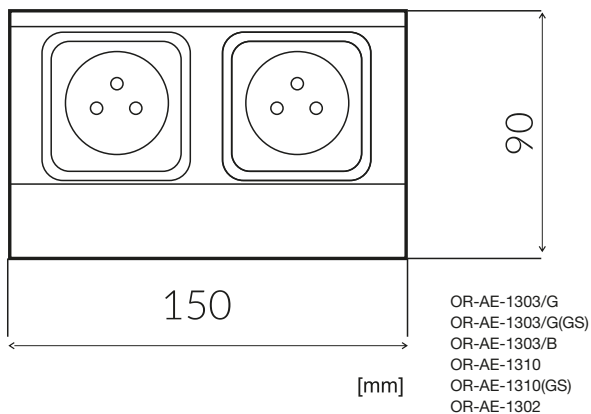



Model:

- | | | |
|--------------------|--------------------|--------------------|
| OR-GM-9005/W-G | OR-GM-9003/W-G(GS) | OR-GM-9002/W-G |
| OR-GM-9005/W-G(GS) | OR-GM-9001/B-G | OR-GM-9002/W-G(GS) |
| OR-GM-9001/W-G | OR-GM-9001/B-G(GS) | |
| OR-GM-9001/W-G(GS) | OR-GM-9002/B-G | |
| OR-GM-9003/W-G | OR-GM-9002/B-G(GS) | |

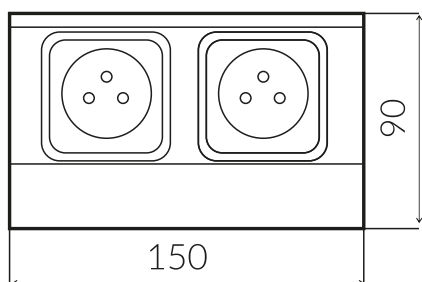
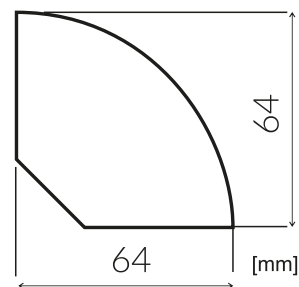

OR-GM-9005/W-G
OR-GM-9005/W-G(GS)

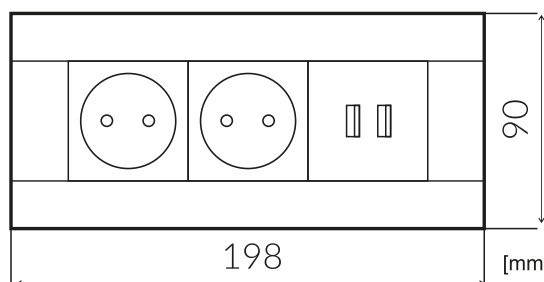

OR-GM-9003/W-G
OR-GM-9003/W-G(GS)

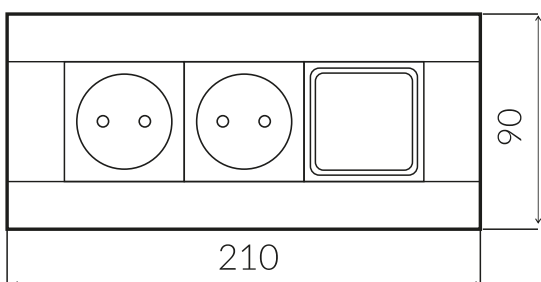

OR-GM-9002/B-G
OR-GM-9002/B-G(GS)
OR-GM-9002/W-G
OR-GM-9002/W-G(GS)

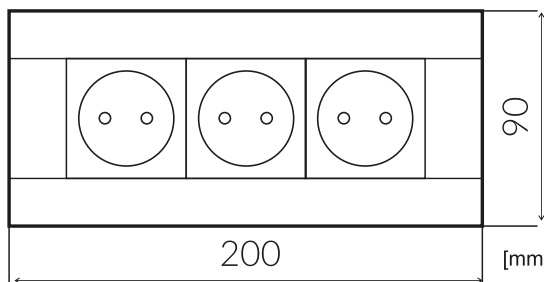

OR-GM-9001/W-G
OR-GM-9001/W-G(GS)
OR-GM-9001/B-G
OR-GM-9001/B-G(GS)



Model:

- OR-AE-1340
OR-AE-1340(GS)

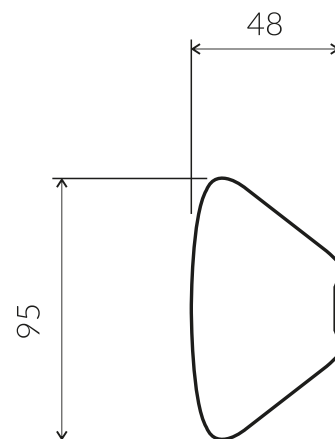
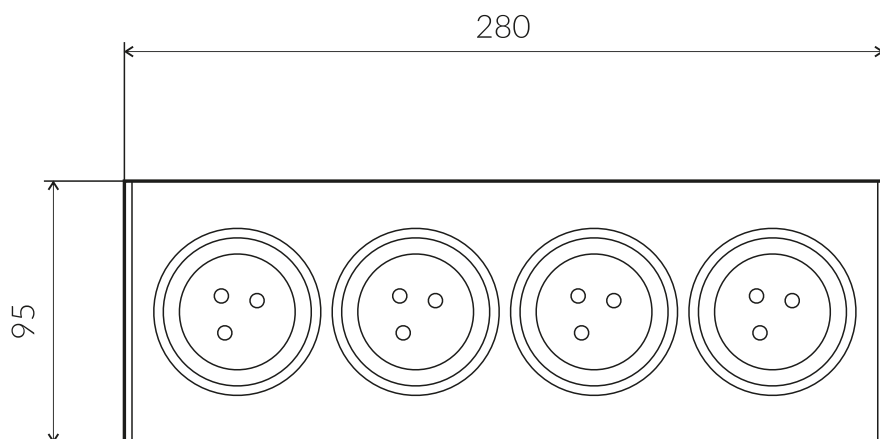

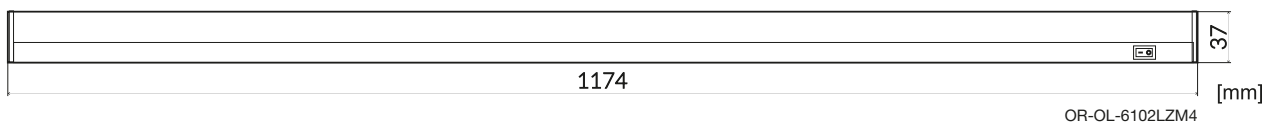
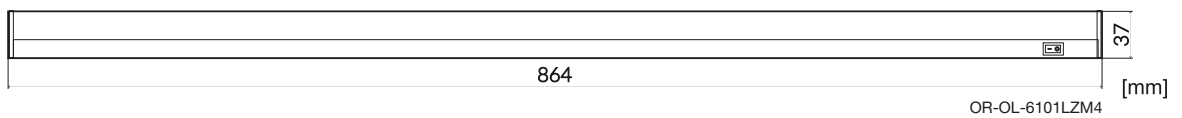
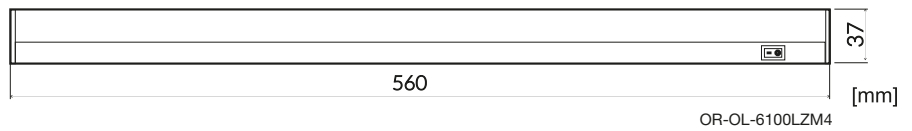
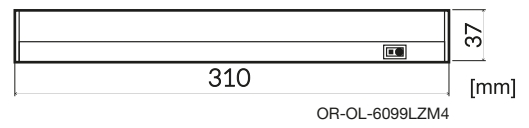
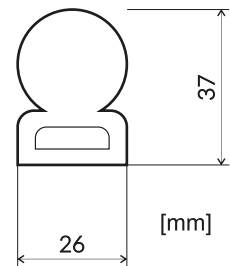
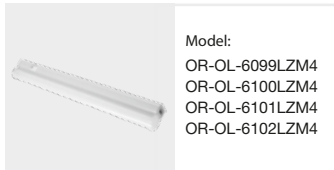
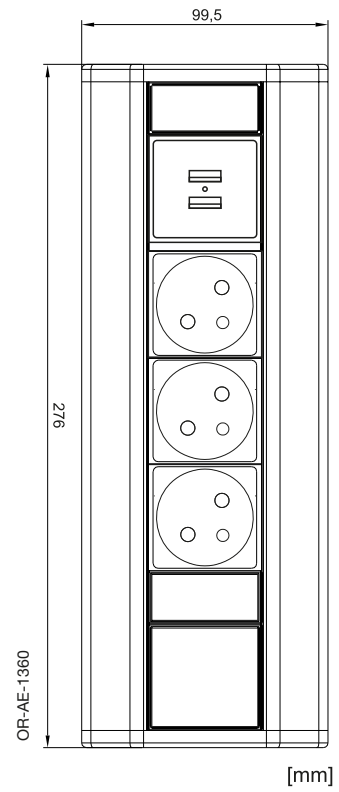
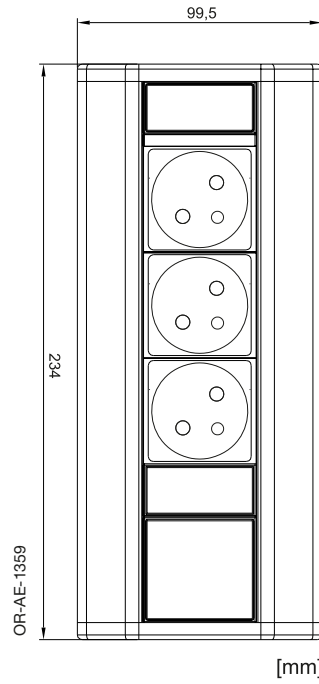
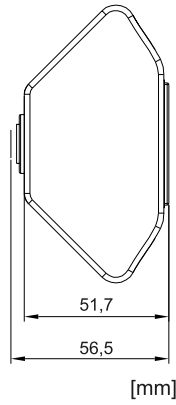

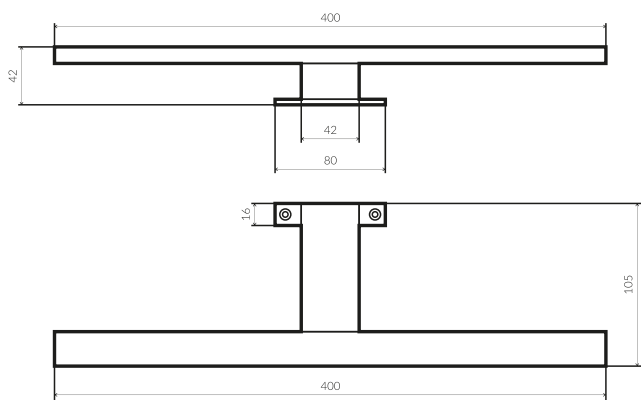
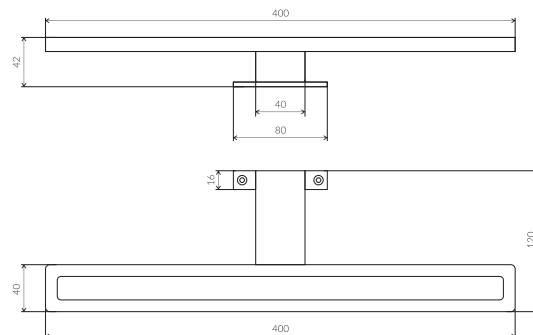
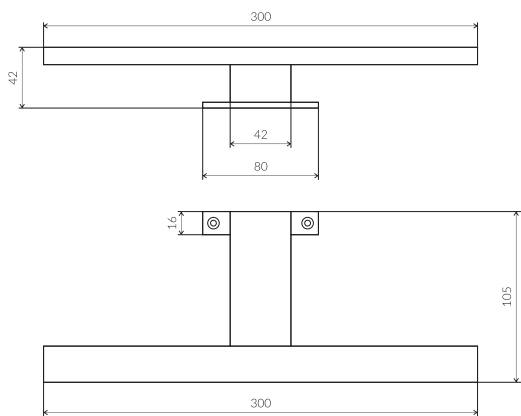

OR-OM-6121L4

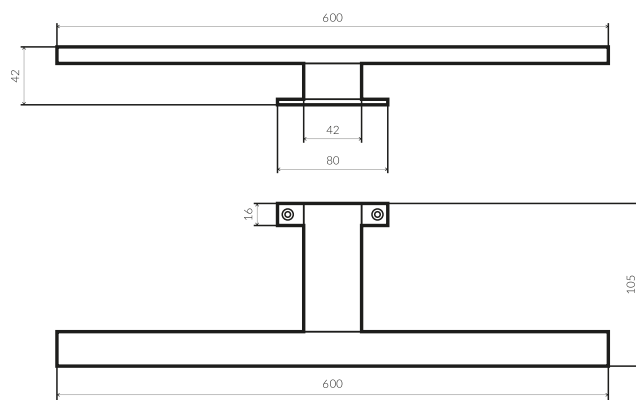

OR-OM-6122L4

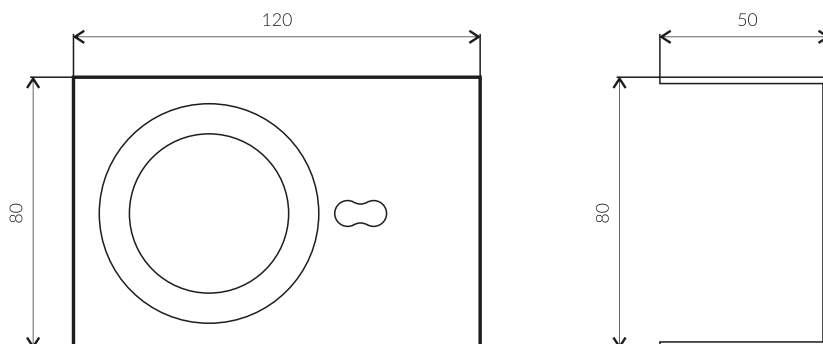
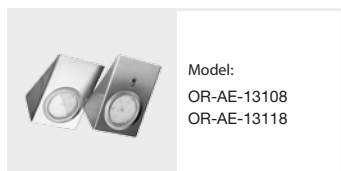

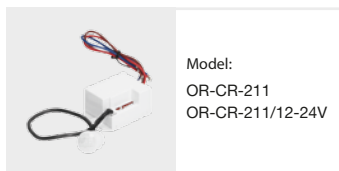

Model:
OR-CR-211
OR-CR-211/12-24V

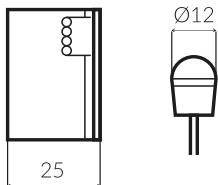
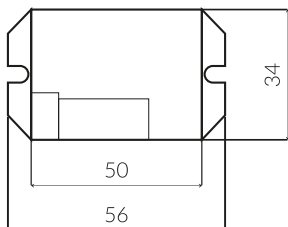

Model:
OR-CR-213
OR-CR-244

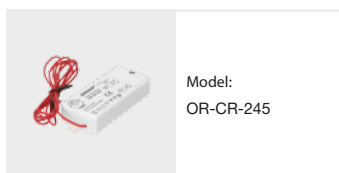
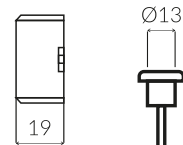
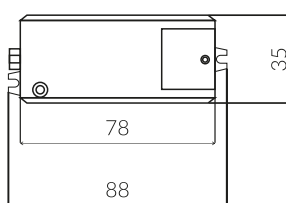

Model:
OR-CR-245

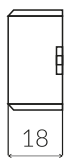
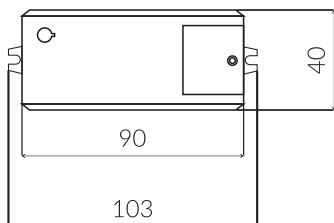

Model:
OR-CR-227

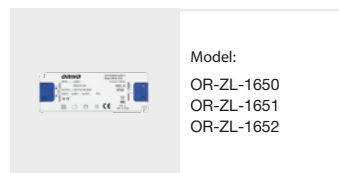
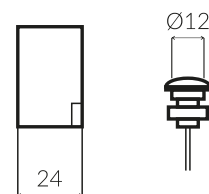
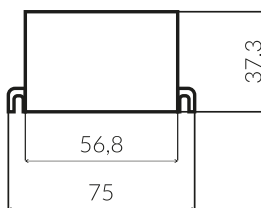

Model:
OR-ZL-1650
OR-ZL-1651
OR-ZL-1652

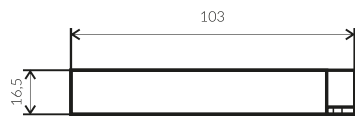
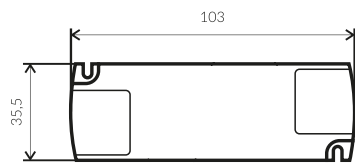

OR-ZL-1650

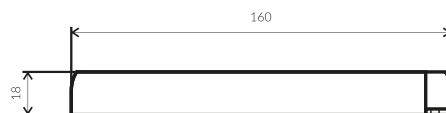
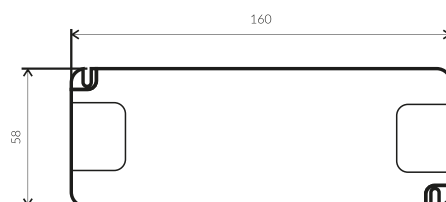

OR-ZL-1651
OR-ZL-1652

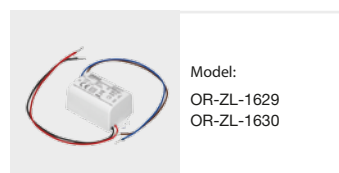

Model:
OR-ZL-1629
OR-ZL-1630

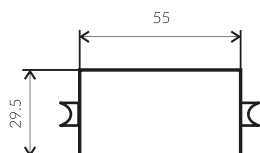

**Nie stoimy w miejscu.
Dzisiaj jesteśmy lepsi niż byliśmy wczoraj**
- i robimy wszystko
by jutro móc powiedzieć to samo...

**We never stand still.
Today we are better than we were yesterday**
- and we do everything
to be able to say the same thing tomorrow...

Rafał Owczarek
Prezes zarządu / President
ORNO-POLSKA Sp. z o.o.

