

xEffect - Industrial Switchgear Range



Catalogue 2016



Powering Business Worldwide

Eaton Online Catalog – find product details quickly and efficiently!

You can find comprehensive up-to-date product information at <http://ecat.moeller.net>

Lookup

You can search by keywords, product names, article numbers, technical data: The search understands everything and takes you straight to the product you're looking for.

Graphical navigation

Graphical representation of the fields of application and product groups.

Selection aids

Tailored to the typical expert's approach, this search aid helps you quickly find the product you need.

Data sheets

For every article the catalog can generate a technical data sheet, which you can convert to a PDF file for printing or saving with a single click.

Parts lists

From your search results you can create a parts list that you can then send to your Eaton sales partner as a query.



HTML data sheet; can be saved as PDF file.

Parts list

Item	Qty.	Photo	Article no.	Part no.	Short Text
<input type="checkbox"/>	1		111817	ES4P-221-DMND1	Safety control relay, 24 V DC trans.
<input type="checkbox"/>	1		229758	FAK-COMBINATION-*	Complete unit
<input type="checkbox"/>	1		284831	M22S-DDM-M-GR-X1100	Double act., illum., flat, off-button ext.
<input type="checkbox"/>	1		290090	DLM15-01 (110V/50HZ, 120V/50HZ)	Contactors, 7,5kW/400V, AC-operated
<input type="checkbox"/>	1		138516	PKER65XTU1-65	PKER65 + trip block Standard 8-65A

Select all

Delete position Save changes Add free position

next

Parts list, e.g. for queries to Eaton Sales.

You can find comprehensive up-to-date information about Eaton's automation products and switchgear in our Online Catalog.



MCBs and RCCBs for North American market UL certified for eOEMs who acting worldwide providing power distribution systems for Power Plants in North America.

High frequency TL lighting is often used in agricultural industry applications (such as barns). Conventional circuit breakers appear to sometimes fail spontaneously, which is very undesirable in barns. Consider a failure of the ventilation systems, feeding systems, manure and egg collection in poultry barns. By using the new digital circuit breaker from Eaton, the problem of undesired switch off can be minimized.



Solar



Agrar



B+ type RCCB for enhanced fire protection and where DC leakage currents occur – data centers,

High safety relevant applications e.g. hospitals where digital RCCBs are used in the distribution system,



Data center



Hospitals



Digital protection switches – the new era has begun.

Better security with proactive communication!

The digital RCCB from Eaton’s xEffect series are capable to do more than just switch off: They monitor electrical installations and issue advance warnings of critical current flows. Thanks to short time delay and optimized tripping threshold, briefly occurring malfunctions do not induce the digital protection switch to shut down.

When a fault current crops up, the information is reported to the security center of the industrial plant right away and troubleshooting can start before a plant failure occurs. Thus the cause of the fault current can be determined precisely and the system can be serviced easily.

That way, system availability increases and service is crucially improved by the convenient remote control.

Numerous advantages at a glance

- The difference between harmless and critical fault currents is detected
- Precise switching and reduction of nuisance tripping
- Continuous monitoring of plant/factory status – prompt warning of a change in status quo
- Convenient troubleshooting by precise location of the malfunction
- As easy to install as a conventional RCCB
- Longer intervals between servicing
- Ideal for system monitoring thanks to preventive information
- Warning of tripping at leakage current
- Clear status display of the fault current problem with tri-colored LEDs
- Real contact position indicator
- Indicator for fault current tripping
- Comprehensive range of accessories available
- Can be integrated in several bus systems

Highly qualified controllers offer their services

PROMOTION

Allow us to introduce ourselves: **FRCdM** and **FRBdM** would like to work in your switchbox. We're two highly qualified control robots from the famous EATON talent factory – the first of the new digital generation.

It's not only that I work completely reliably as a Residual Current Operated Circuit Breaker with integrated Overcurrent Protection (RCBO), but I also display the cause and extent of the flowing fault current.

This enables fast actions quickly take measures to maintain system availability.

And since I'm the RCCB a fault current protection switch, I don't wait until the tripping threshold is reached; I continuously check the present status and register any possible failures, sending this information by remote warning immediately to the central control system. This increases system safety, application availability and minimizes maintenance costs.

Hire us – and finally experience communication at eye level!

The LEDs set off an alarm when fault currents or a shut down are coming. This makes the troubleshooting faster and much easier. The service mode of the fault current protection switch quickly indicates the extent of the flowing fault current in milliamp increments. By pushing the service button, the blinking LED identifies the area where the fault current is located in.

- Mains voltage-independent residual current protection and additional protection with other digital functions
- Auto-reclosure is possible



Red

When the red LED lights up, the leakage current is already higher than 50 percent of the nominal fault current. Therefore the system is in a critical status – the digital RCCB only trips when the fault current continues to increase.

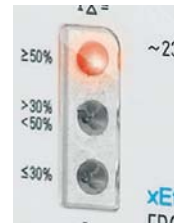

Yellow

The yellow LED shows a residual current in the ambit of 30 to 50 percent of the nominal fault current. Before the system is shut down, professional countermeasures can be taken.



Green

If the current flow in the system to ground is in the ambit from 0 to 30 percent of the nominal fault current, the green LED indicates the proper status.



FRBdM and FRCdM offer several other advantages



The LED allows for a fault current display directly on site. In the service mode, malfunction causes can be determined quickly and without complication.

Digital Combi-switch FRBdM:

With help of the service mode, the exact extent of the leakage current can be identified. This is a big advantage for industrial plants and any locations where the maximum security of supply must be ensured in time before the shut down of the plant.



The digital display facilitates real-time diagnostics directly at the switch. By means of the LEDs, the system status can be seen at anytime, and with one glance.

All models have at least a short time delay to prevent from nuisance tripping due to transient disruptions (lightning, engine start).

Digital RCCB type A

Protection in case of specific, non-smooth types of DC fault currents.

Digital RCCB type B

In addition to fault currents in the AC and pulse current range, type B also detects DC fault currents, which can occur in frequency inverter controls, photovoltaic systems as well as through the electronic use in households, and increases safety considerably.

Digital RCCB type B+

Complies with the standard VDE 0664-400 (formerly VVDEV 0664-110) for elevated fire protection as required by the Association of German Insurance Companies.

Digital RCCB type Bfq

Adjusted frequency range (insensitive to higher frequencies) prevents nuisance tripping errors in industrial plants with powerful frequency inverter controllers.

xEffect - All residual current sensitive RCCB



- Safe power disconnection at smooth DC and AC
- Residual Currents
- Highest system availability by digital technology
- Real-time measurement of the residual current
- Easy operation and refitting
- Yearly test intervall

Digital Residual Current Circuit Breaker Typ B

The RCCB Typ B detects (acc. to IEC 62423) beside AC and pulsating DC residual currents also smooth DC residual currents. Smooth DC residual currents can occur in industrial, commercial and residential applications which contain photovoltaic systems, frequency converters or electronic consumers. The extended sensitivity of the RCCB Typ B increase safety considerably.

Digital Residual Current Circuit Breaker Typ B+

The RCCB Typ B+ is sensitive to all residual currents and is additionally equipped with a tripping curve which limits the tripping current to max. 420mA for frequencies up to 20kHz. This comply additionally the specifications for the superior fire protection according to the German standard VDE 066-440 (formerly VVDEV 0664-110).

Digital Residual Current Circuit Breaker Typ Bfq

The special adapted tripping curve (non-sensitive against system caused earth leakage currents at high frequencies) of the RCCB Typ Bfq comply the specifications of the RCCB Typ B and avoid in addition unwanted tripping in industrial applications which contains high-power frequency converter controls!

Applications:

The digital RCCBs Typ B, B+ or Bfq apply in all systems, machines or devices in which DC residual currents can occur as:

- DC applications as photovoltaic or UPS units
- Medical devices as x-ray apparatus
- Test and experimental equipment in laboratories and training rooms
- Frequency converter for motor applications
- Controls for elevators and cranes
- Charging stations for electro vehicles (e.g. forklift)
- Speed regulated machine tools as millers, turning machines, grinders ...
- Garages (e.g. use of welding apparatus)
- Construction areas
- E-Car charging stations

Lean connectivity for protective devices (MCBs, RCCBs, RCBOs)



- Permanent information of the system
- Decrease system downtime/Increase system uptime
- Direct connection to the SmartWire-DT line
- Reduction of installation time, wiring and costs

The SmartWire-DT MCB module allows a fast and easy connection of protective devices as MCBs, RCCBs and RCBOs to the SmartWire-DT line.

This gives machinery builders and installers the possibility to integrate protective devices comfortably in the Lean automation.

The status (on, off, tripped) of the protective devices is so implemented in the control or monitor system of the machinery or the power distribution and supports the service and maintenance teams permanently with information about the system and helps to react immediately in case of problems to keep the system downtime as short as possible.

A further big benefit is also the direct connection on the SmartWire-DT line. This makes the additional I/O level and wiring redundant and machinery builders can reduce so installation time and costs.



Example: Savings in every step of the life cycle

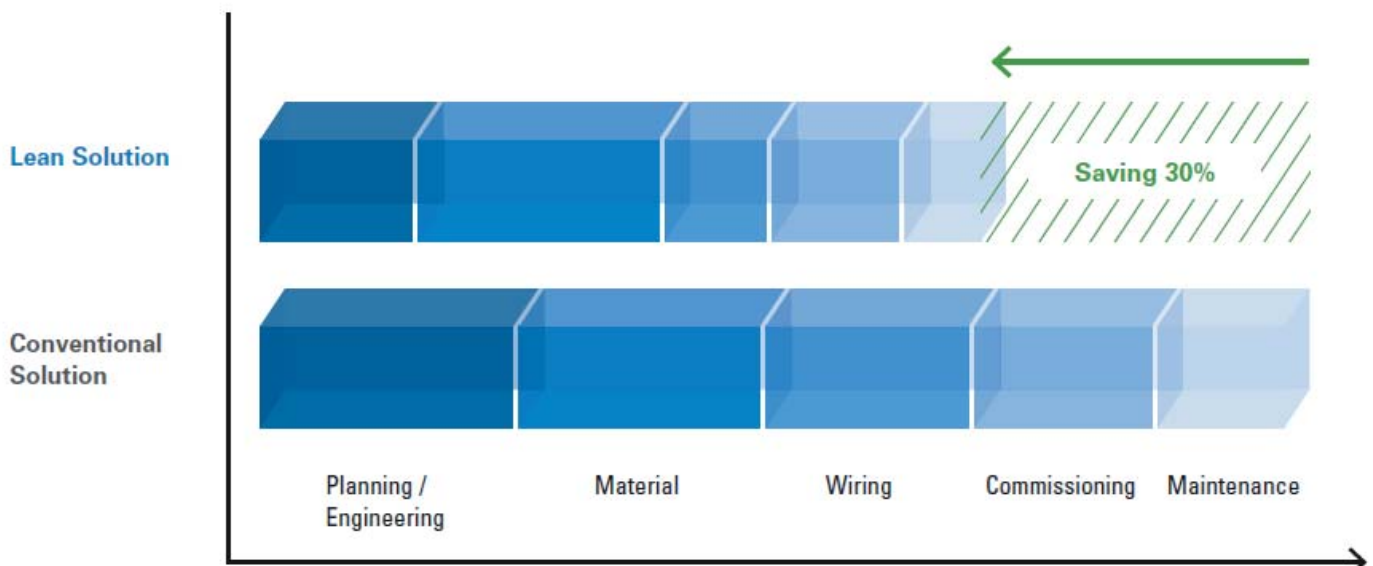

When do I use Typ B, Bfg and B+?

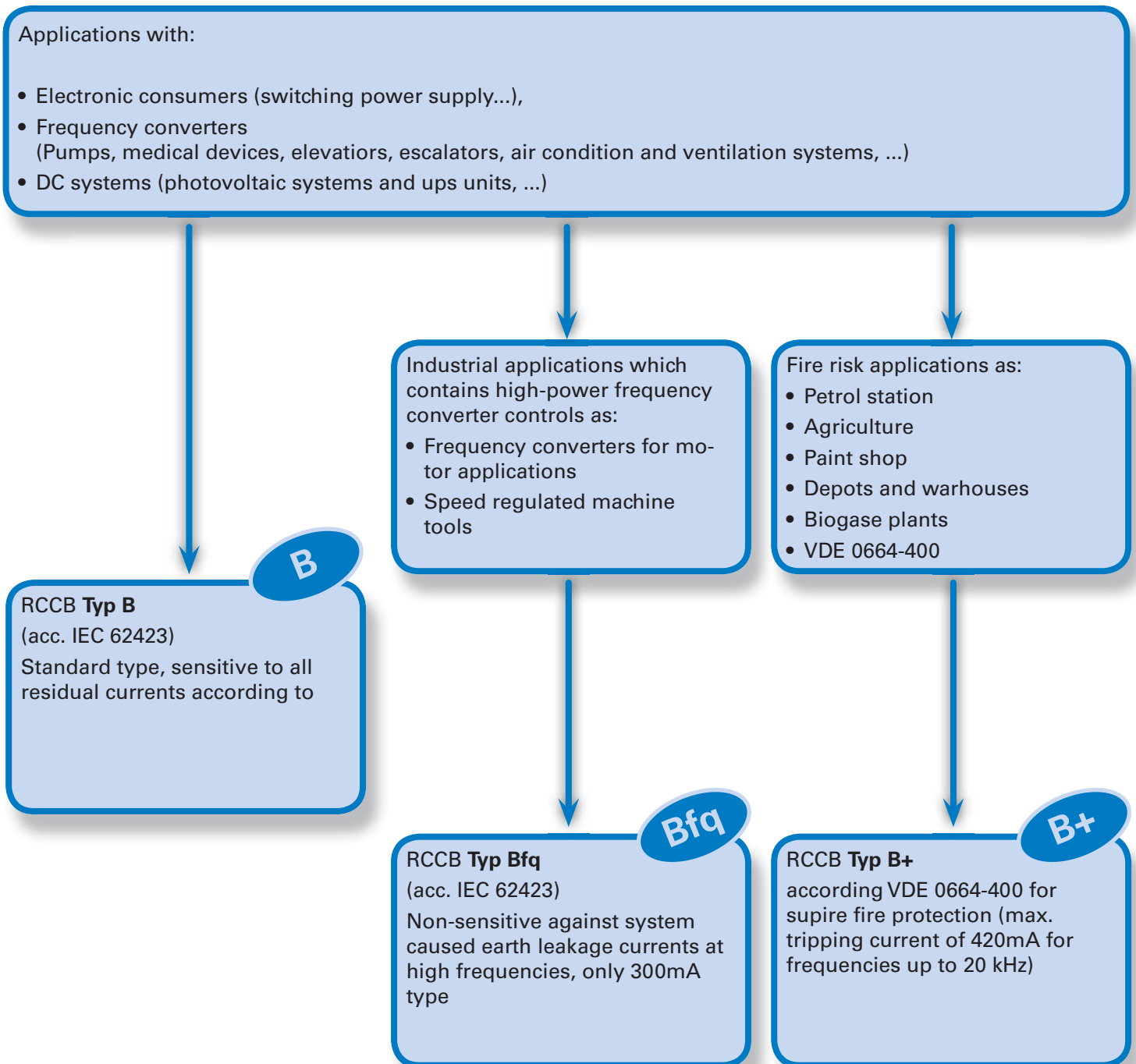

Description type designation RCD's

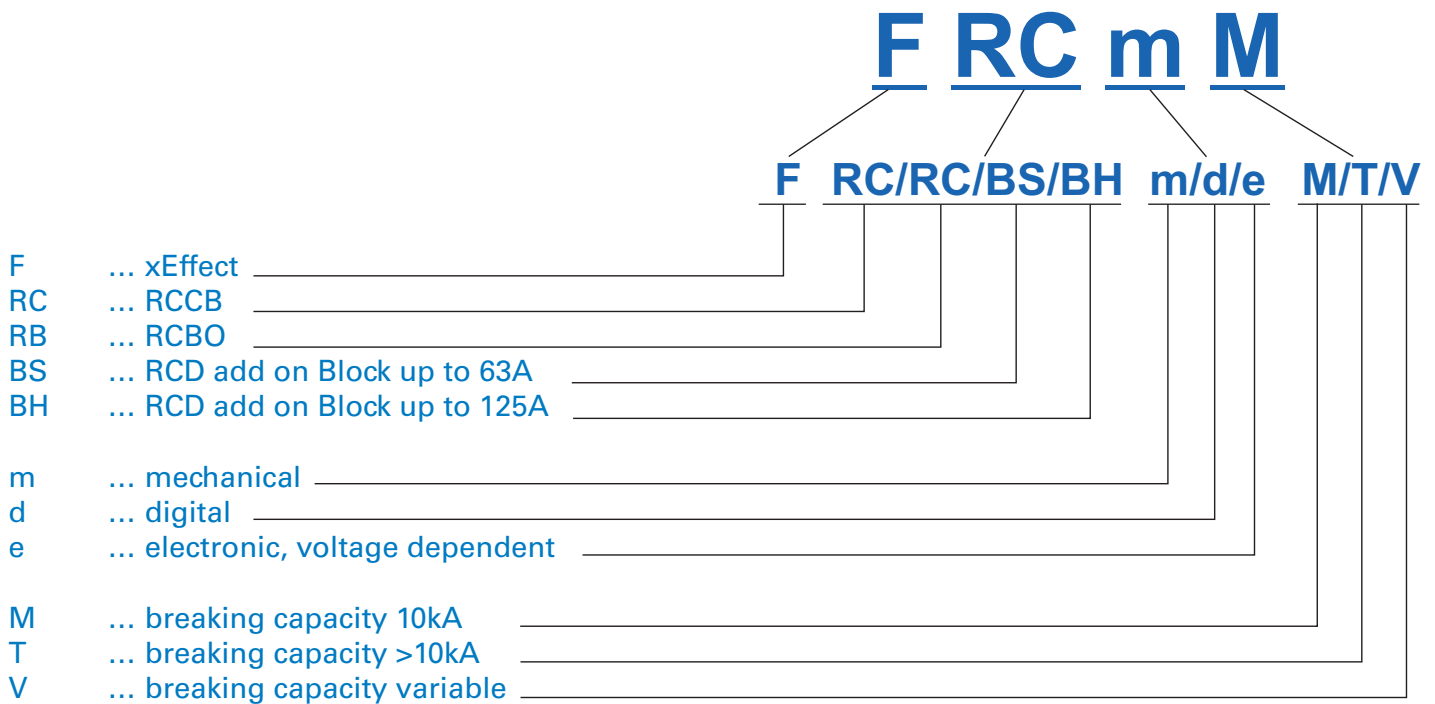

Description type designation MCB's

- FAZ ... MCBs up to 63A
- FAZT ... MCBS up to 40A with braking capacity >10kA
- AZ ... MCBs up to 125A

General definitions

- RCD ... Residual Current operated Device (umbrella term for RCCB and RCBO)
- RCCB ... Residual Current Circuit Breaker
- RCBO ... Residual Current Operated Circuit Breaker with Overcurrent Protection
- MCB ... Miniature Circuit Breaker

Table of Contents

1. Components

- RCCB
 - RCCB FRCdM Type A, U and R, Digital Page 4
 - RCCB FRCdM Type B, Bfq and B+, Digital Page 11
 - RCCB FRCmM Type AC, A, U and R Page 21
 - RCCB FRCmM Type F Page 33
 - RCCB FRCmM-NA Type A Page 39
 - RCCB FRCmM-NA-110 Type A Page 45
 - RCCB FRCmM-125 Type A, B, Bfq and B+ Page 51
 - Leakage Current Monitor PDIM Page 61

- Combined RCD/MCB Devices
 - Combined RCD/MCB Devices FRBdM 1+N, 2-poles Type A Digital Page 64
 - Combined RCD/MCB Devices FRBmM 1+N Type AC and A Page 78
 - Combined RCD/MCB Devices FRBmM, FRBm6, 2-poles Type AC and A Page 91
 - Combined RCD/MCB Devices FRBmM, 3-poles Type A Page 114
 - Combined RCD/MCB Devices FRBm6, FRBm4, 3+N-poles Type AC and A Page 124

- Add-on Residual Current Protection
 - Add-on Residual Current Protection FBSmV Type AC and A Page 133
 - Add-on Residual Current Protection FBHmV Type AC and A Page 140

Table of Contents

- **MCB**
 - MCB FAZ, FAZ-PN, FAZ-HS Page 147
 - MCB FAZ-T Page 194
 - MCB FAZ-DC Page 209
 - MCB FAZ-NA/RT Page 213
 - MCB FAZ-NA-DC Page 226
 - MCB AZ Page 230







- **Main Load Disconnecter Switch (Isolator) IS Page 240**

- **Busbar Systems**
 - Busbar System xEffect BB-EV Page 243
 - UL489-Busbar System Z-BB/UL (sliceable) Page 247
 - UL489-Busbar System Z-SV/UL Page 251
 - UL508-Busbar System BB-ULPage 255

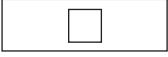
- **Accessories for Protective Devices**
 - Accessories for RCDs, MCBs, Combined RCD/MCB Devices Page 260
 - Accessories for Add-on Residual Current Protection FBHmV Page 276
 - Accessories for MCB AZ Page 278
 - Accessories for MCB FAZ-...-NA, -RT Page 284
 - Terminal Covers Page 285
 - Remote Control and Automatic Switching Device Z-FW Page 286

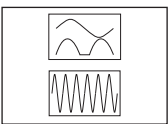
Residual Current Devices - General Data

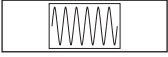
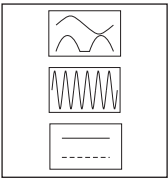
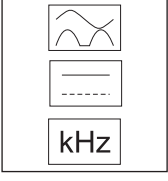
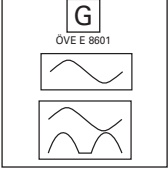
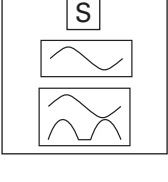
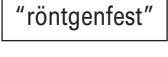
Short description of the most important RCD types:

Symbol	Description
	Eaton standard. Suitable for outdoor installation (distribution boxes for outdoor installation and building sites) up to -25° C.
	Conditionally surge-current proof (>250 A, 8/20 µs) for general application.
	Type AC: AC current sensitive RCCB
	Type A: AC and pulsating DC current sensitive RCCB
	Type F: AC and pulsating DC current sensitive RCCB, trip also at frequency composition (10 Hz, 50 Hz, 1000 Hz)
	Frequency range up to 20 kHz
	Trip also at frequency composition (10 Hz, 50 Hz, 1000 Hz)
	Type B: All-current sensitive RCD switchgear for applications where DC fault currents may occur. Non-selective, non-delayed. Protection against all kinds of fault currents.
	Type B+: All-current sensitive RCD switchgear for applications where DC fault currents may occur. Non-selective, non-delayed. Protection against all kinds of fault currents. Also meets the requirements of the VDE 0664-400 standard (formerly known as VDE V 0664-110) and therefore provides enhanced fire safety.
	RCD of type G (min 10 ms time delay) surge current-proof up to 3 kA. For system components where protection against unwanted tripping is compulsory to avoid personal injury and damage to property (§ 12.1.6 of ÖVE/ÖNORM E 8001-1). Also for systems involving long lines and high line capacity. Some versions are sensitive to pulsating DC. Some versions are available in all-current sensitive design.
	RCD of type S (selective, min 40 ms time delay) surge current-proof up to 5 kA. Mainly used as main switch according to ÖVE/ÖNORM E 8001-1 § 12.1.5, as well as in combination with surge arresters. This is the only RCD suitable for series connection with other types if the rated tripping current of the downstream RCD does not exceed one third of the rated tripping current of the device of type S. Some versions are sensitive to pulsating DC. Some versions are available in all-current sensitive design.
	"X-ray-proof", for avoiding unwanted tripping caused by x-ray devices.
	"Frequency converter-proof", for avoiding unwanted tripping caused by frequency converters, speed-controlled drives, etc.

Kind of residual current and correct use of RCD Types

Kind of current	Current profile	Correct use / application field of RCCB types						Tripping current
		AC	A	F	B	/ B+		
Sinusoidal AC residual current		✓	✓	✓	✓			0.5 to 1.0 $I_{\Delta n}$
Pulsating DC residual current (positive or negative half-wave)		-	✓	✓	✓			0.35 to 1.4 $I_{\Delta n}$
Cut half-wave current		-	✓	✓	✓			Lead angle 90°: 0.25 to 1.4 $I_{\Delta n}$ Lead angle 135°: 0.11 to 1.4 $I_{\Delta n}$
Half-wave with smooth DC current of 6 mA		-	✓	✓	✓			max. 1.4 $I_{\Delta n}$ + 6 mA
Half-wave with smooth DC current of 10 mA		-	-	✓	✓			max. 1.4 $I_{\Delta n}$ + 10 mA
Smooth DC current		-	-	-	✓			0.5 to 2.0 $I_{\Delta n}$

Tripping time

Classification		$I_{\Delta n}$	$2 \times I_{\Delta n}$	$5 \times I_{\Delta n}$	500 A
Standard RCCB	Max. tripping time (s)	0.3	0.15	0.04	0.04
<i>Conditionally surge current-proof 250 A</i>					
RCCB Type G (Short-time-delayed)	Min. non tripping time (s)	0.01	0.01	0.01	0.01
<i>Surge current-proof 3 kA</i>	Max. tripping time (s)	0.3	0.15	0.04	0.04
RCCB Type S (Selective)	Min. non tripping time (s)	0.13	0.06	0.05	0.04
<i>Surge current-proof 5 kA</i>	Max. tripping time (s)	0.5	0.2	0.15	0.15

Tripping Characteristics (IEC/EN 61008)

Tripping characteristics, tripping time range and selectivity of instantaneous, surge current-proof "G" and surge current-proof - selective "S" residual current devices.

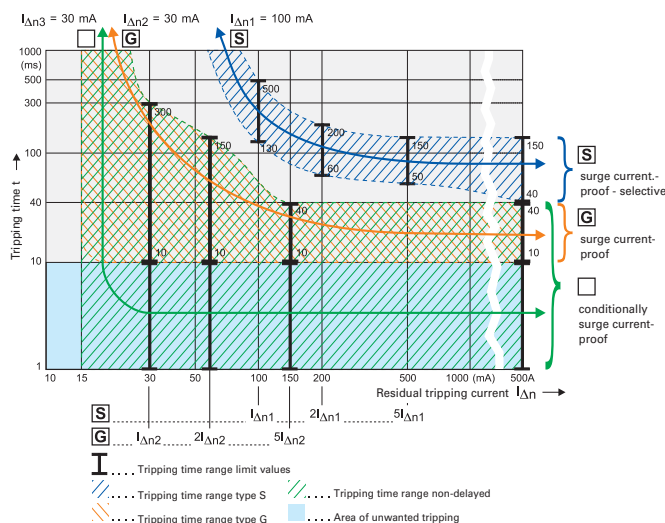

§ 6.1.1 of ÖVE/ÖNORM E 8001-1/A1 deals with **additional protection** and provides essentially the following:

In circuits with **sockets up to 16 A** with fault current/residual current protection by protective earthing, protective multiple earthing or residual current devices (RCDs), additional residual current protection devices with a rated tripping current of **0.03 A** must be installed.

This means when using RCDs for fault current/residual current protection two RCDs must be connected in series.

Testing:

RCDs with tripping time delay (Types -G and -S) may be function tested with conventional testing equipment which must be set according to the instructions for operation of the testing device. Due to reasons inherent in the measuring process, the tripping time determined in this way may be longer than expected in accordance with the specifications of the manufacturer of the measuring instrument.

However, the device is ok if the result of measurement is within the time range specified by the manufacturer of the measuring instrument.

Hints for the application of our frequency converter-proof RCDs:

Due to the currents flowing off through the filters (designated I_F), the sum of currents through the RCD is not exactly zero, which causes unwanted tripping.

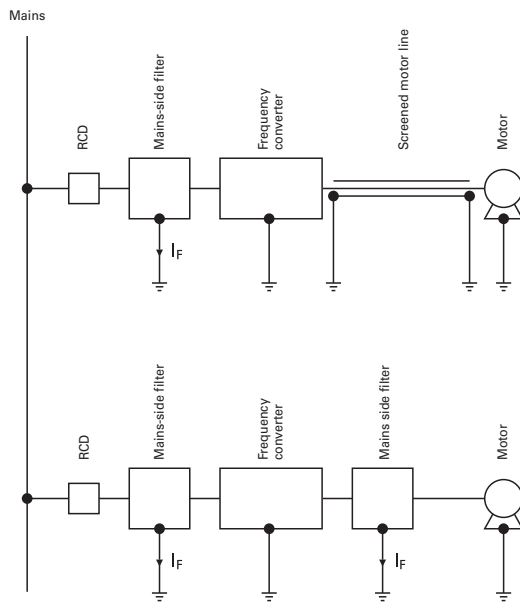

Frequency converters are used in a wide variety of systems and equipment requiring variable speed, such as lifts, escalators, conveyor belts, and large washing machines. Using them for such purposes in circuits with conventional residual current devices causes frequent problems with unwanted tripping.

The technical root cause of this phenomenon is the following: Fast switching operations involving high voltages cause high interference levels which propagate through the lines on the one hand, and in the form of interfering radiation on the other. In order to eliminate this problem, a mains-side filter (also referred to as input filter or EMC-filter) is connected between the RCD and frequency converter. The anti-interference capacitors in the filters produce discharge currents against earth which may cause unwanted tripping of the RCD due to the apparent residual currents. Connecting a filter on the output side between frequency converter and 3-phase AC motor results in the same behaviour.

Tripping characteristic

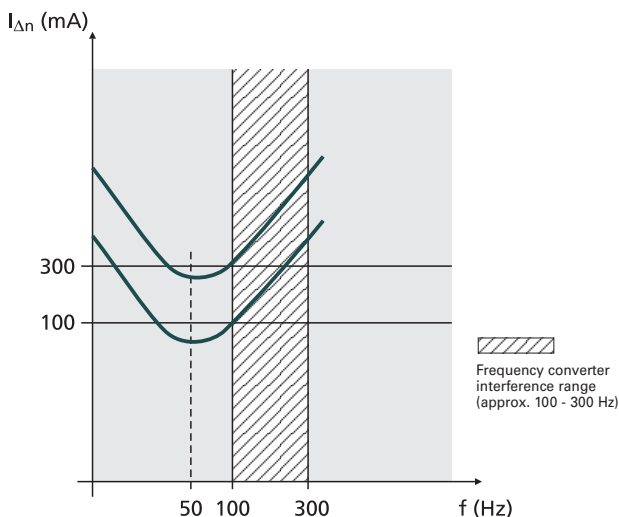

This sample tripping characteristic of a 100 mA RCD and a 300 mA RCD shows the following: In the frequency range around 50 Hz, the RCDs trip as required (50 - 100 % of the indicated $I_{\Delta n}$).

In the range shown hatched in the diagram, i. e. from approx. 100 to 300 Hz, unwanted tripping occurs frequently due to the use of frequency converters. Frequency converter-proof residual current devices are much less sensitive in this frequency range than in the 50 - 60 Hz range, which leads to an enormous increase in the reliability of systems.

Therefore, we recommend to use frequency converter-proof RCDs!

These special residual current devices can be recognised by an extension of the type designation ("-U"). They meet the requirements of compatibility between RCDs and frequency converters with respect to unwanted tripping.

These are **NOT AC/DC-sensitive** RCDs of type B !!!

Our RCDs of type **"-U"** are characterised by **SENSITIVITY TO RESIDUAL PULSATING DC** $\left[\text{X} \right]$ and **SELECTIVITY** $\left[\text{S} \right]$ or **SHORT-TIME DELAY** $\left[\text{G} \right]$.

Protective Measures

The following rules for the application of RCDs of type "-U" are only applicable in those cases where an RCD of type "-B" is not explicitly demanded in the instructions of the manufacturer of the frequency converter.

How can you make sure that the required protective measures are in place when using RCDs type "-U" and frequency converters in one system?

In Austria, the ÖVE Decision EN 219 is applicable.

In Germany, VDE 0100 is applicable, in Switzerland SEV 1000.

Under this standard

In case of application in any **other country** than those mentioned take into account national rules and recommendations.

- frequency converters must be equipped with current limiting devices in order to ensure disconnection in cause of faults or overload, and
- the installer of a system is obliged to make sure that additional equipotential bonding is provided (additional inclusion of all metal components, such as frequency converters, mains filters, motor filters, etc. into the existing equipotential bonding), in order to ensure that the permissible touch voltage of 50 V AC or 120 V DC is not exceeded. (In ÖVE/ÖNORM E 8001-1 the term "touch voltage" has been omitted. There is only a fault voltage limit of 65 V AC or 120 V DC which must not be exceeded).

Residual Current Devices FRCdM Type A, U and R, Digital

SG49712



- Line voltage independent RCCB for fault or additional protection with additional digital features.
- System Monitoring: Preventive information / warning before the RCD trips in case of leakage currents
 - Integrated auxiliary contact
 - Local Indication
- New level of accuracy -> reduced unwanted tripping
- Yearly test interval
- Comprehensive range of accessories
- Real contact position indicator
- Fault current tripping indicator
- Automatic re-setting possible
- Transparent designation plate

Residual Current Devices FRCdM Type G/A

Surge current-proof 3 kA, sensitive to residual pulsating DC, Type G/A

$I_n/I_{\Delta n}$ (A)	Type Designation	Article No.	Units per package
4-pole			
25/0.03	FRCdM-25/4/003-G/A	168646	1/30
25/0.3	FRCdM-25/4/03-G/A	168647	1/30
40/0.03	FRCdM-40/4/003-G/A	168648	1/30
40/0.3	FRCdM-40/4/03-G/A	168649	1/30
63/0.03	FRCdM-63/4/003-G/A	168650	1/30
63/0.3	FRCdM-63/4/03-G/A	168651	1/30
80/0.03	FRCdM-80/4/003-G/A	168634	1/30
80/0.3	FRCdM-80/4/03-G/A	168635	1/30



Residual Current Devices FRCdM Type R

Surge current-proof 3 kA, X-ray application, Type R

$I_n/I_{\Delta n}$ (A)	Type Designation	Article No.	Units per package
4-pole			
63/0.03	FRCdM-63/4/003-R	168636	1/30



Residual Current Devices FRCdM Type S/A

Selective + surge current-proof typ. 5 kA, sensitive to residual pulsating DC, Type S/A

$I_n/I_{\Delta n}$ (A)	Type Designation	Article No.	Units per package
4-pole			
40/0.3	FRCdM-40/4/03-S/A	168637	1/30
63/0.3	FRCdM-63/4/03-S/A	168638	1/30
80/0.3	FRCdM-80/4/03-S/A	168639	1/30



Residual Current Devices FRCdM Type U

Short-time delayed + surge current-proof 3 kA, Type U

$I_n/I_{\Delta n}$ (A)	Type Designation	Article No.	Units per package
4-pole			
40/0.03	FRCdM-40/4/003-U	168643	1/30
63/0.03	FRCdM-63/4/003-U	168640	1/30



Residual Current Devices FRCdM Type U

Selective + surge current-proof typ. 5 kA, frequency converter-proof, Type U 

	$I_n/I_{\Delta n}$ (A)	Type Designation	Article No.	Units per package
4-pole				
	40/0.3	FRCdM-40/4/03-U	168644	1/30
	63/0.3	FRCdM-63/4/03-U	168641	1/30
	80/0.3	FRCdM-80/4/03-U	168642	1/30

SG49712



Specifications | Residual Current Devices FRCdM

Description

- Residual current devices
 - Shape compatible with and suitable for standard busbar connection to other devices of the xEffect-series
 - Twin-purpose terminal (lift/open-mouthed) above and below
 - Busbar positioning optionally above or below
 - Free terminal space despite installed busbar
 - Universal tripping signal switch, also suitable for FAZ, FRBmM-1N can be mounted subsequently
 - Auxiliary switch Z-HK can be mounted subsequently
 - Contact position indicator red - green
 - Tripping indicator white - blue
 - Additional Safety
 - possibility to seal
 - possibility to lock in ON and OFF position
 - Delayed types suitable for being used with standard fluorescent tubes with or without electronical ballast (30mA-RCD: 30 units per phase conductor, 100mA-RCD: 90 units per phase conductor).
Notes: Depending of the fluorescent lamp ballast manufacturer partly more possible. Symmetrical allocation of the fluorescent lamp ballasts on all phases favourably. Shifting references of the fluorescent lamp ballast manufacturer consider.
 - The device functions irrespective of the position of installation
 - Tripping is line voltage-independent. Consequently, the RCD is suitable for "fault protection" and "additional protection" within the meaning of the applicable installation rules.
 - Mains connection at either side (except applications according to connection diagramm ②)
 - The 4-pole device can also be used for 3-pole connection: See connection possibilities.
 - The 4-pole device can also be used for 2-pole connection: See connection possibilities.
 - The test key "T" must be pressed every year. The system operator must be informed of this obligation and his responsibility in a way that can be proven. Under special conditions (e.g. damply and/or dusty environments, environments with polluting and/or corroding conditions, environments with large temperature fluctuations, installations with a risk of overvoltages due to switching of equipment and/or atmospheric discharges, portable equipment ...), it's recommended to test in monthly intervals. A test is further needed if red and yellow LED are on together.
 - Pressing the test key "T" serves the only purpose of function testing the residual current device (RCD). This test does not make earthing resistance measurement (R_E), or proper checking of the earth conductor condition redundant, which must be performed separately.
- **Functioning**
 - The green LED becomes active at 0-30% $I_{\Delta n}$
 - The yellow LED becomes active at 30-50% $I_{\Delta n}$
 - The red LED becomes active at >50% $I_{\Delta n}$
 - Tolerance: $\pm 5\%$
 - Potential-free auxiliary contact (NO contact, in parallel with the yellow LED, up to 0.25 A ohmic load / 240 V~) for external prewarning function. The potential-free auxiliary contact stay ON also when the breaker trips. After switching the breaker ON again, the contact will be reseted. The potential-free auxiliary contact (13, 14) provides only basic insulation from terminals 2, 4, 6, N of the RCCB. Without any additional protective measures (isolation transformer 1:1 according to IEC/EN 60664) the potential-free auxiliary contact (13, 14) may only be supplied from the terminals 2, 4, 6, N. See also connection diagrams ②, ③.
 - **Type -A:** Protects against special forms of residual pulsating DC which have not been smoothed.
 - **Type -G:** High reliability against unwanted tripping. Compulsory for any circuit where personal injury or damage to property may occur in case of unwanted tripping (ÖVE/ÖNORM E 8001-1 § 12.1.6).
 - **Type -G/A:** Additionally protects against special forms of residual pulsating DC which have not been smoothed.
 - **Type -R:** To avoid unwanted tripping due to X-ray devices.
 - **Type -S:** Selective residual current device sensitive to AC, Type -S. Compulsory for systems with surge arresters downstream of the RCD (ÖVE/ÖNORM E 8001-1 § 12.1.5).
 - **Type -S/A:** Additionally protects against special forms of residual pulsating DC which have not been smoothed.
 - **Type -U:** Suitable for speed-controlled drives with frequency converters in household, trade, and industry.
Unwanted tripping is avoided thanks to a tripping characteristic designed particularly for frequency converters.
See also explanation "Frequency Converter-Proof RCDs - What for?"
Application according to ÖVE/ÖNORM E 8001-1 and Decision EN 219 (1989), VDE 0100, SEV 1000.

Local Indication RCCB

Status indication LED

Permanent light green



red / yellow / green

Normal operation

Permanent light yellow



The measured residual current is higher than 30% of the nominal tripping value.

Permanent light red



The measured residual current is higher than 50% of the nominal tripping value.

Flashing yellow/red



Check the device with test key. If the LEDs are still flashing check the direction of connection (supply side / load side).

Remote Indication

Potential-free auxiliary contact for use in control circuits. The potential-free auxiliary contact (13, 14) provides only basic insulation from terminals 2, 4, 6, N of the RCCB. Without any additional protective measures (isolation transformer 1:1 according to IEC/EN 60664) the potential-free auxiliary contact (13, 14) may only be supplied from the terminals 2, 4, 6, N. See also connection diagrams. 0.25A ohmic load / 240V AC.

Accessories:

Auxiliary switch for subsequent installation to the left	Z-HK	248432
Tripping signal contact for subsequent installation to the right	Z-NHK	248434
Automatic restarting device	Z-FW/LP	248296
	Z-FW-LPD	265244
Remote control	Z-FW-MO	284730
	Z-FW-LP/MO	290171
Pre-mounted sets	Z-FW-LPD/MO	290172
	Z-FW/003	248298
	Z-FW/010	248299
Remote testing module	Z-FW/030	248300
	Z-FW/010	248299
Terminal cover 4-pole	Z-RC/AK-4TE	101062
Switching interlock	IS/SPE-1TE	101911

Technical Data

		FRCdM
Electrical		
Design according to		IEC/EN 61008 Type G and G/A acc. to ÖVE E 8601
Current test marks as printed onto the device		
Tripping		instantaneous
Type G , R		10 ms delay
Type S		40 ms delay - with selective disconnecting function
Type U (only 30 mA)		10 ms delay
Type U (except 30 mA)		40 ms delay - with selective disconnecting function
Rated voltage	U_n	240/415 V AC, 50Hz
Limits operation voltage electronic		50 – 264V AC
Limits operation voltage test circuit		
30, 300 mA		196 – 264V AC
Rated tripping current	$I_{\Delta n}$	30, 300 mA
Sensitivity		AC and pulsating DC
Rated insulation voltage	U_i	440 V
Rated impulse withstand voltage	U_{imp}	4 kV (1.2/50 μ s)
Rated short circuit capacity	I_{cn}	10 kA with back-up fuse
Peak withstand current		
Type G, G/A, R, U (30mA)		3 kA (8/20 μ s) surge current proof
Type S/A, U (except 30mA)		typ. 5 kA (8/20 μ s) selective + surge current proof
Rated breaking capacity or rated fault breaking capacity		
$I_n = 25-40$ A		500 A
$I_n = 63$ A		630 A
$I_n = 80$ A		800 A
Endurance		
electrical components		$\geq 4,000$ operating cycles
mechanical components		$\geq 20,000$ operating cycles
Mechanical		
Frame size		45 mm
Device height		80 mm
Device width		70 mm (4MU)
Mounting		quick fastening with 2 lock-in positions on DIN rail IEC/EN 60715
Degree of protection, built-in		IP40
Degree of protection in moisture-proof enclosure		IP54
Upper and lower terminals		open mouthed/lift terminals
Terminal protection		finger and hand touch safe, BGV A3, ÖVE-EN 6
Terminal capacity		1.5 - 35 mm ² single wire 2 x 16 mm ² multi wire
Terminal screw		M5 (with slotted screw acc. to EN ISO 4757-Z2, Pozidriv PZ2)
Terminal capacity warning contact(s)		0.25-1.5 mm ² (plug in terminals)
Terminal torque		2 - 2.4 Nm
Busbar thickness		0.8 - 2 mm
Operation temperature		-25°C to +40°C
Storage- and transport temperature		-35°C to +60°C
Resistance to climatic conditions		acc. to IEC/EN 61008
Contact position indicator		red / green
Tripping indicator		white / blue
Alarm contact		
Nominal switching capacity @ 30 V DC (resistive load)		2 A
Nominal switching capacity @ 240 V AC (resistive load)		0.25 A
Maximum switching power (resistive load)		60 W
Maximum switching voltage DC		220 V
Maximum switching voltage AC		240 V
Maximum switching current		2 A
Minimum switching capacity (Reference value)		10 μ A, 10 mV DC
Number of electrical operations		
Electrical (at 20 cpm) 2 A 30 V DC resistive		$>10^5$
Electrical (at 20 cpm) 1 A 30 V DC resistive		$>5 \times 10^5$
Terminals		0.25 – 1.5 mm ²

Connection diagram

4-pole

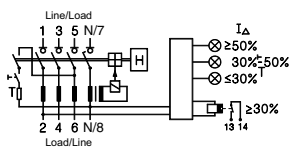

① Without use of auxiliary contact line/load side free selectable

4-pole

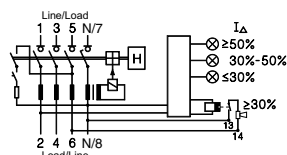

② Signalisation without Isolation Transformer 1:1 (IEC/EN 60664)

4-pole

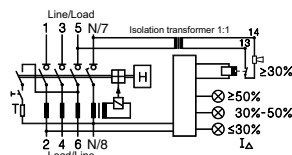

③ Signalisation with Isolation Transformer 1:1 (IEC/EN 60664)

Dimensions (mm)

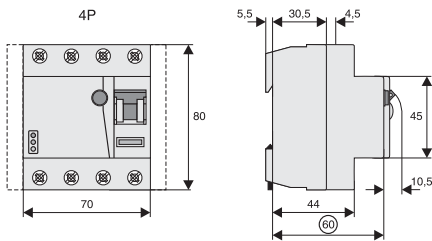

Correct connection

30, 300mA Types:

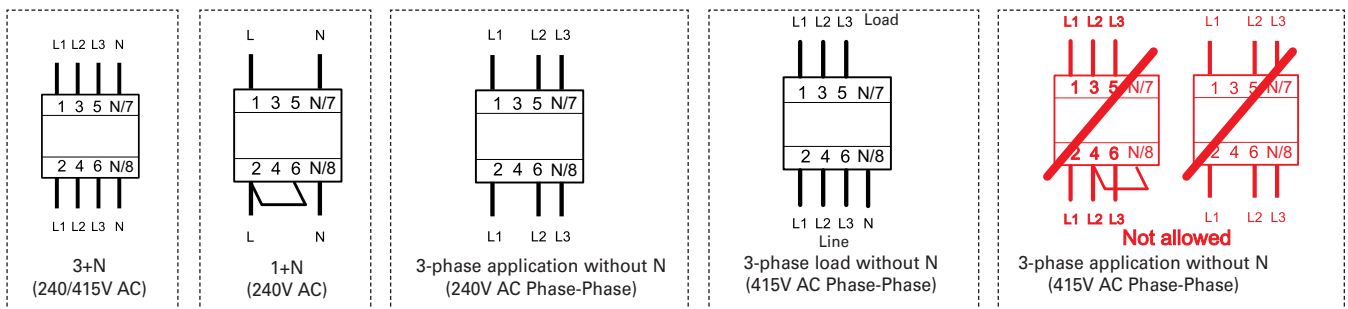

Electronic works within 50-264V AC !

- Disconnect load side of the switch gear, if you make a insulation test of the installation!

Internal Resistance FRCdM

At room temperature (single pole)

I_n [A]	Z^* [mΩ]
25	0.66
40	0.64
63	0.64
80	0.62

* 50Hz

Power Loss at I_n FRCdM

(entire unit)

I_n [A]	P^* [W]
25	2.2
40	3.8
63	8.5
80	12.9

* 50Hz

Max. back-up fuse FRCdM

I_n [A]	Short Circuit [A]	Overload [A]
25-63	63 gG/gI	63 gG/gI
80	80 gG/gI	80 gG/gI

Important:

In the case that the maximal possible operating current of the electrical installation don't exceed the rated current of the RCD only short circuit protection must be implemented.

Overload protection must be implemented in the case if the maximal possible operating current of the electrical installation can exceed the rated current of the RCD.

Residual Current Devices FRCdM Type B, Bfq and B+, Digital

SG49812



- All-current sensitive RCCB for fault or additional protection
- Digital Features to increase the system availability
- System Monitoring: Preventive information / warning before the RCD trips in case of leakage currents
 - Integrated auxiliary contact for remote pre-warning
 - Local Indication through 3 LEDs
- B+ types also meet the requirements of superior fire-protection systems according to VDE 0664-400 (formerly known as VDE V 0664-110)
- 4-pole types can also be used as 2-pole devices for photovoltaic applications
- New level of accuracy -> reduced unwanted tripping
- Yearly test interval
- Comprehensive range of accessories
- Real contact position indicator
- Fault current tripping indicator
- Automatic re-setting possible
- Transparent designation plate

Residual Current Devices FRCdM Type G/B

Surge current-proof 3 kA, AC-DC sensitive, Type G/B (ÖVE E 8601)   

$I_n/I_{\Delta n}$ (A)	Type Designation	Article No.	Units per package
4-pole			
25/0.03	FRCdM-25/4/003-G/B	167892	1/30
25/0.3	FRCdM-25/4/03-G/B	167896	1/30
40/0.03	FRCdM-40/4/003-G/B	167893	1/30
40/0.3	FRCdM-40/4/03-G/B	167897	1/30
63/0.03	FRCdM-63/4/003-G/B	167894	1/30
63/0.3	FRCdM-63/4/03-G/B	167898	1/30



Residual Current Devices FRCdM Type S/B

Selective + surge current-proof 5 kA, Type S/B   

$I_n/I_{\Delta n}$ (A)	Type Designation	Article No.	Units per package
4-pole			
25/0.3	FRCdM-25/4/03-S/B	167900	1/30
40/0.3	FRCdM-40/4/03-S/B	167901	1/30
63/0.3	FRCdM-63/4/03-S/B	167902	1/30



Residual Current Devices FRCdM Type G/Bfq

Surge current-proof 3 kA, AC-DC sensitive, Type G/Bfq (ÖVE E 8601)   

$I_n/I_{\Delta n}$ (A)	Type Designation	Article No.	Units per package
4-pole			
25/0,03	FRCdM-25/4/003-G/Bfq	179530	1/30
25/0,3	FRCdM-25/4/03-G/Bfq	167904	1/30
40/0,03	FRCdM-40/4/003-G/Bfq	179531	1/30
40/0,3	FRCdM-40/4/03-G/Bfq	167905	1/30
63/0,03	FRCdM-63/4/003-G/Bfq	179532	1/30
63/0,3	FRCdM-63/4/03-G/Bfq	167906	1/30



Residual Current Devices FRCdM Type S/Bfq

Selective + surge current-proof 5 kA, Type S/Bfq   

$I_n/I_{\Delta n}$ (A)	Type Designation	Article No.	Units per package
4-pole			
25/0.3	FRCdM-25/4/03-S/Bfq	167908	1/30
40/0.3	FRCdM-40/4/03-S/Bfq	167909	1/30
63/0.3	FRCdM-63/4/03-S/Bfq	167910	1/30



Residual Current Devices FRCdM Type G/B+

Surge current-proof 3 kA, Type G/B+ (ÖVE E 8601)



SG49812



4-pole

$I_n/I_{\Delta n}$ (A)	Type Designation	Article No.	Units per package
25/0.03	FRCdM-25/4/003-G/B+	167880	1/30
25/0.3	FRCdM-25/4/03-G/B+	167884	1/30
40/0.03	FRCdM-40/4/003-G/B+	167881	1/30
40/0.3	FRCdM-40/4/03-G/B+	167885	1/30
63/0.03	FRCdM-63/4/003-G/B+	167882	1/30
63/0.3	FRCdM-63/4/03-G/B+	167886	1/30

Residual Current Devices FRCdM Type S/B+

Selective + surge current-proof 5 kA, Type S/B+



SG49812



4-pole

$I_n/I_{\Delta n}$ (A)	Type Designation	Article No.	Units per package
25/0.3	FRCdM-25/4/03-S/B+	167888	1/30
40/0.3	FRCdM-40/4/03-S/B+	167889	1/30
63/0.3	FRCdM-63/4/03-S/B+	167890	1/30

Special types for 60 Hz Networks

Residual Current Devices FRCdM Type G/B

Surge current-proof 3 kA, AC-DC sensitive, Type G/B (ÖVE E 8601)



$I_n/I_{\Delta n}$ (A)	Type Designation	Article No.	Units per package
4-pole			
25/0,03	FRCdM-25/4/003-G/B/60Hz	180418	1/30
40/0,03	FRCdM-40/4/003-G/B/60Hz	180421	1/30
63/0,03	FRCdM-63/4/003-G/B/60Hz	180424	1/30



Residual Current Devices FRCdM Type G/Bfq

Surge current-proof 3 kA, AC-DC sensitive, Type G/Bfq (ÖVE E 8601)



$I_n/I_{\Delta n}$ (A)	Type Designation	Article No.	Units per package
4-pole			
25/0,03	FRCdM-25/4/003-G/Bfq/60Hz	180420	1/30
40/0,03	FRCdM-40/4/003-G/Bfq/60Hz	180423	1/30
63/0,03	FRCdM-63/4/003-G/Bfq/60Hz	180426	1/30



Residual Current Devices FRCdM Type G/B+

Surge current-proof 3 kA, Type G/B+ (ÖVE E 8601)



$I_n/I_{\Delta n}$ (A)	Type Designation	Article No.	Units per package
4-pole			
25/0,03	FRCdM-25/4/003-G/B+/60Hz	180419	1/30
25/0,3	FRCdM-25/4/03-G/B+	167884	1/30
40/0,03	FRCdM-40/4/003-G/B+/60Hz	180422	1/30
40/0,3	FRCdM-40/4/03-G/B+	167885	1/30
63/0,03	FRCdM-63/4/003-G/B+/60Hz	180425	1/30
63/0,3	FRCdM-63/4/03-G/B+	167886	1/30



Specifications | Residual Current Devices FRCdM - digital, Type B, Bfq and B+

Description

- Residual current devices, all-current sensitive
 - Shape compatible with and suitable for standard busbar connection to other devices of the xEffect- and xPole-series
 - Twin-purpose terminal (lift/open-mouthed) above and below
 - Busbar positioning optionally above or below
 - Free terminal space despite installed busbar
 - Universal tripping signal switch, also suitable for FAZ, FRBmM-1N can be mounted subsequently
 - Auxiliary switch Z-HK can be mounted subsequently
 - Contact position indicator red - green
 - Tripping indicator white - blue
 - Additional Safety
 - possibility to seal
 - possibility to lock in ON and OFF position
 - Delayed types (G, S) suitable for being used with standard fluorescent tubes with or without electronical ballast (30mA-RCD: 30 units per phase conductor).

Notes: Depending of the fluorescent lamp ballast manufacturer partly more possible. Symmetrical allocation of the fluorescent lamp ballasts on all phases favourably. Shifting references of the fluorescent lamp ballast manufacturer consider.
 - The device functions irrespective of the position of installation
 - The RCD is suitable for "fault protection" and "additional protection" within the meaning of the applicable installation rules.
 - The 4-pole device can also be used for 2- or 3-pole connection: See connection possibilities.
 - The test key "T" must be pressed every year. The system operator must be informed of this obligation and his responsibility in a way that can be proven. Under special conditions (e.g. damply and/or dusty environments, environments with polluting and/or corroding conditions, environments with large temperature fluctuations, installations with a risk of overvoltages due to switching of equipment and/or atmospheric discharges, portable equipment ...), it's recommended to test in monthly intervals. A test is further needed if red and yellow LED are flashing alternately.
 - Pressing the test key "T" serves the only purpose of function testing the residual current device (RCD). This test does not make earthing resistance measurement (R_E), or proper checking of the earth conductor condition redundant, which must be performed separately.
- **Functioning**
 - The green LED becomes active at 0-30% $I_{\Delta n}$
 - The yellow LED becomes active at 30-50% $I_{\Delta n}$
 - The red LED becomes active at >50% $I_{\Delta n}$
 - Tolerance: $\pm 5\%$
 - Potential-free auxiliary contact for use in control circuits, insulated from main circuit of the switch gear according to IEC/EN60664 (0.25A ohmic load / 240V AC) in parallel with the yellow LED, for external prewarning function. The potential-free auxiliary contact stays ON also when the breaker trips. After switching the breaker ON again the contact will be reseted. The potential-free contact (13, 14) provides only basic insulation from load side terminals of the RCCB. Without any additional protective measures (isolation transformer 1:1 according to IEC/EN 60664) the potential-free auxiliary contact (13, 14) may only be supplied from the load side terminals. See also connection diagrams.
 - **Type -G/B and G/B+:** High reliability against unwanted tripping. Compulsory for any circuit where personal injury or damage to property may occur in case of unwanted tripping (ÖVE/ÖNORM E 8001-1 § 12.1.6).
 - Protection against all types of fault currents.
 - **Type -S/B and S/B+:** Selective residual current device.
 - Protection against all types of fault currents.
 - **Type -S/Bfq:** Suitable for speed-controlled drives with frequency converters in household, trade, and industry. Unwanted tripping is avoided thanks to a tripping characteristic designed particularly for frequency converters.
 - Protection against all types of fault currents.

Local Indication RCCB

Status indication LED

Permanent light green



red / yellow / green

Normal operation

Permanent light yellow



The measured residual current is higher than 30% of the nominal tripping value.

Permanent light red



The measured residual current is higher than 50% of the nominal tripping value.

Flashing yellow/red



Check the device with test key. If the LEDs are still flashing check the direction of connection (supply side / load side).

Remote Indication

Potential-free auxiliary contact for use in control circuits. The potential-free auxiliary contact (13, 14) provides only basic insulation from load side terminals (2, 4, 6, N) of the RCCB. Without any additional protective measures (isolation transformer 1:1 according to IEC/EN 60664) the potential-free auxiliary contact (13, 14) may only be supplied from the load side terminals (2, 4, 6, N). See also connection diagrams ②, ③. 0.25A ohmic load / 240V AC.

Accessories:

Auxiliary switch for subsequent installation to the left	Z-HK	248432
Tripping signal contact for subsequent installation to the right	Z-NHK	248434
Automatic restarting device	Z-FW/LP	248296
	Z-FW-LPD	265244
Remote control	Z-FW-MO	284730
	Z-FW-LP/MO	290171
Pre-mounted sets	Z-FW-LPD/MO	290172
	Z-FW/001	248297
	Z-FW/003	248298
	Z-FW/010	248299
	Z-FW/030	248300
Remote testing module	Z-FW/050	248301
	Z-FW/050	248301
Terminal cover 4-pole	Z-RC/AK-4TE	101062
Switching interlock	IS/SPE-1TE	101911

Technical Data

		FRCdM Type B, Bfq and B+
Electrical		
Design according to		Types B and Bfq acc. to IEC/EN 61008, IEC/EN 62423 Types B+ acc. to VDE 0664-400, formerly known as VDE V 0664-110 Type G/B, G/Bfq and G/B+ additional acc. to ÖVE E 8601
Current test marks as printed onto the device		
Tripping		
Type G		10 ms delay
Type S		40 ms delay - with selective disconnecting function
Rated voltage	U_n	240/415 V AC, 50 Hz (Special types for 60 Hz Networks available)
Limits operation voltage electronic		50 – 456V AC
Limits operation voltage test circuit		
30 mA		196 - 264V AC
300 mA		196 - 456V AC
Rated tripping current	$I_{\Delta n}$	30, 300 mA
Sensitivity		All types of current
Rated insulation voltage	U_i	440 V
Rated impulse withstand voltage	U_{imp}	4 kV (1.2/50µs)
Rated short circuit capacity	I_{cn}	10 kA with back-up fuse
Peak withstand current		
Type G/B, G/B+ and G/Bfq		3 kA (8/20 µs) surge current proof
Type S/B, S/B+ and S/Bfq		typ. 5 kA (8/20 µs) selective + surge current proof
Rated breaking capacity or rated fault breaking capacity		
$I_n = 25-40A$		500 A
$I_n = 63A$		630 A
Endurance		
electrical components		≥ 4,000 operating cycles
mechanical components		≥ 20,000 operating cycles
Mechanical		
Frame size		45 mm
Device height		80 mm
Device width		70 mm (4MU)
Mounting		quick fastening with 2 lock-in positions on DIN rail IEC/EN 60715
Degree of protection, built-in		IP40
Degree of protection in moisture-proof enclosure		IP54
Upper and lower terminals		open mouthed/lift terminals
Terminal protection		finger and hand touch safe, BGV A3, ÖVE-EN 6
Terminal capacity		1.5 - 35 mm ² single wire 2 x 16 mm ² multi wire
Terminal screw		M5 (with slotted screw acc. to EN ISO 4757-Z2, Pozidriv PZ2)
Terminal capacity warning contact		0.25-1.5 mm ² (plug in terminals)
Terminal torque		2 - 2.4 Nm
Busbar thickness		0.8 - 2 mm
Operation temperature		
25-40 A		-25°C to +55°C
63 A		-25°C to +45°C
Storage- and transport temperature		-35°C to +60°C
Resistance to climatic conditions		25-55°C/90-95% relative humidity acc. to IEC 60068-2
Contact position indicator		red / green
Tripping indicator		white / blue
Alarm contact		
Nominal switching capacity @ 30 V DC (resistive load)		2 A
Nominal switching capacity @ 240 V AC (resistive load)		0.25 A
Maximum switching power (resistive load)		60 W
Maximum switching voltage DC		220 V
Maximum switching voltage AC		240 V
Maximum switching current		2 A
Minimum switching capacity (Reference value)		10 µA, 10 mV DC
Number of electrical operations		
Electrical (at 20 cpm) 2 A 30 V DC resistive		>10 ⁵
Electrical (at 20 cpm) 1 A 30 V DC resistive		>5 x 10 ⁵
Terminals		0.25 – 1.5 mm ²

Connection diagram

4-pole

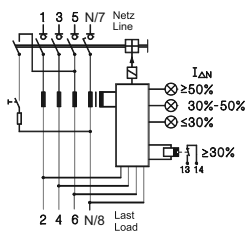

① Basic diagram

4-pole

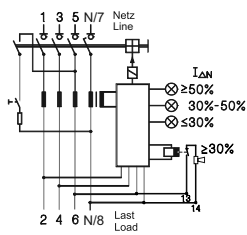

② Signalisation without Isolation Transformer 1:1 (IEC/EN 60664)

4-pole

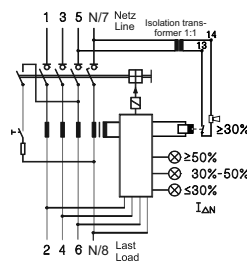

③ Signalisation with Isolation Transformer 1:1 (IEC/EN 60664)

Dimensions (mm)

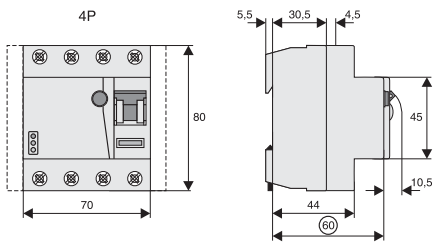

Correct connection

30mA Types:

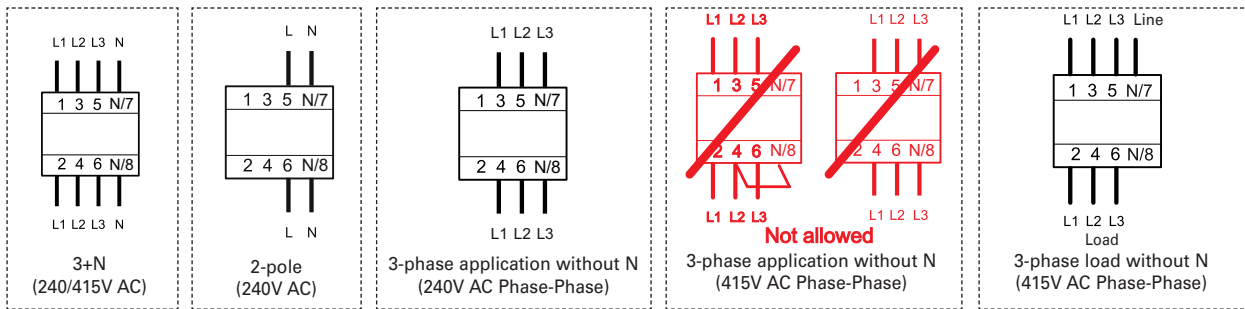

300mA Types:

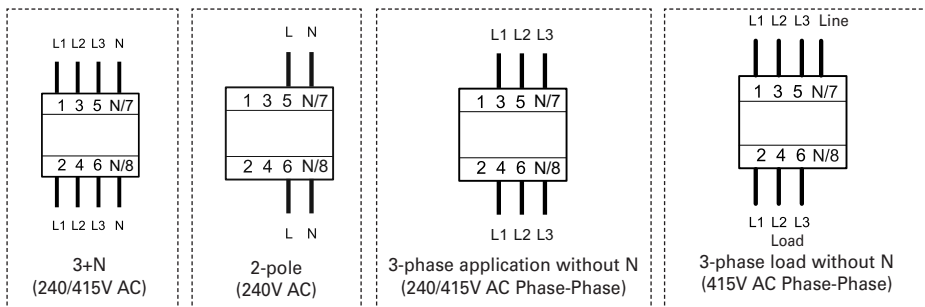

- Disconnect load side of the switch gear, if you make a insulation test of the installation!
- Please take care of supply side and load side!

Tripping current frequency response FRCdM Type B, Bfq and B+

Type B 30mA

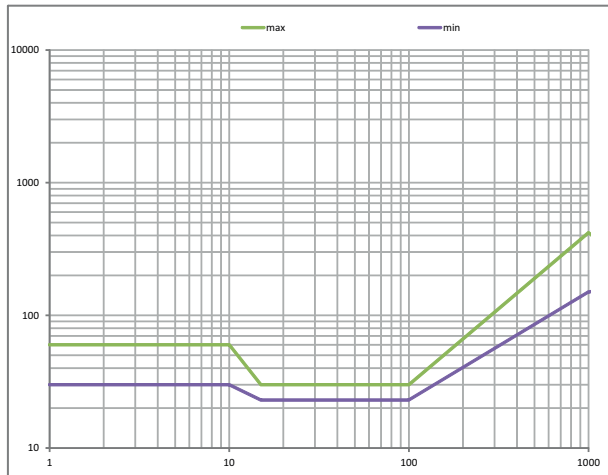

Type B 300mA

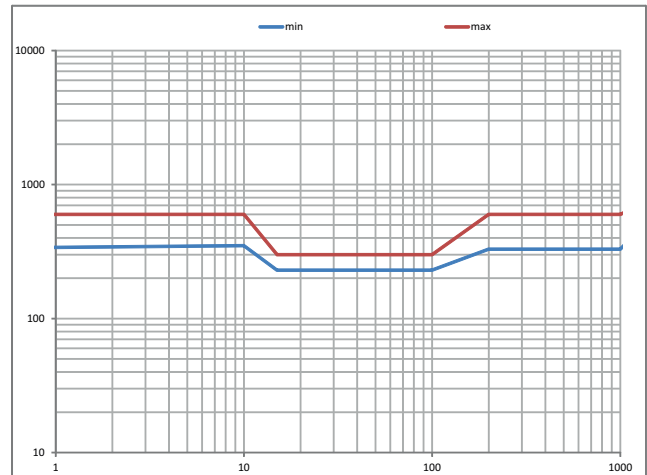

Type B+ 30mA

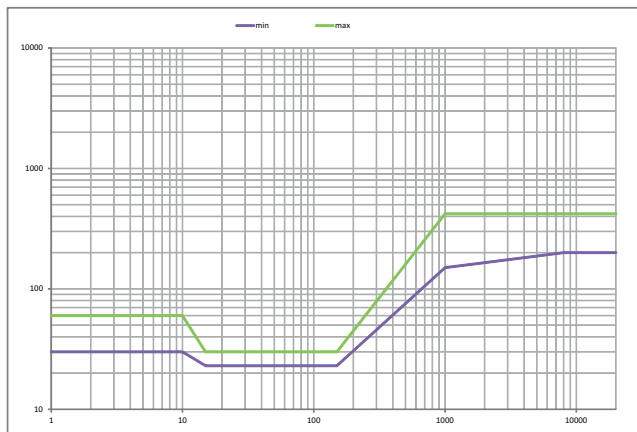

Type B+ 300mA

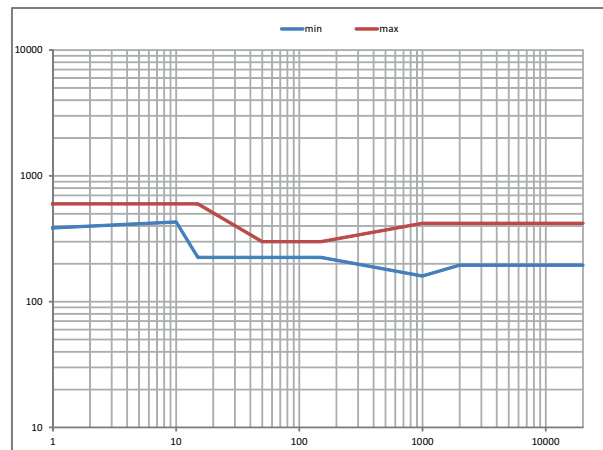

Type Bfq 30mA

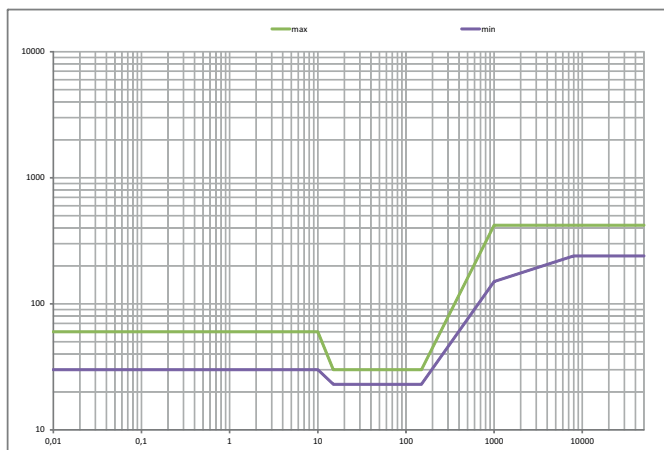

Type Bfq 300mA

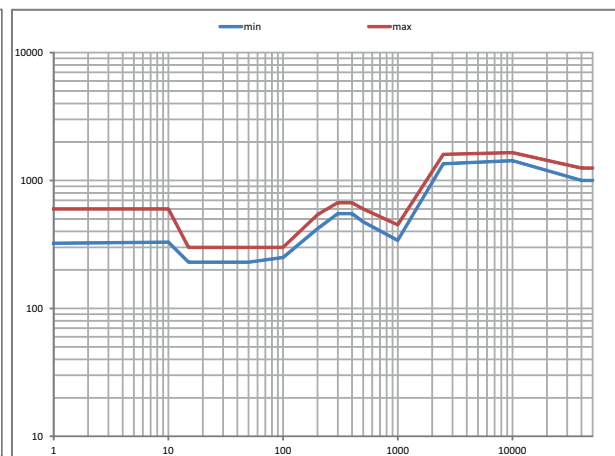

Power Loss at I_n FRCdM Type B, Bfq and B+

(entire unit)

I_n [A]	P^* [W]
25	4.6
40	6.2
63	10.0

* 50Hz

Impact of ambient temperature on the maximum permanent current allowed (A) FRCdM Type B, Bfq and B+

Ambient temperature	25A	40A	63A
	4p	4p	4p
40°	25	40	63
45°	25	40	63
50°	25	40	40
55°	25	40	40
60°	25	25	25
65°	-	-	-
70°	-	-	-
75°	-	-	-

Note: Please make sure that these values are not exceeded and that any upstream thermal overload protection switches off in time.

Max. back-up fuse FRCdM Typ B, Bfq und B+

I_n [A]	Short Circuit [A]	Overload [A]
25-63	63 gG/gl	63 gG/gl

Important:

In the case that the maximal possible operating current of the electrical installation don't exceed the rated current of the RCD only short circuit protection must be implemented.

Overload protection must be implemented in the case if the maximal possible operating current of the electrical installation can exceed the rated current of the RCD.

Residual Current Devices FRCmM Type AC, A, U and R



SG02613



- A complete spectrum of compact residual current devices for a wide range of applications
- For fault current/residual current protection and additional protection
- Wide variety of nominal currents
- Comprehensive range of accessories
- Real contact position indicator
- Automatic re-setting possible

Residual Current Devices FRCmM Type AC



Conditionally surge current-proof 250 A, Type AC

	$I_n/I_{\Delta n}$ (A)	Type Designation	Article No.	Units per package
2-pole				
	16/0.03	FRCmM-16/2/003	170390	1/60
	16/0.1	FRCmM-16/2/01	170396	1/60
	16/0.3	FRCmM-16/2/03	170402	1/60
	16/0.5	FRCmM-16/2/05	170405	1/60
	25/0.03	FRCmM-25/2/003	170391	1/60
	25/0.1	FRCmM-25/2/01	170397	1/60
	25/0.3	FRCmM-25/2/03	170403	1/60
	25/0.5	FRCmM-25/2/05	170406	1/60
	40/0.03	FRCmM-40/2/003	170392	1/60
	40/0.1	FRCmM-40/2/01	170398	1/60
	40/0.3	FRCmM-40/2/03	170404	1/60
	40/0.5	FRCmM-40/2/05	170407	1/60
	63/0.03	FRCmM-63/2/003	170393	1/60
	63/0.1	FRCmM-63/2/01	170399	1/60
	63/0.5	FRCmM-63/2/05	170408	1/60
	80/0.03	FRCmM-80/2/003	170394	1/60
	80/0.1	FRCmM-80/2/01	170400	1/60
	100/0.03	FRCmM-100/2/003	170395	1/60
	100/0.1	FRCmM-100/2/01	170401	1/60
	4-pole			
	16/0.03	FRCmM-16/4/003	170409	1/30
	16/0.1	FRCmM-16/4/01	170415	1/30
	16/0.3	FRCmM-16/4/03	170418	1/30
	16/0.5	FRCmM-16/4/05	170424	1/30
	25/0.03	FRCmM-25/4/003	170410	1/30
	25/0.1	FRCmM-25/4/01	170416	1/30
	25/0.3	FRCmM-25/4/03	170419	1/30
	25/0.5	FRCmM-25/4/05	170425	1/30
	40/0.03	FRCmM-40/4/003	170411	1/30
	40/0.1	FRCmM-40/4/01	170417	1/30
	40/0.3	FRCmM-40/4/03	170420	1/30
	40/0.5	FRCmM-40/4/05	170426	1/30
	63/0.03	FRCmM-63/4/003	170412	1/30
	63/0.3	FRCmM-63/4/03	170421	1/30
	63/0.5	FRCmM-63/4/05	170427	1/30
	80/0.03	FRCmM-80/4/003	170413	1/30
	80/0.3	FRCmM-80/4/03	170422	1/30
	80/0.5	FRCmM-80/4/05	170428	1/30
	100/0.03	FRCmM-100/4/003	170414	1/30
	100/0.3	FRCmM-100/4/03	170423	1/30
100/0.5	FRCmM-100/4/05	170429	1/30	

Residual Current Devices FRCmM Type A



Conditionally surge current-proof 250 A, sensitive to residual pulsating DC, Type A



	$I_n/I_{\Delta n}$ (A)	Type Designation	Article No.	Units per package
2-pole				
	16/0.03	FRCmM-16/2/003-A	170430	1/60
	16/0.1	FRCmM-16/2/01-A	170436	1/60
	16/0.3	FRCmM-16/2/03-A	170278	1/60
	16/0.5	FRCmM-16/2/05-A	170281	1/60
	25/0.03	FRCmM-25/2/003-A	170431	1/60
	25/0.1	FRCmM-25/2/01-A	170437	1/60
	25/0.3	FRCmM-25/2/03-A	170279	1/60
	25/0.5	FRCmM-25/2/05-A	170282	1/60
	40/0.03	FRCmM-40/2/003-A	170432	1/60
	40/0.1	FRCmM-40/2/01-A	170274	1/60
	40/0.3	FRCmM-40/2/03-A	170280	1/60
	40/0.5	FRCmM-40/2/05-A	170283	1/60
	63/0.03	FRCmM-63/2/003-A	170433	1/60
	63/0.1	FRCmM-63/2/01-A	170275	1/60
	63/0.5	FRCmM-63/2/05-A	170284	1/60
	80/0.03	FRCmM-80/2/003-A	170434	1/60
	80/0.1	FRCmM-80/2/01-A	170276	1/60
	100/0.03	FRCmM-100/2/003-A	170435	1/60
	100/0.1	FRCmM-100/2/01-A	170277	1/60
4-pole				
	16/0.03	FRCmM-16/4/003-A	170285	1/30
	16/0.1	FRCmM-16/4/01-A	170337	1/30
	16/0.3	FRCmM-16/4/03-A	170340	1/30
	16/0.5	FRCmM-16/4/05-A	170346	1/30
	25/0.03	FRCmM-25/4/003-A	170332	1/30
	25/0.1	FRCmM-25/4/01-A	170338	1/30
	25/0.3	FRCmM-25/4/03-A	170341	1/30
	25/0.5	FRCmM-25/4/05-A	170347	1/30
	40/0.03	FRCmM-40/4/003-A	170333	1/30
	40/0.1	FRCmM-40/4/01-A	170339	1/30
	40/0.3	FRCmM-40/4/03-A	170342	1/30
	40/0.5	FRCmM-40/4/05-A	170348	1/30
	63/0.03	FRCmM-63/4/003-A	170334	1/30
	63/0.3	FRCmM-63/4/03-A	170343	1/30
	63/0.5	FRCmM-63/4/05-A	170349	1/30
	80/0.03	FRCmM-80/4/003-A	170335	1/30
	80/0.3	FRCmM-80/4/03-A	170344	1/30
	80/0.5	FRCmM-80/4/05-A	170350	1/30
	100/0.03	FRCmM-100/4/003-A	170336	1/30
100/0.3	FRCmM-100/4/03-A	170345	1/30	
100/0.5	FRCmM-100/4/05-A	170351	1/30	



Residual Current Devices FRCmM Type G

Surge current-proof 3 kA, Type G (ÖVE E 8601)

	$I_n/I_{\Delta n}$ (A)	Type Designation	Article No.	Units per package
2-pole				
	16/0.03	FRCmM-16/2/003-G	170352	1/60
	16/0.1	FRCmM-16/2/01-G	170358	1/60
	16/0.3	FRCmM-16/2/03-G	170364	1/60
	25/0.03	FRCmM-25/2/003-G	170353	1/60
	25/0.1	FRCmM-25/2/01-G	170359	1/60
	25/0.3	FRCmM-25/2/03-G	170365	1/60
	40/0.03	FRCmM-40/2/003-G	170354	1/60
	40/0.1	FRCmM-40/2/01-G	170360	1/60
	40/0.3	FRCmM-40/2/03-G	170366	1/60
	63/0.03	FRCmM-63/2/003-G	170355	1/60
	63/0.1	FRCmM-63/2/01-G	170361	1/60
	80/0.03	FRCmM-80/2/003-G	170356	1/60
	80/0.1	FRCmM-80/2/01-G	170362	1/60
	100/0.03	FRCmM-100/2/003-G	170357	1/60
100/0.1	FRCmM-100/2/01-G	170363	1/60	
4-pole				
	16/0.03	FRCmM-16/4/003-G	170367	1/30
	16/0.1	FRCmM-16/4/01-G	170373	1/30
	16/0.3	FRCmM-16/4/03-G	170376	1/30
	25/0.03	FRCmM-25/4/003-G	170368	1/30
	25/0.1	FRCmM-25/4/01-G	170374	1/30
	25/0.3	FRCmM-25/4/03-G	170377	1/30
	40/0.03	FRCmM-40/4/003-G	170369	1/30
	40/0.1	FRCmM-40/4/01-G	170375	1/30
	40/0.3	FRCmM-40/4/03-G	170378	1/30
	63/0.03	FRCmM-63/4/003-G	170370	1/30
	63/0.3	FRCmM-63/4/03-G	170379	1/30
	80/0.03	FRCmM-80/4/003-G	170371	1/30
	80/0.3	FRCmM-80/4/03-G	170380	1/30
	100/0.03	FRCmM-100/4/003-G	170372	1/30
100/0.3	FRCmM-100/4/03-G	170381	1/30	

Residual Current Devices FRCmM Type G/A

Surge current-proof 3 kA, sensitive to residual pulsating DC, Type G/A (ÖVE E 8601) 

	$I_n/I_{\Delta n}$ (A)	Type Designation	Article No.	Units per package
2-pole				
	16/0.03	FRCmM-16/2/003-G/A	170382	1/60
	16/0.1	FRCmM-16/2/01-G/A	170388	1/60
	16/0.3	FRCmM-16/2/03-G/A	170290	1/60
	25/0.03	FRCmM-25/2/003-G/A	170383	1/60
	25/0.1	FRCmM-25/2/01-G/A	170389	1/60
	25/0.3	FRCmM-25/2/03-G/A	170291	1/60
	40/0.03	FRCmM-40/2/003-G/A	170384	1/60
	40/0.1	FRCmM-40/2/01-G/A	170286	1/60
	40/0.3	FRCmM-40/2/03-G/A	170292	1/60
	63/0.03	FRCmM-63/2/003-G/A	170385	1/60
	63/0.1	FRCmM-63/2/01-G/A	170287	1/60
	80/0.03	FRCmM-80/2/003-G/A	170386	1/60
	80/0.1	FRCmM-80/2/01-G/A	170288	1/60
	100/0.03	FRCmM-100/2/003-G/A	170387	1/60
	100/0.1	FRCmM-100/2/01-G/A	170289	1/60
4-pole				
	16/0.03	FRCmM-16/4/003-G/A	170293	1/30
	16/0.1	FRCmM-16/4/01-G/A	170299	1/30
	16/0.3	FRCmM-16/4/03-G/A	170302	1/30
	25/0.03	FRCmM-25/4/003-G/A	170294	1/30
	25/0.1	FRCmM-25/4/01-G/A	170300	1/30
	25/0.3	FRCmM-25/4/03-G/A	170303	1/30
	40/0.03	FRCmM-40/4/003-G/A	170295	1/30
	40/0.1	FRCmM-40/4/01-G/A	170301	1/30
	40/0.3	FRCmM-40/4/03-G/A	170304	1/30
	63/0.03	FRCmM-63/4/003-G/A	170296	1/30
	63/0.3	FRCmM-63/4/03-G/A	170305	1/30
	80/0.03	FRCmM-80/4/003-G/A	170297	1/30
	80/0.3	FRCmM-80/4/03-G/A	170306	1/30
	100/0.03	FRCmM-100/4/003-G/A	170298	1/30
	100/0.3	FRCmM-100/4/03-G/A	170307	1/30

Residual Current Devices FRCmM Type S

Selective + surge current-proof 5 kA, Type S

	$I_n/I_{\Delta n}$ (A)	Type Designation	Article No.	Units per package
2-pole				
 SG02713	16/0.1	FRCmM-16/2/01-S	170314	1/60
	25/0.1	FRCmM-25/2/01-S	170315	1/60
	40/0.1	FRCmM-40/2/01-S	170316	1/60
	63/0.1	FRCmM-63/2/01-S	170317	1/60
	80/0.1	FRCmM-80/2/01-S	170318	1/60
	100/0.1	FRCmM-100/2/01-S	170319	1/60
4-pole				
 SG02613	16/0.1	FRCmM-16/4/01-S	170320	1/30
	16/0.3	FRCmM-16/4/03-S	170324	1/30
	25/0.1	FRCmM-25/4/01-S	170321	1/30
	25/0.3	FRCmM-25/4/03-S	170325	1/30
	40/0.1	FRCmM-40/4/01-S	170322	1/30
	40/0.3	FRCmM-40/4/03-S	170326	1/30
	63/0.1	FRCmM-63/4/01-S	170323	1/30
	63/0.3	FRCmM-63/4/03-S	170327	1/30
	80/0.3	FRCmM-80/4/03-S	170328	1/30
		100/0.3	FRCmM-100/4/03-S	170329

Residual Current Devices FRCmM Type S/A

Selective + surge current-proof 5 kA, sensitive to residual pulsating DC, Type S/A

	$I_n/I_{\Delta n}$ (A)	Type Designation	Article No.	Units per package
2-pole				
 SG02713	16/0.1	FRCmM-16/2/01-S/A	170330	1/60
	25/0.1	FRCmM-25/2/01-S/A	170331	1/60
	40/0.1	FRCmM-40/2/01-S/A	170438	1/60
	63/0.1	FRCmM-63/2/01-S/A	170439	1/60
	80/0.1	FRCmM-80/2/01-S/A	170440	1/60
		100/0.1	FRCmM-100/2/01-S/A	170441
4-pole				
 SG02613	16/0.1	FRCmM-16/4/01-S/A	170442	1/30
	16/0.3	FRCmM-16/4/03-S/A	170446	1/30
	25/0.1	FRCmM-25/4/01-S/A	170443	1/30
	25/0.3	FRCmM-25/4/03-S/A	170447	1/30
	40/0.1	FRCmM-40/4/01-S/A	170444	1/30
	40/0.3	FRCmM-40/4/03-S/A	170448	1/30
	63/0.1	FRCmM-63/4/01-S/A	170445	1/30
	63/0.3	FRCmM-63/4/03-S/A	170449	1/30
	80/0.3	FRCmM-80/4/03-S/A	170450	1/30
		100/0.3	FRCmM-100/4/03-S/A	170451

Residual Current Devices FRCmM Type U

Short-time delayed + surge current-proof 3 kA, frequency converter-proof, Type U 

$I_n/I_{\Delta n}$ (A)	Type Designation	Article No.	Units per package
4-pole			
16/0.03	FRCmM-16/4/003-U	170452	1/30
25/0.03	FRCmM-25/4/003-U	170453	1/30
40/0.03	FRCmM-40/4/003-U	170454	1/30
63/0.03	FRCmM-63/4/003-U	170455	1/30
80/0.03	FRCmM-80/4/003-U	170456	1/30
100/0.03	FRCmM-100/4/003-U	170457	1/30



Residual Current Devices FRCmM Type U

Selective + surge current-proof 5 kA, frequency converter-proof, Type U 

$I_n/I_{\Delta n}$ (A)	Type Designation	Article No.	Units per package
4-pole			
16/0.1	FRCmM-16/4/01-U	170458	1/30
16/0.3	FRCmM-16/4/03-U	170462	1/30
25/0.1	FRCmM-25/4/01-U	170459	1/30
25/0.3	FRCmM-25/4/03-U	170463	1/30
40/0.1	FRCmM-40/4/01-U	170460	1/30
40/0.3	FRCmM-40/4/03-U	170464	1/30
63/0.1	FRCmM-63/4/01-U	170461	1/30
63/0.3	FRCmM-63/4/03-U	170465	1/30
80/0.3	FRCmM-80/4/03-U	170466	1/30
100/0.3	FRCmM-100/4/03-U	170467	1/30



Residual Current Devices FRCmM Type R

Surge current-proof 3 kA, X-ray application, Type R 

$I_n/I_{\Delta n}$ (A)	Type Designation	Article No.	Units per package
4-pole			
16/0.03	FRCmM-16/4/003-R	170308	1/30
25/0.03	FRCmM-25/4/003-R	170309	1/30
40/0.03	FRCmM-40/4/003-R	170310	1/30
63/0.03	FRCmM-63/4/003-R	170311	1/30
80/0.03	FRCmM-80/4/003-R	170312	1/30
100/0.03	FRCmM-100/4/003-R	170313	1/30



Specifications | Residual Current Devices FRCmM

Description

- Residual current devices
- Shape compatible with and suitable for standard busbar connection to other devices of the xEffect-series
- Twin-purpose terminal (lift/open-mouthed) above and below
- Busbar positioning optionally above or below
- Free terminal space despite installed busbar
- Universal tripping signal switch, also suitable for FAZ, FRBmM-1N can be mounted subsequently
- Auxiliary switch Z-HK can be mounted subsequently
- Contact position indicator red - green
- Delayed types suitable for being used with standard fluorescent tubes with or without electronical ballast (30mA-RCD: 30 units per phase conductor, 100mA-RCD: 90 units per phase conductor).
Notes: Depending of the fluorescent lamp ballast manufacturer partly more possible. Symmetrical allocation of the fluorescent lamp ballasts on all phases favourably. Shifting references of the fluorescent lamp ballast manufacturer consider.
- The device functions irrespective of the position of installation
- Tripping is line voltage-independent. Consequently, the RCD is suitable for "fault current/residual current protection" and "additional protection" within the meaning of the applicable installation rules.
- Mains connection at either side
- The 4-pole device can also be used for 2- or 3-pole connection: See connection possibilities.
- The test key "T" must be pressed every 6 months. The system operator must be informed of this obligation and his responsibility in a way that can be proven (self-adhesive RCD-label enclosed). Under special conditions (e.g. damply and/or dusty environments, environments with polluting and/or corroding conditions, environments with large temperature fluctuations, installations with a risk of overvoltages due to switching of equipment and/or atmospheric discharges, portable equipment ...), it's recommended to test in monthly intervals.
- Pressing the test key "T" serves the only purpose of function testing the residual current device (RCD). This test does not make earthing resistance measurement (R_E), or proper checking of the earth conductor condition redundant, which must be performed separately.
- **Type -A:** Protects against special forms of residual pulsating DC which have not been smoothed.
- **Type -G:** High reliability against unwanted tripping. Compulsory for any circuit where personal injury or damage to property may occur in case of unwanted tripping (ÖVE/ÖNORM E 8001-1 § 12.1.6).
- **Type -G/A:** Additionally protects against special forms of residual pulsating DC which have not been smoothed.
- **Type -R:** To avoid unwanted tripping due to X-ray devices.
- **Type -S:** Selective residual current device sensitive to AC, Type -S. Compulsory for systems with surge arresters downstream of the RCD (ÖVE/ÖNORM E 8001-1 § 12.1.5).
- **Type -S/A:** Additionally protects against special forms of residual pulsating DC which have not been smoothed.
- **Type -U:** Suitable for speed-controlled drives with frequency converters in household, trade, and industry. Unwanted tripping is avoided thanks to a tripping characteristic designed particularly for frequency converters. See also explanation "Frequency Converter-Proof RCDs - What for?" Application according to ÖVE/ÖNORM E 8001-1 and Decision EN 219 (1989), VDE 0100, SEV 1000.

Accessories:

Auxiliary switch for subsequent installation to the left	Z-HK	248432
Tripping signal contact for subsequent installation to the right	Z-NHK	248434
Automatic restarting device	Z-FW/LP	248296
	Z-FW-LPD	265244
Remote control	Z-FW-MO	284730
Pre-mounted sets	Z-FW-LP/MO	290171
	Z-FW-LPD/MO	290172
Remote testing module	Z-FW/003	248298
	Z-FW/010	248299
	Z-FW/030	248300
	Z-FW/050	248301
Terminal cover 4-pole	Z-RC/AK-4TE	101062
Switching interlock	IS/SPE-1TE	101911

Technical Data

	FRCmM
Electrical	
Design according to	IEC/EN 61008 Type G acc. to ÖVE E 8601
Current test marks as printed onto the device	
Tripping	instantaneous
Type G, R	10 ms delay
Type S	40 ms delay - with selective disconnecting function
Type U (only 30 mA)	10 ms delay
Type U (without 30 mA)	40 ms delay - with selective disconnecting function
Rated voltage	U_n 240/415V AC, 50Hz
Limits operation voltage test circuit	
2-pole	196 - 264 V~
4-pole 30 mA	196 - 264 V~
4-pole 100, 300, 500 mA	196 - 456 V~
Rated tripping current	$I_{\Delta n}$ 30, 100, 300, 500 mA
Sensitivity	AC and pulsating DC
Rated insulation voltage	U_i 440 V
Rated impulse withstand voltage	U_{imp} 4 kV (1.2/50 μ s)
Rated short circuit capacity	I_{cn} 10 kA with back-up fuse
Peak withstand current	
Type AC, A	250 A (8/20 μ s) surge current proof
Type G, G/A	3 kA (8/20 μ s) surge current proof, 10 ms delayed
Type S, S/A	5 kA (8/20 μ s) surge current proof, 40 ms delayed
Rated breaking capacity or rated fault breaking capacity	I_m $I_{\Delta m}$
$I_n = 16-40$ A	500 A
$I_n = 63$ A	630 A
$I_n = 80$ A	800 A
$I_n = 100$ A	1,000 A
Endurance	
electrical components	$\geq 4,000$ operating cycles
mechanical components	$\geq 20,000$ operating cycles
Mechanical	
Frame size	45 mm
Device height	80 mm
Device width	35 mm (2MU), 70 mm (4MU)
Mounting	quick fastening with 2 lock-in positions on DIN rail IEC/EN 60715
Degree of protection, built-in	IP40
Degree of protection in moisture-proof enclosure	IP54
Upper and lower terminals	open mouthed/lift terminals
Terminal protection	finger and hand touch safe, BGV A3, ÖVE-EN 6
Terminal capacity	1.5 - 35 mm ² single wire 2 x 16 mm ² multi wire
Terminal screw	M5 (with slotted screw acc. to EN ISO 4757-Z2, Pozidriv PZ2)
Terminal torque	2 - 2.4 Nm
Busbar thickness	0.8 - 2 mm
Operation temperature	-25°C to +40°C
Storage- and transport temperature	-35°C to +60°C
Resistance to climatic conditions	acc. to IEC/EN 61008
Contact position indicator	red / green
Tripping indicator	white / blue

Connection diagram

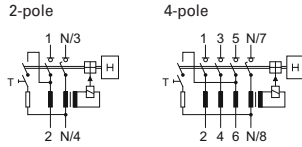

Dimensions (mm)

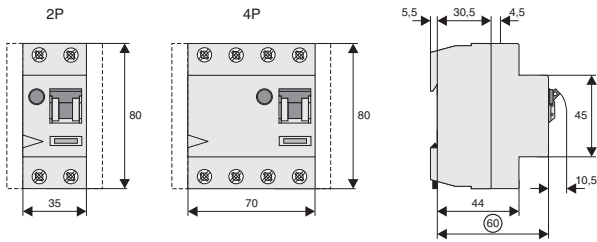

Correct connection

2-pole

30, 100, 300, 500mA Types:

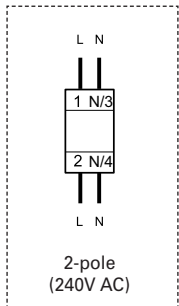

4-pole

30mA Types:

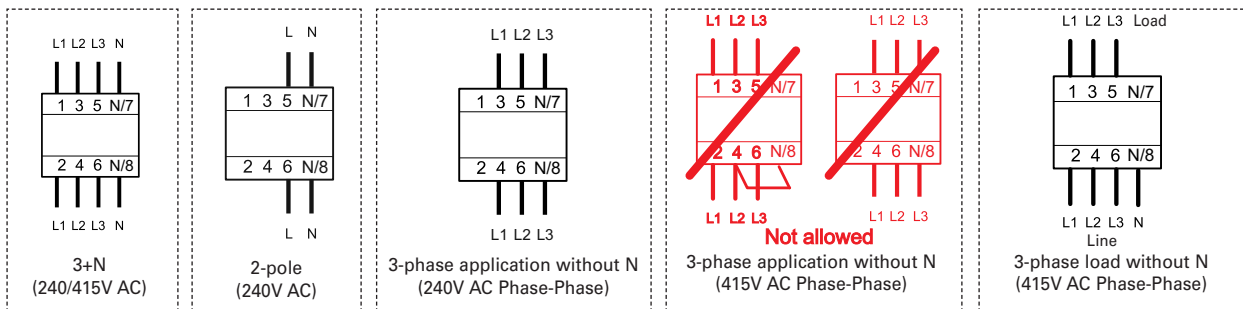

100, 300, 500mA Types:

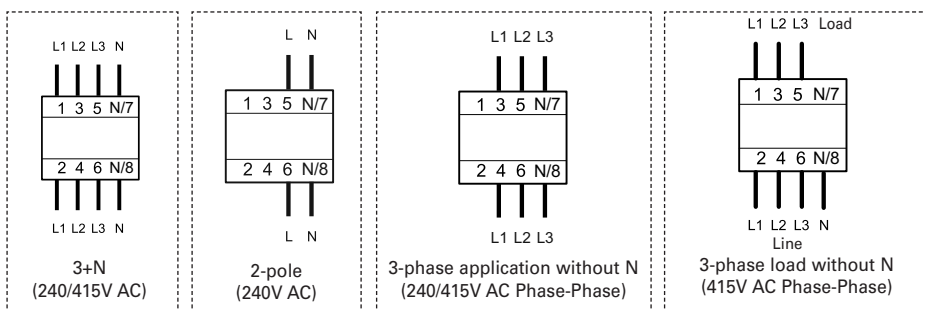

Power Loss at I_n FRCmM

(entire unit)

Sensitivity: AC two-pole

I_n [A]	$I_{\Delta n}$ [mA]	P [W]
16	10	2.9
25	30	2.0
25	100, 300, 500	1.3
40	30	7.8
40	100, 300, 500	5.5
63	30	9.7
63	100, 300, 500	7.2
80	30	13.5
80	100, 300, 500	8.6
100	30, 100, 300	13.6

four-pole

I_n [A]	$I_{\Delta n}$ [mA]	P [W]
25	30	3.1
25	100, 300, 500	2.8
40	30	13.1
40	100, 300, 500	8.8
63	30	13.4
63	100, 300, 500	10.5
80	30, 100, 300, 500	11.4
100	30, 100, 300, 500	18.8

Sensitivity: G, G/A two-pole

I_n [A]	$I_{\Delta n}$ [mA]	P [W]
25	30, 100 (G)	2.0
40	30, 100 (G)	7.8

four-pole

I_n [A]	$I_{\Delta n}$ [mA]	P [W]
40	30 (G)	13.1
40	100 (G, G/A)	8.8
40	30 (G/A)	13.1
63	30 (G)	13.4
63	100 (G, G/A)	10.5
63	30 (G/A)	13.4
100	30, 300 (G/A)	18.8

Sensitivity: R, U four-pole

I_n [A]	$I_{\Delta n}$ [mA]	P [W]
40	100, 300 (U)	8.4
63	30 (R)	13.4
63	100, 300 (U)	10.5
100	300 (U)	18.8

Sensitivity: A two-pole

I_n [A]	$I_{\Delta n}$ [mA]	P [W]
16	10	2.9
16	30	1.2
25	30	2.0
25	100, 300	1.3
40	30	7.8
40	100, 300, 500	5.5
63	30	9.7
63	100, 300, 500	7.2
100	30, 100, 300	13.6

four-pole

I_n [A]	$I_{\Delta n}$ [mA]	P [W]
25	30	3.1
25	100, 300, 500	2.8
40	30	13.1
40	100, 300, 500	8.8
63	30, 100, 300, 500	10.5
80	30, 300	11.4
100	30, 100, 300, 500	18.8

Sensitivity: S, S/A two-pole

I_n [A]	$I_{\Delta n}$ [mA]	P [W]
40	100 (S, S/A)	7.8
40	300 (S)	5.5

four-pole

I_n [A]	$I_{\Delta n}$ [mA]	P [W]
25	100, 300 (S)	2.8
25	100 (S/A)	2.8
40	100, 300 (S, S/A)	8.8
63	100, 300 (S)	10.5
63	100, 300 (S/A)	10.5
80	100, 300 (S)	11.4
80	300 (S/A)	11.4
100	300 (S/A)	18.8

Impact of ambient temperature on the maximum permanent current allowed (A) FRCmM

Ambient temperature	25A		40A		63A		80A		100A	
	2p	4p	2p	4p	2p	4p	2p	4p	2p	4p
40°	25	25	40	40	63	63	80	80	100	100
45°	21	22	37	37	59	59	76	76	95	95
50°	18	19	33	34	55	55	72	72	90	90
55°	14	16	30	31	50	50	68	68	85	85
60°	–	–	26	27	45	45	64	64	80	80
65°	–	–	20	24	40	41	60	60	75	75
70°	–	–	14	19	34	37	56	56	70	70
75°	–	–	8	15	28	32	52	52	65	65

Note: Please make sure that these values are not exceeded and that any upstream thermal overload protection switches off in time.

Max. back-up fuse FRCmM

In [A]	Short Circuit [A]	Overload [A]
25	25 gG/gI	25 gG/gI
40	40 gG/gI	40 gG/gI
63	63 gG/gI	63 gG/gI
80	80 gG/gI	80 gG/gI
100	100 gG/gI	80 gG/gI

Important:

In the case that the maximal possible operating current of the electrical installation don't exceed the rated current of the RCD only short circuit protection must be implemented.

Overload protection must be implemented in the case if the maximal possible operating current of the electrical installation can exceed the rated current of the RCD.

Residual Current Devices FRCmM Type F



sg01616



- Increased protection in applications with 1-phase frequency converter due to the detection of mixed frequencies
- Reduction of nuisance tripping thanks to
 - time delayed tripping
 - increased current withstand capability > 3 kA
- Höhere Belastbarkeit mit glatten Gleichfehlerströmen bis 10 mA
- For fault current/residual current protection and additional protection
- Wide variety of nominal currents
- Comprehensive range of accessories
- Real contact position indicator
- Fault current tripping indicator
- Transparent designation plate

Residual Current Devices FRCmM Type G/F

Surge current-proof 3 kA, sensitive to residual pulsating DC, Type G/F (ÖVE E 8601)  

	$I_n/I_{\Delta n}$ (A)	Type Designation	Article No.	Units per package
2-pole				
	16/0.03	FRCMM-16/2/003-G/F	187365	1/60
	16/0.1	FRCMM-16/2/01-G/F	187371	1/60
	16/0.3	FRCMM-16/2/03-G/F	187377	1/60
	25/0.03	FRCMM-25/2/003-G/F	187366	1/60
	25/0.1	FRCMM-25/2/01-G/F	187372	1/60
	25/0.3	FRCMM-25/2/03-G/F	187378	1/60
	40/0.03	FRCMM-40/2/003-G/F	187367	1/60
	40/0.1	FRCMM-40/2/01-G/F	187373	1/60
	40/0.3	FRCMM-40/2/03-G/F	187379	1/60
	63/0.03	FRCMM-63/2/003-G/F	187368	1/60
	63/0.1	FRCMM-63/2/01-G/F	187374	1/60
	63/0.3	FRCMM-63/2/03-G/F	187380	1/60
	80/0.03	FRCMM-80/2/003-G/F	187369	1/60
	80/0.1	FRCMM-80/2/01-G/F	187375	1/60
	80/0.3	FRCMM-80/2/03-G/F	187381	1/60
	100/0.03	FRCMM-100/2/003-G/F	187370	1/60
	100/0.1	FRCMM-100/2/01-G/F	187376	1/60
100/0.3	FRCMM-100/2/03-G/F	187382	1/60	
4-pole				
	16/0.03	FRCMM-16/4/003-G/F	187407	1/30
	16/0.1	FRCMM-16/4/01-G/F	187413	1/30
	16/0.3	FRCMM-16/4/03-G/F	187419	1/30
	25/0.03	FRCMM-25/4/003-G/F	187408	1/30
	25/0.1	FRCMM-25/4/01-G/F	187414	1/30
	25/0.3	FRCMM-25/4/03-G/F	187420	1/30
	40/0.03	FRCMM-40/4/003-G/F	187409	1/30
	40/0.1	FRCMM-40/4/01-G/F	187415	1/30
	40/0.3	FRCMM-40/4/03-G/F	187421	1/30
	63/0.03	FRCMM-63/4/003-G/F	187410	1/30
	63/0.1	FRCMM-63/4/01-G/F	187416	1/30
	63/0.3	FRCMM-63/4/03-G/F	187422	1/30

Residual Current Devices FRCmM Type S/F

Selective + surge current-proof 5 kA, sensitive to residual pulsating DC, Type S/F  

$I_n/I_{\Delta n}$ (A)	Type Designation	Article No.	Units per package
2-pole			
16/0.1	FRCMM-16/2/01-S/F	187389	1/60
16/0.3	FRCMM-16/2/03-S/F	187395	1/60
25/0.1	FRCMM-25/2/01-S/F	187390	1/60
25/0.3	FRCMM-25/2/03-S/F	187396	1/60
40/0.1	FRCMM-40/2/01-S/F	187391	1/60
40/0.3	FRCMM-40/2/03-S/F	187397	1/60
63/0.1	FRCMM-63/2/01-S/F	187392	1/60
63/0.3	FRCMM-63/2/03-S/F	187398	1/60
80/0.1	FRCMM-80/2/01-S/F	187393	1/60
80/0.3	FRCMM-80/2/03-S/F	187399	1/60
100/0.1	FRCMM-100/2/01-S/F	187394	1/60
100/0.3	FRCMM-100/2/03-S/F	187400	1/60

sg01616



sg01616



4-pole			
16/0.1	FRCMM-16/4/01-S/F	187431	1/30
16/0.3	FRCMM-16/4/03-S/F	187437	1/30
25/0.1	FRCMM-25/4/01-S/F	187432	1/30
25/0.3	FRCMM-25/4/03-S/F	187438	1/30
40/0.1	FRCMM-40/4/01-S/F	187433	1/30
40/0.3	FRCMM-40/4/03-S/F	187439	1/30
63/0.1	FRCMM-63/4/01-S/F	187434	1/30
63/0.3	FRCMM-63/4/03-S/F	187440	1/30

Specifications | Residual Current Devices FRCmM, Type F

Description

- Residual current devices
- Shape compatible with and suitable for standard busbar connection to other devices of the xEffect-series
- Twin-purpose terminal (lift/open-mouthed) above and below
- Busbar positioning optionally above or below
- Free terminal space despite installed busbar
- Universal tripping signal switch, also suitable for FAZ, FRBmM-1N can be mounted subsequently
- Auxiliary switch Z-HK can be mounted subsequently
- Contact position indicator red - green
- Delayed types suitable for being used with standard fluorescent tubes with or without electronic ballast (30mA-RCD: 30 units per phase conductor, 100mA-RCD: 90 units per phase conductor).
Notes: Depending of the fluorescent lamp ballast manufacturer partly more possible. Symmetrical allocation of the fluorescent lamp ballasts on all phases favourably. Shifting references of the fluorescent lamp ballast manufacturer consider.
- The device functions irrespective of the position of installation
- Tripping is line voltage-independent. Consequently, the RCD is suitable for "fault current/residual current protection" and "additional protection" within the meaning of the applicable installation rules.
- Mains connection at either side
- The 4-pole device can also be used for 2- or 3-pole connection: See connection possibilities.
- The test key "T" must be pressed every 6 months. The system operator must be informed of this obligation and his responsibility in a way that can be proven (self-adhesive RCD-label enclosed). Under special conditions (e.g. damply and/or dusty environments, environments with polluting and/or corroding conditions, environments with large temperature fluctuations, installations with a risk of overvoltages due to switching of equipment and/or atmospheric discharges, portable equipment ...), it's recommended to test in monthly intervals.
- Pressing the test key "T" serves the only purpose of function testing the residual current device (RCD). This test does not make earthing resistance measurement (R_E), or proper checking of the earth conductor condition redundant, which must be performed separately.

- **Type -F:** Increased protection in applications with 1-phase frequency, higher load rating with DC residual currents up to 10 mA.

Accessories:

Auxiliary switch for subsequent installation to the left	Z-HK	248432
Tripping signal contact for subsequent installation to the right	Z-NHK	248434
Automatic restarting device	Z-FW/LP	248296
	Z-FW-LPD	265244
Remote control	Z-FW-MO	284730
Pre-mounted sets	Z-FW-LP/MO	290171
	Z-FW-LPD/MO	290172
Remote testing module	Z-FW/003	248298
	Z-FW/010	248299
	Z-FW/030	248300
	Z-FW/050	248301
Terminal cover 2-pole	Z-RC/AK-2TE	285385
Terminal cover 4-pole	Z-RC/AK-4TE	101062
Switching interlock	IS/SPE-1TE	101911

Technical Data

		FRCmM, Type F
Electrical		
Design according to		IEC/EN 62423 Type G acc. to ÖVE E 8601
Current test marks as printed onto the device		
Tripping		
Type G		10 ms delay
Type S		40 ms delay - with selective disconnecting function
Rated voltage	U_n	240/415V AC, 50Hz
Limits operation voltage test circuit		
2-pole		196 - 264 V~
4-pole 30 mA		196 - 264 V~
4-pole 100, 300 mA		196 - 456 V~
Rated tripping current	$I_{\Delta n}$	30, 100, 300 mA
Sensitivity		AC and pulsating DC
Rated insulation voltage	U_i	440 V
Rated impulse withstand voltage	U_{imp}	4 kV (1.2/50 μ s)
Rated short circuit capacity	I_{cn}	10 kA with back-up fuse
Peak withstand current		
Type G/F		3 kA (8/20 μ s) surge current proof, 10 ms delayed
Type S/F		5 kA (8/20 μ s) surge current proof, 40 ms delayed
Rated breaking capacity or rated fault breaking capacity	I_m $I_{\Delta m}$	
$I_n = 16-40$ A		500 A
$I_n = 63$ A		630 A
$I_n = 80$ A		800 A
$I_n = 100$ A		1,000 A
Endurance		
electrical components		$\geq 4,000$ operating cycles
mechanical components		$\geq 20,000$ operating cycles
Mechanical		
Frame size		45 mm
Device height		80 mm
Device width		35 mm (2MU), 70 mm (4MU)
Mounting		quick fastening with 2 lock-in positions on DIN rail IEC/EN 60715
Degree of protection, built-in		IP40
Degree of protection in moisture-proof enclosure		IP54
Upper and lower terminals		open mouthed/lift terminals
Terminal protection		finger and hand touch safe, BGV A3, ÖVE-EN 6
Terminal capacity		1.5 - 35 mm ² single wire 2 x 16 mm ² multi wire
Terminal screw		M5 (with slotted screw acc. to EN ISO 4757-Z2, Pozidriv PZ2)
Terminal torque		2 - 2.4 Nm
Busbar thickness		0.8 - 2 mm
Operation temperature		-25°C to +40°C
Storage- and transport temperature		-35°C to +60°C
Resistance to climatic conditions		acc. to IEC/EN 62423
Contact position indicator		red / green
Tripping indicator		white / blue

Connection diagram

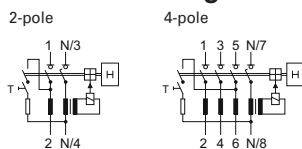

Dimensions (mm)

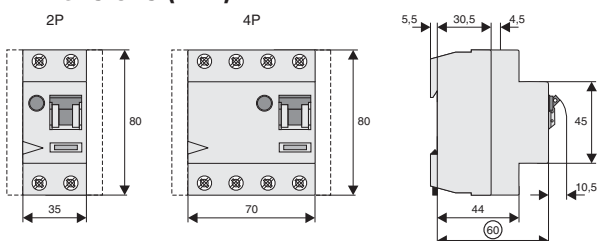

Correct connection

2-pole

30, 100, 300mA Types:

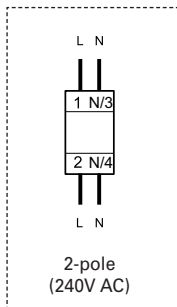

4-pole

30mA Types:

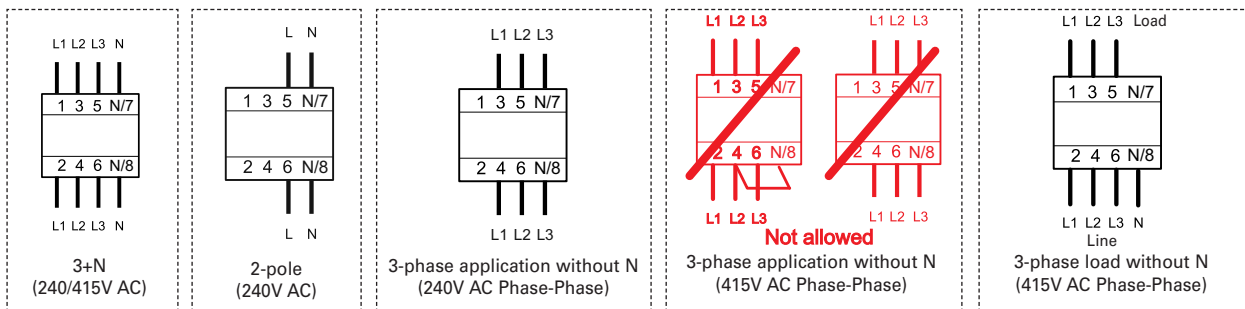

100, 300mA Types:

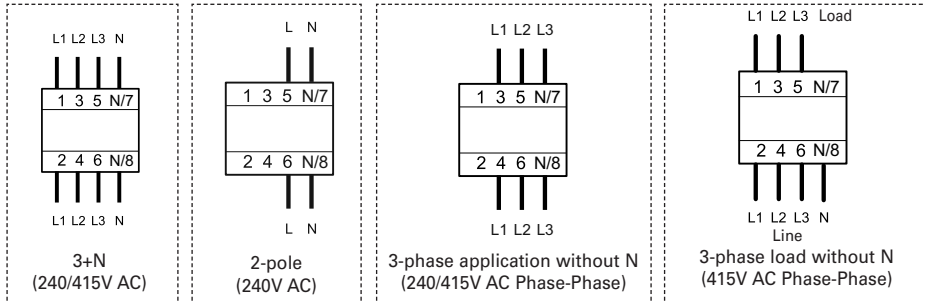

Impact of ambient temperature on the maximum permanent current allowed (A) FRCmM, Type F

Ambient temperature	25A		40A		63A	
	2p	4p	2p	4p	2p	4p
40°	25	25	40	40	63	63
45°	21	22	37	37	59	59
50°	18	19	33	34	55	55
55°	14	16	30	31	50	50
60°	–	–	26	27	45	45
65°	–	–	20	24	40	41
70°	–	–	14	19	34	37
75°	–	–	8	15	28	32

Note: Please make sure that these values are not exceeded and that any upstream thermal overload protection switches off in time.

Max. back-up fuse FRCmM, Type F

In [A]	Short Circuit [A]	Overload [A]
25	63 gG/gI	25 gG/gI
40	63 gG/gI	40 gG/gI
63	63 gG/gI	63 gG/gI

Important:

In the case that the maximal possible operating current of the electrical installation don't exceed the rated current of the RCD only short circuit protection must be implemented.

Overload protection must be implemented in the case if the maximal possible operating current of the electrical installation can exceed the rated current of the RCD.

Residual Current Devices FRCmM-NA Type A according to UL1053 & IEC/EN 61008



SG49612



- Wide range of compact types of RCDs serving as fault-current and additional protection according to UL1053 & IEC/EN 61008 standards, suitable for worldwide use
- Comprehensive range of accessories
- Real contact position indicator
- Fault current tripping indicator
- Automatic re-setting possible
- Transparent designation plate



Residual Current Devices FRCmM-NA Type A

Conditionally surge current-proof 250 A, sensitive to residual pulsating DC, Type A

	$I_n/I_{\Delta n}$ (A)	Type Designation	Article No.	Units per package
SG48612 	2-pole			
	25/0.03	FRCmM-25/2/003-A-NA	167113	1/60
	25/0.3	FRCmM-25/2/03-A-NA	167116	1/60
	40/0.03	FRCmM-40/2/003-A-NA	167114	1/60
	40/0.3	FRCmM-40/2/03-A-NA	167117	1/60
	63/0.03	FRCmM-63/2/003-A-NA	167115	1/60
	63/0.3	FRCmM-63/2/03-A-NA	167118	1/60
SG49612 	4-pole			
	25/0.03	FRCmM-25/4/003-A-NA	167125	1/30
	25/0.3	FRCmM-25/4/03-A-NA	167104	1/30
	40/0.03	FRCmM-40/4/003-A-NA	167102	1/30
	40/0.3	FRCmM-40/4/03-A-NA	167105	1/30
	63/0.03	FRCmM-63/4/003-A-NA	167103	1/30
	63/0.3	FRCmM-63/4/03-A-NA	167106	1/30

Residual Current Devices FRCmM-NA Type G/A

Surge current-proof 3 kA, sensitive to residual pulsating DC, Type G/A (ÖVE E 8601)

	$I_n/I_{\Delta n}$ (A)	Type Designation	Article No.	Units per package
SG48612 	2-pole			
	25/0.03	FRCmM-25/2/003-G/A-NA	167119	1/60
	25/0.3	FRCmM-25/2/03-G/A-NA	167122	1/60
	40/0.03	FRCmM-40/2/003-G/A-NA	167120	1/60
	40/0.3	FRCmM-40/2/03-G/A-NA	167123	1/60
	63/0.03	FRCmM-63/2/003-G/A-NA	167121	1/60
	63/0.3	FRCmM-63/2/03-G/A-NA	167124	1/60
SG49612 	4-pole			
	25/0.03	FRCmM-25/4/003-G/A-NA	167107	1/30
	25/0.3	FRCmM-25/4/03-G/A-NA	167110	1/30
	40/0.03	FRCmM-40/4/003-G/A-NA	167108	1/30
	40/0.3	FRCmM-40/4/03-G/A-NA	167111	1/30
	63/0.03	FRCmM-63/4/003-G/A-NA	167109	1/30
	63/0.3	FRCmM-63/4/03-G/A-NA	167112	1/30

Specifications | Residual Current Devices FRCmM-NA

Description

- Residual current devices
- Purpose terminal lift above and below
- Universal tripping signal switch, also suitable for FAZ, FRBmM-1N can be mounted subsequently
- Auxiliary switch Z-HK can be mounted subsequently
- Contact position indicator red - green
- Tripping indicator white - blue
- All types suitable for being used with standard fluorescent tubes with or without electrical ballast (30mA-RCD: 30 units per phase conductor, 300mA-RCD: 90 units per phase conductor).
Notes: Depending of the fluorescent lamp ballast manufacturer partly more possible. Symmetrical allocation of the fluorescent lamp ballasts on all phases favourably. Shifting references of the fluorescent lamp ballast manufacturer consider.
- The device functions irrespective of the position of installation
- Tripping is line voltage-independent. Consequently, the RCD is suitable for "fault current/residual current protection" and "additional protection" within the meaning of the applicable installation rules.
- Mains connection at either side
- The 4-pole device can also be used for 2-pole connection: See connection possibilities.
- The test key "T" must be pressed every 6 months. The system operator must be informed of this obligation and his responsibility in a way that can be proven (self-adhesive RCD-label enclosed). Under special conditions (e.g. damply and/or dusty environments, environments with polluting and/or corroding conditions, environments with large temperature fluctuations, installations with a risk of overvoltages due to switching of equipment and/or atmospheric discharges, portable equipment ...), it's recommended to test in monthly intervals.
- Pressing the test key "T" serves the only purpose of function testing the residual current device (RCD). This test does not make earthing resistance measurement (R_E), or proper checking of the earth conductor condition redundant, which must be performed separately.
- **Type -A:** Protects against special forms of residual pulsating DC which have not been smoothed.
- **Type -G/A:** Additionally protects against special forms of residual pulsating DC which have not been smoothed

Accessories:

Auxiliary switch for subsequent installation to the left ^{*)}	Z-HK	248432
Tripping signal contact for subsequent installation to the right	Z-NHK	248434
Automatic restarting device ^{*)}	Z-FW/LP	248296
	Z-FW-LPD	265244
Remote control ^{*)}	Z-FW-MO	284730
Pre-mounted sets ^{*)}	Z-FW-LP/MO	290171
	Z-FW-LPD/MO	290172
Remote testing module ^{*)}	Z-FW/003	248298
	Z-FW/030	248300
Terminal cover 4-pole ^{*)}	Z-RC/AK-4TE	101062
Switching interlock ^{*)}	IS/SPE-1TE	101911

^{*)} without UL certification

Technical Data

FRCmM-NA	
Electrical according to IEC/EN 61008	
Design according to	IEC/EN 61008, ÖVE E 8601
Current test marks as printed onto the device	
Tripping	instantaneous
Type G	10 ms delay at 50 Hz
Rated voltage	U_n 240/415 V; 50/60 Hz
Limits operation voltage test circuit	
2-pole	196 - 264 V~
4-pole 30 mA	196 - 264 V~
4-pole 300 mA	196 - 456 V~
Rated tripping current	$I_{\Delta n}$ 30, 300 mA
Sensitivity	AC and pulsating DC
Rated insulation voltage	U_i 440 V
Rated impulse withstand voltage	U_{imp} 4 kV (1.2/50 μ s)
Rated short circuit capacity	I_{cn} 10 kA with back-up fuse
Peak withstand current	
Type A	250 A (8/20 μ s) surge current proof
Type G/A	3 kA (8/20 μ s) surge current proof, 10 ms delayed
Rated breaking capacity	I_m
or rated fault breaking capacity	$I_{\Delta m}$
$I_n = 25-40A$	500 A
$I_n = 63A$	630 A
Endurance	
electrical components	$\geq 4,000$ operating cycles
mechanical components	$\geq 10,000$ operating cycles
Electrical according to UL1053	
Design according to	UL1053
Current test marks as printed onto the device	
Tripping	instantaneous
Type G	8 ms delay at 60Hz
Limits operation voltage test circuit	
2-pole	196 - 305 V~
4-pole 30 mA	196 - 305 V~
4-pole 300 mA	196 - 528 V~
Rated voltage	U_n 480Y/277 V, 60 Hz
Pick-up current	
30 mA Types	22 mA
300 mA Types	200 mA
Sensitivity	AC and pulsating DC
Overtoltage tested	530 V
Rated impulse withstand voltage	U_{imp} 4 kV (1.2/50 μ s)
Rated short circuit capacity	I_{cn} 5 kA acc. to CSA
Rated breaking capacity	I_m
or rated fault breaking capacity	$I_{\Delta m}$
$I_n = 25-40A$	500 A
$I_n = 63A$	630 A
Endurance	
electrical components	$\geq 4,000$ operating cycles
mechanical components	$\geq 10,000$ operating cycles
Mechanical	
Frame size	45 mm
Device height	80 mm
Device width	35 mm (2MU), 70 mm (4MU)
Mounting	quick fastening with 2 lock-in positions on DIN rail IEC/EN 60715
Degree of protection, built-in	IP40
Degree of protection in moisture-proof enclosure	IP54
Upper and lower terminals	lift terminals
Terminal protection	finger and hand touch safe, BGV A3, ÖVE-EN 6
Terminal capacity	1.5 - 35 mm ² single wire 2 x 16 mm ² multi wire
Terminal screw	M5 (with slotted screw acc. to EN ISO 4757-Z2, Pozidriv PZ2)
Operation temperature	-25°C to +40°C
Storage- and transport temperature	-35°C to +60°C
Resistance to climatic conditions	according to IEC 61008

Humidity	5-95%
Pollution degree	2
Contact position indicator	red / green
Tripping indicator	white / blue

Connection diagram

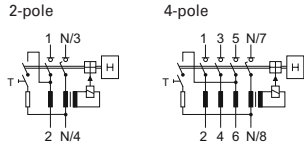

Dimensions (mm)

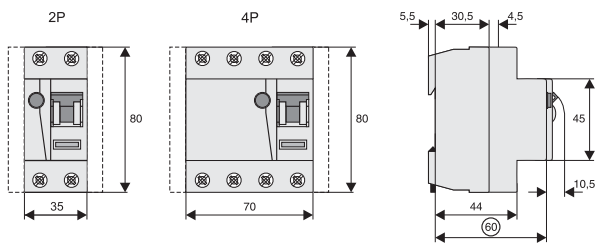

Correct connection

2-pole acc. to IEC61008/UL1053

30, 300mA Types:

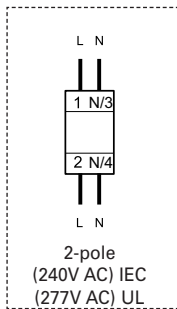

4-pole acc. to IEC61008

30mA Types:

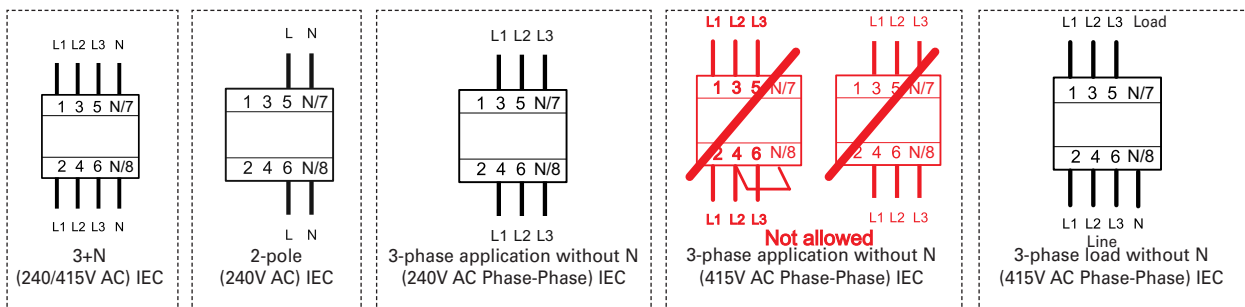

300mA Types:

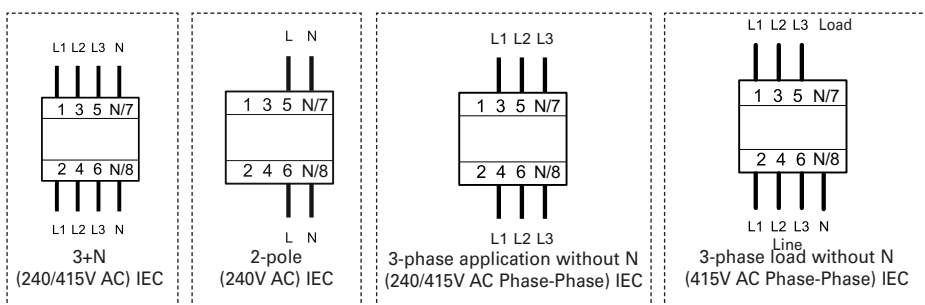

Correct connection

4-pole acc. to UL1053

30, 300mA Types:

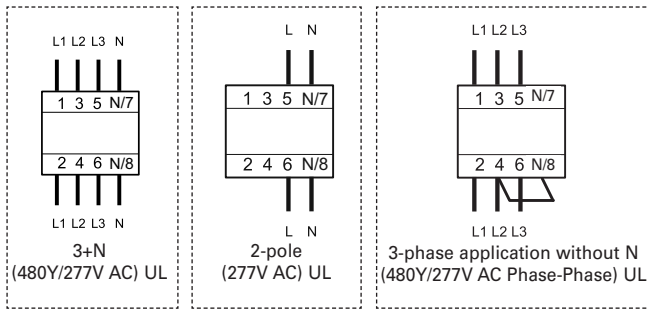

Impact of ambient temperature on the maximum permanent current allowed (A) FRCmM-NA

Ambient temperature	25A		40A		63A	
	2p	4p	2p	4p	2p	4p
40°	25	25	40	40	63	63
45°	21	22	37	37	59	59
50°	18	19	33	34	55	55
55°	14	16	30	31	50	50
60°	–	–	26	27	45	45
65°	–	–	20	24	40	41
70°	–	–	14	19	34	37
75°	–	–	8	15	28	31

Note: Please make sure that these values are not exceeded and that any upstream thermal overload protection switches off in time.

Max. back-up fuse FRCmM-NA (according IEC)

In [A]	Short Circuit [A]	Overload [A]
25	63 gG/gI	25 gG/gI
40	63 gG/gI	40 gG/gI
63	63 gG/gI	40 gG/gI

Important:

In the case that the maximal possible operating current of the electrical installation don't exceed the rated current of the RCD only short circuit protection must be implemented.

Overload protection must be implemented in the case if the maximal possible operating current of the electrical installation can exceed the rated current of the RCD.

Max. back-up fuse FRCmM-NA (according UL)

In [A]	Short Circuit [A]
25-63	70 J-Class Fuse

Important:

The maximal possible operating current of the electrical installation may not exceed the rated current of the RCD (VDE 0100-520 Bbl. 2).

Residual Current Devices FRCmM-NA-110 Type A acc. to UL1053 & IEC/EN 61008

SG49612



- Wide range of compact types of RCDs serving as fault-current and additional protection according to UL1053 & IEC/EN 61008 standards, suitable for worldwide use in the 110 V range of applications
- Comprehensive range of accessories
- Real contact position indicator
- Fault current tripping indicator
- Automatic re-setting possible
- Transparent designation plate

Residual Current Devices FRCmM-NA-110 Type A

Conditionally surge current-proof 250 A, sensitive to residual pulsating DC, Type A 

SG49612



$I_n/I_{\Delta n}$ (A)	Type Designation	Article No.	Units per package
4-pole			
25/0.03	FRCmM-25/4/003-A-NA-110	167699	1/30
25/0.3	FRCmM-25/4/03-A-NA-110	167702	1/30
40/0.03	FRCmM-40/4/003-A-NA-110	167700	1/30
40/0.3	FRCmM-40/4/03-A-NA-110	167703	1/30
63/0.03	FRCmM-63/4/003-A-NA-110	167701	1/30
63/0.3	FRCmM-63/4/03-A-NA-110	167704	1/30

Residual Current Devices FRCmM-NA-110 Type G/A

Surge current-proof 3 kA, sensitive to residual pulsating DC, Type G/A (ÖVE E 8601) 

SG48612



$I_n/I_{\Delta n}$ (A)	Type Designation	Article No.	Units per package
2-pole			
25/0.03	FRCmM-25/2/003-G/A-NA-110	167693	1/60
25/0.3	FRCmM-25/2/03-G/A-NA-110	167696	1/60
40/0.03	FRCmM-40/2/003-G/A-NA-110	167694	1/60
40/0.3	FRCmM-40/2/03-G/A-NA-110	167697	1/60
63/0.03	FRCmM-63/2/003-G/A-NA-110	167695	1/60
63/0.3	FRCmM-63/2/03-G/A-NA-110	167698	1/60

SG49612



$I_n/I_{\Delta n}$ (A)	Type Designation	Article No.	Units per package
4-pole			
25/0.03	FRCmM-25/4/003-G/A-NA-110	167705	1/30
25/0.3	FRCmM-25/4/03-G/A-NA-110	167708	1/30
40/0.03	FRCmM-40/4/003-G/A-NA-110	167706	1/30
40/0.3	FRCmM-40/4/03-G/A-NA-110	167709	1/30
63/0.03	FRCmM-63/4/003-G/A-NA-110	167707	1/30
63/0.3	FRCmM-63/4/03-G/A-NA-110	167710	1/30

Specifications | Residual Current Devices FRCmM-NA-110

Description

- Residual current devices
- Purpose terminal lift above and below
- Universal tripping signal switch, also suitable for FAZ, FRBmM-1N can be mounted subsequently
- Auxiliary switch Z-HK can be mounted subsequently
- Contact position indicator red - green
- Tripping indicator white - blue
- All types suitable for being used with standard fluorescent tubes with or without electrical ballast (30mA-RCD: 30 units per phase conductor, 300mA-RCD: 90 units per phase conductor).
Notes: Depending of the fluorescent lamp ballast manufacturer partly more possible. Symmetrical allocation of the fluorescent lamp ballasts on all phases favourably. Shifting references of the fluorescent lamp ballast manufacturer consider.
- The device functions irrespective of the position of installation
- Tripping is line voltage-independent. Consequently, the RCD is suitable for "fault current/residual current protection" and "additional protection" within the meaning of the applicable installation rules.
- Mains connection at either side
- The 4-pole device can also be used for 2-pole connection:
See connection possibilities.
- The test key "T" must be pressed every 6 months. The system operator must be informed of this obligation and his responsibility in a way that can be proven (self-adhesive RCD-label enclosed). Under special conditions (e.g. damply and/or dusty environments, environments with polluting and/or corroding conditions, environments with large temperature fluctuations, installations with a risk of overvoltages due to switching of equipment and/or atmospheric discharges, portable equipment ...), it's recommended to test in monthly intervals.
- Pressing the test key "T" serves the only purpose of function testing the residual current device (RCD). This test does not make earthing resistance measurement (R_E), or proper checking of the earth conductor condition redundant, which must be performed separately.
- **Type -A:** Protects against special forms of residual pulsating DC which have not been smoothed.
- **Type -G/A:** Additionally protects against special forms of residual pulsating DC which have not been smoothed

Accessories:

Auxiliary switch for subsequent installation to the left ^{*)}	Z-HK	248432
Tripping signal contact for subsequent installation to the right	Z-NHK	248434
Automatic restarting device ^{*)}	Z-FW/LP	248296
	Z-FW-LPD	265244
Remote control ^{*)}	Z-FW-MO	284730
Pre-mounted sets ^{*)}	Z-FW-LP/MO	290171
	Z-FW-LPD/MO	290172
Remote testing module ^{*)}	Z-FW/003	248298
	Z-FW/030	248300
Terminal cover 4-pole ^{*)}	Z-RC/AK-4TE	101062
Switching interlock ^{*)}	IS/SPE-1TE	101911

^{*)} without UL certification

Technical Data

FRCmM-NA-110	
Electrical according to IEC/EN 61008	
Design according to	IEC/EN 61008, ÖVE E 8601
Current test marks as printed onto the device	
Tripping	instantaneous
Type G	10 ms delay at 50Hz
Rated voltage	U_n 110/190 V, 50/60Hz
Limits operation voltage test circuit	
2-pole	94 - 121 V~
4-pole 30 mA	94 - 121 V~
4-pole 300 mA	94 - 210 V~
Rated tripping current	$I_{\Delta n}$ 30, 300 mA
Sensitivity	AC and pulsating DC
Rated insulation voltage	U_i 440 V
Rated impulse withstand voltage	U_{imp} 4 kV (1.2/50 μ s)
Rated short circuit capacity	I_{cn} 10 kA with back-up fuse
Peak withstand current	
Type A	250 A (8/20 μ s) surge current proof
Type G/A	3 kA (8/20 μ s) surge current proof, 10 ms delayed
Rated breaking capacity	I_m
or rated fault breaking capacity	$I_{\Delta m}$
$I_n = 25-40A$	500 A
$I_n = 63A$	630 A
Endurance	
electrical components	$\geq 4,000$ operating cycles
mechanical components	$\geq 10,000$ operating cycles
Electrical according to UL1053	
Design according to	UL1053
Current test marks as printed onto the device	
Tripping	instantaneous
Type G	8 ms delay at 60Hz
Rated voltage	U_n 208/120 V, 60 Hz
Limits operation voltage test circuit	
2-pole	94 - 132 V~
4-poles 30 mA	94 - 132 V~
4-pole 300 mA	94 - 230 V~
Pick-up current	
30 mA Types	22 mA
300 mA Types	200 mA
Sensitivity	AC and pulsating DC
Overtoltage tested	530 V
Rated impulse withstand voltage	U_{imp} 4 kV (1.2/50 μ s)
Rated short circuit capacity	I_{cn} 5 kA acc. to CSA
Rated breaking capacity	I_m
or rated fault breaking capacity	$I_{\Delta m}$
$I_n = 25-40A$	500 A
$I_n = 63A$	630 A
Endurance	
electrical components	$\geq 4,000$ operating cycles
mechanical components	$\geq 10,000$ operating cycles
Mechanical	
Frame size	45 mm
Device height	80 mm
Device width	35 mm (2MU), 70 mm (4MU)
Mounting	quick fastening with 2 lock-in positions on DIN rail IEC/EN 60715
Degree of protection, built-in	IP40
Degree of protection in moisture-proof enclosure	IP54
Upper and lower terminals	lift terminals
Terminal protection	finger and hand touch safe, BGV A3, ÖVE-EN 6
Terminal capacity	1.5 - 35 mm ² single wire 2 x 16 mm ² multi wire
Terminal screw	M5 (with slotted screw acc. to EN ISO 4757-Z2, Pozidriv PZ2)
Operation temperature	-25°C to +40°C
Storage- and transport temperature	-35°C to +60°C
Resistance to climatic conditions	according to IEC 61008

Residual Current Devices

Humidity	5-95%
Pollution degree	2
Contact position indicator	red / green
Tripping indicator	white / blue

Connection diagram

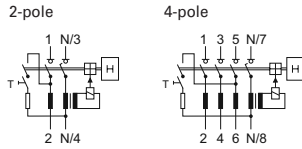

Dimensions (mm)

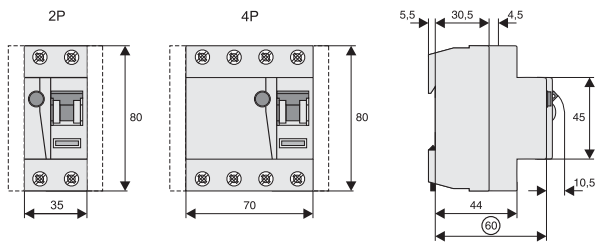

Correct connection

2-pole

30, 300mA Types:

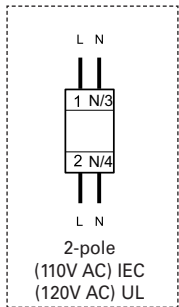

4-pole

30, 300mA Types:

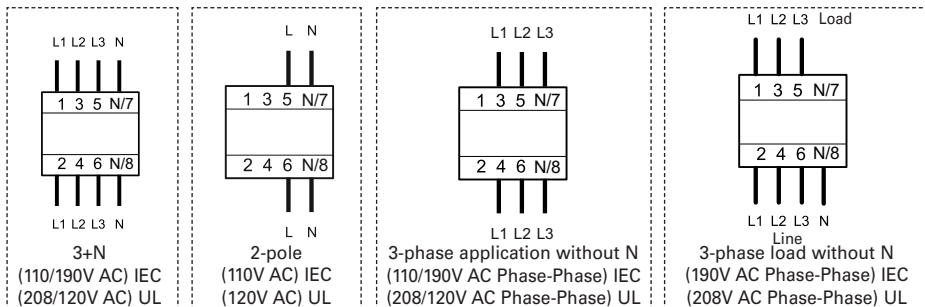

Impact of ambient temperature on the maximum permanent current allowed (A) FRCmM-NA-110

Ambient temperature	25A		40A		63A	
	2p	4p	2p	4p	2p	4p
40°	25	25	40	40	63	63
45°	21	22	37	37	59	59
50°	18	19	33	34	55	55
55°	14	16	30	31	50	50
60°	–	–	26	27	45	45
65°	–	–	20	24	40	41
70°	–	–	14	19	34	37
75°	–	–	8	15	28	31

Note: Please make sure that these values are not exceeded and that any upstream thermal overload protection switches off in time.

Max. back-up fuse FRCmM-NA (according IEC)

In [A]	Short Circuit [A]	Overload [A]
25	63 gG/gI	25 gG/gI
40	63 gG/gI	40 gG/gI
63	63 gG/gI	40 gG/gI

Important:

In the case that the maximal possible operating current of the electrical installation don't exceed the rated current of the RCD only short circuit protection must be implemented.

Overload protection must be implemented in the case if the maximal possible operating current of the electrical installation can exceed the rated current of the RCD.

Max. back-up fuse FRCmM-NA (according UL)

In [A]	Short Circuit [A]
25-63	70 J-Class Fuse

Important:

The maximal possible operating current of the electrical installation may not exceed the rated current of the RCD (VDE 0100-520 Bbl. 2).

Residual Current Devices FRCmM-125 Type A, B, Bfg and B+

SG08013



- Special residual current devices - all fault-current sensitive
- High level of protection against unwanted tripping
- Selective versions available
- Auxiliary switches available
- 30 mA types for operator protection available
- Modern RCB for 125 A rated current
- For fault current/residual current protection and additional protection

Residual Current Devices FRCmM-125 Type A

Conditionally surge current-proof 250 A, sensitive to residual pulsating DC, Type A

	$I_n/I_{\Delta n}$ (A)	Type Designation	Article No.	Units per package
SG07913 	2-pole			
	125/0.03	FRCMM-125/2/003-A	171164	1/60
	125/0.1	FRCMM-125/2/01-A	171165	1/60
	125/0.3	FRCMM-125/2/03-A	171166	1/60
	125/0.5	FRCMM-125/2/05-A	171167	1/60

SG08013 	4-pole			
	125/0.03	FRCMM-125/4/003-A	171174	1/30
	125/0.1	FRCMM-125/4/01-A	171175	1/30
	125/0.3	FRCMM-125/4/03-A	171176	1/30
	125/0.5	FRCMM-125/4/05-A	171177	1/30

Residual Current Devices FRCmM-125 Type G/A

Short-time delayed, surge current-proof 3 kA, sensitive to residual pulsating DC, Type G/A

	$I_n/I_{\Delta n}$ (A)	Type Designation	Article No.	Units per package
SG07913 	2-pole			
	125/0.03	FRCMM-125/2/003-G/A	171168	1/60
	125/0.1	FRCMM-125/2/01-G/A	171169	1/60
	125/0.3	FRCMM-125/2/03-G/A	171170	1/60

SG08013 	4-pole			
	125/0.03	FRCMM-125/4/003-G/A	171178	1/30
	125/0.1	FRCMM-125/4/01-G/A	171179	1/30
	125/0.3	FRCMM-125/4/03-G/A	171180	1/30

Residual Current Devices FRCmM-125 Type S/A

Selective + surge current-proof 5 kA, sensitive to residual pulsating DC, Type S/A 

	$I_n/I_{\Delta n}$ (A)	Type Designation	Article No.	Units per package
	2-pole			
	125/0.1	FRCMM-125/2/01-S/A	171171	1/60
	125/0.3	FRCMM-125/2/03-S/A	171172	1/60
	125/0.5	FRCMM-125/2/05-S/A	171173	1/60

	4-pole			
	125/0.1	FRCMM-125/4/01-S/A	171181	1/30
	125/0.3	FRCMM-125/4/03-S/A	171182	1/30
	125/0.5	FRCMM-125/4/05-S/A	171183	1/30

Residual Current Devices FRCmM-125 Type B

Surge current-proof 3 kA, all-current sensitive, Type B   

	$I_n/I_{\Delta n}$ (A)	Type Designation	Article No.	Units per package
	4-pole			
	125/0.03	FRCMM-125/4/003-B	171184	1/30
	125/0.1	FRCMM-125/4/01-B	171185	1/30
	125/0.3	FRCMM-125/4/03-B	171186	1/30
	125/0.5	FRCMM-125/4/05-B	171187	1/30

Residual Current Devices FRCmM-125 Type G/B

Short-time delayed, surge current-proof 3 kA, all-current sensitive, Type G/B   

	$I_n/I_{\Delta n}$ (A)	Typen- bezeichnung	Artikel-Nr.	VPE (Stk.)
	4-pole			
	125/0.03	FRCMM-125/4/003-G/B	171188	1/30

Residual Current Devices FRCmM-125 Type S/Bfq

Selective + surge current-proof 5 kA, all-current sensitive, Type S/Bfq



	$I_n/I_{\Delta n}$ (A)	Type Designation	Article No.	Units per package
SG08113 	4-pole			
	125/0.3	FRCMM-125/4/03-S/BFQ	171190	1/30
	125/0.5	FRCMM-125/4/05-S/BFQ	171191	1/30

Residual Current Devices FRCmM-125 Type G/B+

Short-time delayed, surge current-proof 3 kA, all-current sensitive, Type G/B+



	$I_n/I_{\Delta n}$ (A)	Type Designation	Article No.	Units per package
SG08113 	4-pole			
	125/0.03	FRCMM-125/4/003-G/B+	171189	1/30

Specifications | Residual Current Devices FRCmM-125, Type A

Description

- Residual current devices
- Tripping is line voltage-independent. Consequently, the RCD is suitable for the protection of humans and additional protection (ÖVE/ÖNORM E 8001-1 § 6.1.2)
- Twin-purpose terminal (lift/open-mouthed) above and below
- Not busbar-compatible with other devices of the xEffect-series
- Auxiliary switch Z-HD can be mounted subsequently
- Contact position indicator red - green
- The device functions irrespective of the position of installation
- Tripping is line voltage-independent. Consequently, the RCD is suitable for "fault current/residual current protection" and "additional protection" within the the meaning of the applicable installation rules
- Mains connection at either side
- The test key "T" must be pressed every 6 months. The system operator must be informed of this obligation and his responsibility in a way that can be proven (self-adhesive RCD-label enclosed). Under special conditions (e.g. damply and/or dusty environments, environments with polluting and/or corroding conditions, environments with large temperature fluctuations, installations with a risk of overvoltages due to switching of equipment and/or atmospheric discharges, portable equipment ...), it's recommended to test in monthly intervals.
- **Type -A:** Additionally protects against special forms of residual pulsating DC which have not been smoothed.
- **Type -G/A:** Additionally protects against special forms of residual pulsating DC which have not been smoothed.
- **Type -S/A:** Compulsory for systems with surge arresters downstream of the RCD (ÖVE/ÖNORM E 8001-1 § 12.1.5).

Accessories:

Auxiliary switch for installation on the left at a later point in time	Z-HD 265620
--	-------------

Technical Data

		FRCmM125A, Type A
Electrical		
Design according to		IEC/EN 61008
Current test marks as printed onto the device		
Tripping		instantaneous
Type G/A		10 ms delay
Type S/A		50 ms delay - with selective disconnecting function
Rated voltage	U_n	240/415 V; 50 Hz
Limits operation voltage test circuit		
30 mA		150 - 250 V~
100, 300, 500 mA		185 - 440 V~
Rated tripping current	$I_{\Delta n}$	30, 100, 300, 500 mA
Sensitivity		AC and pulsating DC
Rated insulation voltage		400 V
Rated impulse withstand voltage		2.5 kV
Rated short circuit strength	I_{nc}	10 kA with back-up fuse
Peak withstand current		
Type A		250 A (8/20 μ s), surge current proof
Type G/A		3 kA (8/20 μ s), surge current proof, 10 ms delayed
Type S/A		5 kA (8/20 μ s), surge current proof, 40 ms delayed
Maximum back-up fuse		Short circuit protection Overload protection
		125 A gG/gL 80 A gG/gL
Rated breaking capacity or Rated fault breaking capacity	I_m $I_{\Delta m}$	1250 A
Endurance		
electrical components		$\geq 4,000$ operating cycles
mechanical components		$\geq 10,000$ operating cycles
Mechanical		
Frame size		45 mm
Device height		80 mm
Device width		36 mm (2P), 72 mm (4P)
Mounting		quick fastening with DIN rail EN50022
Degree of protection, built-in		IP40
Upper and lower terminals		open mouthed/lift terminals
Terminal protection		finger and hand touch safe, BGV A3, ÖVE-EN 6
Terminal capacity		1.5 - 50 mm ²
Busbar thickness		0.8 - 2 mm
Operation temperature		-25°C to +40°C
Storage and transportation temperature range		-25°C to +60°C
Resistance to climatic conditions		25-55°C/90-95% relative humidity acc. to IEC 60068-2
Mounting position		any

Connection diagram

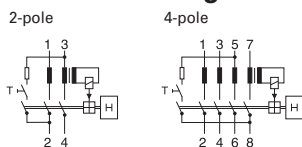

Dimensions (mm)

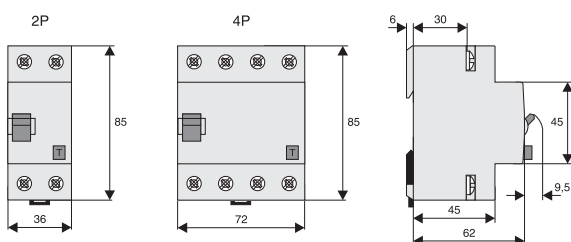

Power Loss at I_n FRCmM-125 - Type A, G/A and S/A

(entire unit)

2-pole		4-pole	
I_n [A]	P [W]	I_n [A]	P [W]
125	18	125	22.5

Specifications | Residual Current Devices FRCmM-125, Type B, Bfg and B+

Description

- Residual current devices - all fault-current sensitive
- Twin-purpose terminal (lift/open-mouthed) above and below
- Busbar positioning optionally above or below
- Free terminal space despite installed busbar
- Not busbar-compatible with other devices of the P series
- Auxiliary switch Z-HD can be mounted at a later point in time
- Contact position indicator red - green
- The device functions irrespective of the position of installation
- Tripping happens independent from line voltage (Type A currents). 50 VAC are required to identify currents of Type B.
- Mains connection is at the top
- The test key "T" must be pressed every half year. The system operator must be informed of this obligation and his responsibility in a way that can be proven (self-adhesive RCD-label enclosed). Under special conditions (e.g. damply and/or dusty environments, environments with polluting and/or corroding conditions, environments with large temperature fluctuations, installations with a risk of over-voltages due to switching of equipment and/or atmospheric discharges, portable equipment ...), it's recommended to test in monthly intervals.
- Pressing the test key "T" serves the only purpose of function testing the residual current device (RCD). This test does not make earthing resistance measurement (R_E), or proper checking of the earth conductor condition redundant, which must be performed separately.
- **Type B:** All fault-current sensitive protective devices are designed for use in 50 Hz AC systems with electrical equipment such as frequency converters, uninterruptible power supply systems, switch mains adapters or highfrequency power converters. In case of a fault, electronic equipment may not only cause AC residual currents and pulsating DC residual currents, but also pure DC and AC residual currents of different frequencies in which case residual current devices of Type AC and A will not trip. Residual current devices of Type FRCmM125A, however, will identify all types of fault currents in line with tripping characteristic B of the IEC 60755 standard, i.e. pure DC residual currents as well. In addition, they will also identify all AC residual currents of all frequencies up to 100 kHz in undulating (mixed) currents.
- **Type Bfg:** Suitable for speed-controlled drives with frequency converters; designed for household, commercial and industrial applications. Unwanted tripping is prevented through a tripping characteristic especially adapted to frequency converters. Protection against all kinds of fault currents.
- **Type B+:** All-current sensitive RCD switchgear for applications where DC fault currents may occur. Non-selective, non-delayed. Protection against all kinds of fault currents. Also meets the requirements of the VDE 0664-400 standard (formerly known as VDE V 0664-110) and therefore provides enhanced fire safety.

Accessories:

Auxiliary switch for installation on the left at a later point in time	Z-HD 265620
--	-------------

Technical Data

FRCmM125A, Type B, Bfg und B+

Electrical

Design according to	IEC/EN 61008	
Current test marks as printed onto the device		
Tripping		
Type B, G/B, G/B+	short-time delayed	
Type S/Bfg	50 ms delay - with selective disconnecting function	
Rated voltage	U_n	240/415 V; 50 Hz
Limits operation voltage test circuit		
30 mA	250 - 440 V~	
100, 300, 500 mA	185 - 440 V~	
Rated tripping current	$I_{\Delta n}$	30, 100, 300, 500 mA
Sensitivity	All types of fault-current	
Rated insulation voltage	400 V	
Rated impulse withstand voltage	2.5 kV	
Rated short circuit capacity	I_{cn}	10 kA with back-up fuse
Peak withstand current		
Type B	3 kA (8/20 μ s), surge current proof	
Type G/B, G/Bfg, G/B+	3 kA (8/20 μ s), surge current proof, 10 ms delayed	
Type S/Bfg	5 kA (8/20 μ s), surge current proof, 40 ms delayed	
Maximum back-up fuse	Short circuit protection	Overload protection
	125 A gG/gL	80 A gG/gL
Rated breaking capacity or rated fault breaking capacity	I_m $I_{\Delta m}$	1250 A
Endurance		
electrical components	$\geq 4,000$ operating cycles	
mechanical components	$\geq 10,000$ operating cycles	
Mechanical		
Frame size	45 mm	
Device height	80 mm	
Device width	70 mm (4MU) for 2-pole and 4-pole	
Mounting	quick fastening with DIN rail EN50022	
Degree of protection, built-in	IP40	
Upper and lower terminals	open mouthed/lift terminals	
Terminal protection	finger and hand touch safe, BGV A3, ÖVE-EN6	
Terminal capacity	1.5 - 50 mm ²	
Busbar thickness	0.8 - 2 mm	
Operation temperature	-25°C to +40°C	
Storage and transportation temperature range	-25°C to +60°C	
Resistance to climatic conditions	25-55°C/90-95% relative humidity acc. to IEC 60068-2	
Mounting position	any	

Connection diagram

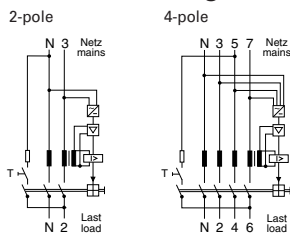

Dimensions (mm)

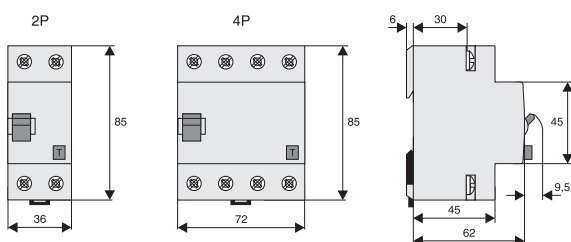

Power Loss at I_n FRCmM-125 - Type B, Bfg und B+

(entire unit)

I_n [A]	P [W]
125	22.5

Tripping current frequency response FRCmM-125

Tripping current frequency response 30 mA Type B

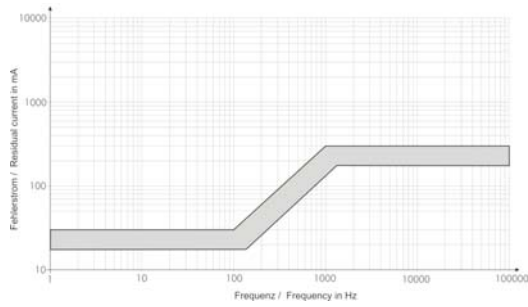

Tripping current frequency response 30 mA Type G/B+

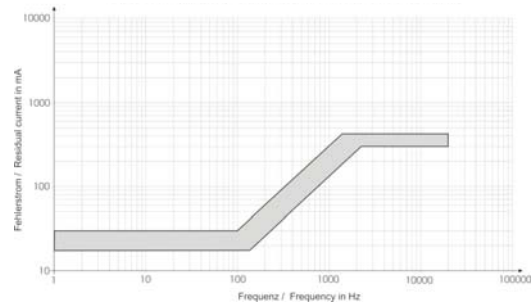

Tripping current frequency response 30 mA Type G/B

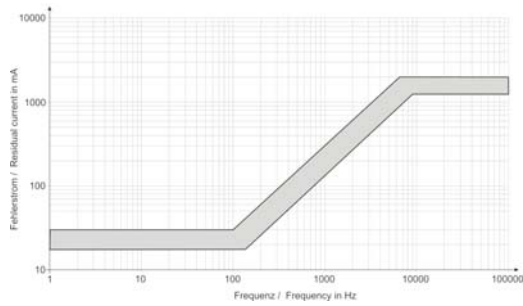

Tripping current frequency response 100 mA Type B

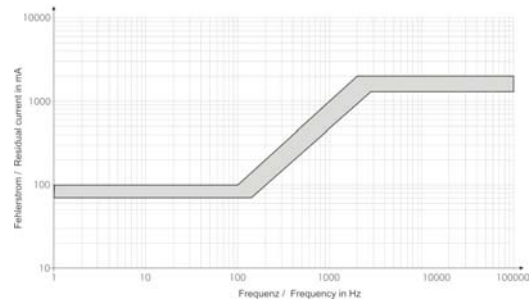

Tripping current frequency response 300 mA Type S/Bfq

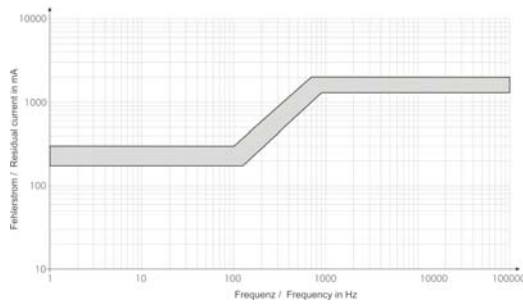

Tripping current frequency response 500 mA Type S/Bfq

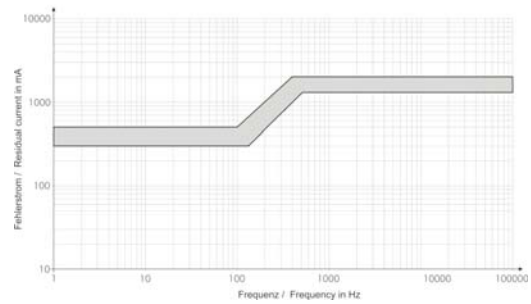

Leakage Current Monitor PDIM

SG31211



- Reliable, universal monitoring of residual current
- RCD characteristic and sensitivity are freely selectable
- Compact design, with integrated transformer
- DIN mounting, compatible with shapes and standard busbar connections of other xEffect devices
- Local status indication of residual current through 3 LEDs
- 2 potential-free signalling contacts

Leakage Current Monitor PDIM

 + , instantaneous, **G**, **S** => adjustable

SG31211



$I_n/I_{\Delta n}$ (A)	Type Designation	Article No.	Units per package
4-pole			
40/0.03; 0.1; 0.3; 0.5; 1	PDIM-40/4	111760	1/30
100/0.03; 0.1; 0.3; 0.5; 1	PDIM-100/4	111761	1/30

Specifications | Leakage Current Monitor PDIM

Description

- Shape compatible with and suitable for standard busbar connection to other devices of the xEffect-series
- Twin-purpose terminal (lift/open-mouthed) above and below
- Busbar positioning optionally above or below
- Free terminal space despite installed busbar
- Power supply via 'OR' disjunction of the 4 conductors
- Electronic functioning (line-voltage dependent)
- The device works irrespective of the position of installation
- Mains connection at either side
- The 4-pole device can also be used for 3-pole connection. For this purpose use terminals 1-2, 3-4, and 5-6.
- The 4-pole device can also be used for 2-pole connection. For this purpose use terminals 5-6 and N-N.
- 2 potential-free relays (make contact, in parallel with the yellow and red LED) (up to 10 A / 240 V~)

Functioning

- The green LED becomes active at 0-30% of the preset $I_{\Delta n}$. The yellow LED becomes active at 30-50% of the preset $I_{\Delta n}$. The red LED becomes active at >50% of the preset $I_{\Delta n}$.
- The yellow LED turns off again when the identified residual current is <30% of the preset $I_{\Delta n}$.
- The red LED stays on even if the identified residual current is <50% of the preset $I_{\Delta n}$.
- The red LED will only turn off after pressing the reset button.
- Only one LED will be active at a time.
- An output relay will always be switched simultaneously with the yellow or red LED
- Depending on the setting of the Type of RCD (instantaneous, G, S), the residual current needs to flow a sufficiently long time before an action is triggered.

Test function

- The rotary coding switch for the RCD switch function is to be set to "TEST". The device then alternately simulates residual currents of 30% and 50% of the $I_{\Delta n}$. In this process, the yellow and red LED flash alternately (1 Hz), both output relays remain permanently energised.

Technical Data

		PDIM	
Electrical			
Design similar to		DIN/EN 62020	
Current test marks as printed onto the device			
Rated current	I_n	40 A, 100 A	
Tripping behaviour (adjustable)		instantaneous	
Type G		10 ms delay	
Type S		40 ms delay - with selective disconnecting function	
Rated voltage	U_n	230/400 V, 50/60 Hz 240/415 V, 50/60 Hz	
Rated tripping current (adjustable)	$I_{\Delta n}$	30, 100, 300, 500, 1000 mA	
Sensitivity		AC and pulsating DC	
Rated insulation voltage	U_i	440 V	
Rated short circuit capacity	I_{cn}	10 kA	
Maximum back-up fuse admitted		Overload protection	Short circuit protection
$I_n = 40A$		40 A gG/gL	63 A gG/gL
$I_n = 100A$		63 A gG/gL	100 A gG/gL
Switching contacts potential-free		10 A / 240 V~	
Tripping behaviour of the contacts		1: 30-50% $I_{\Delta n}$ 2: >50% $I_{\Delta n}$	
Endurance			
electrical components		≥ 4,000 operating cycles	
mechanical components		≥ 20,000 operating cycles	
Mechanical			
Frame size		45 mm	
Device height		80 mm	
Device width		70 mm (4MU)	
Mounting		quick fastening with 2 lock-in positions on DIN rail IEC/EN 60715	
Degree of protection, built-in		IP40	
Degree of protection in splash-proof enclosure		IP54	
Upper and lower terminals		open mouthed/lift terminals	
Terminal protection		Protection against accidental contact according to BGV A3, ÖVE-EN 6	
Terminal capacity (1, 2, 3, 4, 5, 6, N, N)		1.5 - 35 mm ² single-wired 2 x 16 mm ² multi-wired	
Terminal capacity of switching contacts		0.25 - 1.5 mm ²	
Busbar thickness		0.8 - 2 mm	
Operation temperature		-25°C to +40°C	
Storage and transportation temperature range		-35°C to +60°C	
Resistance to climatic conditions		25-55°C/90-95% relative humidity acc. to IEC 60068-2	

Connection diagram

4-pole

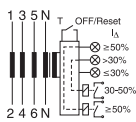

Dimensions (mm)

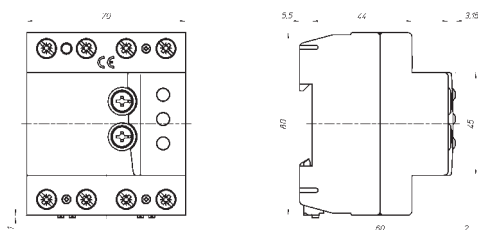

Combined RCD/MCB Devices FRBdM 1+N-, 2-poles Type A Digital

SG05613





- High-quality residual current device / miniature circuit breaker combination, line voltage-dependent
- 1+N and 2-pole
- Contact position indicator red - green
- Tripping indicator white - blue
- New level of accuracy -> reduced unwanted tripping
- Local status indication of residual current through 3 LEDs
- 2-position DIN rail clip, permits removal from existing busbar system
- Comprehensive range of accessories suitable for subsequent installation
- Wide variety of rated tripping currents
- Rated currents up to 25 A
- Tripping characteristics B, C, D
- Rated breaking capacity 10 kA

Combined RCD/MCB Devices FRBdM Type G/A

10 kA, 1+N-pole

Surge current-proof 3 kA, sensitive to residual pulsating DC, Type G/A (ÖVE E 8601)





	$I_n/I_{\Delta n}$ (A)	Type Designation	Article No.	Units per package
Characteristic B				
	10/0.01	FRBdM-B10/1N/001-G/A	168249	1/60
	13/0.01	FRBdM-B13/1N/001-G/A	168250	1/60
	16/0.01	FRBdM-B16/1N/001-G/A	168251	1/60
	10/0.03	FRBdM-B10/1N/003-G/A	168264	1/60
	13/0.03	FRBdM-B13/1N/003-G/A	168265	1/60
	16/0.03	FRBdM-B16/1N/003-G/A	168266	1/60
	10/0.1	FRBdM-B10/1N/01-G/A	168279	1/60
	13/0.1	FRBdM-B13/1N/01-G/A	168280	1/60
16/0.1	FRBdM-B16/1N/01-G/A	168281	1/60	
Characteristic C				
	6/0.01	FRBdM-C6/1N/001-G/A	168252	1/60
	10/0.01	FRBdM-C10/1N/001-G/A	168253	1/60
	13/0.01	FRBdM-C13/1N/001-G/A	168254	1/60
	16/0.01	FRBdM-C16/1N/001-G/A	168255	1/60
	20/0.01	FRBdM-C20/1N/001-G/A	168256	1/60
	25/0.01	FRBdM-C25/1N/001-G/A	168257	1/60
	6/0.03	FRBdM-C6/1N/003-G/A	168267	1/60
	10/0.03	FRBdM-C10/1N/003-G/A	168268	1/60
	13/0.03	FRBdM-C13/1N/003-G/A	168269	1/60
	16/0.03	FRBdM-C16/1N/003-G/A	168270	1/60
	20/0.03	FRBdM-C20/1N/003-G/A	168271	1/60
	25/0.03	FRBdM-C25/1N/003-G/A	168272	1/60
	6/0.1	FRBdM-C6/1N/01-G/A	168282	1/60
	10/0.1	FRBdM-C10/1N/01-G/A	168283	1/60
	13/0.1	FRBdM-C13/1N/01-G/A	168284	1/60
	16/0.1	FRBdM-C16/1N/01-G/A	168285	1/60
	20/0.1	FRBdM-C20/1N/01-G/A	168286	1/60
25/0.1	FRBdM-C25/1N/01-G/A	168287	1/60	
Characteristic D				
	6/0.01	FRBdM-D6/1N/001-G/A	168258	1/60
	10/0.01	FRBdM-D10/1N/001-G/A	168259	1/60
	13/0.01	FRBdM-D13/1N/001-G/A	168260	1/60
	16/0.01	FRBdM-D16/1N/001-G/A	168261	1/60
	20/0.01	FRBdM-D20/1N/001-G/A	168262	1/60
	25/0.01	FRBdM-D25/1N/001-G/A	168263	1/60
	6/0.03	FRBdM-D6/1N/003-G/A	168273	1/60
	10/0.03	FRBdM-D10/1N/003-G/A	168274	1/60
	13/0.03	FRBdM-D13/1N/003-G/A	168275	1/60
	16/0.03	FRBdM-D16/1N/003-G/A	168276	1/60
	20/0.03	FRBdM-D20/1N/003-G/A	168277	1/60
	25/0.03	FRBdM-D25/1N/003-G/A	168278	1/60
	6/0.1	FRBdM-D6/1N/01-G/A	168288	1/60
	10/0.1	FRBdM-D10/1N/01-G/A	168289	1/60
	13/0.1	FRBdM-D13/1N/01-G/A	168290	1/60
	16/0.1	FRBdM-D16/1N/01-G/A	168291	1/60
	20/0.1	FRBdM-D20/1N/01-G/A	168292	1/60
25/0.1	FRBdM-D25/1N/01-G/A	168293	1/60	

Combined RCD/MCB Devices FRBdM Type G/A

10 kA, 2-pole

Surge current-proof 3 kA, sensitive to residual pulsating DC, Type G/A (ÖVE E 8601)



	$I_n/I_{\Delta n}$ (A)	Type Designation	Article No.	Units per package	
Characteristic B					
	10/0.01	FRBdM-B10/2/001-G/A	168294	1/60	
	13/0.01	FRBdM-B13/2/001-G/A	168295	1/60	
	16/0.01	FRBdM-B16/2/001-G/A	168296	1/60	
	10/0.03	FRBdM-B10/2/003-G/A	168198	1/60	
	13/0.03	FRBdM-B13/2/003-G/A	168199	1/60	
	16/0.03	FRBdM-B16/2/003-G/A	168200	1/60	
	10/0.1	FRBdM-B10/2/01-G/A	168213	1/60	
	13/0.1	FRBdM-B13/2/01-G/A	168214	1/60	
	16/0.1	FRBdM-B16/2/01-G/A	168215	1/60	
Characteristic C					
	6/0.01	FRBdM-C6/2/001-G/A	168297	1/60	
	10/0.01	FRBdM-C10/2/001-G/A	168298	1/60	
	13/0.01	FRBdM-C13/2/001-G/A	168299	1/60	
	16/0.01	FRBdM-C16/2/001-G/A	168300	1/60	
	20/0.01	FRBdM-C20/2/001-G/A	168301	1/60	
	25/0.01	FRBdM-C25/2/001-G/A	168302	1/60	
	6/0.03	FRBdM-C6/2/003-G/A	168201	1/60	
	10/0.03	FRBdM-C10/2/003-G/A	168202	1/60	
	13/0.03	FRBdM-C13/2/003-G/A	168203	1/60	
	16/0.03	FRBdM-C16/2/003-G/A	168204	1/60	
	20/0.03	FRBdM-C20/2/003-G/A	168205	1/60	
	25/0.03	FRBdM-C25/2/003-G/A	168206	1/60	
	6/0.1	FRBdM-C6/2/01-G/A	168216	1/60	
	10/0.1	FRBdM-C10/2/01-G/A	168217	1/60	
	13/0.1	FRBdM-C13/2/01-G/A	168218	1/60	
	16/0.1	FRBdM-C16/2/01-G/A	168219	1/60	
	20/0.1	FRBdM-C20/2/01-G/A	168220	1/60	
	25/0.1	FRBdM-C25/2/01-G/A	168221	1/60	
	Characteristic D				
		6/0.01	FRBdM-D6/2/001-G/A	168303	1/60
		10/0.01	FRBdM-D10/2/001-G/A	168304	1/60
13/0.01		FRBdM-D13/2/001-G/A	168305	1/60	
16/0.01		FRBdM-D16/2/001-G/A	168195	1/60	
20/0.01		FRBdM-D20/2/001-G/A	168196	1/60	
25/0.01		FRBdM-D25/2/001-G/A	168197	1/60	
6/0.03		FRBdM-D6/2/003-G/A	168207	1/60	
10/0.03		FRBdM-D10/2/003-G/A	168208	1/60	
13/0.03		FRBdM-D13/2/003-G/A	168209	1/60	
16/0.03		FRBdM-D16/2/003-G/A	168210	1/60	
20/0.03		FRBdM-D20/2/003-G/A	168211	1/60	
25/0.03		FRBdM-D25/2/003-G/A	168212	1/60	
6/0.1		FRBdM-D6/2/01-G/A	168222	1/60	
10/0.1		FRBdM-D10/2/01-G/A	168223	1/60	
13/0.1		FRBdM-D13/2/01-G/A	168224	1/60	
16/0.1		FRBdM-D16/2/01-G/A	168225	1/60	
20/0.1		FRBdM-D20/2/01-G/A	168226	1/60	
25/0.1		FRBdM-D25/2/01-G/A	168227	1/60	

Specifications | Combined RCD/MCB Devices FRBdM, digital

Description

- Combined RCD/MCB device
- Line voltage-dependent tripping
- Compatible with standard busbar
- Twin-purpose terminal (lift/open-mouthed) above and below
- Busbar positioning optionally above or below
- Free terminal space despite installed busbar
- Guide for secure terminal connection
- Contact position indicator red - green
- Fault current tripping indicator white - blue
- Comprehensive range of accessories suitable for subsequent installation
- The test key "T" must be pressed every year. The system operator must be informed of this obligation and his responsibility in a way that can be proven. Under special conditions (e.g. damply and/or dusty environments, environments with polluting and/or corroding conditions, environments with large temperature fluctuations, installations with a risk of overvoltages due to switching of equipment and/or atmospheric discharges, portable equipment ...), it's recommended to test in monthly intervals.
- Pressing the test key "T" serves the only purpose of function testing the residual current device (RCD). This test does not make earthing resistance measurement (R_E), or proper checking of the earth conductor condition redundant, which must be performed separately.
- **Type -G/A:** Additionally protects against special forms of residual pulsating DC which have not been smoothed.
- **Type -G:** High reliability against unwanted tripping. Compulsory for any circuit where personal injury or damage to property may occur in case of unwanted tripping (ÖVE/ÖNORM E 8001-1 § 12.1.6). Additionally protects against special forms of residual pulsating DC which have not been smoothed.

Accessories:

Auxiliary switch for subsequent installation	ZP-IHK	286052
	ZP-WHK	286053
	ZP-NHK	248437
Shunt trip release	ZP-ASA/..	248438, 248439
Switching interlock	IS/SPE-1TE	101911
Screws lock 2MU	Z-CV/SO-2P	221954800

Local Indication RCD

Self check (power ON) 2 s ->

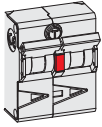
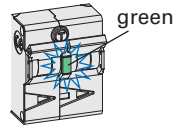

red

$$I_{\Delta} \geq 50\% I_{\Delta n}$$

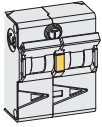

amber

$$I_{\Delta} = 30-50\% I_{\Delta n}$$

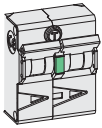

green

$$I_{\Delta} \leq 30\% I_{\Delta n}$$

Service Mode (measuring of residual current I_{Δ})

Pressing test button twice to activate Service-Mode

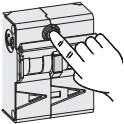

press
(0.1 - 0.4 s)

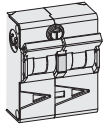

release
(0.1 - 0.4 s)

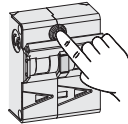

press
(0.1 - 0.4 s)

Measurement delimiter	red
Measurement delimiter ON time	400 ms
10 mA measurement color	amber
1 mA measurement color	green
Double-pressing test button to activate Service Mode	press (0.1-0.4 s) -> release (0.1-0.4 s) -> press (0.1-0.4 s)
Time duration of Service Mode	4 min (during activated Service Mode all protection functions are still working)

Lamp test

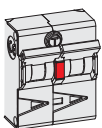

red

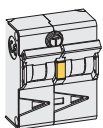

amber

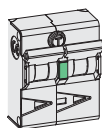

green

2 s ->

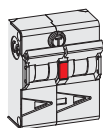

red

100 mA

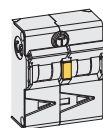

amber

10 mA



amber

10 mA

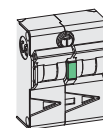

green

1 mA

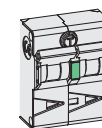

green

1 mA

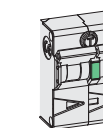

green

1 mA

2 s ->

123 mA

Technical Data

		FRBdM
Electrical		
Design according to		IEC/EN 61009
Current test marks as printed onto the device		
Number of protected poles		
1+N-pole		1
2-pole		2
Tripping		
Type G		line voltage-dependent, 10 ms delay 3 kA (8/20μs), surge current-proof
Rated voltage	U_n	240 V AC, 50 Hz
Rated operational voltage	U_e	204-260 V AC
Voltage range test circuit		195-264 V AC
Rated tripping current	$I_{\Delta n}$	10, 30, 100 mA
Rated non-tripping current	$I_{\Delta no}$	0.55 $I_{\Delta n}$
Sensitivity		G/A
Press of test button duration		> 0.5 s
Selectivity class		3
Service short circuit capacity	I_{cs}	7.5 kA
Rated short circuit capacity	I_{cn}	10 kA
Rated current		6 - 25 A
Rated impulse withstand voltage	U_{imp}	4 kV (1.2/50μs)
Characteristic		B, C, D
Maximum back-up fuse (short circuit)		100 A gL (>10 kA)
Endurance		
electrical components		≥ 4,000 operating cycles ($I_n, U_n, \cos\varphi = 0.87$)
mechanical components		≥ 10,000 operating cycles
Mechanical		
Frame size		45 mm
Device height		80 mm
Device width		35 mm (2MU)
Mounting		2-position DIN rail clip, permits removal from existing busbar system
Degree of protection switch		IP20
Degree of protection, built-in		IP40
Upper and lower terminals		open mouthed/lift terminals
Terminal protection		finger and hand touch safe, VBG4, ÖVE-EN 6
Terminal capacity rigid solid/stranded wire		1 - 25 mm ²
Terminal screw		M5 (with slotted screw acc. to EN ISO 4757-Z2, Pozidriv PZ2)
Terminal torque		2 - 2.4 Nm
Busbar thickness		0.8 - 2 mm
Operation temperature		-25°C to +40°C
Storage- and transport temperature		-35°C to +60°C
Climatic conditions		acc. to IEC 68-2 (25..55°C / 90..95% RH)
Line side (supply)		lower terminals
Load side		upper terminals

Connection diagram

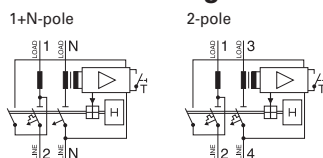

Dimensions (mm)

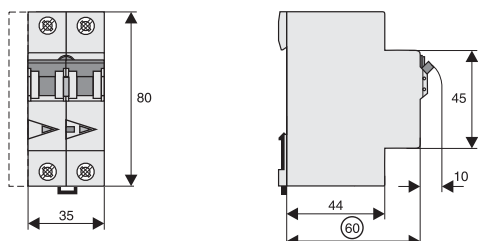

Tripping Characteristic FRBdM, Characteristics B, C and D

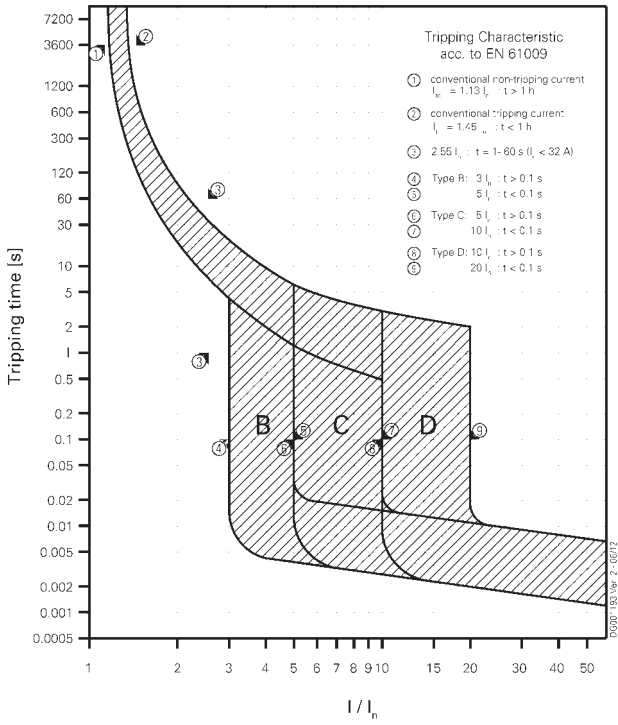

Internal Resistance FRBdM

Type B

At room temperature (single pole)

In [A]	R* [mΩ]
10	17.9
13	12.3
16	7.6

* 50Hz

Type C

At room temperature (single pole)

In [A]	R* [mΩ]
6	28.5
10	17.7
13	9.0
16	6.7
20	5.5
25	3.0

* 50Hz

Type D

At room temperature (single pole)

In [A]	R* [mΩ]
6	28.5
10	14.9
13	9.0
16	6.7
20	5.5
25	3.0

* 50Hz

Power Loss at I_n FRBdM

Type B

(entire unit)

In [A]	P* [W]
10	4.0
13	4.9
16	4.5

* 50Hz and ambient temperature

Type C

(entire unit)

In [A]	P* [W]
6	2.1
10	4.0
13	3.4
16	3.9
20	5.0
25	4.2

* 50Hz and ambient temperature

Type D

(entire unit)

In [A]	P* [W]
6	2.1
10	3.2
13	3.4
16	3.9
20	5.0
25	4.2

* 50Hz and ambient temperature

Let-through Energy FRBdM

Let-through energy FRBdM, characteristic B

240 V

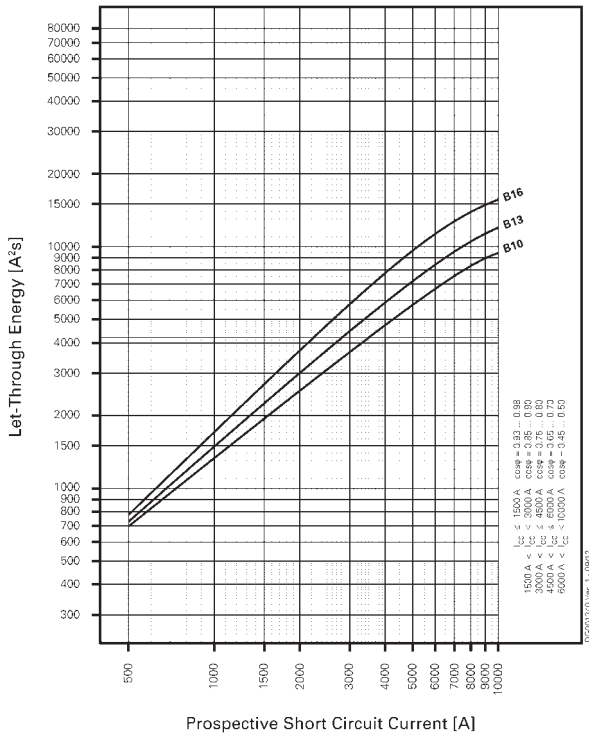

Let-through energy FRBdM, characteristic C

240 V

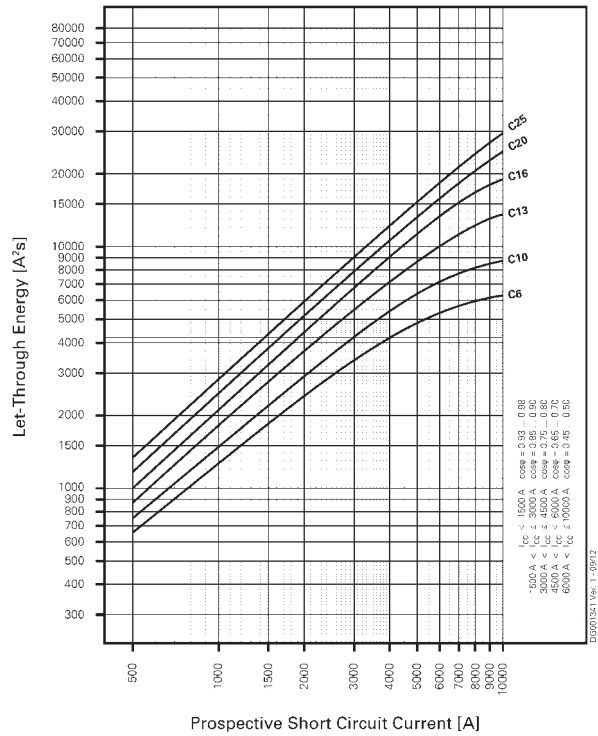

Let-through energy FRBdM, characteristic D

240 V

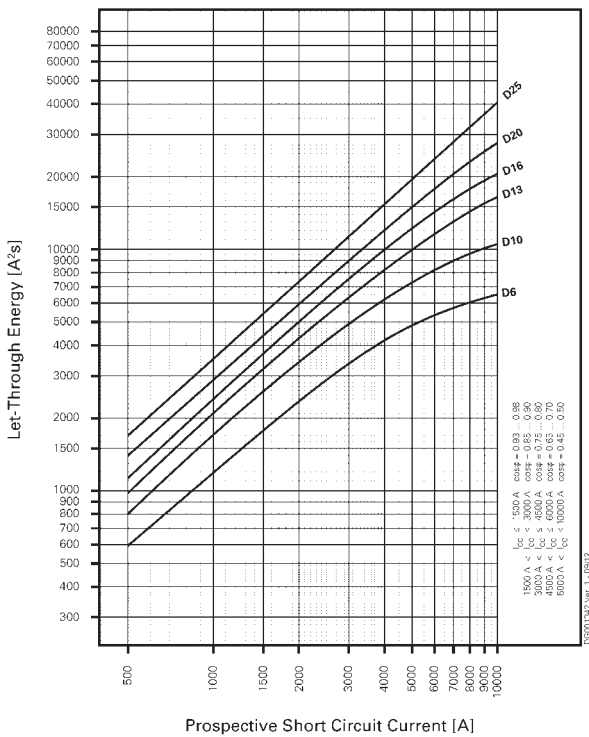

Let-through Current FRBdM

Let-through current FRBdM, characteristic B

240 V

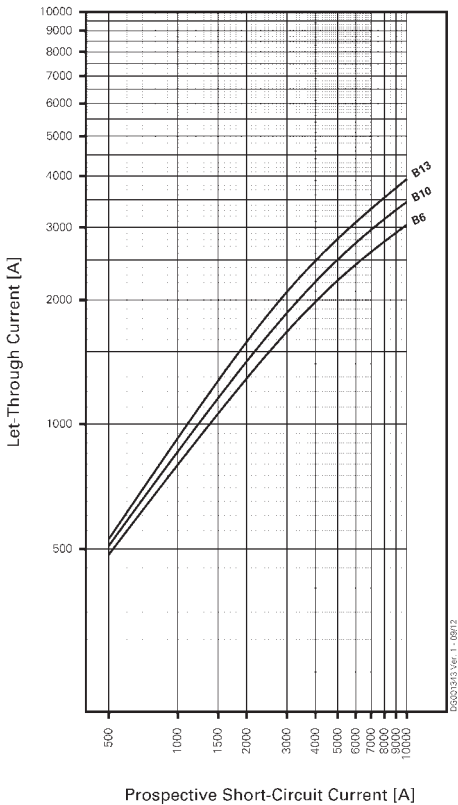

Let-through current FRBdM, characteristic C

240 V

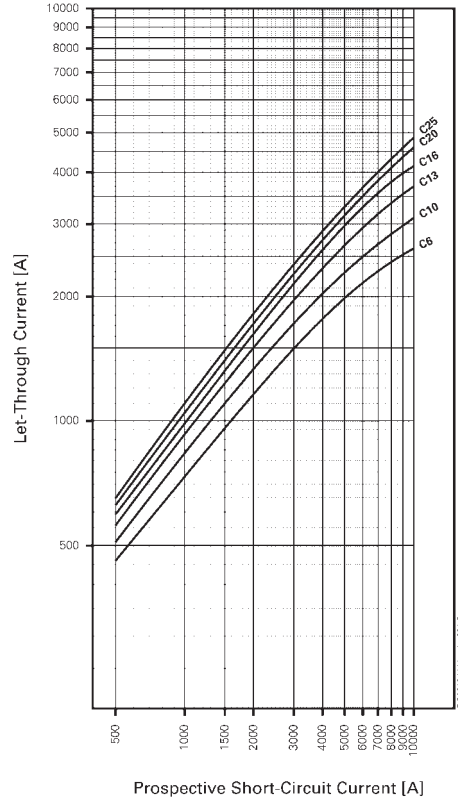

Let-through current FRBdM, characteristic D

240 V

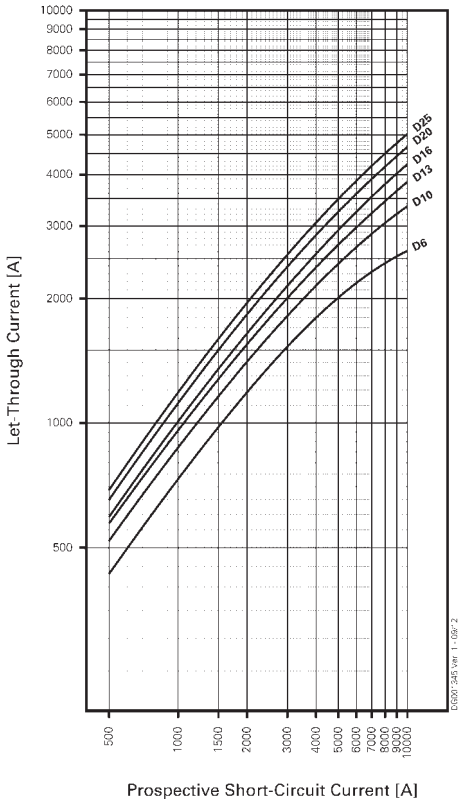

Short-circuit Selectivity FRBdM

In case of a short-circuit, selectivity is provided up to the specified selective current values I_s (kA) applicable between the FRBdM RCD/MCB circuit breakers and the up-stream protective devices.

When a short-circuit occurs, this means that with I_{KS} current values below I_s only the MCB will trip. However, in case of short-circuit currents beyond these values both protective devices will trip.

FRBdM and NZMB(C)(N)(H)1-A..., NZMB(C)(N)(H)2-A...

Short circuit currents in kA, Rated currents of fuses in A.

Overload and short-circuit release unit NZM at max. value

FRBdM	NZM.1-A...						FRBdM	NZM.2-A...								
	$I_{cu} = 25 (36) (50) (100) \text{ kA}$							$I_{cu} = 25 (36) (50) (150) \text{ kA}$								
	40	50	63	80	100	125	40	50	63	80	100	125	160	200	250	
B10	1.2	1.5	2	2	4	10	1	1.5	2.5	3	10	10	10	10	10	
B13	1	1.5	2	2	4	10	1	1.2	2	3	10	10	10	10	10	
B16	1	1.2	1.5	2	3	8	1	1.2	1.5	2.5	10	10	10	10	10	
C+D6	1.2	1.5	2	2	4	10	1	1.5	2.5	3	10	10	10	10	10	
C+D10	1.2	1.5	2	2	4	10	1	1.5	2.5	3	10	10	10	10	10	
C+D13	1	1.5	2	2	4	10	1	1.2	2	3	10	10	10	10	10	
C+D16	1	1.2	1.5	2	3	8	1	1.2	1.5	2.5	10	10	10	10	10	
C+D20	0.8	1.2	1.5	1.5	3	8	1	1.2	1.5	1.5	10	10	10	10	10	
C+D25	0.7	1.1	1.3	1.3	2.5	6	0.9	1.1	1.3	1.3	10	10	10	10	10	

NZMB1(C1)(N1)(H1): $I_{cu} (400/415V) = 25(36)(50)(100) \text{ kA}$ (acc. to IEC/EN 60947-2)

NZMB2(C2)(N2)(H2): $I_{cu} (400/415V) = 25(36)(50)(150) \text{ kA}$ (acc. to IEC/EN 60947-2)

FRBdM and NH000/NH00/NH1 gG

Short circuit currents in kA, Rated currents of fuses in A.

FRBdM	NH000/NH00/NH1 gG											
	16	20	25	32	35	40	50	63	80	100	125	
B10	<0.5	<0.5	0.9	1.7	2.3	3.4	5.2	6.9	>10	>10	>10	
B13	<0.5	<0.5	0.8	1.4	1.9	2.7	4.1	5.2	8.5	>10	>10	
B16	<0.5	<0.5	0.7	1.2	1.6	2.2	3.1	3.8	5.7	>10	>10	
C6	<0.5	0.5	0.9	1.8	2.5	3.8	8.2	>10	>10	>10	>10	
C10	<0.5	<0.5	0.8	1.5	2.0	2.9	4.5	6.6	>10	>10	>10	
C13	<0.5	<0.5	0.6	1.2	1.5	2.2	3.3	4.2	6.7	>10	>10	
C16	<0.5	<0.5	0.6	1.0	1.3	1.8	2.6	3.3	4.8	>10	>10	
C20	<0.5	<0.5	0.5	0.9	1.1	1.6	2.3	2.8	4.1	8.6	>10	
C25	<0.5	<0.5	<0.5	0.8	1.0	1.4	2.0	2.5	3.6	7.1	>10	
D6	<0.5	0.5	1.0	1.8	2.5	3.8	7.8	>10	>10	>10	>10	
D10	<0.5	<0.5	0.7	1.2	1.6	2.4	3.8	5.2	>10	>10	>10	
D13	<0.5	<0.5	0.6	1.0	1.3	1.9	2.8	3.6	5.6	>10	>10	
D16	<0.5	<0.5	0.5	0.9	1.1	1.6	2.3	2.9	4.3	>10	>10	
D20	<0.5	<0.5	<0.5	0.8	1.0	1.4	2.0	2.5	3.6	7.5	>10	
D25	<0.5	<0.5	<0.5	0.7	0.8	1.1	1.6	2.1	3.1	5.5	7.7	

Rated breaking capacity (NH) AC 500 V = 120 kA (acc. to IEC/EN 60269)

FRBdM and PLSM-OV/PLHT-OV...

Short circuit currents in kA, Rated currents of fuses in A.

FRBdM	PLSM-OV/PLHT-OV						
	$I_{cu} = 10 \text{ kA}$						
	25	32	40	50	56	63	80
B10	1.5	1.5	1.5	1.5	1.5	1.5	1.5
B13	1.5	1.5	1.5	1.5	1.5	1.5	1.5
B16	1.5	1.5	1.5	1.5	1.5	1.5	1.5
C+D6	1.5	1.5	1.5	1.5	1.5	1.5	1.5
C+D10	1.5	1.5	1.5	1.5	1.5	1.5	1.5
C+D13	1.5	1.5	1.5	1.5	1.5	1.5	1.5
C+D16	1.5	1.5	1.5	1.5	1.5	1.5	1.5
C+D20	-	1.5	1.5	1.5	1.5	1.5	1.5
C+D25	-	-	1.5	1.5	1.5	1.5	1.5

Back-up Protection FRBdM

The up-stream protective devices will protect the down-stream FRBdM up to the short-circuit current specified.

FRBdM and NZM1.1-A..., 240 V

Short circuit currents in kA.

FRBdM	NZMB1-A...		
	U _e = 240 V		
	B	C	D
6	-	25	25
10	25	25	25
13	25	25	25
16	25	25	25
20	-	20	20
25	-	20	20

U_e = 240V: I_{cn} (FRBdM) = 10 kA (acc. to IEC/EN 61009)
 U_e = 400/415V: I_{cu} (NZMB1) = 25 kA (acc. to IEC/EN 60947-2)

Short circuit currents in kA.

FRBdM	NZMN1-A...		
	U _e = 240 V		
	B	C	D
6	-	40	40
10	40	40	40
13	40	40	40
16	40	40	40
20	-	20	20
25	-	20	20

U_e = 240V: I_{cn} (FRBdM) = 10 kA (acc. to IEC/EN 61009)
 U_e = 400/415V: I_{cu} (NZMN1) = 50 kA (acc. to IEC/EN 60947-2)

Short circuit currents in kA.

FRBdM	NZMC1-A...		
	U _e = 240 V		
	B	C	D
6	-	36	36
10	36	36	36
13	36	36	36
16	36	36	36
20	-	20	20
25	-	20	20

U_e = 240V: I_{cn} (FRBdM) = 10 kA (acc. to IEC/EN 61009)
 U_e = 400/415V: I_{cu} (NZMC1) = 36 kA (acc. to IEC/EN 60947-2)

Short circuit currents in kA.

FRBdM	NZMH1-A...		
	U _e = 240 V		
	B	C	D
6	-	40	40
10	40	40	40
13	40	40	40
16	40	40	40
20	-	20	20
25	-	20	20

U_e = 240V: I_{cn} (FRBdM) = 10 kA (acc. to IEC/EN 61009)
 U_e = 400/415V: I_{cu} (NZMH1) = 100 kA (acc. to IEC/EN 60947-2)

FRBdM and NZM2-A..., 240 V

Short circuit currents in kA.

FRBdM	NZMB2-A...		
	U _e = 240 V		
	B	C	D
6	-	25	25
10	25	25	25
13	25	25	25
16	25	25	25
20	-	20	20
25	-	10	10

U_e = 240V: I_{cn} (FRBdM) = 10 kA (acc. to IEC/EN 61009)
 U_e = 400/415V: I_{cu} (NZMB2) = 25 kA (acc. to IEC/EN 60947-2)

Short circuit currents in kA.

FRBdM	NZMN1-A...		
	U _e = 240 V		
	B	C	D
6	-	40	40
10	40	40	40
13	40	40	40
16	25	25	25
20	-	15	15
25	-	10	10

U_e = 240V: I_{cn} (FRBdM) = 10 kA (acc. to IEC/EN 61009)
 U_e = 400/415V: I_{cu} (NZMN2) = 50 kA (acc. to IEC/EN 60947-2)

Short circuit currents in kA.

FRBdM	NZMC1-A...		
	U _e = 240 V		
	B	C	D
6	-	36	36
10	36	36	36
13	36	36	36
16	25	25	25
20	-	20	20
25	-	10	10

U_e = 240V: I_{cn} (FRBdM) = 10 kA (acc. to IEC/EN 61009)
 U_e = 400/415V: I_{cu} (NZMC2) = 36 kA (acc. to IEC/EN 60947-2)

Short circuit currents in kA.

FRBdM	NZMH1-A...		
	U _e = 240 V		
	B	C	D
6	-	40	40
10	40	40	40
13	40	40	40
16	25	25	25
20	-	15	15
25	-	10	10

U_e = 240V: I_{cn} (FRBdM) = 10 kA (acc. to IEC/EN 61009)
 U_e = 400/415V: I_{cu} (NZMH2) = 150 kA (acc. to IEC/EN 60947-2)

FRBdM and NH00-125 A, 240 V

Short circuit currents in kA.

FRBdM	NH00-125A gG		
	U _e = 240 V		
	B	C	D
6	-	40	40
10	40	40	40
13	40	40	40
16	40	40	40
20	-	20	20
25	-	10	10

U_e = 240V: I_{cn} (FRBdM) = 10 kA (acc. to IEC/EN 61009)
 AC 500 V (NH00-125A gG) = 120 kA (acc. to IEC/EN 60269)

FRBdM and PLSM-OV63, 230 V

Short circuit currents in kA.

FRBdM	PLSM-OV63/2,3,4,3N		
	IT-System U = 230 V		
	B	C	D
6	-	10	10
10	10	10	10
13	10	10	10
16	10	10	10
20	-	10	10
25	-	10	10

U_e = 240V: I_{cn} (FRBdM) = 10 kA (acc. to IEC/EN 61009)
 U_e = 230/400V: I_{cu} (PLSM-OV63) = 10 kA (acc. to IEC/EN 60947-2)

Combined RCD/MCB Devices FRBmM, 1+N-pole

SG03013



- High-quality residual current device / miniature circuit breaker combination, line voltage-independent
- Contact position indicator red - green
- Fault current tripping indicator
- Guide for secure terminal connection
- 3-position DIN rail clip, permits removal from existing busbar system
- Comprehensive range of accessories suitable for subsequent installation
- Wide variety of rated tripping currents
- Rated currents up to 40 A
- Tripping characteristics B, C, D
- Rated breaking capacity 10 kA

Combined RCD/MCB Devices FRBmM Type AC

10 kA, 1+N-pole

Conditionally surge current-proof 250 A, Type AC



SG03013



$I_n/I_{\Delta n}$ (A)	Type Designation	Article No.	Units per package
Characteristic B			
6/0.01	FRBmM-B6/1N/001	170971	1/60
10/0.01	FRBmM-B10/1N/001	170972	1/60
13/0.01	FRBmM-B13/1N/001	170973	1/60
16/0.01	FRBmM-B16/1N/001	170974	1/60
6/0.03	FRBmM-B6/1N/003	170920	1/60
10/0.03	FRBmM-B10/1N/003	170695	1/60
13/0.03	FRBmM-B13/1N/003	170696	1/60
16/0.03	FRBmM-B16/1N/003	170697	1/60
20/0.03	FRBmM-B20/1N/003	170698	1/60
25/0.03	FRBmM-B25/1N/003	170699	1/60
32/0.03	FRBmM-B32/1N/003	170700	1/60
40/0.03	FRBmM-B40/1N/003	170701	1/60
6/0.1	FRBmM-B6/1N/01	170656	1/60
10/0.1	FRBmM-B10/1N/01	170657	1/60
13/0.1	FRBmM-B13/1N/01	170658	1/60
16/0.1	FRBmM-B16/1N/01	170659	1/60
20/0.1	FRBmM-B20/1N/01	170660	1/60
25/0.1	FRBmM-B25/1N/01	170661	1/60
32/0.1	FRBmM-B32/1N/01	170662	1/60
40/0.1	FRBmM-B40/1N/01	170663	1/60
6/0.3	FRBmM-B6/1N/03	170551	1/60
10/0.3	FRBmM-B10/1N/03	170600	1/60
13/0.3	FRBmM-B13/1N/03	170601	1/60
16/0.3	FRBmM-B16/1N/03	170602	1/60
20/0.3	FRBmM-B20/1N/03	170603	1/60
25/0.3	FRBmM-B25/1N/03	170604	1/60
32/0.3	FRBmM-B32/1N/03	170605	1/60
40/0.3	FRBmM-B40/1N/03	170606	1/60

SG03013



$I_n/I_{\Delta n}$ (A)	Type Designation	Article No.	Units per package
Characteristic C			
2/0.01	FRBmM-C2/1N/001	170979	1/60
4/0.01	FRBmM-C4/1N/001	170980	1/60
6/0.01	FRBmM-C6/1N/001	170981	1/60
10/0.01	FRBmM-C10/1N/001	170982	1/60
13/0.01	FRBmM-C13/1N/001	170983	1/60
16/0.01	FRBmM-C16/1N/001	170984	1/60
2/0.03	FRBmM-C2/1N/003	170532	1/60
4/0.03	FRBmM-C4/1N/003	170533	1/60
6/0.03	FRBmM-C6/1N/003	170534	1/60
10/0.03	FRBmM-C10/1N/003	170535	1/60
13/0.03	FRBmM-C13/1N/003	170536	1/60
16/0.03	FRBmM-C16/1N/003	170537	1/60
20/0.03	FRBmM-C20/1N/003	170538	1/60
25/0.03	FRBmM-C25/1N/003	170539	1/60
32/0.03	FRBmM-C32/1N/003	170612	1/60
40/0.03	FRBmM-C40/1N/003	170613	1/60
2/0.1	FRBmM-C2/1N/01	170672	1/60
4/0.1	FRBmM-C4/1N/01	170673	1/60
6/0.1	FRBmM-C6/1N/01	170674	1/60
10/0.1	FRBmM-C10/1N/01	170675	1/60
13/0.1	FRBmM-C13/1N/01	170676	1/60
16/0.1	FRBmM-C16/1N/01	170677	1/60
20/0.1	FRBmM-C20/1N/01	170678	1/60
25/0.1	FRBmM-C25/1N/01	170679	1/60
32/0.1	FRBmM-C32/1N/01	170680	1/60
40/0.1	FRBmM-C40/1N/01	170681	1/60
2/0.3	FRBmM-C2/1N/03	170561	1/60
4/0.3	FRBmM-C4/1N/03	170562	1/60
6/0.3	FRBmM-C6/1N/03	170563	1/60
10/0.3	FRBmM-C10/1N/03	170564	1/60
13/0.3	FRBmM-C13/1N/03	170565	1/60
16/0.3	FRBmM-C16/1N/03	170566	1/60
20/0.3	FRBmM-C20/1N/03	170567	1/60
25/0.3	FRBmM-C25/1N/03	170568	1/60
32/0.3	FRBmM-C32/1N/03	170569	1/60
40/0.3	FRBmM-C40/1N/03	170570	1/60

SG03013



Characteristic D

2/0.01	FRBmM-D2/1N/001	170922	1/60
4/0.01	FRBmM-D4/1N/001	170909	1/60
6/0.01	FRBmM-D6/1N/001	170910	1/60
10/0.01	FRBmM-D10/1N/001	170911	1/60
13/0.01	FRBmM-D13/1N/001	170912	1/60
16/0.01	FRBmM-D16/1N/001	170913	1/60
2/0.03	FRBmM-D2/1N/003	170636	1/60
4/0.03	FRBmM-D4/1N/003	170637	1/60
6/0.03	FRBmM-D6/1N/003	170638	1/60
10/0.03	FRBmM-D10/1N/003	170639	1/60
13/0.03	FRBmM-D13/1N/003	170640	1/60
16/0.03	FRBmM-D16/1N/003	170641	1/60
20/0.03	FRBmM-D20/1N/003	170642	1/60
2/0.1	FRBmM-D2/1N/01	170692	1/60
4/0.1	FRBmM-D4/1N/01	170693	1/60
6/0.1	FRBmM-D6/1N/01	170694	1/60
10/0.1	FRBmM-D10/1N/01	170540	1/60
13/0.1	FRBmM-D13/1N/01	170541	1/60
16/0.1	FRBmM-D16/1N/01	170542	1/60
20/0.1	FRBmM-D20/1N/01	170543	1/60
2/0.3	FRBmM-D2/1N/03	170587	1/60
4/0.3	FRBmM-D4/1N/03	170588	1/60
6/0.3	FRBmM-D6/1N/03	170589	1/60
10/0.3	FRBmM-D10/1N/03	170590	1/60
13/0.3	FRBmM-D13/1N/03	170591	1/60
16/0.3	FRBmM-D16/1N/03	170592	1/60
20/0.3	FRBmM-D20/1N/03	170593	1/60

Combined RCD/MCB Devices FRBmM Type A

10 kA, 1+N-pole

Conditionally surge current-proof 250 A, sensitive to residual pulsating DC, Type A 

SG03013



$I_n/I_{\Delta n}$
(A)

Type
Designation

Article No.

Units
per
package

Characteristic B

6/0.01	FRBmM-B6/1N/001-A	170975	1/60
10/0.01	FRBmM-B10/1N/001-A	170976	1/60
13/0.01	FRBmM-B13/1N/001-A	170977	1/60
16/0.01	FRBmM-B16/1N/001-A	170978	1/60
6/0.03	FRBmM-B6/1N/003-A	170702	1/60
10/0.03	FRBmM-B10/1N/003-A	170703	1/60
13/0.03	FRBmM-B13/1N/003-A	170704	1/60
16/0.03	FRBmM-B16/1N/003-A	170705	1/60
20/0.03	FRBmM-B20/1N/003-A	170706	1/60
25/0.03	FRBmM-B25/1N/003-A	170707	1/60
32/0.03	FRBmM-B32/1N/003-A	170708	1/60
40/0.03	FRBmM-B40/1N/003-A	170709	1/60
6/0.1	FRBmM-B6/1N/01-A	170664	1/60
10/0.1	FRBmM-B10/1N/01-A	170665	1/60
13/0.1	FRBmM-B13/1N/01-A	170666	1/60
16/0.1	FRBmM-B16/1N/01-A	170667	1/60
20/0.1	FRBmM-B20/1N/01-A	170668	1/60
25/0.1	FRBmM-B25/1N/01-A	170669	1/60
32/0.1	FRBmM-B32/1N/01-A	170670	1/60
40/0.1	FRBmM-B40/1N/01-A	170671	1/60
6/0.3	FRBmM-B6/1N/03-A	170607	1/60
10/0.3	FRBmM-B10/1N/03-A	170608	1/60
13/0.3	FRBmM-B13/1N/03-A	170609	1/60
16/0.3	FRBmM-B16/1N/03-A	170610	1/60
20/0.3	FRBmM-B20/1N/03-A	170611	1/60
25/0.3	FRBmM-B25/1N/03-A	170552	1/60
32/0.3	FRBmM-B32/1N/03-A	170553	1/60
40/0.3	FRBmM-B40/1N/03-A	170554	1/60

SG03013



Characteristic C

2/0.01	FRBmM-C2/1N/001-A	170904	1/60
4/0.01	FRBmM-C4/1N/001-A	170905	1/60
6/0.01	FRBmM-C6/1N/001-A	170906	1/60
10/0.01	FRBmM-C10/1N/001-A	170907	1/60
13/0.01	FRBmM-C13/1N/001-A	170908	1/60
16/0.01	FRBmM-C16/1N/001-A	170921	1/60
2/0.03	FRBmM-C2/1N/003-A	170614	1/60
4/0.03	FRBmM-C4/1N/003-A	170615	1/60
6/0.03	FRBmM-C6/1N/003-A	170616	1/60
10/0.03	FRBmM-C10/1N/003-A	170617	1/60
13/0.03	FRBmM-C13/1N/003-A	170618	1/60
16/0.03	FRBmM-C16/1N/003-A	170619	1/60
20/0.03	FRBmM-C20/1N/003-A	170620	1/60
25/0.03	FRBmM-C25/1N/003-A	170621	1/60
32/0.03	FRBmM-C32/1N/003-A	170622	1/60
40/0.03	FRBmM-C40/1N/003-A	170623	1/60
2/0.1	FRBmM-C2/1N/01-A	170682	1/60
4/0.1	FRBmM-C4/1N/01-A	170683	1/60
6/0.1	FRBmM-C6/1N/01-A	170684	1/60
10/0.1	FRBmM-C10/1N/01-A	170685	1/60
13/0.1	FRBmM-C13/1N/01-A	170686	1/60
16/0.1	FRBmM-C16/1N/01-A	170687	1/60
20/0.1	FRBmM-C20/1N/01-A	170688	1/60
25/0.1	FRBmM-C25/1N/01-A	170689	1/60
32/0.1	FRBmM-C32/1N/01-A	170690	1/60
40/0.1	FRBmM-C40/1N/01-A	170691	1/60
2/0.3	FRBmM-C2/1N/03-A	170571	1/60
4/0.3	FRBmM-C4/1N/03-A	170572	1/60
6/0.3	FRBmM-C6/1N/03-A	170573	1/60
10/0.3	FRBmM-C10/1N/03-A	170574	1/60
13/0.3	FRBmM-C13/1N/03-A	170575	1/60
16/0.3	FRBmM-C16/1N/03-A	170576	1/60
20/0.3	FRBmM-C20/1N/03-A	170577	1/60
25/0.3	FRBmM-C25/1N/03-A	170578	1/60
32/0.3	FRBmM-C32/1N/03-A	170579	1/60
40/0.3	FRBmM-C40/1N/03-A	170580	1/60

SG03013



Characteristic D

2/0.01	FRBmM-D2/1N/001-A	170914	1/60
4/0.01	FRBmM-D4/1N/001-A	170915	1/60
6/0.01	FRBmM-D6/1N/001-A	170916	1/60
10/0.01	FRBmM-D10/1N/001-A	170917	1/60
13/0.01	FRBmM-D13/1N/001-A	170918	1/60
16/0.01	FRBmM-D16/1N/001-A	170919	1/60
2/0.03	FRBmM-D2/1N/003-A	170643	1/60
4/0.03	FRBmM-D4/1N/003-A	170644	1/60
6/0.03	FRBmM-D6/1N/003-A	170645	1/60
10/0.03	FRBmM-D10/1N/003-A	170646	1/60
13/0.03	FRBmM-D13/1N/003-A	170647	1/60
16/0.03	FRBmM-D16/1N/003-A	170648	1/60
20/0.03	FRBmM-D20/1N/003-A	170649	1/60
2/0.1	FRBmM-D2/1N/01-A	170544	1/60
4/0.1	FRBmM-D4/1N/01-A	170545	1/60
6/0.1	FRBmM-D6/1N/01-A	170546	1/60
10/0.1	FRBmM-D10/1N/01-A	170547	1/60
13/0.1	FRBmM-D13/1N/01-A	170548	1/60
16/0.1	FRBmM-D16/1N/01-A	170549	1/60
20/0.1	FRBmM-D20/1N/01-A	170550	1/60
2/0.3	FRBmM-D2/1N/03-A	170594	1/60
4/0.3	FRBmM-D4/1N/03-A	170595	1/60
6/0.3	FRBmM-D6/1N/03-A	170596	1/60
10/0.3	FRBmM-D10/1N/03-A	170597	1/60
13/0.3	FRBmM-D13/1N/03-A	170598	1/60
16/0.3	FRBmM-D16/1N/03-A	170599	1/60
20/0.3	FRBmM-D20/1N/03-A	170868	1/60

Combined RCD/MCB Devices FRBmM Type G

10 kA, 1+N-pole

Surge current-proof 3 kA, Type G (ÖVE E 8601) 

SG03013



$I_n/I_{\Delta n}$
(A)

Type
Designation

Article No.

Units
per
package

Characteristic B

13/0.03	FRBmM-B13/1N/003-G	170710	1/60
16/0.03	FRBmM-B16/1N/003-G	170711	1/60
20/0.03	FRBmM-B20/1N/003-G	170712	1/60
25/0.03	FRBmM-B25/1N/003-G	170713	1/60
32/0.03	FRBmM-B32/1N/003-G	170714	1/60
40/0.03	FRBmM-B40/1N/003-G	170715	1/60
13/0.3	FRBmM-B13/1N/03-G	170555	1/60
16/0.3	FRBmM-B16/1N/03-G	170556	1/60
20/0.3	FRBmM-B20/1N/03-G	170557	1/60
25/0.3	FRBmM-B25/1N/03-G	170558	1/60
32/0.3	FRBmM-B32/1N/03-G	170559	1/60
40/0.3	FRBmM-B40/1N/03-G	170560	1/60

SG03013



Characteristic C

13/0.03	FRBmM-C13/1N/003-G	170624	1/60
16/0.03	FRBmM-C16/1N/003-G	170625	1/60
20/0.03	FRBmM-C20/1N/003-G	170626	1/60
25/0.03	FRBmM-C25/1N/003-G	170627	1/60
32/0.03	FRBmM-C32/1N/003-G	170628	1/60
40/0.03	FRBmM-C40/1N/003-G	170629	1/60
13/0.3	FRBmM-C13/1N/03-G	170581	1/60
16/0.3	FRBmM-C16/1N/03-G	170582	1/60
20/0.3	FRBmM-C20/1N/03-G	170583	1/60
25/0.3	FRBmM-C25/1N/03-G	170584	1/60
32/0.3	FRBmM-C32/1N/03-G	170585	1/60
40/0.3	FRBmM-C40/1N/03-G	170586	1/60

SG03013



Characteristic D

13/0.03	FRBmM-D13/1N/003-G	170650	1/60
16/0.03	FRBmM-D16/1N/003-G	170651	1/60
20/0.03	FRBmM-D20/1N/003-G	170652	1/60
13/0.3	FRBmM-D13/1N/03-G	170869	1/60
16/0.3	FRBmM-D16/1N/03-G	170870	1/60
20/0.3	FRBmM-D20/1N/03-G	170871	1/60

Combined RCD/MCB Devices FRBmM Type G/A

10 kA, 1+N-pole

Surge current-proof 3 kA, sensitive to residual pulsating DC, Type G/A (ÖVE E 8601)



	$I_n/I_{\Delta n}$ (A)	Type Designation	Article No.	Units per package
Characteristic B				
	13/0.03	FRBmM-B13/1N/003-G/A	170716	1/60
	16/0.03	FRBmM-B16/1N/003-G/A	170717	1/60
	20/0.03	FRBmM-B20/1N/003-G/A	170528	1/60
	25/0.03	FRBmM-B25/1N/003-G/A	170529	1/60
	32/0.03	FRBmM-B32/1N/003-G/A	170530	1/60
	40/0.03	FRBmM-B40/1N/003-G/A	170531	1/60
Characteristic C				
	13/0.03	FRBmM-C13/1N/003-G/A	170630	1/60
	16/0.03	FRBmM-C16/1N/003-G/A	170631	1/60
	20/0.03	FRBmM-C20/1N/003-G/A	170632	1/60
	25/0.03	FRBmM-C25/1N/003-G/A	170633	1/60
	32/0.03	FRBmM-C32/1N/003-G/A	170634	1/60
	40/0.03	FRBmM-C40/1N/003-G/A	170635	1/60
Characteristic D				
	13/0.03	FRBmM-D13/1N/003-G/A	170653	1/60
	16/0.03	FRBmM-D16/1N/003-G/A	170654	1/60
	20/0.03	FRBmM-D20/1N/003-G/A	170655	1/60

Specifications | Combined RCD/MCB Devices FRBmM, 1+N-pole

Description

- Combined RCD/MCB device
- Line voltage-independent tripping
- Compatible with standard busbar
- Twin-purpose terminal (lift/open-mouthed) above and below
- Busbar positioning optionally above or below
- Free terminal space despite installed busbar
- Guide for secure terminal connection
- Contact position indicator red - green
- Comprehensive range of accessories suitable for subsequent installation
- Nameplate
- The test key "T" must be pressed every 6 months. The system operator must be informed of this obligation and his responsibility in a way that can be proven. Under special conditions (e.g. damply and/or dusty environments, environments with polluting and/or corroding conditions, environments with large temperature fluctuations, installations with a risk of overvoltages due to switching of equipment and/or atmospheric discharges, portable equipment ...), it's recommended to test in monthly intervals.
- Pressing the test key "T" serves the only purpose of function testing the residual current device (RCD). This test does not make earthing resistance measurement (R_E), or proper checking of the earth conductor condition redundant, which must be performed separately.
- **Type -A:** Protects against special forms of residual pulsating DC which have not been smoothed.
- **Type -G:** High reliability against unwanted tripping. Compulsory for any circuit where personal injury or damage to property may occur in case of unwanted tripping (ÖVE/ÖNORM E 8001-1 § 12.1.6).

Accessories:

Auxiliary switch for subsequent installation	ZP-IHK	286052
	ZP-WHK	286053
Tripping signal switch for subsequent installation	ZP-NHK	248437
Shunt trip release	ZP-ASA/..	248438, 248439
Tripping module	Z-KAM	248294
Switching interlock	IS/SPE-1TE	101911
Terminal cover 2-pole	Z-TC/SD-2P	178099

Technical Data

		FRBmM, 1+N-pole
Electrical		
Design according to		IEC/EN 61009
Current test marks as printed onto the device		
Tripping line voltage-independent		instantaneous 250A (8/20 μ s), surge current-proof
Type G		10 ms delay 3kA (8/20 μ s), surge current-proof
Rated voltage	U_n	240V AC, 50Hz
Rated tripping current	$I_{\Delta n}$	10, 30, 100, 300 mA
Rated non-tripping current	$I_{\Delta no}$	0.5 $I_{\Delta n}$
Sensitivity		AC and pulsating DC
Selectivity class		3
Rated breaking capacity	I_{cn}	10 kA
Rated current		2 - 40 A
Rated impulse withstand voltage	U_{imp}	4 kV (1.2/50 μ s)
Characteristic		B, C, D
Maximum back-up fuse (short circuit)		100 A gL (>10 kA)
Endurance		
electrical components		\geq 4,000 operating cycles
mechanical components		\geq 10,000 operating cycles
Mechanical		
Frame size		45 mm
Device height		80 mm
Device width		35 mm (2MU)
Mounting		3-position DIN rail clip, permits removal from existing busbar system
Degree of protection switch		IP20
Degree of protection, built-in		IP40
Upper and lower terminals		open mouthed/lift terminals
Terminal protection		finger and hand touch safe, BGV A3, ÖVE-EN 6
Terminal capacity		1 - 25 mm ²
Terminal torque		2 - 2.4 Nm
Busbar thickness		0.8 - 2 mm
Operation temperature		-25°C to +40°C
Storage- and transport temperature		-35°C to +60°C
Climatic conditions		acc. to IEC 68-2 (25..55°C / 90..95% RH)

Connection diagram

1+N-pole

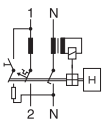

Dimensions (mm)

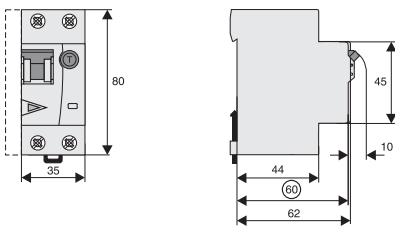

Tripping Characteristic FRBmM-../1N/, Characteristics B, C, and D

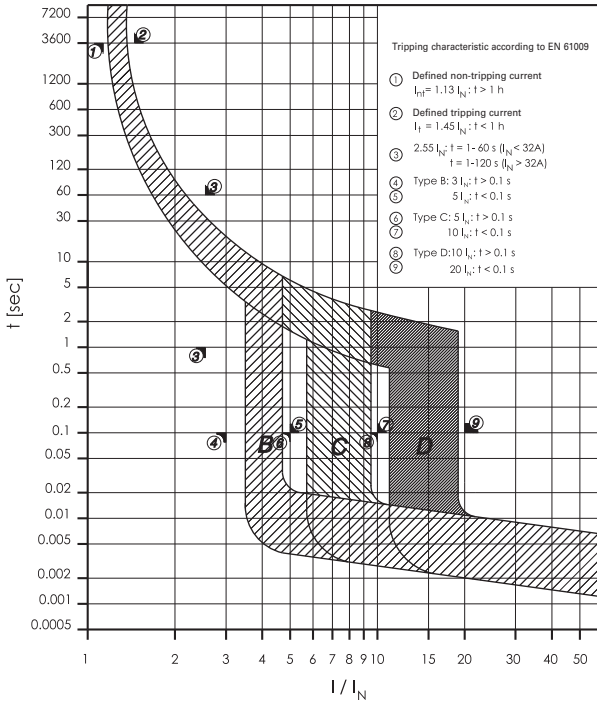

Effect of ambient temperature FRBmM-../1N/

Effect of ambient temperature (MCB component)

I_n [A]	Ambient temperature T [°C]								
	-25	-20	-10	0	10	20	30	35	40
2	2.5	2.4	2.3	2.2	2.2	2.1	2.0	2.0	1.9
4	4.9	4.8	4.7	4.5	4.3	4.2	4.0	3.9	3.9
6	7.4	7.2	7.0	6.7	6.5	6.3	6.0	5.9	5.8
10	12	12	12	11	11	10	10	9.9	9.7
13	16	16	15	15	14	14	13	13	13
16	20	19	19	18	17	17	16	16	15
20	25	24	23	22	22	21	20	20	19
25	31	30	29	28	27	26	25	25	24
32	40	38	37	36	35	33	32	32	31
40	49	48	47	45	43	42	40	39	39

Let-through Energy FRBmM-../1N/

Let-through energy FRBmM, characteristic B, 1+N-pole

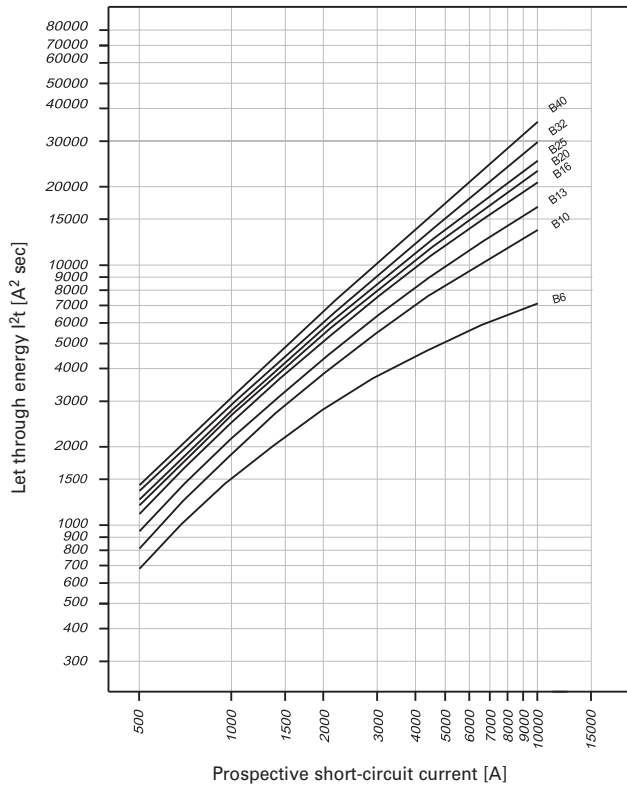

Let-through energy FRBmM, characteristic C, 1+N-pole

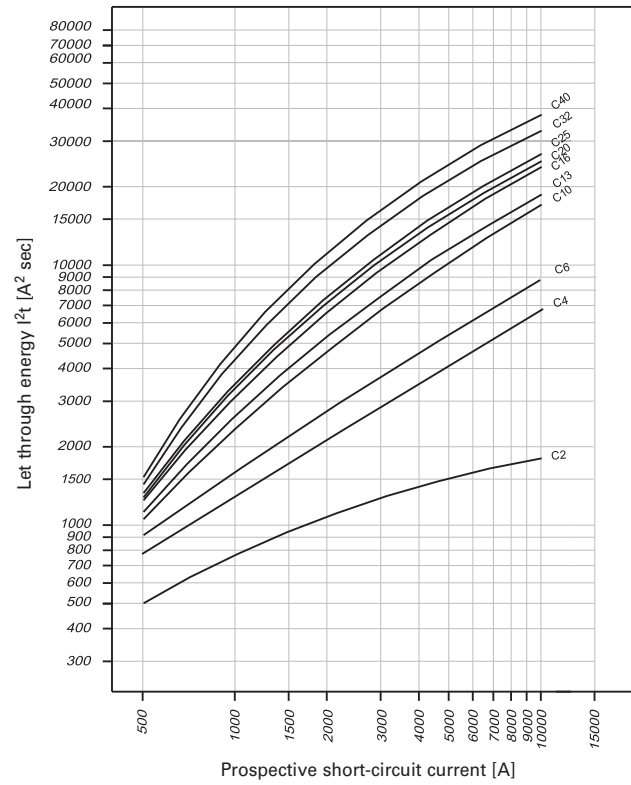

Let-through energy FRBmM, characteristic D, 1+N-pole

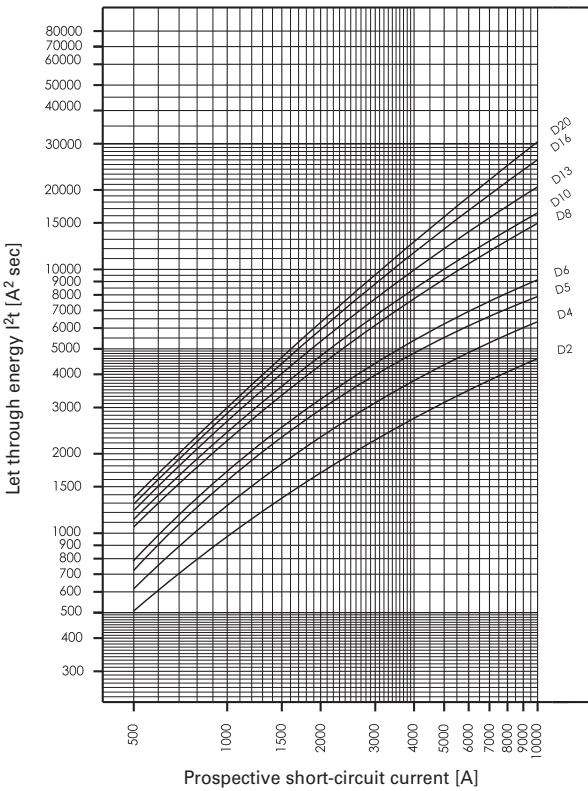

Short-circuit Selectivity FRBmM-../1N/

In case of a short-circuit, selectivity is provided up to the specified selective current values I_s (kA) applicable between the FRBmM RCD/MCB circuit breakers and the up-stream protective devices.

When a short-circuit occurs, this means that with I_{KS} current values below I_s only the MCB will trip. However, in case of short-circuit currents beyond these values both protective devices will trip.

FRBmM-../1N/ and DII-DIV fuse link

Short circuit selectivity **characteristic B** towards fuse link **DII-DIV***)

FRBmM	DII-DIV gL/gG									
	I_n [A]	10	16	20	25	35	50	63	80	100
6		<0.5 ¹⁾	0.7	1.0	2.9	6.9	10.0 ²⁾	10.0 ²⁾	10.0 ²⁾	10.0 ²⁾
10			0.6	0.9	1.9	3.3	7.0	10.0 ²⁾	10.0 ²⁾	10.0 ²⁾
13			0.5	0.7	1.6	2.8	5.7	9.0	10.0 ²⁾	10.0 ²⁾
16				0.7	1.4	2.4	4.4	7.0	10.0 ²⁾	10.0 ²⁾
20					1.3	2.2	4.0	6.3	10.0 ²⁾	10.0 ²⁾
25					1.3	2.1	3.8	5.8	10.0 ²⁾	10.0 ²⁾
32						2.0	3.5	5.2	9.5	10.0 ²⁾
40							3.1	4.5	8.1	10.0 ²⁾

Short circuit selectivity **characteristic C** towards fuse link **DII-DIV***)

FRBmM	DII-DIV gL/gG									
	I_n [A]	10	16	20	25	35	50	63	80	100
2		<0.5 ¹⁾	<0.5 ¹⁾	1.7	6.0	10.0 ²⁾	10.0 ²⁾	10.0 ²⁾	10.0 ²⁾	10.0 ²⁾
4		<0.5 ¹⁾	<0.5 ¹⁾	0.7	1.3	4.2	8.5	10.0 ²⁾	10.0 ²⁾	10.0 ²⁾
6			<0.5 ¹⁾	0.6	1.0	2.9	5.8	10.0 ²⁾	10.0 ²⁾	10.0 ²⁾
10				<0.5	0.7	1.5	2.6	5.3	9.0	10.0 ²⁾
13						1.4	2.3	4.6	7.6	10.0 ²⁾
16						1.2	1.8	3.4	5.5	10.0 ²⁾
20						1.2	1.7	3.1	5.0	10.0 ²⁾
25							1.6	2.9	4.6	10.0 ²⁾
32								2.3	3.4	7.7
40									2.9	6.2

¹⁾ Selectivity limit current I_s under 0.5 kA

²⁾ Selectivity limit current I_s = rated breaking capacity I_{cn} of the RCD/MCB device
Darker areas: no selectivity

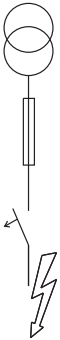

Short circuit selectivity **characteristic D** towards fuse link **DII-DIV***)

FRBmM	DII-DIV gL/gG									
	I_n [A]	10	16	20	25	35	50	63	80	100
2		<0.5 ¹⁾	<0.5 ¹⁾	1.0	1.8	6.5	10.0 ²⁾	10.0 ²⁾	10.0 ²⁾	10.0 ²⁾
4			<0.5 ¹⁾	0.8	1.3	3.8	9.0	10.0 ²⁾	10.0 ²⁾	10.0 ²⁾
6				0.6	0.9	2.3	4.7	10.0 ²⁾	10.0 ²⁾	10.0 ²⁾
10					0.7	1.5	2.6	5.5	9.4	10.0 ²⁾
13						1.4	2.2	4.4	7.0	10.0 ²⁾
16							2.0	3.7	5.5	10.0 ²⁾
20								1.9	3.4	5.0

FRBmM-../1N/ and D01-D03 fuse link

Short circuit selectivity **characteristic B** towards fuse link **D01-D03***)

FRBmM	D01-D03 gL/gG									
	I _n [A]	10	16	20	25	35	50	63	80	100
6		<0.5 ¹⁾	0.5	0.8	2.4	8.2	10.0 ²⁾	10.0 ²⁾	10.0 ²⁾	10.0 ²⁾
10			0.5	0.8	1.6	3.7	6.0	10.0 ²⁾	10.0 ²⁾	10.0 ²⁾
13			0.6	0.7	1.4	3.0	4.7	9.0	10.0 ²⁾	10.0 ²⁾
16				0.6	1.2	2.6	3.9	7.0	10.0 ²⁾	10.0 ²⁾
20					1.2	2.5	3.6	6.2	10.0 ²⁾	10.0 ²⁾
25					1.2	2.3	3.3	5.7	10.0 ²⁾	10.0 ²⁾
32						2.3	3.1	5.1	10.0 ²⁾	10.0 ²⁾
40							2.8	4.5	9.5	10.0 ²⁾

¹⁾ Selectivity limit current I_s under 0.5 kA

²⁾ Selectivity limit current I_s = rated breaking capacity I_{cn} of the RCD/MCB device

Darker areas: no selectivity

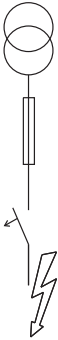

Short circuit selectivity **characteristic C** towards fuse link **D01-D03***)

FRBmM	D01-D03 gL/gG									
	I _n [A]	10	16	20	25	35	50	63	80	100
2		<0.5 ¹⁾	0.5	0.5	2.4	10.0 ²⁾	10.0 ²⁾	10.0 ²⁾	10.0 ²⁾	10.0 ²⁾
4		<0.5 ¹⁾	<0.5 ¹⁾	<0.5 ¹⁾	0.9	3.4	9.5	10.0 ²⁾	10.0 ²⁾	10.0 ²⁾
6			<0.5 ¹⁾	<0.5 ¹⁾	0.8	2.3	6.5	10.0 ²⁾	10.0 ²⁾	10.0 ²⁾
10				<0.5	0.6	1.3	2.9	4.5	8.9	10.0 ²⁾
13						1.2	2.5	3.9	7.6	10.0 ²⁾
16						1.0	2.1	3.0	5.5	10.0 ²⁾
20						1.0	2.0	2.7	5.0	10.0 ²⁾
25							1.9	2.6	4.5	10.0 ²⁾
32								2.1	3.4	10.0 ²⁾
40									3.0	8.7

Short circuit selectivity **characteristic D** towards fuse link **D01-D03***)

FRBmM	D01-D03 gL/gG									
	I _n [A]	10	16	20	25	35	50	63	80	100
2		<0.5 ¹⁾	0.5	0.8	1.2	5.0	10.0 ²⁾	10.0 ²⁾	10.0 ²⁾	10.0 ²⁾
4			<0.5 ¹⁾	0.7	1.0	3.0	10.0 ²⁾	10.0 ²⁾	10.0 ²⁾	10.0 ²⁾
6				0.5	0.8	1.9	5.5	10.0 ²⁾	10.0 ²⁾	10.0 ²⁾
10					0.6	1.3	2.9	4.7	9.2	10.0 ²⁾
13						1.2	2.5	3.8	7.0	10.0 ²⁾
16							2.3	3.2	5.5	10.0 ²⁾
20							2.2	3.0	3.9	10.0 ²⁾

FRBmM-../1N/ and NH-00 fuse link

Short circuit selectivity **characteristic B** towards fuse link **NH-00***)

FRBmM	NH-00 gL/gG												
	I _n [A]	16	20	25	32	35	40	50	63	80	100	125	160
6		<0.5 ¹⁾	0.5	0.8	1.4	2.2	3.3	7.0	10.0 ²⁾	10.0 ²⁾	10.0 ²⁾	10.0 ²⁾	10.0 ²⁾
10			<0.5 ¹⁾	0.7	0.9	1.5	2.1	3.4	4.3	7.3	10.0 ²⁾	10.0 ²⁾	10.0 ²⁾
13			<0.5 ¹⁾	0.6	0.8	1.4	1.8	2.8	3.6	5.7	10.0 ²⁾	10.0 ²⁾	10.0 ²⁾
16				0.6	0.7	1.2	1.5	2.4	3.0	4.5	10.0 ²⁾	10.0 ²⁾	10.0 ²⁾
20					0.7	1.1	1.5	2.2	2.8	4.2	9.2	10.0 ²⁾	10.0 ²⁾
25					0.7	1.1	1.4	2.1	2.6	4.0	8.2	10.0 ²⁾	10.0 ²⁾
32						1.0	1.4	2.0	2.5	3.7	7.1	10.0 ²⁾	10.0 ²⁾
40							2.3	3.4	6.2	8.8	10.0 ²⁾	10.0 ²⁾	

¹⁾ Selectivity limit current I_s under 0.5 kA

²⁾ Selectivity limit current I_s = rated breaking capacity I_{cn} of the RCD/MCB device

Darker areas: no selectivity

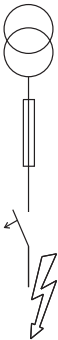

Short circuit selectivity **characteristic C** towards fuse link **NH-00***)

FRBmM	NH-00 gL/gG												
	I _n [A]	16	20	25	32	35	40	50	63	80	100	125	160
2		<0.5 ¹⁾	0.6	2.6	10.0 ²⁾	10.0 ²⁾	10.0 ²⁾	10.0 ²⁾	10.0 ²⁾	10.0 ²⁾	10.0 ²⁾	10.0 ²⁾	10.0 ²⁾
4		<0.5 ¹⁾	<0.5 ¹⁾	0.9	1.8	3.2	4.8	8.7	10.0 ²⁾	10.0 ²⁾	10.0 ²⁾	10.0 ²⁾	10.0 ²⁾
6		<0.5 ¹⁾	<0.5 ¹⁾	0.7	1.3	2.2	3.3	5.9	8.0	10.0 ²⁾	10.0 ²⁾	10.0 ²⁾	10.0 ²⁾
10				0.5	0.8	1.2	1.7	2.7	3.4	5.5	10.0 ²⁾	10.0 ²⁾	10.0 ²⁾
13						1.1	1.5	2.3	2.9	4.7	10.0 ²⁾	10.0 ²⁾	10.0 ²⁾
16						1.0	1.3	1.8	2.3	3.7	8.7	10.0 ²⁾	10.0 ²⁾
20						0.9	1.1	1.7	2.2	3.4	8.0	10.0 ²⁾	10.0 ²⁾
25							1.6	2.1	3.2	7.2	10.0 ²⁾	10.0 ²⁾	
32								1.7	2.6	5.3	9.0	10.0 ²⁾	
40									2.4	4.5	7.5	10.0	

Short circuit selectivity **characteristic D** towards fuse link **NH-00***)

FRBmM	NH-00 gL/gG												
	I _n [A]	16	20	25	32	35	40	50	63	80	100	125	160
2		<0.5 ¹⁾	0.6	1.3	2.5	4.7	7.7	10.0 ²⁾	10.0 ²⁾	10.0 ²⁾	10.0 ²⁾	10.0 ²⁾	10.0 ²⁾
4		<0.5 ¹⁾	0.5	0.9	1.6	2.8	4.3	9.2	10.0 ²⁾	10.0 ²⁾	10.0 ²⁾	10.0 ²⁾	10.0 ²⁾
6			<0.5 ¹⁾	0.7	1.2	1.8	2.6	4.9	7.0	10.0 ²⁾	10.0 ²⁾	10.0 ²⁾	10.0 ²⁾
10				0.5	0.8	1.2	1.7	2.7	3.5	5.6	10.0 ²⁾	10.0 ²⁾	10.0 ²⁾
13						1.1	1.5	2.3	2.9	4.5	10.0 ²⁾	10.0 ²⁾	10.0 ²⁾
16							1.4	2.0	2.6	3.9	8.0	10.0 ²⁾	10.0 ²⁾
20								1.9	2.4	3.6	7.0	10.0 ²⁾	10.0 ²⁾

Combined RCD/MCB Devices FRBmM, FRBm6, 2-pole, Type AC, A

SG02913



- High-quality residual current device / miniature circuit breaker combination, line voltage-independent
- Contact position indicator red - green
- Fault current tripping indicator white - blue
- Guide for secure terminal connection
- 3-position DIN rail clip, permits removal from existing busbar system
- Comprehensive range of accessories suitable for subsequent installation
- Wide variety of rated tripping currents
- Rated currents up to 40 A
- Tripping characteristics B, C
- Rated breaking capacity 10 kA and 6 kA

Combined RCD/MCB Devices FRBmM Type AC

10 kA, 2-pole

Conditionally surge current-proof 250 A, Type AC



SG02913



$I_n/I_{\Delta n}$
(A)

Type
Designation

Article No.

Units
per
package

Characteristic B

10/0.03	FRBmM-B10/2/003	170872	1/60
13/0.03	FRBmM-B13/2/003	170873	1/60
16/0.03	FRBmM-B16/2/003	170874	1/60
20/0.03	FRBmM-B20/2/003	170875	1/60
25/0.03	FRBmM-B25/2/003	170876	1/60
10/0.3	FRBmM-B10/2/03	170837	1/60
13/0.3	FRBmM-B13/2/03	170838	1/60
16/0.3	FRBmM-B16/2/03	170839	1/60
20/0.3	FRBmM-B20/2/03	170840	1/60
25/0.3	FRBmM-B25/2/03	170841	1/60

SG02913



Characteristic C

6/0.03	FRBmM-C6/2/003	170721	1/60
10/0.03	FRBmM-C10/2/003	170722	1/60
13/0.03	FRBmM-C13/2/003	170723	1/60
16/0.03	FRBmM-C16/2/003	170724	1/60
20/0.03	FRBmM-C20/2/003	170725	1/60
25/0.03	FRBmM-C25/2/003	170726	1/60
6/0.3	FRBmM-C6/2/03	170853	1/60
10/0.3	FRBmM-C10/2/03	170854	1/60
13/0.3	FRBmM-C13/2/03	170855	1/60
16/0.3	FRBmM-C16/2/03	170856	1/60
20/0.3	FRBmM-C20/2/03	170857	1/60
25/0.3	FRBmM-C25/2/03	170858	1/60

Combined RCD/MCB Devices FRBmM Type A

10 kA, 2-pole

Conditionally surge current-proof 250 A, sensitive to residual pulsating DC, Type A



SG02913



$I_n/I_{\Delta n}$
(A)

Type
Designation

Article No.

Units
per
package

Characteristic B

10/0.03	FRBmM-B10/2/003-A	170879	1/60
13/0.03	FRBmM-B13/2/003-A	170880	1/60
16/0.03	FRBmM-B16/2/003-A	170881	1/60
20/0.03	FRBmM-B20/2/003-A	170882	1/60
25/0.03	FRBmM-B25/2/003-A	170883	1/60
10/0.1	FRBmM-B10/2/01-A	170803	1/60
13/0.1	FRBmM-B13/2/01-A	170804	1/60
16/0.1	FRBmM-B16/2/01-A	170805	1/60
20/0.1	FRBmM-B20/2/01-A	170806	1/60
25/0.1	FRBmM-B50/2/01-A	170807	1/60
10/0.3	FRBmM-B10/2/03-A	170844	1/60
13/0.3	FRBmM-B13/2/03-A	170845	1/60
16/0.3	FRBmM-B16/2/03-A	170846	1/60
20/0.3	FRBmM-B20/2/03-A	170847	1/60
20/0.3	FRBmM-B25/2/03-A	170848	1/60

SG02913



Characteristic C

6/0.03	FRBmM-C6/2/003-A	170785	1/60
10/0.03	FRBmM-C10/2/003-A	170786	1/60
13/0.03	FRBmM-C13/2/003-A	170787	1/60
16/0.03	FRBmM-C16/2/003-A	170788	1/60
20/0.03	FRBmM-C20/2/003-A	170789	1/60
25/0.03	FRBmM-C25/2/003-A	170790	1/60
6/0.1	FRBmM-C6/2/01-A	170819	1/60
10/0.1	FRBmM-C10/2/01-A	170820	1/60
13/0.1	FRBmM-C13/2/01-A	170821	1/60
16/0.1	FRBmM-C16/2/01-A	170822	1/60
20/0.1	FRBmM-C20/2/01-A	170823	1/60
25/0.1	FRBmM-C25/2/01-A	170824	1/60
6/0.3	FRBmM-C6/2/03-A	170863	1/60
10/0.3	FRBmM-C10/2/03-A	170864	1/60
13/0.3	FRBmM-C13/2/03-A	170865	1/60
16/0.3	FRBmM-C16/2/03-A	170866	1/60
20/0.3	FRBmM-C20/2/03-A	170867	1/60
25/0.3	FRBmM-C25/2/03-A	170730	1/60

Combined RCD/MCB Devices FRBmM Type Super A

10 kA, 2-pole

Conditionally surge current-proof 250 A, sensitive to residual pulsating DC, short-time delayed, Type Super A

	$I_n/I_{\Delta n}$ (A)	Type Designation	Article No.	Units per package
Characteristic B				
	10/0.03	FRBmM-B10/2/003-LiA	170886	1/60
	13/0.03	FRBmM-B13/2/003-LiA	170887	1/60
	16/0.03	FRBmM-B16/2/003-LiA	170888	1/60
	20/0.03	FRBmM-B20/2/003-LiA	170889	1/60
	25/0.03	FRBmM-B25/2/003-LiA	170890	1/60
	10/0.1	FRBmM-B10/2/01-LiA	170810	1/60
	13/0.1	FRBmM-B13/2/01-LiA	170811	1/60
	16/0.1	FRBmM-B16/2/01-LiA	170812	1/60
	20/0.1	FRBmM-B20/2/01-LiA	170813	1/60
	25/0.1	FRBmM-B25/2/01-LiA	170814	1/60

Characteristic C				
	6/0.03	FRBmM-C6/2/003-LiA	170795	1/60
	10/0.03	FRBmM-C10/2/003-LiA	170796	1/60
	13/0.03	FRBmM-C13/2/003-LiA	170797	1/60
	16/0.03	FRBmM-C16/2/003-LiA	170798	1/60
	20/0.03	FRBmM-C20/2/003-LiA	170799	1/60
	25/0.03	FRBmM-C25/2/003-LiA	170800	1/60
	6/0.1	FRBmM-C6/2/01-LiA	170829	1/60
	10/0.1	FRBmM-C10/2/01-LiA	170830	1/60
	13/0.1	FRBmM-C13/2/01-LiA	170831	1/60
	16/0.1	FRBmM-C16/2/01-LiA	170832	1/60
	20/0.1	FRBmM-C20/2/01-LiA	170833	1/60
25/0.1	FRBmM-C25/2/01-LiA	170834	1/60	

Combined RCD/MCB Devices FRBm6 Type AC

6 kA, 2-pole

Conditionally surge current-proof 250 A, Type AC 

	$I_n/I_{\Delta n}$ (A)	Type Designation	Article No.	Units per package
--	---------------------------	---------------------	-------------	-------------------------

SG02813



Characteristic B

32/0.03	FRBm6-B32/2/003	170877	1/60
40/0.03	FRBm6-B40/2/003	170878	1/60
32/0.3	FRBm6-B32/2/03	170842	1/60
40/0.3	FRBm6-B40/2/03	170843	1/60

SG02813



Characteristic C

32/0.03	FRBm6-C32/2/003	170727	1/60
40/0.03	FRBm6-C40/2/003	170728	1/60
32/0.3	FRBm6-C32/2/03	170859	1/60
40/0.3	FRBm6-C40/2/03	170860	1/60

Combined RCD/MCB Devices FRBm6 Type A

6 kA, 2-pole

Conditionally surge current-proof 250 A, sensitive to residual pulsating DC, Type A 

SG02813



$I_n/I_{\Delta n}$
(A)

Type
Designation

Article No.

Units
per
package

Characteristic B

32/0.03	FRBm6-B32/2/003-A	170884	1/60
40/0.03	FRBm6-B40/2/003-A	170885	1/60
32/0.1	FRBm6-B32/2/01-A	170808	1/60
40/0.1	FRBm6-B40/2/01-A	170809	1/60
32/0.3	FRBm6-B32/2/03-A	170849	1/60
40/0.3	FRBm6-B40/2/03-A	170850	1/60

SG02813



Characteristic C

32/0.03	FRBm6-C32/2/003-A	170791	1/60
40/0.03	FRBm6-C40/2/003-A	170792	1/60
32/0.1	FRBm6-C32/2/01-A	170825	1/60
40/0.1	FRBm6-C40/2/01-A	170826	1/60
32/0.3	FRBm6-C32/2/03-A	170731	1/60
40/0.3	FRBm6-C40/2/03-A	170732	1/60

Combined RCD/MCB Devices FRBm6 Type Super A

6 kA, 2-pole

Conditionally surge current-proof 250 A, sensitive to residual pulsating DC, short-time delayed, Type Super A 

	$I_n/I_{\Delta n}$ (A)	Type Designation	Article No.	Units per package
--	---------------------------	---------------------	-------------	-------------------------

SG02813



Characteristic B

32/0.03	FRBm6-B32/2/003-LiA	170891	1/60
40/0.03	FRBm6-B40/2/003-LiA	170718	1/60
32/0.1	FRBm6-B32/2/01-LiA	170815	1/60
40/0.1	FRBm6-B40/2/01-LiA	170816	1/60

SG02813



Characteristic C

32/0.03	FRBm6-C32/2/003-LiA	170801	1/60
40/0.03	FRBm6-C40/2/003-LiA	170802	1/60
32/0.1	FRBm6-C32/2/01-LiA	170835	1/60
40/0.1	FRBm6-C40/2/01-LiA	170836	1/60

Specifications | Combined RCD/MCB Devices FRBmM, FRBm6, 2-pole

Description

- Combined RCD/MCB device
- Line voltage-independent tripping
- Compatible with standard busbar
- Twin-purpose terminal (lift/open-mouthed) above and below
- Busbar positioning optionally above or below
- Free terminal space despite installed busbar
- Guide for secure terminal connection
- Contact position indicator red - green
- Fault current tripping indicator white - blue
- Comprehensive range of accessories suitable for subsequent installation
- The test key "T" must be pressed every 6 months. The system operator must be informed of this obligation and his responsibility in a way that can be proven. Under special conditions (e.g. damply and/or dusty environments, environments with polluting and/or corroding conditions, environments with large temperature fluctuations, installations with a risk of overvoltages due to switching of equipment and/or atmospheric discharges, portable equipment ...), it's recommended to test in monthly intervals.
- Pressing the test key "T" serves the only purpose of function testing the residual current device (RCD). This test does not make earthing resistance measurement (R_E), or proper checking of the earth conductor condition redundant, which must be performed separately.
- **Type -A:** Protects against special forms of residual pulsating DC which have not been smoothed.
- **Type -Super A:** High reliability against unwanted tripping. Compulsory for any circuit where personal injury or damage to property may occur in case of unwanted tripping.

Accessories:

Auxiliary switch for subsequent installation	ZP-IHK	286052
	ZP-WHK	286053
	ZP-NHK	248437
Shunt trip release	ZP-ASA/..	248438, 248439
Switching interlock	IS/SPE-1TE	101911
Terminal cover 2-pole	Z-CV/SD-2P	178099

Technical Data

		FRBmM, FRBm6, 2-pole
Electrical		
Design according to		IEC/EN 61009
Current test marks as printed onto the device		
Tripping line voltage-independent		instantaneous 250A (8/20µs), surge current-proof
Type Super A		10 ms delay, surge current-proof
Rated voltage	U_n	240V AC, 50Hz
Rated tripping current	$I_{\Delta n}$	30, 100, 300 mA
Rated non-tripping current	$I_{\Delta no}$	$0.5 I_{\Delta n}$
Sensitivity		AC and pulsating DC
Selectivity class		3
Rated breaking capacity	I_{cn}	
FRBmM		10 kA
FRBm6		6 kA
Rated current		6 - 40 A
Rated impulse withstand voltage	U_{imp}	4 kV (1.2/50µs)
Characteristic		B, C
Maximum back-up fuse (short circuit)		100 A gL (>10 kA)
Endurance		
electrical components		≥ 4,000 operating cycles
mechanical components		≥ 10,000 operating cycles
Mechanical		
Frame size		45 mm
Device height		80 mm
Device width		35 mm (2MU)
Mounting		3-position DIN rail clip, permits removal from existing busbar system
Degree of protection switch		IP20
Degree of protection, built-in		IP40
Upper and lower terminals		open mouthed/lift terminals
Terminal protection		finger and hand touch safe, VBG4, ÖVE-EN 6
Terminal capacity		1 - 25 mm ²
Terminal torque		2 - 2.4 Nm
Busbar thickness		0.8 - 2 mm
Operation temperature		-25°C to +40°C
Storage- and transport temperature		-35°C to +60°C
Climatic conditions		acc. to IEC 68-2 (25..55°C / 90..95% RH)

Connection diagram

2-pole

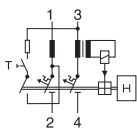

Dimensions (mm)

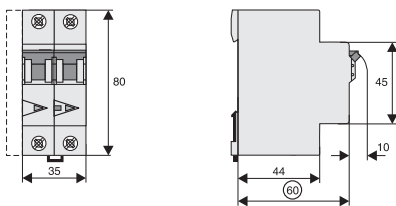

Tripping Characteristic FRBm. 2-pole., Characteristics B and C

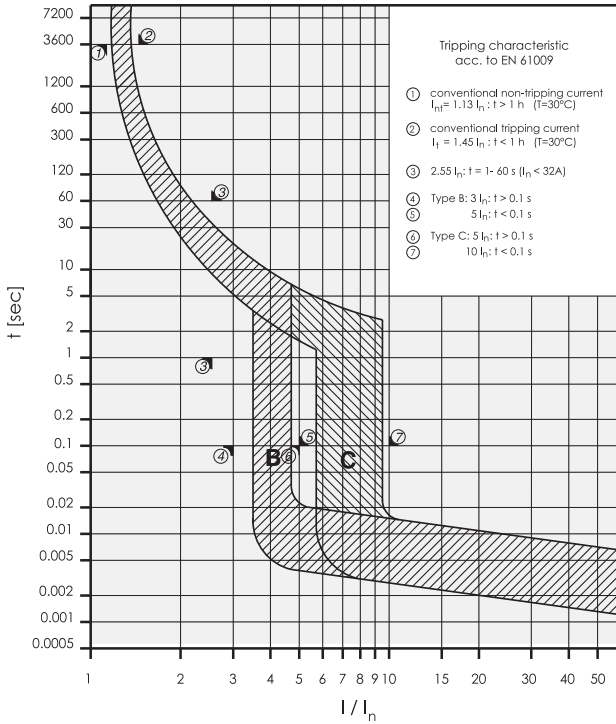

Internal Resistance FRBmM 2-pole

At room temperature (single pole)

I _n [A]	Type B		Type C	
	R* [mΩ]	R* [mΩ]	R* [mΩ]	R* [mΩ]
6	29,7	29,7		
10	19,1	19,1		
13	17,4	17,4		
16	12,2	12,2		
20	9,3	9,3		
25	4,9	4,9		
32	5,6	5,6		
40	4,6	4,6		

* 50Hz

Internal Resistance FRBm6 2-pole

At room temperature (single pole)

I _n [A]	Type B/C	
	R* [mΩ]	R* [mΩ]
10	36.1	
13	25.9	
16	18.6	
20	14.2	
25	8.0	
32	7.3	
40	5.6	

* 50Hz

Power Loss at I_n FRBmM 2-pole

(entire unit)

I _n [A]	Type B		Type C	
	P* [W]	P* [W]	P* [W]	P* [W]
6	2,2	2,2		
10	4,3	4,3		
13	4,0	4,0		
16	5,0	5,0		
20	5,9	5,9		
25	4,6	4,6		
32	5,5	5,5		
40	6,7	6,7		

* 50Hz

Power Loss at I_n FRBm6 2-pole

(entire unit)

I _n [A]	Type B/C	
	P* [W]	P* [W]
10	4.1	
13	5.2	
16	5.7	
20	7.0	
25	5.6	
32	8.7	
40	10.9	

* 50Hz

FRBmM: Influence of ambient temperature on load carrying capacity

- Values = max. allowed current in Ampere at the specific temperature
- Temperature factor (%/K) = 0,5

	Ambient temperature / °C									
	-40	-30	-25	-20	-10	0	10	20	30	40
6	8,1	7,8	7,7	7,5	7,2	6,9	6,6	6,3	6,0	5,7
10	13,5	13,0	12,8	12,5	12,0	11,5	11,0	10,5	10,0	9,5
13	17,6	16,9	16,6	16,3	15,6	15,0	14,3	13,7	13,0	12,4
16	21,6	20,8	20,4	20,0	19,2	18,4	17,6	16,8	16,0	15,2
20	27,0	26,0	25,5	25,0	24,0	23,0	22,0	21,0	20,0	19,0

FRBm6: Influence of ambient temperature on load carrying capacity

- Values = max. allowed current in Ampere at the specific temperature
- Temperature factor (%/K) = 0,5

	Ambient temperature / °C									
	-40	-30	-25	-20	-10	0	10	20	30	40
25	33,8	32,5	31,9	31,3	30,0	28,8	27,5	26,3	25,0	23,8
32	43,2	41,6	40,8	40,0	38,4	36,8	35,2	33,6	32,0	30,4
40	54,0	52,0	51,0	50,0	48,0	46,0	44,0	42,0	40,0	38,0

Let-through Energy FRBmM 2-poles

Let-through energy FRBmM, characteristic B, 2-pole

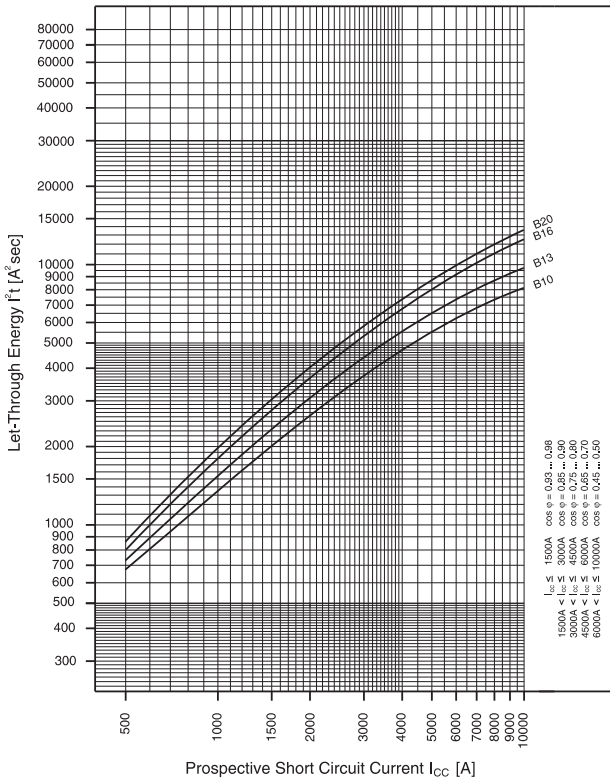

Let-through energy FRBmM, characteristic C, 2-pole

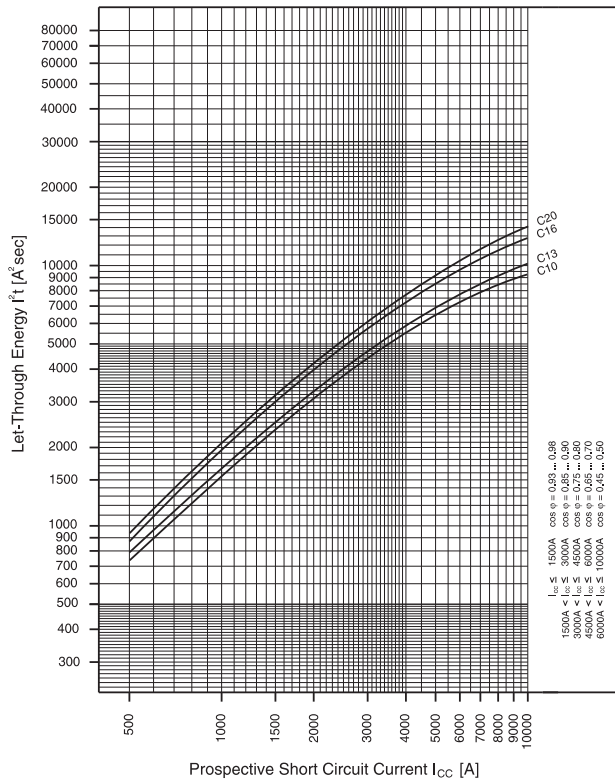

Let-through Energy FRBm6 2-poles

Let-through energy FRBm6, characteristic B, 2-pole

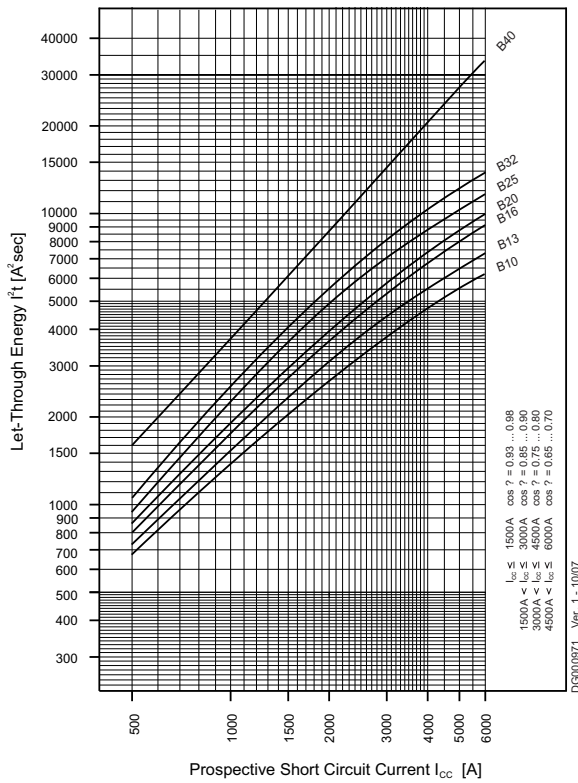

Let-through energy FRBm6, characteristic C, 2-pole

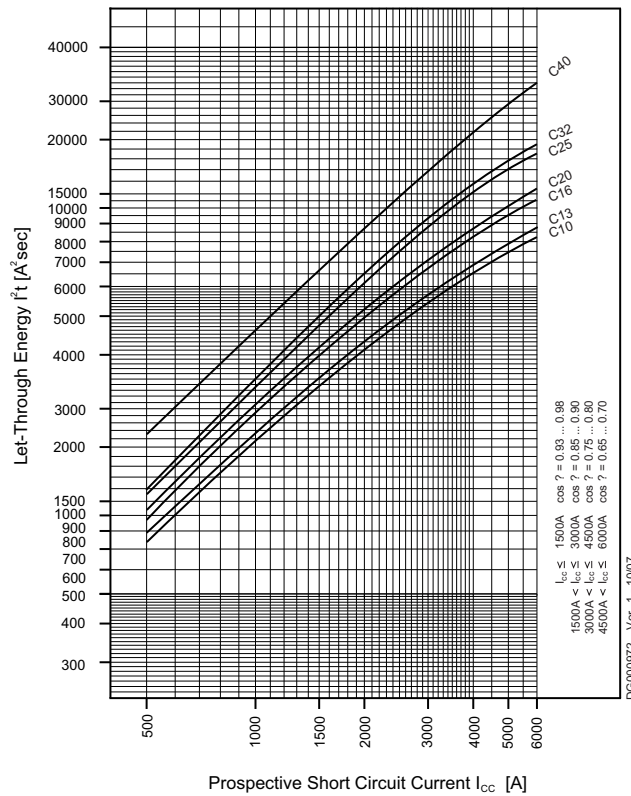

Let-through Current FRBmM 2-poles

Characteristic B

230 V

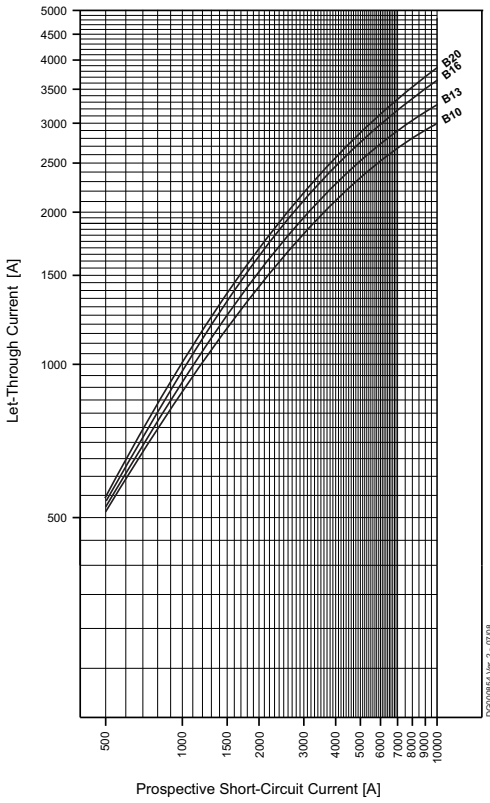

Characteristic C

230 V

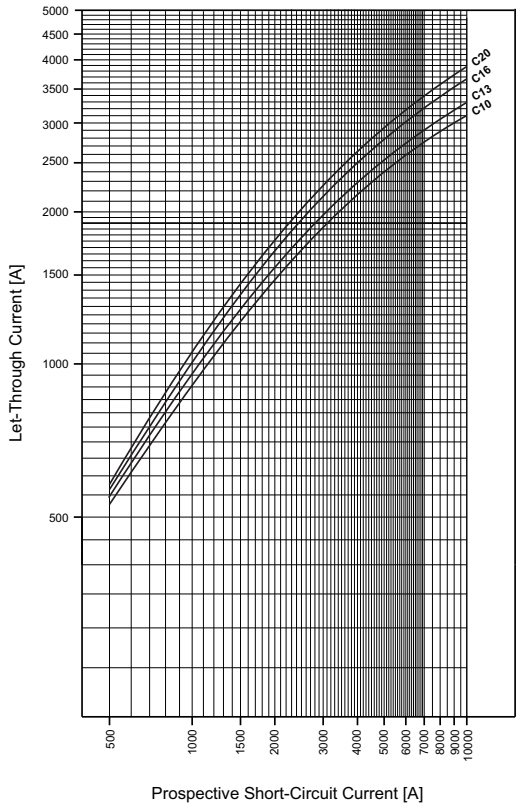

Let-through Current FRBm6 2-poles

Characteristic B

230V

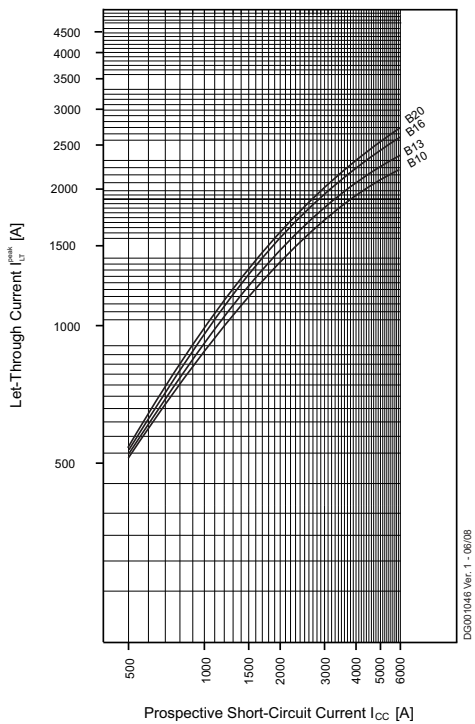

Characteristic C

230V

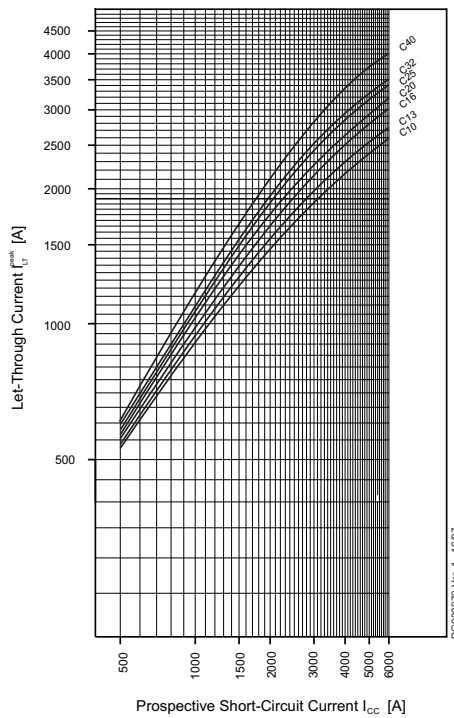

Short-circuit Selectivity FRBmM 2-pole

In case of a short-circuit, selectivity is provided up to the specified selective current values I_s (kA) applicable between the FRBmM RCD/MCB circuit breakers and the up-stream protective devices.

When a short-circuit occurs, this means that with I_{KS} current values below I_s only the MCB will trip. However, in case of short-circuit currents beyond these values both protective devices will trip.

FRBmM 2-poles and NZM1/NZM2

Short circuit currents in kA, Rated currents of fuses in A

Overload and short-circuit release unit NZM at max. value

FRBmM	NZM...1-A...						FRBmM	NZM...2-A...								
	$I_{cu} = 25 (50) \text{ kA}$							$I_{cu} = 25 (50)(100)(150) \text{ kA}$								
	40	50	63	80	100	125	40	50	63	80	100	125	160	200	250	
B10	1.2	1.5	2	2	4	10	1	1.5	2.5	3	10	10	10	10	10	
B13	1	1.5	2	2	4	10	1	1.2	2	3	10	10	10	10	10	
B16	1	1.2	1.5	2	3	8	1	1.2	1.5	2.5	10	10	10	10	10	
B20	0.8	1.2	1.5	1.5	3	8	1	1.2	1.5	1.5	10	10	10	10	10	
C10	1.2	1.5	2	2	4	10	1	1.5	2.5	3	10	10	10	10	10	
C13	1	1.5	2	2	4	10	1	1.2	2	3	10	10	10	10	10	
C16	1	1.2	1.5	2	3	8	1	1.2	1.5	2.5	10	10	10	10	10	
C20	0.8	1.2	1.5	1.5	3	8	1	1.2	1.5	1.5	10	10	10	10	10	

FRBmM 2-poles and PLSM-OV/PLHT-OV

Short circuit currents in kA, Rated currents of fuses in A

FRBmM	PLSM-OV/PLHT-OV						
	$I_{cu} = 10 \text{ kA}$						
	25	32	40	50	56	63	80
B+C10	1.5	1.5	1.5	1.5	1.5	1.5	1.5
B+C13	1.5	1.5	1.5	1.5	1.5	1.5	1.5
B+C16	1.5	1.5	1.5	1.5	1.5	1.5	1.5
B+C20	-	1.5	1.5	1.5	1.5	1.5	1.5

FRBmM 2-poles and Neozed¹⁾ / Diazed²⁾ / NH00³⁾

Short circuit currents in kA, Rated currents of fuses in A

Short circuit selectivity **FRBmM** towards fuse link **Neozed**¹⁾

FRBm	Neozed ¹⁾									
	16	20	25	32	35	40	50	63	80	100
B10	<0,5	0,5	0,9	2	2,3	3,7	8	10	10	10
B13	<0,5	0,5	0,8	1,7	1,9	3	6	10	10	10
B16	-	0,5	0,7	1,5	1,7	2,4	4,4	6,8	10	10
B20	-	-	0,7	1,4	1,5	2,2	3,9	6	9,2	10
C10	<0,5	0,5	0,8	1,7	1,9	3	6,1	10	10	10
C13	<0,5	0,5	0,7	1,6	1,8	2,8	5,5	9,5	10	10
C16	-	<0,5	0,7	1,3	1,5	2,2	4	6,2	10	10
C20	-	-	0,6	1,3	1,4	2,1	3,7	5,6	8,5	10

Short circuit selectivity **FRBmM** towards fuse link **Diazed**²⁾

FRBm	Diazed ²⁾								
	16	20	25	32	35	50	63	80	100
B10	<0,5	0,5	0,9	1,8	2,9	5,6	10	10	10
B13	<0,5	0,5	0,8	1,5	2,4	4,5	10	10	10
B16	-	0,5	0,8	1,3	2	3,4	8	10	10
B20	-	-	0,7	1,3	1,9	3,1	7,1	10	10
C10	<0,5	0,5	0,8	1,5	2,4	4,4	10	10	10
C13	<0,5	0,5	0,8	1,4	2,3	4,2	10	10	10
C16	-	<0,5	0,7	1,2	1,9	3,2	7,6	10	10
C20	-	-	0,7	1,2	1,8	2,9	6,5	9,7	10

Short circuit selectivity **FRBmM** towards fuse link **NH00**³⁾

FRBm	NH00 ³⁾											
	16	20	25	32	35	40	50	63	80	100	125	160
B10	<0,5	<0,5	0,8	1,5	2,3	3,2	5,7	9,1	10	10	10	10
B13	<0,5	<0,5	0,8	1,3	1,9	2,7	4,4	6,5	10	10	10	10
B16	-	<0,5	0,7	1,1	1,6	2,2	3,4	4,8	8	10	10	10
B20	-	-	0,6	1	1,4	2	3,1	4,3	7	10	10	10
C10	<0,5	<0,5	0,7	1,3	1,9	2,7	4,5	6,9	10	10	10	10
C13	<0,5	<0,5	0,7	1,2	1,8	2,5	4,1	6,1	10	10	10	10
C16	-	<0,5	0,6	1	1,5	2	3,1	4,4	7,5	10	10	10
C20	-	-	0,6	0,9	1,4	1,9	2,9	4,1	6,5	10	10	10

¹⁾ SIEMENS Type 5SE2; Size: D01, D02, D03; Operating class gG; Rated voltage: AC 400 V/DC 250 V

²⁾ SIEMENS Type 5SB2, 5SB4, 5SC2; Size: DII, DIII, DIV; Operating class gG; Rated voltage: AC 500 V/DC 500 V

³⁾ SIEMENS Type 3NA3 8, 3NA6 8, 3NA7 8; Size: 000, 00; Operating class gG; Rated voltage: AC 500 V/DC 250 V

FRBm6 2-poles and NZM1/NZM2

Short circuit currents in kA, Rated currents of fuses in A

Overload and short-circuit release unit NZM at max. value

FRBm6	NZMB(C)(N)(H)1-A...						FRBm6	NZMB(C)(N)(H)2-A...								
	$I_{cu} = I_{cu} = 25 (36)(50)(100) \text{ kA}$							$I_{cu} = 25 (36)(50)(150) \text{ kA}$								
	40	50	63	80	100	125	40	50	63	80	100	125	160	200	250	
B10	1	1.3	1.6	1.6	3.5	6	0.9	1.3	2.5	2.5	6	6	6	6	6	
B13	0.9	1.3	1.6	1.6	3.5	6	0.9	1	1.6	2.5	6	6	6	6	6	
B16	0.9	1	1.5	1.6	2.5	6	0.9	1	1.3	2.1	6	6	6	6	6	
B20	0.6	1	1.3	1.3	2.5	6	0.9	1	1.3	1.3	6	6	6	6	6	
B25	0.6	1	1.3	1.3	2.5	6	0.6	0.9	1.3	1.6	6	6	6	6	6	
B32	-	1	0.9	1.3	1.6	5	-	0.9	1.3	1.6	6	6	6	6	6	
B40	-	-	0.9	1.3	1.6	4.3	-	-	1	1.3	5	5	5	5	6	
C10	1	1.3	1.6	1.6	3.5	6	0.9	1.3	2.5	2.5	6	6	6	6	6	
C13	0.9	1.3	1.6	1.6	3.5	6	0.9	1	1.6	2.5	6	6	6	6	6	
C16	0.9	1	1.5	1.6	2.5	6	0.9	1	1.3	2.1	6	6	6	6	6	
C20	0.6	1	1.3	1.3	2.5	6	0.9	1	1.3	1.3	6	6	6	6	6	
C25	0.6	1	1.3	1.3	2.5	6	0.6	0.9	1.3	1.6	6	6	6	6	6	
C32	-	1	0.9	1.3	1.6	5	-	0.9	1.3	1.6	6	6	6	6	6	
C40	-	-	0.9	1.3	1.6	4.3	-	-	1	1.3	5	5	5	5	6	

FRBm6 2-poles and PLSM-OV/PLHT-OV

Short circuit currents in kA, Rated currents of fuses in A

FRBm6	PLSM-OV/PLHT-OV						
	$I_{cu} = 10 \text{ kA}$						
	25	32	40	50	56	63	80
B+C10	1.5	1.5	1.5	1.5	1.5	1.5	1.5
B+C13	1.5	1.5	1.5	1.5	1.5	1.5	1.5
B+C16	1.5	1.5	1.5	1.5	1.5	1.5	1.5
B+C20	-	1.5	1.5	1.5	1.5	1.5	1.5
B+C25	-	-	1.5	1.5	1.5	1.5	1.5
B+C32	-	-	-	1.5	1.5	1.5	1.5
B+C40	-	-	-	-	1.5	1.5	1.5

FRBm6 2-poles and Neozed¹⁾ / Diazed²⁾ / NH00³⁾

Short circuit currents in kA, Rated currents of fuses in A

Short circuit selectivity **FRBm6** towards fuse link **Neozed**¹⁾

FRBm6	Neozed ¹⁾									
	16	20	25	32	35	40	50	63	80	100
B25	-	-	-	1,2	1,3	1,8	3,1	4,7	6	6
B32	-	-	-	-	1,2	1,7	2,7	3,8	5,5	6
B40	-	-	-	-	-	1,3	1,7	2,2	2,7	4,2
C25	-	-	-	1,1	1,3	1,8	2,8	3,9	5,6	6
C32	-	-	-	-	1,2	1,7	2,6	3,6	5,1	6
C40	-	-	-	-	-	1,3	1,9	3,3	3,2	5,8

Short circuit selectivity **FRBm6** towards fuse link **Diazed**¹⁾

FRBm6	Diazed ²⁾								
	16	20	25	32	35	50	63	80	100
B25	-	-	-	1,1	1,5	2,4	5,5	6	6
B32	-	-	-	-	1,4	2,1	4,3	6	6
B40	-	-	-	-	-	1,4	2,4	2,9	5,1
C25	-	-	-	1,1	1,5	2,3	4,4	6	6
C32	-	-	-	-	1,4	2,2	4,1	5,6	6
C40	-	-	-	-	-	1,6	2,8	3,6	6

Short circuit selectivity **FRBm6** towards fuse link **NH00**³⁾

FRBm6	NH00 ³⁾											
	16	20	25	32	35	40	50	63	80	100	125	160
B25	-	-	-	0,9	1,2	1,6	2,4	3,4	5,5	6	6	6
B32	-	-	-	-	1,1	1,4	2,1	2,9	4,3	6	6	6
B40	-	-	-	-	-	-	1,4	1,9	2,8	4,1	6	6
C25	-	-	-	0,9	1,2	1,6	2,3	3	4,6	6	6	6
C32	-	-	-	-	1,1	1,5	2,1	2,8	4,3	6	6	6
C40	-	-	-	-	-	-	1,5	2,1	3,1	5,4	6	6

¹⁾ SIEMENS Type 5SE2; Size: D01, D02, D03; Operating class gG; Rated voltage: AC 400 V/DC 250 V

²⁾ SIEMENS Type 5SB2, 5SB4, 5SC2; Size: DII, DIII, DIV; Operating class gG; Rated voltage: AC 500 V/DC 500 V

³⁾ SIEMENS Type 3NA3 8, 3NA6 8, 3NA7 8; Size: 000, 00; Operating class gG; Rated voltage: AC 500 V/DC 250 V

Back-up Protection FRBmM 2-pole

The up-stream protective devices will protect the down-stream FRBmM up to the short-circuit current specified.

FRBmM 2-poles and NZM1

Short circuit currents in kA.

FRBmM	NZMB1
B, C, D	IT-system U = 230 V
10	20
13	20
16	20
20	15

$U_e = 230\text{ V}$: I_{cu} (FRBmM2) = 10 kA (acc. to IEC/EN 61009)
 $U_e = 400/415\text{ V}$: I_{cu} (NZMB1) = 25 kA (acc. to IEC/EN 60947-2)

Short circuit currents in kA.

FRBmM	NZMC1
B, C, D	IT-system U = 230 V
10	20
13	20
16	20
20	20

$U_e = 230\text{ V}$: I_{cu} (FRBmM2) = 10 kA (acc. to IEC/EN 61009)
 $U_e = 400/415\text{ V}$: I_{cu} (NZMC1) = 36 kA (acc. to IEC/EN 60947-2)

Short circuit currents in kA.

FRBmM	NZMN1
B, C, D	IT-system U = 230 V
10	25
13	25
16	25
20	20

$U_e = 230\text{ V}$: I_{cu} (FRBmM2) = 10 kA (acc. to IEC/EN 61009)
 $U_e = 400/415\text{ V}$: I_{cu} (NZMN1) = 50 kA (acc. to IEC/EN 60947-2)

Short circuit currents in kA.

FRBmM	NZMH1
B, C, D	IT-system U = 230 V
10	30
13	30
16	30
20	20

$U_e = 230\text{ V}$: I_{cu} (FRBmM2) = 10 kA (acc. to IEC/EN 61009)
 $U_e = 400/415\text{ V}$: I_{cu} (NZMH1) = 100 kA (acc. to IEC/EN 60947-2)

Back-up tests acc. to IEC/EN 60947-2, app. A: $U = 1.05 U_e$, (O - t - CO)

FRBmM 2-poles and NZM2

Short circuit currents in kA.

FRBmM	NZMB2
B, C, D	IT-system U = 230 V
10	25
13	25
16	25
20	25

$U_e = 230\text{ V}$: I_{cu} (FRBmM2) = 10 kA (acc. to IEC/EN 61009)
 $U_e = 400/415\text{ V}$: I_{cu} (NZMH2) = 25 kA (acc. to IEC/EN 60947-2)

Short circuit currents in kA.

FRBmM	NZMC2
B, C, D	IT-system U = 230 V
10	36
13	36
16	36
20	36

$U_e = 230\text{ V}$: I_{cu} (FRBmM2) = 10 kA (acc. to IEC/EN 61009)
 $U_e = 400/415\text{ V}$: I_{cu} (NZMH2) = 36 kA (acc. to IEC/EN 60947-2)

Short circuit currents in kA.

FRBmM	NZMN2
B, C, D	IT-system U = 230 V
10	40
13	40
16	40
20	40

$U_e = 230\text{ V}$: I_{cu} (FRBmM2) = 10 kA (acc. to IEC/EN 61009)
 $U_e = 400/415\text{ V}$: I_{cu} (NZMH2) = 50 kA (acc. to IEC/EN 60947-2)

Short circuit currents in kA.

FRBmM	NZMH2
B, C, D	IT-system U = 230 V
10	40
13	40
16	40
20	40

$U_e = 230\text{ V}$: I_{cu} (FRBmM2) = 10 kA (acc. to IEC/EN 61009)
 $U_e = 400/415\text{ V}$: I_{cu} (NZMH2) = 100 kA (acc. to IEC/EN 60947-2)

Back-up tests acc. to IEC/EN 60947-2, app. A: $U = 1.05 U_e$, (O - t - CO)

FRBmM 2-poles and LZM1

Short circuit currents in kA.

FRBmM	LZMB1
	IT-system U = 230 V
B, C, D	
10	20
13	20
16	20
20	15

$U_e = 230\text{ V}$: I_{cu} (FRBmM2) = 10 kA (acc. to IEC/EN 61009)
 $U_e = 400/415\text{ V}$: I_{cu} (LZMB1) = 25 kA (acc. to IEC/EN 60947-2)

Short circuit currents in kA.

FRBmM	LZMN1
	IT-system U = 230 V
B, C, D	
10	25
13	25
16	25
20	20

$U_e = 230\text{ V}$: I_{cu} (FRBmM2) = 10 kA (acc. to IEC/EN 61009)
 $U_e = 400/415\text{ V}$: I_{cu} (LZMN1) = 50 kA (acc. to IEC/EN 60947-2)

Back-up tests acc. to IEC/EN 60947-2, app. A: $U = 1.05 U_e$, (O - t - CO)

Short circuit currents in kA.

FRBmM	LZMC1
	IT-system U = 230 V
B, C, D	
10	20
13	20
16	20
20	20

$U_e = 230\text{ V}$: I_{cu} (FRBmM2) = 10 kA (acc. to IEC/EN 61009)
 $U_e = 400/415\text{ V}$: I_{cu} (LZMC1) = 36 kA (acc. to IEC/EN 60947-2)

Short circuit currents in kA.

FRBmM	LZMS1
	IT-system U = 230 V
B, C, D	
10	30
13	30
16	30
20	20

$U_e = 230\text{ V}$: I_{cu} (FRBmM2) = 10 kA (acc. to IEC/EN 61009)
 $U_e = 400/415\text{ V}$: I_{cu} (LZMS1) = 70 kA (acc. to IEC/EN 60947-2)

FRBmM 2-poles and LZM2

Short circuit currents in kA.

FRBmM	LZMB2
	IT-system U = 230 V
B, C, D	
10	25
13	25
16	25
20	25

$U_e = 230\text{ V}$: I_{cu} (FRBmM2) = 10 kA (acc. to IEC/EN 61009)
 $U_e = 400/415\text{ V}$: I_{cu} (LZMB2) = 25 kA (acc. to IEC/EN 60947-2)

Short circuit currents in kA.

FRBmM	LZMN2
	IT-system U = 230 V
B, C, D	
10	40
13	40
16	40
20	40

$U_e = 230\text{ V}$: I_{cu} (FRBmM2) = 10 kA (acc. to IEC/EN 61009)
 $U_e = 400/415\text{ V}$: I_{cu} (LZMN2) = 50 kA (acc. to IEC/EN 60947-2)

Short circuit currents in kA.

FRBmM	LZMC2
	IT-system U = 230 V
B, C, D	
10	36
13	36
16	36
20	36

$U_e = 230\text{ V}$: I_{cu} (FRBmM2) = 10 kA (acc. to IEC/EN 61009)
 $U_e = 400/415\text{ V}$: I_{cu} (LZMC2) = 36 kA (acc. to IEC/EN 60947-2)

Short circuit currents in kA.

FRBmM	LZMS2
	IT-system U = 230 V
B, C, D	
10	40
13	40
16	40
20	40

$U_e = 230\text{ V}$: I_{cu} (FRBmM2) = 10 kA (acc. to IEC/EN 61009)
 $U_e = 400/415\text{ V}$: I_{cu} (LZMS2) = 70 kA (acc. to IEC/EN 60947-2)

Back-up tests acc. to IEC/EN 60947-2, app. A: $U = 1.05 U_e$, (O - t - CO)

FRBmM 2-poles and PLSM-OV, NH00 gG/gL

Short circuit currents in kA.

FRBmM	PLSM-OV63/2,3,4,3N IT-system U = 230 V
B, C, D	
10	10
13	10
16	10
20	10

$U_e = 230 \text{ V}$: I_{cu} (FRBmM2) = 10 kA (acc. to IEC/EN 61009)

$U_e = 230/400 \text{ V}$: I_{cn} (PLSM-OV63) = 10 kA (acc. to IEC/EN 60947-2)

Short circuit currents in kA.

FRBmM	NH00 125 A gG/gL IT-system U = 230 V
B, C, D	
10	40
13	40
16	40
20	40

$U_e = 230 \text{ V}$: I_{cu} (FRBmM2) = 10 kA (acc. to IEC/EN 61009)

AC 500 V: (NH00 125A gG/gL) = 120 kA (acc. to IEC60269)

Back-up tests acc. to IEC/EN 60947-2, app. A: $U = 1.05 U_e$, (O - t - CO)

Back-up Protection FRBm6 2-pole

The up-stream protective devices will protect the down-stream FRBm6 up to the short-circuit current specified.

FRBm6 2-poles and NZM1

Short circuit currents in kA.

FRBm6	NZMB1-A...
B, C, D	IT-system U = 230 V
10	20
13	20
16	20
20	15
25	15
32	15
40	15

$U_e = 230\text{ V}$: I_{cu} (FRBm62) = 6 kA (acc. to IEC/EN 61009)
 $U_e = 400/415\text{ V}$: I_{cu} (NZMB1) = 25 kA (acc. to IEC/EN 60947-2)

Short circuit currents in kA.

FRBm6	NZMN1-A...
B, C, D	IT-system U = 230 V
10	25
13	25
16	25
20	20
25	20
32	20
40	20

$U_e = 230\text{ V}$: I_{cu} (FRBm62) = 6 kA (acc. to IEC/EN 61009)
 $U_e = 400/415\text{ V}$: I_{cu} (NZMN1) = 50 kA (acc. to IEC/EN 60947-2)

Back-up tests acc. to IEC/EN 60947-2, app. A: $U = 1.05 U_e$, (O - t - CO)

Short circuit currents in kA.

FRBm6	NZMC1-A...
B, C, D	IT-system U = 230 V
10	20
13	20
16	20
20	20
25	20
32	20
40	20

$U_e = 230\text{ V}$: I_{cu} (FRBm62) = 6 kA (acc. to IEC/EN 61009)
 $U_e = 400/415\text{ V}$: I_{cu} (NZMC1) = 36 kA (acc. to IEC/EN 60947-2)

Short circuit currents in kA.

FRBm6	NZMH1-A...
B, C, D	IT-system U = 230 V
10	20
13	20
16	20
20	15
25	15
32	15
40	15

$U_e = 230\text{ V}$: I_{cu} (FRBm62) = 6 kA (acc. to IEC/EN 61009)
 $U_e = 400/415\text{ V}$: I_{cu} (NZMH1) = 100 kA (acc. to IEC/EN 60947-2)

FRBm6 2-poles and NZM2

Short circuit currents in kA.

FRBm6	NZMB2-A...
B, C, D	IT-system U = 230 V
10	20
13	20
16	20
20	15
25	15
32	15
40	10

$U_e = 230\text{ V}$: I_{cu} (FRBm62) = 6 kA (acc. to IEC/EN 61009)
 $U_e = 400/415\text{ V}$: I_{cu} (NZMB2) = 25 kA (acc. to IEC/EN 60947-2)

Short circuit currents in kA.

FRBm6	NZMN2-A...
B, C, D	IT-system U = 230 V
10	30
13	30
16	30
20	20
25	20
32	20
40	10

$U_e = 230\text{ V}$: I_{cu} (FRBm62) = 6 kA (acc. to IEC/EN 61009)
 $U_e = 400/415\text{ V}$: I_{cu} (NZMN2) = 50 kA (acc. to IEC/EN 60947-2)

Back-up tests acc. to IEC/EN 60947-2, app. A: $U = 1.05 U_e$, (O - t - CO)

Short circuit currents in kA.

FRBm6	NZMC2-A...
B, C, D	IT-system U = 230 V
10	25
13	25
16	25
20	20
25	20
32	20
40	10

$U_e = 230\text{ V}$: I_{cu} (FRBm62) = 6 kA (acc. to IEC/EN 61009)
 $U_e = 400/415\text{ V}$: I_{cu} (NZMC2) = 36 kA (acc. to IEC/EN 60947-2)

Short circuit currents in kA.

FRBm6	NZMH2-A...
B, C, D	IT-system U = 230 V
10	30
13	30
16	30
20	25
25	25
32	25
40	10

$U_e = 230\text{ V}$: I_{cu} (FRBm62) = 6 kA (acc. to IEC/EN 61009)
 $U_e = 400/415\text{ V}$: I_{cu} (NZMH2) = 100 kA (acc. to IEC/EN 60947-2)

FRBm6 2-poles and LZM1

Short circuit currents in kA.

FRBm6	LZMB1-A...
	IT-system U = 230 V
B, C, D	
10	20
13	20
16	20
20	15
25	15
32	15
40	15

$U_e = 230\text{ V}$: I_{cu} (FRBm62) = 6 kA (acc. to IEC/EN 61009)
 $U_e = 400/415\text{ V}$: I_{cu} (LZMB1) = 25 kA (acc. to IEC/EN 60947-2)

Short circuit currents in kA.

FRBm6	LZMN1-A...
	IT-system U = 230 V
B, C, D	
10	25
13	25
16	25
20	20
25	20
32	20
40	20

$U_e = 230\text{ V}$: I_{cu} (FRBm62) = 6 kA (acc. to IEC/EN 61009)
 $U_e = 400/415\text{ V}$: I_{cu} (LZMN1) = 50 kA (acc. to IEC/EN 60947-2)

Back-up tests acc. to IEC/EN 60947-2, app. A: $U = 1.05 U_e$, (O - t - CO)

Short circuit currents in kA.

FRBm6	LZMC1-A...
	IT-system U = 230 V
B, C, D	
10	20
13	20
16	20
20	20
25	20
32	20
40	20

$U_e = 230\text{ V}$: I_{cu} (FRBm62) = 6 kA (acc. to IEC/EN 61009)
 $U_e = 400/415\text{ V}$: I_{cu} (LZMC1) = 36 kA (acc. to IEC/EN 60947-2)

Short circuit currents in kA.

FRBm6	LZMS1-A...
	IT-system U = 230 V
B, C, D	
10	30
13	30
16	30
20	20
25	20
32	20
40	20

$U_e = 230\text{ V}$: I_{cu} (FRBm62) = 6 kA (acc. to IEC/EN 61009)
 $U_e = 400/415\text{ V}$: I_{cu} (LZMS1) = 70 kA (acc. to IEC/EN 60947-2)

FRBm6 2-poles and LZM2

Short circuit currents in kA.

FRBm6	LZMB2-A...
	IT-system U = 230 V
B, C, D	
10	20
13	20
16	20
20	15
25	15
32	15
40	10

$U_e = 230\text{ V}$: I_{cu} (FRBm62) = 6 kA (acc. to IEC/EN 61009)
 $U_e = 400/415\text{ V}$: I_{cu} (LZMB2) = 25 kA (acc. to IEC/EN 60947-2)

Short circuit currents in kA.

FRBm6	LZMN2-A...
	IT-system U = 230 V
B, C, D	
10	25
13	25
16	25
20	20
25	20
32	20
40	20

$U_e = 230\text{ V}$: I_{cu} (FRBm62) = 6 kA (acc. to IEC/EN 61009)
 $U_e = 400/415\text{ V}$: I_{cu} (LZMN2) = 50 kA (acc. to IEC/EN 60947-2)

Back-up tests acc. to IEC/EN 60947-2, app. A: $U = 1.05 U_e$, (O - t - CO)

Short circuit currents in kA.

FRBm6	LZMC2-A...
	IT-system U = 230 V
B, C, D	
10	20
13	20
16	20
20	20
25	20
32	20
40	20

$U_e = 230\text{ V}$: I_{cu} (FRBm62) = 6 kA (acc. to IEC/EN 61009)
 $U_e = 400/415\text{ V}$: I_{cu} (LZMC2) = 36 kA (acc. to IEC/EN 60947-2)

Short circuit currents in kA.

FRBm6	LZMS2-A...
	IT-system U = 230 V
B, C, D	
10	30
13	30
16	30
20	20
25	20
32	20
40	20

$U_e = 230\text{ V}$: I_{cu} (FRBm62) = 6 kA (acc. to IEC/EN 61009)
 $U_e = 400/415\text{ V}$: I_{cu} (LZMS2) = 70 kA (acc. to IEC/EN 60947-2)

FRBm6 2-poles and PLSM-OV, NH00 gG/gL

Short circuit currents in kA.

FRBm6	PLSM-OV63/2,3,4,3N
B, C, D	IT-system U = 230 V
10	10
13	10
16	10
20	10
25	10
32	10
40	10

$U_e = 230 \text{ V}$: I_{cu} (FRBm62) = 6 kA (acc. to IEC/EN 61009)

$U_e = 230/400 \text{ V}$: I_{cn} PLSM-OV63) = 10 kA (acc. to IEC/EN 60947-2)

Short circuit currents in kA.

FRBm6	NH00 100 A gG/gL
B, C, D	IT-system U = 230 V
10	40
13	40
16	40
20	40
25	40
32	40
40	40

$U_e = 230 \text{ V}$: I_{cu} (FRBm62) = 6 kA (acc. to IEC/EN 61009)

AC 500 V: (NH00 125A gG/gL) = 120 kA (acc. to IEC60269)

Back-up tests acc. to IEC/EN 60947-2, app. A: $U = 1.05 U_e$, (O - t - CO)

Combined RCD/MCB Devices FRBmM, 3-pole, Type A

SG02013



- High-quality residual current device / miniature circuit breaker combination, line voltage-independent
- Contact position indicator red - green
- Fault current tripping indicator white - blue
- Guide for secure terminal connection
- 3-position DIN rail clip, permits removal from existing busbar system
- Comprehensive range of accessories suitable for subsequent installation
- Wide variety of rated tripping currents
- Rated currents up to 32 A
- Tripping characteristics B, C, D
- Rated breaking capacity 10 kA

Combined RCD/MCB Devices FRBmM Type A

10 kA, 3-pole

Conditionally surge current-proof 250 A, sensitive to residual pulsating DC, Type A



	$I_n/I_{\Delta n}$ (A)	Type Designation	Article No.	Units per package	
Characteristic B					
	10/0.03	FRBmM-B10/3/003-A	170733	1/30	
	13/0.03	FRBmM-B13/3/003-A	170734	1/30	
	16/0.03	FRBmM-B16/3/003-A	170735	1/30	
	20/0.03	FRBmM-B20/3/003-A	170736	1/30	
	10/0.1	FRBmM-B10/3/01-A	170780	1/30	
	13/0.1	FRBmM-B13/3/01-A	170781	1/30	
	16/0.1	FRBmM-B16/3/01-A	170782	1/30	
	20/0.1	FRBmM-B20/3/01-A	170783	1/30	
	Characteristic C				
		6/0.03	FRBmM-C6/3/003-A	170737	1/30
10/0.03		FRBmM-C10/3/003-A	170738	1/30	
13/0.03		FRBmM-C13/3/003-A	170739	1/30	
16/0.03		FRBmM-C16/3/003-A	170740	1/30	
20/0.03		FRBmM-C20/3/003-A	170741	1/30	
25/0.03		FRBmM-C25/3/003-A	170772	1/30	
32/0.03		FRBmM-C32/3/003-A	170773	1/30	
6/0.1		FRBmM-C6/3/01-A	170742	1/30	
10/0.1		FRBmM-C10/3/01-A	170743	1/30	
13/0.1		FRBmM-C13/3/01-A	170744	1/30	
16/0.1		FRBmM-C16/3/01-A	170745	1/30	
20/0.1		FRBmM-C20/3/01-A	170746	1/30	
25/0.1		FRBmM-C25/3/01-A	170747	1/30	
32/0.1		FRBmM-C32/3/01-A	170748	1/30	
Characteristic D					
	6/0.03	FRBmM-D6/3/003-A	170774	1/30	
	10/0.03	FRBmM-D10/3/003-A	170775	1/30	
	13/0.03	FRBmM-D13/3/003-A	170776	1/30	
	16/0.03	FRBmM-D16/3/003-A	170777	1/30	
	20/0.03	FRBmM-D20/3/003-A	170778	1/30	
	25/0.03	FRBmM-D25/3/003-A	170779	1/30	
	6/0.1	FRBmM-D6/3/01-A	170749	1/30	
	10/0.1	FRBmM-D10/3/01-A	170750	1/30	
	13/0.1	FRBmM-D13/3/01-A	170751	1/30	
	16/0.1	FRBmM-D16/3/01-A	170752	1/30	
20/0.1	FRBmM-D20/3/01-A	170753	1/30		
25/0.1	FRBmM-D25/3/01-A	170754	1/30		

Specifications | Combined RCD/MCB Devices FRBmM, 3-pole

Description

- Combined RCD/MCB device
- Line voltage-independent tripping
- Compatible with standard busbar
- Twin-purpose terminal (lift/open-mouthed) above and below
- Busbar positioning optionally above or below
- Free terminal space despite installed busbar
- Guide for secure terminal connection
- Contact position indicator red - green
- Fault current tripping indicator white - blue
- Comprehensive range of accessories suitable for subsequent installation
- The test key "T" must be pressed every 6 months. The system operator must be informed of this obligation and his responsibility in a way that can be proven. Under special conditions (e.g. damply and/or dusty environments, environments with polluting and/or corroding conditions, environments with large temperature fluctuations, installations with a risk of overvoltages due to switching of equipment and/or atmospheric discharges, portable equipment ...), it's recommended to test in monthly intervals.
- Pressing the test key "T" serves the only purpose of function testing the residual current device (RCD). This test does not make earthing resistance measurement (R_E), or proper checking of the earth conductor condition redundant, which must be performed separately.
- **Type -A:** Protects against special forms of residual pulsating DC which have not been smoothed.
- **Type -G:** High reliability against unwanted tripping. Compulsory for any circuit where personal injury or damage to property may occur in case of unwanted tripping (ÖVE/ÖNORM E 8001-1 § 12.1.6).

Accessories:

Auxiliary switch for subsequent installation	ZP-IHK	286052
	ZP-WHK	286053
Tripping signal contact for subsequent installation	ZP-NHK	248437
Shunt trip release	ZP-ASA/..	248438, 248439
Switching interlock	IS/SPE-1TE	101911
Terminal cover 4-pole	Z-CV/SD-4P	178101

Technical Data

		FRBmM, 3-pole
Electrical		
Design according to		IEC/EN 61009
Current test marks as printed onto the device		
Tripping line voltage-independent		instantaneous 250A (8/20 μ s), surge current-proof
Type G		10 ms delay, surge current-proof
Rated voltage	U_n	240/415V AC, 50Hz
Rated tripping current	$I_{\Delta n}$	30, 100 mA
Rated non-tripping current	$I_{\Delta no}$	0.5 $I_{\Delta n}$
Sensitivity		AC and pulsating DC
Selectivity class		3
Rated breaking capacity	I_{cn}	10 kA
Rated current		6 - 32 A
Rated impulse withstand voltage	U_{imp}	4 kV (1.2/50 μ s)
Characteristic		B, C, D
Maximum back-up fuse (short circuit)		100 A gL (>10 kA)
Endurance		
electrical components		\geq 4,000 operating cycles
mechanical components		\geq 10,000 operating cycles
Mechanical		
Frame size		45 mm
Device height		80 mm
Device width		70 mm (4MU)
Mounting		3-position DIN rail clip, permits removal from existing busbar system
Degree of protection switch		IP20
Degree of protection, built-in		IP40
Upper and lower terminals		open mouthed/lift terminals
Terminal protection		finger and hand touch safe, VBG4, ÖVE-EN 6
Terminal capacity		1 - 25 mm ²
Terminal torque		2 - 2.4 Nm
Busbar thickness		0.8 - 2 mm
Operation temperature		-25°C to +40°C
Storage- and transport temperature		-35°C to +60°C
Climatic conditions		acc. to IEC 68-2 (25..55°C / 90..95% RH)

Connection diagram

3-pole

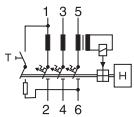

Dimensions (mm)

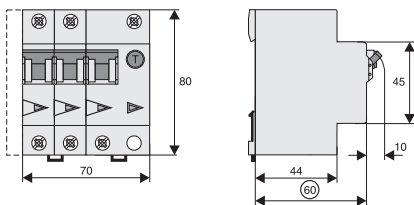

Tripping Characteristic FRBmM 3-pole, Characteristics B, C and D

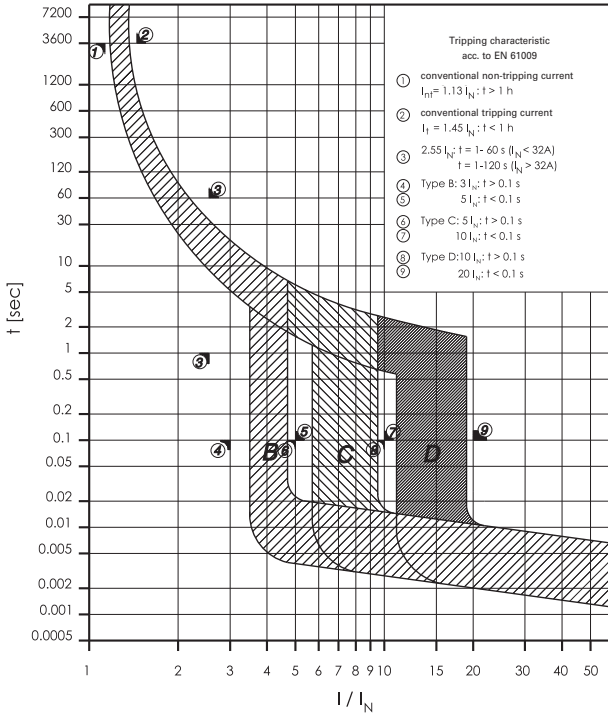

Internal Resistance FRBmM 3-pole

At room temperature (single pole)

In [A]	Type B	Type C	Type D
	Z* [mΩ]	Z* [mΩ]	Z* [mΩ]
6	-	34	34
10	22	56	20
13	38	31	9.8
16	28	27	9.3
20	7.4	6.4	6.6
25	-	4.2	3.9
32	-	3.1	-

* 50Hz

Power Loss at I_n FRBmM 3-pole

(entire unit)

In [A]	Type B	Type C	Type D
	P* [W]	P* [W]	P* [W]
6	-	4.0	4.0
10	7.6	6.3	6.5
13	8.9	9.0	5.9
16	8.3	8.6	9.0
20	11.3	9.2	9.7
25	-	9.4	9.2
32	-	12.8	-

* 50Hz

Maximum Let-Through Energy FRBmM 3-pole

Type B

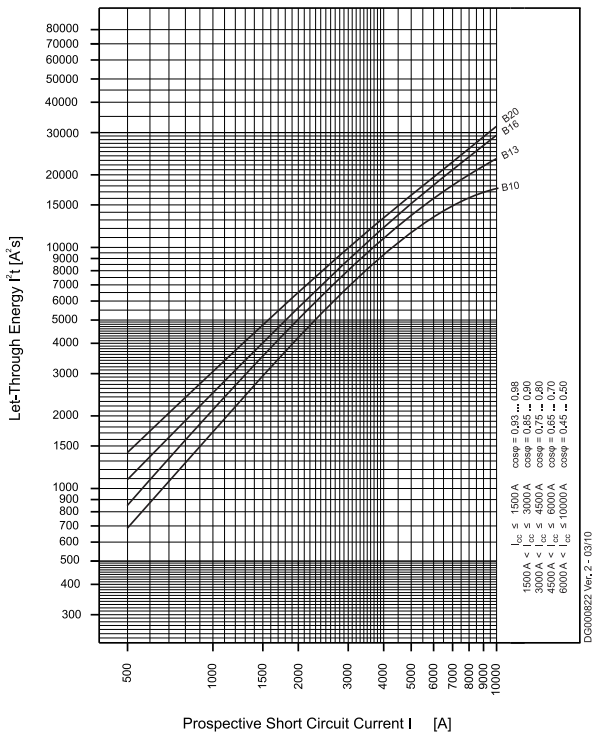

Type C

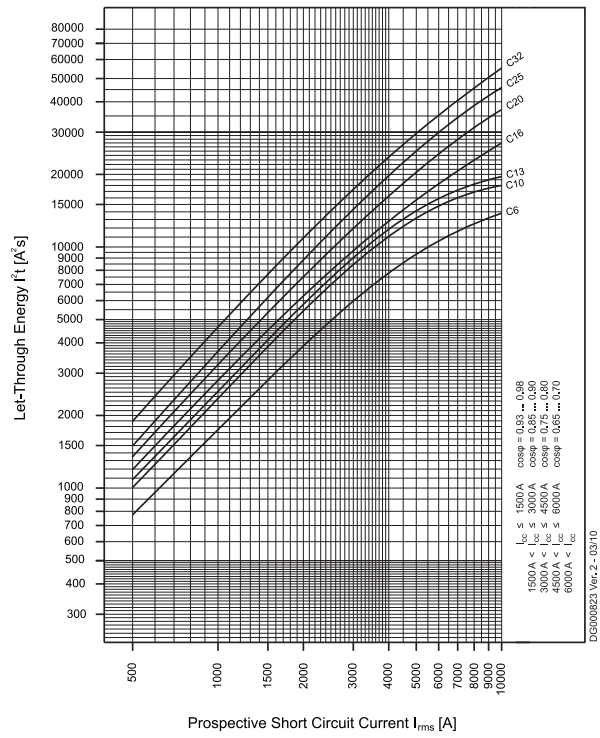

Type D

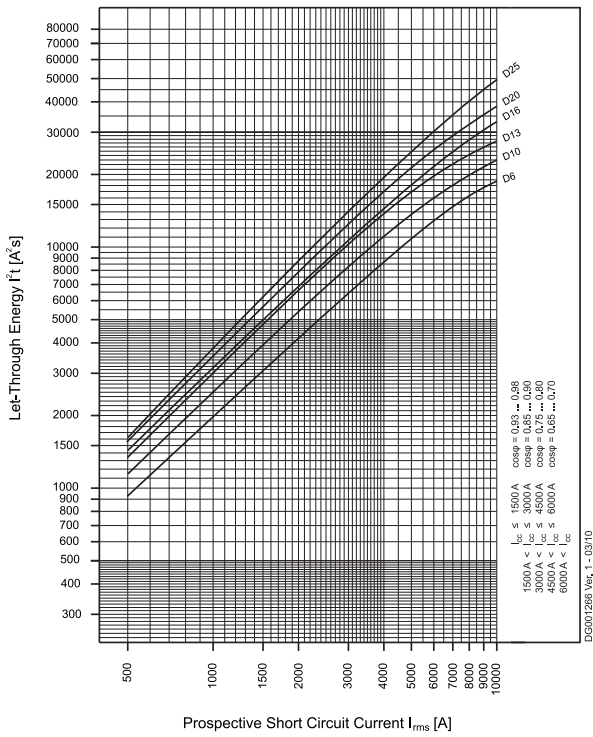

Maximum Let-Through Current FRBmM 3-pole

Type B

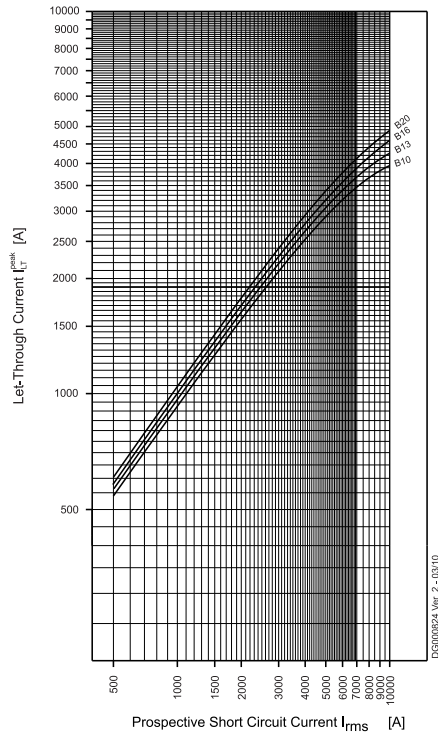

Type C

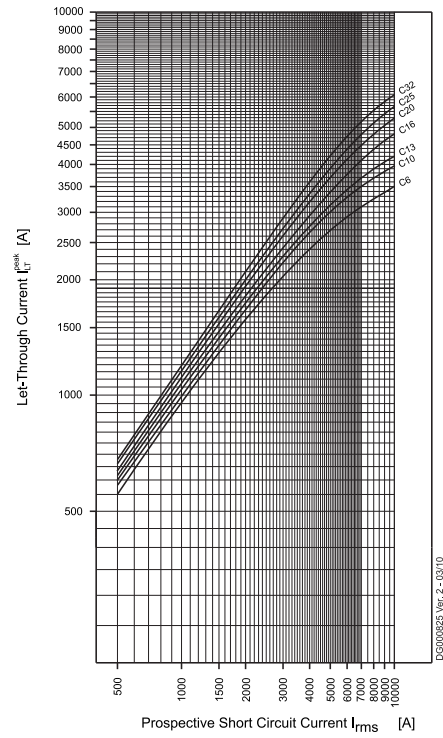

Type D

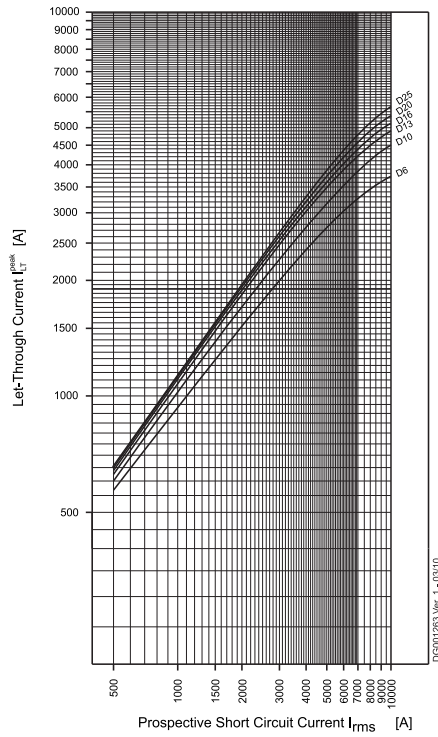

Short-circuit Selectivity FRBmM, 3-pole

In case of a short-circuit, selectivity is provided up to the specified selective current values I_s (kA) applicable between the FRBmM RCD/MCB circuit breakers and the up-stream protective devices.

When a short-circuit occurs, this means that with I_{KS} current values below I_s only the MCB will trip. However, in case of short-circuit currents beyond these values both protective devices will trip.

FRBmM, 3-pole, characteristic B and NZM 1/2

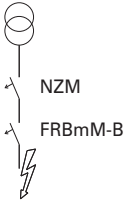

Selectivity-limit current I_s [kA] for selectivity between FRBmM-.../B and NZM (overload and short-circuit release unit NZM at max. value).

I_n [A]	NZM...1-A...						NZM...2-A...								
	$I_{cu} = 25(36)(50)(100)$ kA bei $U_e = 400/415$ V						$I_{cu} = 25(36)(50)(150)$ kA bei $U_e = 400/415$ V								
FRBmM-B	40	50	63	80	100	125	40	50	63	80	100	125	160	200	250
10	1.2	1.5	2	2	4	10	1	1.5	2.5	3	10	10	10	10	10
13	1	1.5	2	2	4	10	1	1.2	2	3	10	10	10	10	10
16	1	1.2	1.5	2	3	8	1	1.2	1.5	2.5	10	10	10	10	10
20	0.8	1.2	1.5	1.5	3	8	1	1.2	1.5	1.5	10	10	10	10	10

FRBmM, 3-pole, characteristic C and NZM 1/2

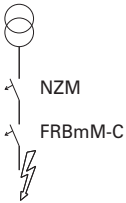

Selectivity-limit current I_s [kA] for selectivity between FRBmM-.../C and NZM (overload and short-circuit release unit NZM at max. value).

I_n [A]	NZM...1-A...						NZM...2-A...								
	$I_{cu} = 25(36)(50)(100)$ kA bei $U_e = 400/415$ V						$I_{cu} = 25(36)(50)(150)$ kA bei $U_e = 400/415$ V								
FRBmM-C	40	50	63	80	100	125	40	50	63	80	100	125	160	200	250
6	1.2	2	2.5	3	5	10	1.2	1.5	2.5	3	10	10	10	10	10
10	1.2	1.5	2	2	4	10	1	1.5	2.5	3	10	10	10	10	10
13	1	1.5	2	2	4	10	1	1.2	2	3	10	10	10	10	10
16	1	1.2	1.5	2	3	8	1	1.2	1.5	2.5	10	10	10	10	10
20	0.8	1.2	1.5	1.5	3	8	1	1.2	1.5	1.5	10	10	10	10	10
25	0.7	1.2	1.5	1.5	3	7	0.8	1	1.5	2	10	10	10	10	10
32	-	1.2	1	1.5	2	6	-	1	1.5	2	6	6	6	6	6

FRBmM, 3-pole, characteristic D and NZM 1/2

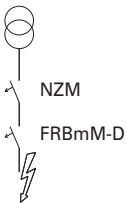

Selectivity-limit current I_s [kA] for selectivity between FRBmM-.../D and NZM (overload and short-circuit release unit NZM at max. value).

I_n [A]	NZM...1-A...						NZM...2-A...								
	$I_{cu} = 25(36)(50)(100)$ kA bei $U_e = 400/415$ V						$I_{cu} = 25(36)(50)(150)$ kA bei $U_e = 400/415$ V								
FRBmM-D	40	50	63	80	100	125	40	50	63	80	100	125	160	200	250
6	1.2	2	2.5	3	5	10	1.2	1.5	2.5	3	10	10	10	10	10
10	1.2	1.5	2	2	4	10	1	1.5	2.5	3	10	10	10	10	10
13	1	1.5	2	2	4	10	1	1.2	2	3	10	10	10	10	10
16	1	1.2	1.5	2	3	8	1	1.2	1.5	2.5	10	10	10	10	10
20	0.8	1.2	1.5	1.5	3	8	1	1.2	1.5	1.5	10	10	10	10	10
25	0.7	1.2	1.5	1.5	3	7	0.8	1	1.5	2	10	10	10	10	10

Back-up Protection FRBmM 3-pole

The up-stream protective devices will protect the down-stream FRBmM up to the short-circuit current specified.

FRBmM 3-pole and NZMB(C)(N)(H)1

FRBmM 3-pole and NZMB1

$U_e = 133 / 230 \text{ V}$

I_n [A]	FRBmM- $I_n/3/B(C)(D)/003(01)(03) + \text{NZMB1}$		
	Type B	Type C	Type D
6	-	25kA	25kA
10	25kA	25kA	25kA
13	25kA	25kA	25kA
16	25kA	25kA	25kA
20	25kA	25kA	25kA
25	-	25kA	25kA
32	-	25kA	-

FRBmM 3-pole and NZMC1

$U_e = 133 / 230 \text{ V}$

I_n [A]	FRBmM- $I_n/3/B(C)(D)/003(01)(03) + \text{NZMC1}$		
	Type B	Type C	Type D
6	-	36kA	36kA
10	36kA	36kA	36kA
13	36kA	36kA	36kA
16	36kA	36kA	36kA
20	36kA	36kA	36kA
25	-	36kA	36kA
32	-	36kA	-

FRBmM 3-pole and NZMN1

$U_e = 133 / 230 \text{ V}$

I_n [A]	FRBmM- $I_n/3/B(C)(D)/003(01)(03) + \text{NZMN1}$		
	Type B	Type C	Type D
6	-	50kA	50kA
10	50kA	50kA	50kA
13	50kA	50kA	50kA
16	50kA	50kA	50kA
20	50kA	50kA	50kA
25	-	50kA	50kA
32	-	50kA	-

FRBmM 3-pole and NZMH1

$U_e = 133 / 230 \text{ V}$

I_n [A]	FRBmM- $I_n/3/B(C)(D)/003(01)(03) + \text{NZMH1}$		
	Type B	Type C	Type D
6	-	70kA	70kA
10	70kA	70kA	70kA
13	70kA	70kA	70kA
16	70kA	70kA	70kA
20	70kA	70kA	70kA
25	-	70kA	70kA
32	-	70kA	-

FRBmM 3-pole and NZMB(C)(N)(H)2

FRBmM 3-pole and NZMB2

$U_e = 133 / 230 \text{ V}$

I_n [A]	FRBmM- $I_n/3/B(C)(D)/003(01)(03) + \text{NZMB2}$		
	Type B	Type C	Type D
6	-	25kA	25kA
10	25kA	25kA	25kA
13	25kA	25kA	25kA
16	25kA	25kA	25kA
20	25kA	25kA	25kA
25	-	25kA	25kA
32	-	25kA	-

FRBmM 3-pole and NZMC2

$U_e = 133 / 230 \text{ V}$

I_n [A]	FRBmM- $I_n/3/B(C)(D)/003(01)(03) + \text{NZMC2}$		
	Type B	Type C	Type D
6	-	36kA	36kA
10	36kA	36kA	36kA
13	36kA	36kA	36kA
16	36kA	36kA	36kA
20	36kA	36kA	36kA
25	-	36kA	36kA
32	-	36kA	-

FRBmM 3-pole and NZMN2

$U_e = 133 / 230 \text{ V}$

I_n [A]	FRBmM- $I_n/3/B(C)(D)/003(01)(03) + \text{NZMN2}$		
	Type B	Type C	Type D
6	-	50kA	50kA
10	50kA	50kA	50kA
13	50kA	50kA	50kA
16	50kA	50kA	50kA
20	50kA	50kA	50kA
25	-	50kA	50kA
32	-	50kA	-

FRBmM 3-pole and NZMH2

$U_e = 133 / 230 \text{ V}$

I_n [A]	FRBmM- $I_n/3/B(C)(D)/003(01)(03) + \text{NZMH2}$		
	Type B	Type C	Type D
6	-	70kA	70kA
10	70kA	70kA	70kA
13	70kA	70kA	70kA
16	70kA	70kA	70kA
20	70kA	70kA	70kA
25	-	70kA	70kA
32	-	70kA	-

FRBmM 3-pole and NH00

FRBmM 3-pole and NH00 125A gG/gL

$U_e = 133 / 230 \text{ V}$

I_n [A]	FRBmM-I_n/3/B(C)(D)/003(01)(03) + NH00 125A gG/gL		
	Type B	Type C	Type D
6	-	70kA	70kA
10	70kA	70kA	70kA
13	70kA	70kA	70kA
16	70kA	70kA	70kA
20	70kA	70kA	70kA
25	-	70kA	70kA
32	-	70kA	-



Combined RCD/MCB Devices FRBm6, FRBm4, 3+N-pole, Type AC und A

SG02213



- High-quality residual current device / miniature circuit breaker combination, line voltage-independent
- Contact position indicator red - green
- Fault current tripping indicator white - blue
- Guide for secure terminal connection
- 3-position DIN rail clip, permits removal from existing busbar system
- Comprehensive range of accessories suitable for subsequent installation
- Wide variety of rated tripping currents
- Rated currents up to 32 A
- Tripping characteristics B, C, D
- Rated breaking capacity 6 kA or 4.5 kA

Combined RCD/MCB Devices FRBm6 Type AC
6 kA, 3+N-pole
Conditionally surge current-proof 250 A, Type AC 



	$I_n/I_{\Delta n}$ (A)	Type Designation	Article No.	Units per package
Characteristic B				
	13/0.03	FRBm6-B13/3N/003	170985	1/30
	16/0.03	FRBm6-B16/3N/003	170986	1/30
	13/0.1	FRBm6-B13/3N/01	170896	1/30
	16/0.1	FRBm6-B16/3N/01	170897	1/30
	13/0.3	FRBm6-B13/3N/03	170943	1/30
	16/0.3	FRBm6-B16/3N/03	170944	1/30
Characteristic C				
	6/0.03	FRBm6-C6/3N/003	170989	1/30
	10/0.03	FRBm6-C10/3N/003	170990	1/30
	13/0.03	FRBm6-C13/3N/003	170991	1/30
	16/0.03	FRBm6-C16/3N/003	170992	1/30
	6/0.1	FRBm6-C6/3N/01	170900	1/30
	10/0.1	FRBm6-C10/3N/01	170901	1/30
	13/0.1	FRBm6-C13/3N/01	170902	1/30
	16/0.1	FRBm6-C16/3N/01	170903	1/30
	6/0.3	FRBm6-C6/3N/03	170947	1/30
	10/0.3	FRBm6-C10/3N/03	170948	1/30
	13/0.3	FRBm6-C13/3N/03	170949	1/30
	16/0.3	FRBm6-C16/3N/03	170950	1/30
	Characteristic D			
	6/0.03	FRBm6-D6/3N/003	171003	1/30
	10/0.03	FRBm6-D10/3N/003	171004	1/30
	13/0.03	FRBm6-D13/3N/003	171005	1/30
	16/0.03	FRBm6-D16/3N/003	171006	1/30
	6/0.1	FRBm6-D6/3N/01	170933	1/30
	10/0.1	FRBm6-D10/3N/01	170934	1/30
	13/0.1	FRBm6-D13/3N/01	170935	1/30
	16/0.1	FRBm6-D16/3N/01	170936	1/30
	6/0.3	FRBm6-D6/3N/03	170961	1/30
	10/0.3	FRBm6-D10/3N/03	170962	1/30
	13/0.3	FRBm6-D13/3N/03	170963	1/30
	16/0.3	FRBm6-D16/3N/03	170964	1/30

Combined RCD/MCB Devices FRBm6 Type A

6 kA, 3+N-pole

Conditionally surge current-proof 250 A, sensitive to residual pulsating DC, Type A



	$I_n/I_{\Delta n}$ (A)	Type Designation	Article No.	Units per package	
Characteristic B					
	13/0.03	FRBm6-B13/3N/003-A	170987	1/30	
	16/0.03	FRBm6-B16/3N/003-A	170988	1/30	
	13/0.1	FRBm6-B13/3N/01-A	170898	1/30	
	16/0.1	FRBm6-B16/3N/01-A	170899	1/30	
	13/0.3	FRBm6-B13/3N/03-A	170945	1/30	
	16/0.3	FRBm6-B16/3N/03-A	170946	1/30	
Characteristic C					
	6/0.03	FRBm6-C6/3N/003-A	170996	1/30	
	10/0.03	FRBm6-C10/3N/003-A	170997	1/30	
	13/0.03	FRBm6-C13/3N/003-A	170998	1/30	
	16/0.03	FRBm6-C16/3N/003-A	170999	1/30	
	6/0.1	FRBm6-C6/3N/01-A	170926	1/30	
	10/0.1	FRBm6-C10/3N/01-A	170927	1/30	
	13/0.1	FRBm6-C13/3N/01-A	170928	1/30	
	16/0.1	FRBm6-C16/3N/01-A	170929	1/30	
	6/0.3	FRBm6-C6/3N/03-A	170954	1/30	
	10/0.3	FRBm6-C10/3N/03-A	170955	1/30	
	13/0.3	FRBm6-C13/3N/03-A	170956	1/30	
	16/0.3	FRBm6-C16/3N/03-A	170957	1/30	
	Characteristic D				
		6/0.03	FRBm6-D6/3N/003-A	171008	1/30
10/0.03		FRBm6-D10/3N/003-A	170892	1/30	
13/0.03		FRBm6-D13/3N/003-A	170893	1/30	
16/0.03		FRBm6-D16/3N/003-A	170894	1/30	
6/0.1		FRBm6-D6/3N/01-A	170938	1/30	
10/0.1		FRBm6-D10/3N/01-A	170939	1/30	
13/0.1		FRBm6-D13/3N/01-A	170940	1/30	
16/0.1		FRBm6-D16/3N/01-A	170941	1/30	
6/0.3		FRBm6-D6/3N/03-A	170966	1/30	
10/0.3		FRBm6-D10/3N/03-A	170967	1/30	
13/0.3		FRBm6-D13/3N/03-A	170968	1/30	
16/0.3		FRBm6-D16/3N/03-A	170969	1/30	

Combined RCD/MCB Devices FRBm4 Type AC
4.5 kA, 3+N-pole
Conditionally surge current-proof 250 A, Type AC 

	$I_n/I_{\Delta n}$ (A)	Type Designation	Article No.	Units per package
Characteristic C				
	20/0.03	FRBm4-C20/3N/003	170993	1/30
	25/0.03	FRBm4-C25/3N/003	170994	1/30
	32/0.03	FRBm4-C32/3N/003	170995	1/30
	20/0.1	FRBm4-C20/3N/01	170923	1/30
	25/0.1	FRBm4-C25/3N/01	170924	1/30
	32/0.1	FRBm4-C32/3N/01	170925	1/30
	20/0.3	FRBm4-C20/3N/03	170951	1/30
	25/0.3	FRBm4-C25/3N/03	170952	1/30
	32/0.3	FRBm4-C32/3N/03	170953	1/30

	Characteristic D			
	20/0.03	FRBm4-D20/3N/003	171007	1/30
	20/0.1	FRBm4-D20/3N/01	170937	1/30
	20/0.3	FRBm4-D20/3N/03	170965	1/30

Combined RCD/MCB Devices FRBm4 Type A

4.5 kA, 3+N-pole

Conditionally surge current-proof 250 A, sensitive to residual pulsating DC, Type A



	$I_n/I_{\Delta n}$ (A)	Type Designation	Article No.	Units per package
Characteristic C				
	20/0.03	FRBm4-C20/3N/003-A	171000	1/30
	25/0.03	FRBm4-C25/3N/003-A	171001	1/30
	32/0.03	FRBm4-C32/3N/003-A	171002	1/30
	20/0.1	FRBm4-C20/3N/01-A	170930	1/30
	25/0.1	FRBm4-C25/3N/01-A	170931	1/30
	32/0.1	FRBm4-C32/3N/01-A	170932	1/30
	20/0.3	FRBm4-C20/3N/03-A	170958	1/30
	25/0.3	FRBm4-C25/3N/03-A	170959	1/30
	32/0.3	FRBm4-C32/3N/03-A	170960	1/30

	$I_n/I_{\Delta n}$ (A)	Type Designation	Article No.	Units per package
Characteristic D				
	20/0.03	FRBm4-D20/3N/003-A	170895	1/30
	20/0.1	FRBm4-D20/3N/01-A	170942	1/30
	20/0.3	FRBm4-D20/3N/03-A	170970	1/30

Specifications | Combined RCD/MCB Devices FRBm6, FRBm4, 3+N-pole

Description

- Combined RCD/MCB device
- Line voltage-independent tripping
- Compatible with standard busbar
- Twin-purpose terminal (lift/open-mouthed) above and below
- Busbar positioning optionally above or below
- Free terminal space despite installed busbar
- Guide for secure terminal connection
- Contact position indicator red - green
- Fault current tripping indicator white - blue
- Comprehensive range of accessories suitable for subsequent installation
- The test key "T" must be pressed every 6 months. The system operator must be informed of this obligation and his responsibility in a way that can be proven. Under special conditions (e.g. damply and/or dusty environments, environments with polluting and/or corroding conditions, environments with large temperature fluctuations, installations with a risk of overvoltages due to switching of equipment and/or atmospheric discharges, portable equipment ...), it's recommended to test in monthly intervals.
- Pressing the test key "T" serves the only purpose of function testing the residual current device (RCD). This test does not make earthing resistance measurement (R_E), or proper checking of the earth conductor condition redundant, which must be performed separately.
- **Type -A:** Protects against special forms of residual pulsating DC which have not been smoothed.

Accessories:

Auxiliary switch for subsequent installation	ZP-IHK	286052
	ZP-WHK	286053
Tripping signal contact for subsequent installation	ZP-NHK	248437
Shunt trip release	ZP-ASA/..	248438, 248439
Switching interlock	IS/SPE-1TE	101911
Terminal cover 4-pole	Z-CV/SD-4P	178101

Technical Data

		FRBm6, FRBm4, 3+N-pole
Electrical		
Design according to		IEC/EN 61009
Current test marks as printed onto the device		
Tripping		line voltage-independent, instantaneous 250A (8/20μs), surge current-proof, N protected
Rated voltage	U_n	240/415V AC, 50Hz
Rated tripping current	$I_{\Delta n}$	30, 100, 300 mA
Rated non-tripping current	$I_{\Delta no}$	0.5 $I_{\Delta n}$
Sensitivity		AC and pulsating DC
Selectivity class		3
Rated breaking capacity	I_{cn}	
FRBm6		6 kA
FRBm4		4.5 kA
Rated current		6 - 32 A
Rated impulse withstand voltage	U_{imp}	4 kV (1.2/50μs)
Characteristic		B, C, D
Maximum back-up fuse (short circuit)		100 A gL (>10 kA)
Endurance		
electrical components		≥ 4,000 operating cycles
mechanical components		≥ 10,000 operating cycles
Mechanical		
Frame size		45 mm
Device height		80 mm
Device width		70 mm (4MU)
Mounting		3-position DIN rail clip, permits removal from existing busbar system
Degree of protection switch		IP20
Degree of protection, built-in		IP40
Upper and lower terminals		open mouthed/lift terminals
Terminal protection		finger and hand touch safe, VBG4, ÖVE-EN 6
Terminal capacity rigid solid/stranded wire		1 - 25 mm ²
Terminal torque		2 - 2.4 Nm
Busbar thickness		0.8 - 2 mm
Operation temperature		-25°C to +40°C
Storage- and transport temperature		-35°C to +60°C
Climatic conditions		acc. to IEC 68-2 (25..55°C / 90..95% RH)

Connection diagram

3+N-pole

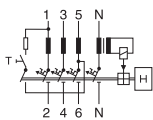

Dimensions (mm)

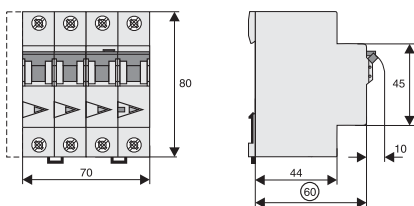

Tripping Characteristic FRBm. 3+N-pole, Characteristics B, C and D

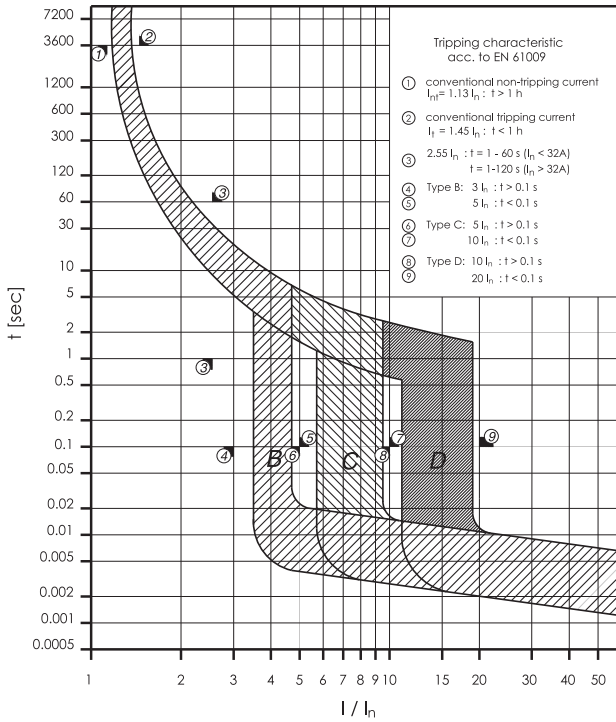

Internal Resistance FRBmM 3-pole

At room temperature (single pole)

I_n [A]	Type B			Type C			Type D		
	L1, L2 R* [mΩ]	L3 R* [mΩ]	N R* [mΩ]	L1, L2 R* [mΩ]	L3 R* [mΩ]	N R* [mΩ]	L1, L2 R* [mΩ]	L3 R* [mΩ]	N R* [mΩ]
6	-	-	-	34,3	28,2	28,8	34,3	28,0	29,7
10	-	-	-	19,3	15,3	18,1	19,7	15,3	15,3
13	11,8	12,6	12,2	11,9	12,7	9,1	9,9	10,4	8,9
16	9,8	9,3	7,8	9,5	8,8	6,6	9,8	9,2	6,8
20	-	-	-	6,5	5,9	5,5	6,6	6,1	5,5
25	-	-	-	4,3	3,7	3,5	-	-	-

* 50Hz

Power Loss at I_n FRBmM 3-pole

(entire unit)

I_n [A]	Type B	Type C	Type D
	P* [W]	P* [W]	P* [W]
6	-	4,8	4,8
10	-	8,2	7,8
13	10,2	9,4	7,7
16	11,6	10,9	11,2
20	-	11,8	12,0
25	-	11,6	-

* 50Hz and ambient temperature

Back-up Protection FRBm4/FRBm6

The up-stream protective devices will protect the down-stream FRBm4/FRBm6 up to the short-circuit current specified.

FRBm and NZM1

Short circuit currents in kA.

FRBm4/FRBm6-I _n /B,C,D.. +NZMB1(C1)(N1)(H1)-A...			
	U _e = 415 V		
	B	C	D
6	-	20	20
10	-	20	20
13	20	20	20
16	20	20	20
20	-	20	20
25	-	20	-

U_e = 415V: I_{cn} (FRBm4) = 4.5 kA (acc. to IEC/EN 61009)

U_e = 415V: I_{cu} (FRBm6) = 6 kA (acc. to IEC/EN 61009)

U_e = 400/415V: I_{cn} (NZMB1) = 25 kA (acc. to IEC/EN 60947-2)

U_e = 400/415V: I_{cn} (NZMC1) = 36 kA (acc. to IEC/EN 60947-2)

U_e = 400/415V: I_{cn} (NZMN1) = 50 kA (acc. to IEC/EN 60947-2)

U_e = 400/415V: I_{cn} (NZMH1) = 100 kA (acc. to IEC/EN 60947-2)

FRBm and NZM2

Short circuit currents in kA.

FRBm4/FRBm6-I _n /B,C,D.. +NZMB2(C2)(N2)(H2)-A...			
	U _e = 415 V		
	B	C	D
6	-	20	20
10	-	20	20
13	20	20	20
16	20	20	20
20	-	20	20
25	-	20	-

U_e = 415V: I_{cn} (FRBm4) = 4.5 kA (acc. to IEC/EN 61009)

U_e = 415V: I_{cu} (FRBm6) = 6 kA (acc. to IEC/EN 61009)

U_e = 400/415V: I_{cn} (NZMB2) = 25 kA (acc. to IEC/EN 60947-2)

U_e = 400/415V: I_{cn} (NZMC2) = 36 kA (acc. to IEC/EN 60947-2)

U_e = 400/415V: I_{cn} (NZMN2) = 50 kA (acc. to IEC/EN 60947-2)

U_e = 400/415V: I_{cn} (NZMH2) = 150 kA (acc. to IEC/EN 60947-2)

Add-on Residual Current Protection Unit FBSmV, Type AC and A

SG03613



- Combining this device with a top-quality miniature circuit breaker of Type FAZ (except FAZ-PN) will form a top-quality RCBO unit (combined RCD/MCB device)
- Draw-out connection bar locked in installation position
- For subsequent mounting onto 2-, 3-, 3+N- and 4-pole miniature circuit breakers FAZ
- Rated current 40 and 63 A
- 120 V Types

Add-on Residual Current Protection Unit FBSmV Type AC Conditionally surge-current-proof 250 A, Type AC

SG03513



2-pole

$I_n/I_{\Delta n}$ (A)	Type Designation	Article No.	Units per package
40/0.03	FBSmV-40/2/003	170177	1/20
40/0.03	FBSmV-40/2/003-400	180632	1/20
63/0.03	FBSmV-63/2/003	170178	1/20
63/0.03	FBSmV-63/2/003-400	180633	1/20
40/0.1	FBSmV-40/2/01	170179	1/20
63/0.1	FBSmV-63/2/01	170180	1/20
40/0.3	FBSmV-40/2/03	170181	1/20
63/0.3	FBSmV-63/2/03	170182	1/20
40/0.5	FBSmV-40/2/05	170183	1/20
63/0.5	FBSmV-63/2/05	170184	1/20
40/1	FBSmV-40/2/1	170185	1/20
63/1	FBSmV-63/2/1	170186	1/20

SG03713



3-pole

$I_n/I_{\Delta n}$ (A)	Type Designation	Article No.	Units per package
40/0.03	FBSmV-40/3/003	170187	1/20
63/0.03	FBSmV-63/3/003	170188	1/20
40/0.1	FBSmV-40/3/01	170189	1/20
63/0.1	FBSmV-63/3/01	170190	1/20
40/0.3	FBSmV-40/3/03	170191	1/20
63/0.3	FBSmV-63/3/03	170192	1/20
40/0.5	FBSmV-40/3/05	170193	1/20
63/0.5	FBSmV-63/3/05	170194	1/20
40/1	FBSmV-40/3/1	170195	1/20
63/1	FBSmV-63/3/1	170196	1/20

SG03613





4-pole

$I_n/I_{\Delta n}$ (A)	Type Designation	Article No.	Units per package
40/0.03	FBSmV-40/4/003	170197	1/13
63/0.03	FBSmV-63/4/003	170198	1/13
40/0.1	FBSmV-40/4/01	170199	1/13
63/0.1	FBSmV-63/4/01	170200	1/13
40/0.3	FBSmV-40/4/03	170201	1/13
63/0.3	FBSmV-63/4/03	170202	1/13
40/0.5	FBSmV-40/4/05	170203	1/13
63/0.5	FBSmV-63/4/05	170204	1/13
40/1	FBSmV-40/4/1	170205	1/13
63/1	FBSmV-63/4/1	170206	1/13



Add-on Residual Current Protection Unit FBSmV Type A

Sensitive to residual pulsating DC, conditionally surge current-proof 250 A, Type A





	$I_n/I_{\Delta n}$ (A)	Type Designation	Article No.	Units per package
2-pole				
SG03513 	40/0.03	FBSmV-40/2/003-A	170207	1/20
	40/0.03	FBSmV-40/2/003-A-120	180622	1/20
	40/0.03	FBSmV-40/2/003-A-400	180623	1/20
	63/0.03	FBSmV-63/2/003-A	170208	1/20
	63/0.03	FBSmV-63/2/003-A-120	180626	1/20
	63/0.03	FBSmV-63/2/003-A-400	180627	1/20
	40/0.1	FBSmV-40/2/01-A	170209	1/20
	63/0.1	FBSmV-63/2/01-A	170210	1/20
	40/0.3	FBSmV-40/2/03-A	170211	1/20
	40/0.3	FBSmV-40/2/03-A-120	180630	1/20
	63/0.3	FBSmV-63/2/03-A	170212	1/20
	63/0.3	FBSmV-63/2/03-A-120	180631	1/20
	40/0.5	FBSmV-40/2/05-A	170213	1/20
	63/0.5	FBSmV-63/2/05-A	170214	1/20
	40/1	FBSmV-40/2/1-A	170215	1/20
	63/1	FBSmV-63/2/1-A	170216	1/20
	3-pole			
SG03713 	40/0.03	FBSmV-40/3/003-A	170217	1/20
	40/0.03	FBSmV-40/3/003-A-230	180624	1/20
	63/0.03	FBSmV-63/3/003-A	170218	1/20
	63/0.03	FBSmV-63/3/003-A-230	180628	1/20
	40/0.1	FBSmV-40/3/01-A	170219	1/20
	63/0.1	FBSmV-63/3/01-A	170220	1/20
	40/0.3	FBSmV-40/3/03-A	170221	1/20
	63/0.3	FBSmV-63/3/03-A	170222	1/20
	40/0.5	FBSmV-40/3/05-A	170223	1/20
	63/0.5	FBSmV-63/3/05-A	170224	1/20
	40/1	FBSmV-40/3/1-A	170225	1/20
	63/1	FBSmV-63/3/1-A	170226	1/20
	4-pole			
SG03613 	40/0.03	FBSmV-40/4/003-A	170227	1/13
	40/0.03	FBSmV-40/4/003-A-230	180625	1/13
	63/0.03	FBSmV-63/4/003-A	170228	1/13
	63/0.03	FBSmV-63/4/003-A-230	180629	1/13
	40/0.1	FBSmV-40/4/01-A	170229	1/13
	63/0.1	FBSmV-63/4/01-A	170230	1/13
	40/0.3	FBSmV-40/4/03-A	170231	1/13
	63/0.3	FBSmV-63/4/03-A	170232	1/13
	40/0.5	FBSmV-40/4/05-A	170233	1/13
	63/0.5	FBSmV-63/4/05-A	170234	1/13
	40/1	FBSmV-40/4/1-A	170235	1/13
	63/1	FBSmV-63/4/1-A	170236	1/13

Add-on Residual Current Protection Unit FBSmV Type G Surge current-proof 3 kA, Type G (ÖVE E 8601)



	$I_n/I_{\Delta n}$ (A)	Type Designation	Article No.	Units per package
SG03513 	2-pole			
	40/0.03	FBSmV-40/2/003-G	170237	1/20
SG03713 	3-pole			
	40/0.03	FBSmV-40/3/003-G	170238	1/20
SG03613 	4-pole			
	40/0.03	FBSmV-40/4/003-G	170239	1/13

Add-on Residual Current Protection Unit FBSmV Type S Selective and surge current-proof 5 kA, Type S

	$I_n/I_{\Delta n}$ (A)	Type Designation	Article No.	Units per package
SG03513 	2-pole			
	40/0.1	FBSmV-40/2/01-S	170240	1/20
	63/0.1	FBSmV-63/2/01-S	170241	1/20
	40/0.3	FBSmV-40/2/03-S	170142	1/20
	63/0.3	FBSmV-63/2/03-S	170143	1/20
	40/1	FBSmV-40/2/1-S	170144	1/20
	63/1	FBSmV-63/2/1-S	170145	1/20
SG03713 	3-pole			
	40/0.1	FBSmV-40/3/01-S	170146	1/20
	63/0.1	FBSmV-63/3/01-S	170147	1/20
	40/0.3	FBSmV-40/3/03-S	170148	1/20
	63/0.3	FBSmV-63/3/03-S	170149	1/20
	40/1	FBSmV-40/3/1-S	170150	1/20
	63/1	FBSmV-63/3/1-S	170151	1/20
SG03613 	4-pole			
	40/0.1	FBSmV-40/4/01-S	170152	1/13
	63/0.1	FBSmV-63/4/01-S	170153	1/13
	40/0.3	FBSmV-40/4/03-S	170154	1/13
	63/0.3	FBSmV-63/4/03-S	170155	1/13
	40/1	FBSmV-40/4/1-S	170156	1/13
	63/1	FBSmV-63/4/1-S	170157	1/13

Add-on Residual Current Protection Unit FBSmV Type S/A

Selective + surge current-proof typ. 5 kA, sensitive to residual pulsating DC, Type S/A 

	$I_n/I_{\Delta n}$ (A)	Type Designation	Article No.	Units per package
2-pole				
 <p>SG03513</p>	40/0,1	FBSmV-40/2/01-S/A	170158	1/20
	63/0,1	FBSmV-63/2/01-S/A	170159	1/20
	40/0,3	FBSmV-40/2/03-S/A	170160	1/20
	63/0,3	FBSmV-63/2/03-S/A	170161	1/20
3-pole				
 <p>SG03713</p>	40/0,1	FBSmV-40/3/01-S/A	170162	1/20
	63/0,1	FBSmV-63/3/01-S/A	170163	1/20
	40/0,3	FBSmV-40/3/03-S/A	170164	1/20
	63/0,3	FBSmV-63/3/03-S/A	170165	1/20
4-pole				
 <p>SG03613</p>	40/0,1	FBSmV-40/4/01-S/A	170166	1/13
	63/0,1	FBSmV-63/4/01-S/A	170167	1/13
	40/0,3	FBSmV-40/4/03-S/A	170168	1/13
	63/0,3	FBSmV-63/4/03-S/A	170169	1/13

Specifications | Add-on Residual Current Protection Unit FBSmV

Description

- Add-on residual current unit
- Line voltage-independent tripping
- By combining this device with a top-quality miniature circuit breaker type FAZ (except FAZ-PN) a top-quality RCBO unit (combined RCD/MCB device) is formed
- Rated current 40 and 63 A
- Permits combinations with a variety of characteristics thanks to the different rated currents and characteristics of the FAZ-miniature circuit breakers which can be connected
- Comprehensive range of accessories suitable for subsequent installation onto FAZ
- The test key "T" must be pressed every 6 months. The system operator must be informed of this obligation and his responsibility in a way that can be proven. Under special conditions (e.g. damply and/or dusty environments, environments with polluting and/or corroding conditions, environments with large temperature fluctuations, installations with a risk of overvoltages due to switching of equipment and/or atmospheric discharges, portable equipment ...), it's recommended to test in monthly intervals.
- Pressing the test key "T" serves the only purpose of function testing the residual current device (RCD). This test does not make earthing resistance measurement (R_E), or proper checking of the earth conductor condition redundant, which must be performed separately.
- **Type -A:** Protects against special forms of residual pulsating DC which have not been smoothed.
- **Type -G:** High reliability against unwanted tripping. Compulsory for any circuit where personal injury or damage to property may occur in case of unwanted tripping (ÖVE/ÖNORM E 8001-1 § 12.1.6).
- **Type -S:** Selective residual current device sensitive to AC, Type -S. Compulsory for systems with surge arresters downstream of the RCD (ÖVE/ÖNORM E 8001-1 § 12.1.5).
- **Type -S/A:** Additionally protects against special forms of residual pulsating DC which have not been smoothed.

Accessories:

Cover cap for draw-out connection bar	included
Slotted one-way cheese head screw	included

Accessories (on FAZ):

Auxiliary switch for subsequent installation	ZP-IHK	286052	
	ZP-WHK	286053	
Tripping signal contact for subsequent installation	ZP-NHK	248437	
Automatic restarting device	Z-FW/LP	248296	
	Z-FW-LPD	265244	
	Remote control	Z-FW-MO	284730
	Pre-mounted sets	Z-FW-LP/MO	290171
		Z-FW-LPD/MO	290172
	Remote testing module	Z-FW/001	248297
		Z-FW/003	248298
		Z-FW/010	248299
Z-FW/030		248300	
	Z-FW/050	248301	
Shunt trip release	ZP-ASA/..	248438, 248439	
Undervoltage release	Z-USA	258288, 248289, 248290	
	Z-USD	248292, 248291	
Switching interlock	IS/SPE-1TE	101911	
Terminal cover			
1-pole	Z-TC/MCB-1P	178102	
2-pole	Z-TC/SD-2P	178099	
3-pole	Z-TC/SD-3P	178100	
4-pole	Z-TC/SD-4P	178101	

Technical Data

FBSmV	
Electrical	
Design according to	IEC/EN 61009
Current test marks as printed onto the device	
Tripping	instantaneous 250A (8/20 μ s), surge current-proof
Type G	10 ms delay 3kA (8/20 μ s), surge current-proof
Type S	40 ms delay 5kA (8/20 μ s) with selective disconnecting function, surge current-proof
Rated voltage	U_n 240/415V AC
Limits operation voltage test circuit	
2-pole, 30mA	196-264 V~
2-pole, 30mA-120	102-132 V~
2-pole, 30mA-400	340-456 V~
2-pole, 100, 300, 500, 1000mA	196-456 V~
3-pole, 30mA	340-456 V~
3-pole, 30mA-230	196-264 V~
3-pole, 100, 300, 500, 1000mA	196-456 V~
4-pole, 30mA	340-456 V~
4-pole, 30mA-230	196-264 V~
4-pole, 100, 300, 500, 1000mA	196-456 V~
Rated frequency	50 Hz
Rated tripping current	$I_{\Delta n}$ 30, 100, 300, 500, 1000 mA
Rated non-tripping current	$I_{\Delta no}$ 0.5 $I_{\Delta n}$
Sensitivity	AC and pulsating DC
Rated current	I_n ≤ 40 A, ≤ 63 A
Service short circuit breaking capacity	I_{cs} same as connected FAZ
Rated breaking capacity	I_{en} same as connected FAZ
Mechanical	
Frame size	45 mm
Device height	90 mm
Device width	70 mm (2p), 107.5 mm (3p), 125 mm (4p)
Mounting	fix mounted onto FAZ
Degree of protection switch	IP20
Degree of protection, built-in	IP40
Fastening screw	M2.5 (slotted one-way cheese head screw)
Screw head breaking torque	> 0.6 Nm
Upper and lower terminals	lift terminals
Terminal screws	M5 (combined Philips/standard head screws according to DIN7962-Z2, Pozidrive)
Terminal protection	finger and hand touch safe, BGV A3, ÖVE-EN 6
Terminal capacity	
Rigid conductors	1 x (1 - 25) mm ²
Flexible conductors (with wire end sleeve)	1 x (0.75 - 16) mm ²
Busbar thickness	0.8 - 2 mm
Ambient temperature range	-25°C to +40°C
Storage- and transport temperature	-35°C to +60°C
Resistance to climatic conditions	25-55°C/90-95% relative humidity acc. to IEC 60068-2

Connection diagram

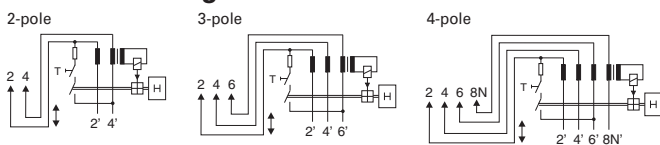

Dimensions (mm)

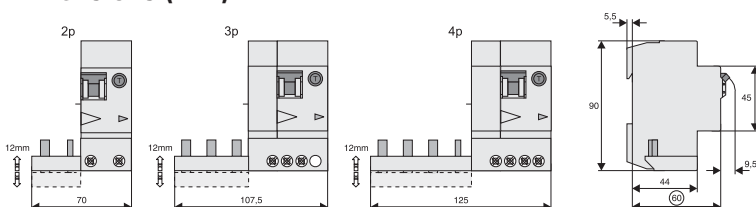

Add-on Residual Current Protection Unit FBHmV, Type AC and A



SG03913



- By combining this device with a top-quality miniature circuit breaker of type AZ a top-quality RCBO unit (combined RCD/MCB device) is formed.
- Add-on residual current unit (screw connection) for 80 or 125 A (2-pole and 4-pole)
- High flexibility and ease of installation thanks to variable wiring
- Free selection of main power supply
- Auxiliary switch 1 make contact included as standard in all FBHmV versions
- Permits combinations with a variety of characteristics thanks to the different rated currents and characteristics of the miniature circuit breakers AZ which can be connected
- For commercial and industry applications
- For subsequent mounting onto 2, 3, 3+N and 4-pole-miniature circuit breakers AZ
- The screw connection to the AZ-device can be unscrewed at any time. Consequently, in case of modifications of the systems to be protected, the installation can be adapted to new requirements at any time.



Add-on Residual Current Protection Unit FBHmV Type AC

Conditionally surge-current-proof 250 A, Type AC 

	$I_n/I_{\Delta n}$ (A)	Type Designation	Article No.	Units per package
SG03813 	2-pole			
	80/0.03	FBHmV-80/2/003	170266	1/4
	125/0.03	FBHmV-125/2/003	170242	1/4
	80/0.3	FBHmV-80/2/03	170243	1/4
	125/0.3	FBHmV-125/2/03	170244	1/4
	80/0.5	FBHmV-80/2/05	170245	1/4
	125/0.5	FBHmV-125/2/05	170246	1/4
	80/1	FBHmV-80/2/1	170247	1/4
125/1	FBHmV-125/2/1	170248	1/4	
SG04013 	4-pole			
	80/0.03	FBHmV-80/4/003	170249	1/4
	125/0.03	FBHmV-125/4/003	170250	1/4
	80/0.3	FBHmV-80/4/03	170251	1/4
	125/0.3	FBHmV-125/4/03	170252	1/4
	80/0.5	FBHmV-80/4/05	170253	1/4
	125/0.5	FBHmV-125/4/05	170254	1/4
	80/1	FBHmV-80/4/1	170255	1/4
125/1	FBHmV-125/4/1	170256	1/4	

Add-on Residual Current Protection Unit FBHmV Type A

Sensitive to residual pulsating DC, conditionally surge current-proof 250 A, Type A 

	$I_n/I_{\Delta n}$ (A)	Type Designation	Article No.	Units per package
SG03813 	2-pole			
	80/0.03	FBHmV-80/2/003-A	170257	1/4
	125/0.03	FBHmV-125/2/003-A	170258	1/4
	80/0.3	FBHmV-80/2/03-A	170259	1/4
	125/0.3	FBHmV-125/2/03-A	170260	1/4
	80/0.5	FBHmV-80/2/05-A	170261	1/4
	125/0.5	FBHmV-125/2/05-A	170262	1/4
	80/1	FBHmV-80/2/1-A	170263	1/4
125/1	FBHmV-125/2/1-A	170264	1/4	
SG03913 	4-pole			
	80/0.03	FBHmV-80/4/003-A	170265	1/4
	125/0.03	FBHmV-125/4/003-A	170130	1/4
	80/0.3	FBHmV-80/4/03-A	170131	1/4
	125/0.3	FBHmV-125/4/03-A	170132	1/4
	80/0.5	FBHmV-80/4/05-A	170133	1/4
	125/0.5	FBHmV-125/4/05-A	170134	1/4
	80/1	FBHmV-80/4/1-A	170135	1/4
125/1	FBHmV-125/4/1-A	170136	1/4	

Add-on Residual Current Protection Unit FBHmV Type S/A

Selective + surge current-proof 5 kA, Type S/A 

SG04113



2-pole

$I_n/I_{\Delta n}$ (A)	Type Designation	Article No.	Units per package
80/0.3	FBHmV-80/2/03-S/A	170137	1/4
125/0.3	FBHmV-125/2/03-S/A	170138	1/4
80/0.5	FBHmV-80/2/05-S/A	170139	1/4
125/0.5	FBHmV-125/2/05-S/A	170140	1/4
80/1	FBHmV-80/2/1-S/A	170141	1/4
125/1	FBHmV-125/2/1-S/A	170170	1/4

SG03913



4-pole

$I_n/I_{\Delta n}$ (A)	Type Designation	Article No.	Units per package
80/0.3	FBHmV-80/4/03-S/A	170171	1/4
125/0.3	FBHmV-125/4/03-S/A	170172	1/4
80/0.5	FBHmV-80/4/05-S/A	170173	1/4
125/0.5	FBHmV-125/4/05-S/A	170174	1/4
80/1	FBHmV-80/4/1-S/A	170175	1/4
125/1	FBHmV-125/4/1-S/A	170176	1/4

Specifications | Add-on Residual Current Protection Unit FBHmV

Description

- By combination with miniature circuit breaker AZ => RCBO-Unit (MCCB)
- Add-on residual current unit (screw connection) for 80 or 125 A (2-pole and 4-pole)
- High flexibility and ease of installation thanks to variable wiring (400 mm flexible connection wires 2p = 2 units, 4p = 4 units included in the set)
- Free selection of main power supply
- Auxiliary switch 1 NO included as standard in all FBHmV versions
- Permits combinations with a variety of characteristics thanks to the different rated currents and characteristics of the miniature circuit breakers AZ which can be connected
- For trade and industry applications
- For subsequent mounting onto 2, 3, 3+N and 4-pole-miniature circuit breakers AZ
- Toggle (serves as switch position- and tripping indicator)
- The screw connection to the AZ-device can be unscrewed at any time. Consequently, in case of modifications of the systems to be protected, the installation can be adapted to new requirements at any time.
- The test key "T" must be pressed every 6 months. The system operator must be informed of this obligation and his responsibility in a way that can be proven. Under special conditions (e.g. damply and/or dusty environments, environments with polluting and/or corroding conditions, environments with large temperature fluctuations, installations with a risk of overvoltages due to switching of equipment and/or atmospheric discharges, portable equipment ...), it's recommended to test in monthly intervals.
- Pressing the test key "T" serves the only purpose of function testing the residual current device (RCD). This test does not make earthing resistance measurement (R_E), or proper checking of the earth conductor condition redundant, which must be performed separately.

Accessories:

Flexible connection wires (connection to AZ) are included in the standard set:

	2-pole 80A	2 x 16mm ² (400mm each)
	4-pole 80A	4 x 16mm ² (400mm each)
	2-pole 125A	2 x 35mm ² (400mm each)
	4-pole 125A	4 x 35mm ² (400mm each)
Shunt trip release	Z-BAASA/24	248444
	Z-BAASA/230	248445

Technical Data

		FBHmV
Electrical current flow paths		
Design according to		IEC/EN 61009
Current test marks as printed onto the device		
Tripping		instantaneous 250A (8/20 μ s), surge current-proof
Type S		40 ms delay 5kA (8/20 μ s) with selective disconnecting function, surge current-proof
Rated voltage	U_n	240/415V AC
Limits operation voltage test circuit		
2-pole		196-264 V~
4-pole, 30mA		196-264 V~
4-pole, 100, 300, 500, 1000mA		196-456 V~
Rated frequency		50 Hz
Rated tripping current	$I_{\Delta n}$	30, 300, 500, 1000 mA
Rated non-tripping current	$I_{\Delta no}$	0.5 $I_{\Delta n}$
Sensitivity		AC and pulsating DC
Rated current	I_n	80, 125 A
Rated service short circuit breaking capacity	I_{cn}	same as connected AZ
Rated ultimate circuit breaking capacity	I_{cu}	same as connected AZ
Rated impulse withstand voltage	U_{imp}	4 kV (1.2/50 μ s)
Endurance		
electrical components		
80A		$\geq 1,500$ operating cycles
125A		$\geq 1,000$ operating cycles
mechanical components		
80A		$\geq 10,000$ operating cycles
125A		$\geq 8,000$ operating cycles
Electrical Auxiliary Contact		
Utilisation category AC15		
Rated voltage	U_e	250 V AC
Rated operational current	I_e	16 A AC
Mechanical		
Frame size		45 mm
Device height		90 mm
Device width		95 mm (5.5MU)
Depth of central body		60 mm
Mounting		screwed onto AZ 2-, 3-, 4-pole; Z-BHASA
Degree of protection switch		IP20
Degree of protection, built-in		IP40
Upper and lower terminals		lift terminals
Terminal protection		finger and hand touch safe, BGV A3, ÖVE-EN 6
Terminal capacity		
Main conductor		2.5 - 50 mm ²
Auxiliary switch		1 - 25 mm ²
Ambient temperature range		-25°C to +40°C
Storage- and transport temperature		-35°C to +60°C
Resistance to climatic conditions		25-55°C/90-95% relative humidity acc. to IEC 60068-2

Connection diagram

2-pole

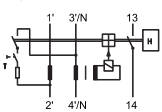

4-pole

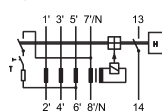

Dimensions (mm)

FBHmV/2p + AZ/2p

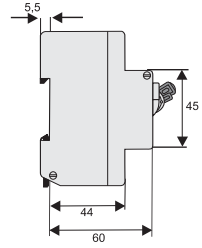
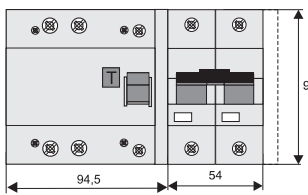

FBHmV/4p + AZ/3p+N

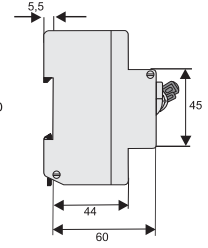
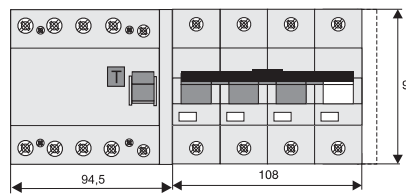

FBHmV/4p + AZ/3p

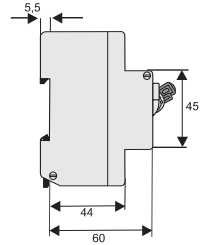
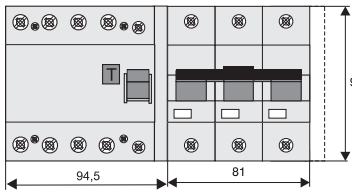

FBHmV/4p + AZ/4p

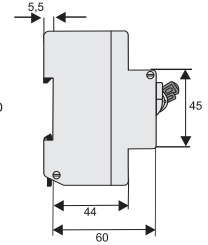
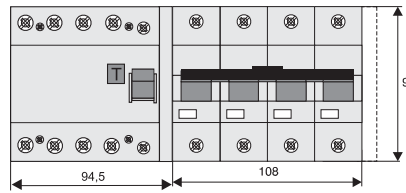

Wiring options

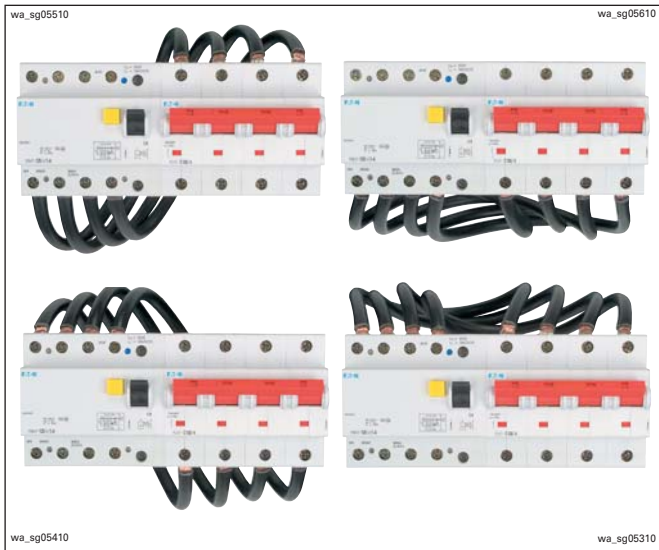

Mounting FBHmV + AZ

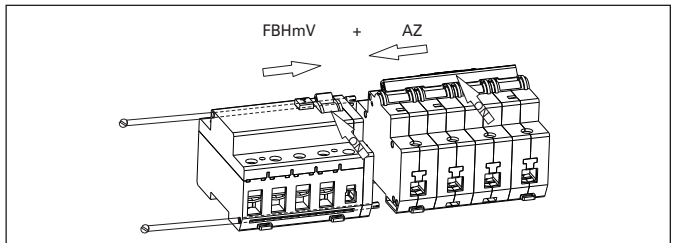

Connection FBHmV/4p + AZ/3p

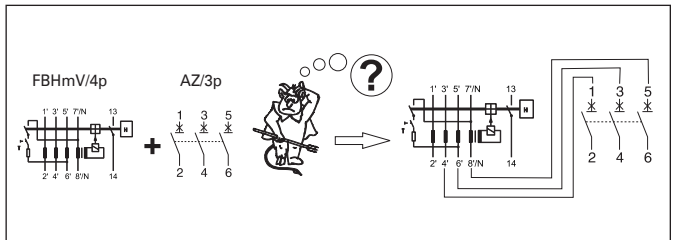

Mounting arrangement residual current protection unit - shunt trip release - miniature circuit breaker - auxiliary contact

FBHmV-2-pole

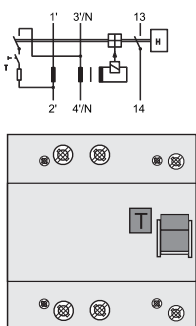

FBHmV-4-pole

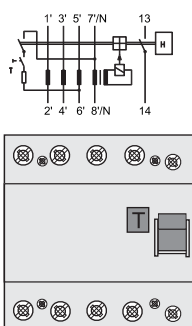

Z-BHASA

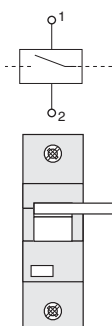

FBHmV-3+N-pole

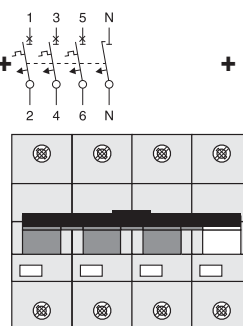

Z-LHK

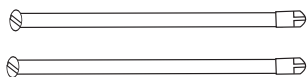
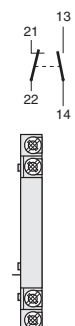

Specifications | Accessories for FBHmV - Shunt Trip Release Z-BHASA

Description

- Can be mounted subsequently
- Contact position indicator red - green
- Marking labels can be fitted
- Wide operational voltage range
- Sufficient power of extra low voltage source must be ensured Z-BHASA/24: min. 90 VA
- Screws for mounting included FBHmV => BHASA => AZ

	Z-BHASA/24	Z-BHASA/230
Electrical		
Minimum pulse duration	15 ms	10 ms
Internal resistance	2 Ω	130 Ω
Duty	100%	100%
Tripping time	< 20 ms	< 20 ms
Peak withstand voltage (1.2/50µs)	2 kV	2 kV
Endurance		
electrical components	≥ 4,000 operating cycles	
mechanical components	≥ 4,000 operating cycles	
AC voltage range:		
Responding limit	8 V	70 V
Operational voltage range	12-60 V	110-415 V
Maximum current consumption during switch-on	1.4-7 A	3.4 A (at 230V)
Current flow time at max. current consumption	4.0 ms	4.5 ms
DC voltage range:		
Responding limit	11 V	90 V
DC voltage range	12-60 V	110-230 V
Maximum current consumption during switch-on	1.7 A typ.	1.7 A typ.
Current flow time at max. current consumption	2 ms	4 ms
Mechanical		
Frame size	45 mm	45 mm
Device height	90 mm	90 mm
Device width	27 mm	27 mm
Mounting	quick fastening on DIN rail IEC/EN 60715	
Degree of protection switch	IP20	IP20
Degree of protection, built-in	IP40	IP40
Upper and lower terminals	lift terminals	lift terminals
Terminal protection	finger and hand touch safe, BGV A3, ÖVE-EN 6	
Terminal capacity	2.5 - 30 mm ²	2.5 - 30 mm ²
Fastening torque of terminal screws	4 Nm	4 Nm

Connection diagram

2-pole

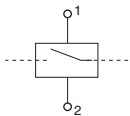

Dimensions (mm)

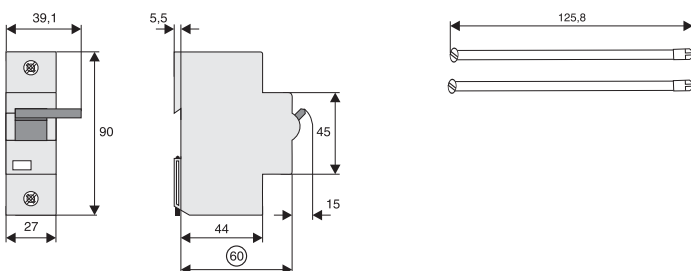

Miniature Circuit Breakers FAZ, FAZ-PN, FAZ-HS

SG55812



FAZ

- High-quality miniature circuit breakers for industrial applications and residential applications
- Contact position indicator red - green
- Guide for secure terminal connection
- 3-position DIN rail clip, permits removal from existing busbar system
- Comprehensive range of accessories suitable for subsequent installation
- Rated currents up to 63 A
- Tripping characteristics B, C, D, K, S, Z
- Rated breaking capacity up to 15 kA according to IEC/EN 60947-2

FAZ-PN

- Tripping characteristic B
- Rated breaking capacity up to 6 kA according to IEC/EN 60898-1
- Module width 1MU (1+N-poles)

FAZ-HS

- Tripping characteristic B
- Rated breaking capacity up to 10 kA according to IEC/EN 60898-1
- 1- and 2-poles available

FAZ Miniature Circuit Breakers (MCBs)

Characteristic B

	Rated current I_n (A)	Rated voltage (V)	Breaking capacity acc. to IEC/EN 60947-2 (kA)	Rated voltage UL1077 (V)	Breaking capacity acc. to UL1077 (kA)	Type Designation	Article No.	Units per package
1-pole								
1	240/415	15	277	10		FAZ-B1/1	278520	12/120
1.5	240/415	15	277	10		FAZ-B1,5/1	278521	12/120
1.6	240/415	15	277	10		FAZ-B1,6/1	278522	12/120
2	240/415	15	277	10		FAZ-B2/1	278523	12/120
2.5	240/415	15	277	10		FAZ-B2,5/1	278524	12/120
3	240/415	15	277	10		FAZ-B3/1	278525	12/120
3.5	240/415	15	277	10		FAZ-B3,5/1	278526	12/120
4	240/415	15	277	10		FAZ-B4/1	278527	12/120
5	240/415	15	277	10		FAZ-B5/1	278528	12/120
6	240/415	15	277	10		FAZ-B6/1	278529	12/120
8	240/415	15	277	10		FAZ-B8/1	278530	12/120
10	240/415	15	277	10		FAZ-B10/1	278531	12/120
12	240/415	15	277	10		FAZ-B12/1	278532	12/120
13	240/415	15	277	10		FAZ-B13/1	278533	12/120
15	240/415	15	277	10		FAZ-B15/1	278534	12/120
16	240/415	15	277	10		FAZ-B16/1	278535	12/120
20	240/415	15	277	10		FAZ-B20/1	278536	12/120
25	240/415	15	277	10		FAZ-B25/1	278537	12/120
32	240/415	15	277	10		FAZ-B32/1	278538	12/120
40	240/415	15	277	5		FAZ-B40/1	278539	12/120
50	240/415	15	277	5		FAZ-B50/1	278540	12/120
63	240/415	15	277	5		FAZ-B63/1	278541	12/120

SG53112



SG56612



1+N-pole								
1	240	15	277	10		FAZ-B1/1N	278633	1/60
1.5	240	15	277	10		FAZ-B1,5/1N	278634	1/60
1.6	240	15	277	10		FAZ-B1,6/1N	278635	1/60
2	240	15	277	10		FAZ-B2/1N	278636	1/60
2.5	240	15	277	10		FAZ-B2,5/1N	278637	1/60
3	240	15	277	10		FAZ-B3/1N	278638	1/60
3.5	240	15	277	10		FAZ-B3,5/1N	278639	1/60
4	240	15	277	10		FAZ-B4/1N	278640	1/60
5	240	15	277	10		FAZ-B5/1N	278641	1/60
6	240	15	277	10		FAZ-B6/1N	278642	1/60
8	240	15	277	10		FAZ-B8/1N	278643	1/60
10	240	15	277	10		FAZ-B10/1N	278644	1/60
12	240	15	277	10		FAZ-B12/1N	278645	1/60
13	240	15	277	10		FAZ-B13/1N	278646	1/60
15	240	15	277	10		FAZ-B15/1N	278647	1/60
16	240	15	277	10		FAZ-B16/1N	278648	1/60
20	240	15	277	10		FAZ-B20/1N	278649	1/60
25	240	15	277	10		FAZ-B25/1N	278650	1/60
32	240	15	277	10		FAZ-B32/1N	278651	1/60
40	240	15	277	5		FAZ-B40/1N	278652	1/60
50	240	15	277	5		FAZ-B50/1N	278653	1/60
63	240	15	277	5		FAZ-B63/1N	278654	1/60

SG55112



Rated current I_n (A)	Rated voltage (V)	Breaking capacity acc. to IEC/EN 60947-2 (kA)	Rated voltage UL1077 (V)	Breaking capacity acc. to UL1077 (kA)	Type Designation	Article No.	Units per package
----------------------------	----------------------	---	--------------------------------	--	---------------------	-------------	-------------------------

2-pole

1	415	15	480Y/277	10	FAZ-B1/2	278719	1/60
1.5	415	15	480Y/277	10	FAZ-B1,5/2	278720	1/60
1.6	415	15	480Y/277	10	FAZ-B1,6/2	278721	1/60
2	415	15	480Y/277	10	FAZ-B2/2	278722	1/60
2.5	415	15	480Y/277	10	FAZ-B2,5/2	278723	1/60
3	415	15	480Y/277	10	FAZ-B3/2	278724	1/60
3.5	415	15	480Y/277	10	FAZ-B3,5/2	278725	1/60
4	415	15	480Y/277	10	FAZ-B4/2	278726	1/60
5	415	15	480Y/277	10	FAZ-B5/2	278727	1/60
6	415	15	480Y/277	10	FAZ-B6/2	278728	1/60
8	415	15	480Y/277	10	FAZ-B8/2	278729	1/60
10	415	15	480Y/277	10	FAZ-B10/2	278730	1/60
12	415	15	480Y/277	10	FAZ-B12/2	278731	1/60
13	415	15	480Y/277	10	FAZ-B13/2	278732	1/60
15	415	15	480Y/277	10	FAZ-B15/2	278733	1/60
16	415	15	480Y/277	10	FAZ-B16/2	278734	1/60
20	415	15	480Y/277	10	FAZ-B20/2	278735	1/60
25	415	15	480Y/277	10	FAZ-B25/2	278736	1/60
32	415	15	480Y/277	10	FAZ-B32/2	278737	1/60
40	415	15	480Y/277	5	FAZ-B40/2	278738	1/60
50	415	15	480Y/277	5	FAZ-B50/2	278739	1/60
63	415	15	480Y/277	5	FAZ-B63/2	278740	1/60

SG53412



3-pole

1	415	15	480Y/277	10	FAZ-B1/3	278832	1/40
1.5	415	15	480Y/277	10	FAZ-B1,5/3	278833	1/40
1.6	415	15	480Y/277	10	FAZ-B1,6/3	278834	1/40
2	415	15	480Y/277	10	FAZ-B2/3	278835	1/40
2.5	415	15	480Y/277	10	FAZ-B2,5/3	278836	1/40
3	415	15	480Y/277	10	FAZ-B3/3	278837	1/40
3.5	415	15	480Y/277	10	FAZ-B3,5/3	278838	1/40
4	415	15	480Y/277	10	FAZ-B4/3	278839	1/40
5	415	15	480Y/277	10	FAZ-B5/3	278840	1/40
6	415	15	480Y/277	10	FAZ-B6/3	278841	1/40
8	415	15	480Y/277	10	FAZ-B8/3	278842	1/40
10	415	15	480Y/277	10	FAZ-B10/3	278843	1/40
12	415	15	480Y/277	10	FAZ-B12/3	278844	1/40
13	415	15	480Y/277	10	FAZ-B13/3	278845	1/40
15	415	15	480Y/277	10	FAZ-B15/3	278846	1/40
16	415	15	480Y/277	10	FAZ-B16/3	278847	1/40
20	415	15	480Y/277	10	FAZ-B20/3	278848	1/40
25	415	15	480Y/277	10	FAZ-B25/3	278849	1/40
32	415	15	480Y/277	10	FAZ-B32/3	278850	1/40
40	415	15	480Y/277	5	FAZ-B40/3	278851	1/40
50	415	15	480Y/277	5	FAZ-B50/3	278852	1/40
63	415	15	480Y/277	5	FAZ-B63/3	278853	1/40

SG55712



Rated current I_n (A)	Rated voltage (V)	Breaking capacity acc. to IEC/EN 60947-2 (kA)	Rated voltage UL1077 (V)	Breaking capacity acc. to UL1077 (kA)	Type Designation	Article No.	Units per package
----------------------------	----------------------	---	--------------------------------	--	---------------------	-------------	-------------------------

3+N-pole

1	415	15	480Y/277	10	FAZ-B1/3N	278934	1/30
1.5	415	15	480Y/277	10	FAZ-B1,5/3N	278935	1/30
1.6	415	15	480Y/277	10	FAZ-B1,6/3N	278936	1/30
2	415	15	480Y/277	10	FAZ-B2/3N	278937	1/30
2.5	415	15	480Y/277	10	FAZ-B2,5/3N	278938	1/30
3	415	15	480Y/277	10	FAZ-B3/3N	278939	1/30
3.5	415	15	480Y/277	10	FAZ-B3,5/3N	278940	1/30
4	415	15	480Y/277	10	FAZ-B4/3N	278941	1/30
5	415	15	480Y/277	10	FAZ-B5/3N	278942	1/30
6	415	15	480Y/277	10	FAZ-B6/3N	278943	1/30
8	415	15	480Y/277	10	FAZ-B8/3N	278944	1/30
10	415	15	480Y/277	10	FAZ-B10/3N	278945	1/30
12	415	15	480Y/277	10	FAZ-B12/3N	278946	1/30
13	415	15	480Y/277	10	FAZ-B13/3N	278947	1/30
15	415	15	480Y/277	10	FAZ-B15/3N	278948	1/30
16	415	15	480Y/277	10	FAZ-B16/3N	278949	1/30
20	415	15	480Y/277	10	FAZ-B20/3N	278950	1/30
25	415	15	480Y/277	10	FAZ-B25/3N	278951	1/30
32	415	15	480Y/277	10	FAZ-B32/3N	278952	1/30
40	415	15	480Y/277	5	FAZ-B40/3N	278953	1/30
50	415	15	480Y/277	5	FAZ-B50/3N	278954	1/30
63	415	15	480Y/277	5	FAZ-B63/3N	278955	1/30

SG55812



4-pole

1	415	15	480Y/277	10	FAZ-B1/4	279020	1/30
1.5	415	15	480Y/277	10	FAZ-B1,5/4	279021	1/30
1.6	415	15	480Y/277	10	FAZ-B1,6/4	279022	1/30
2	415	15	480Y/277	10	FAZ-B2/4	279023	1/30
2.5	415	15	480Y/277	10	FAZ-B2,5/4	279024	1/30
3	415	15	480Y/277	10	FAZ-B3/4	279025	1/30
3.5	415	15	480Y/277	10	FAZ-B3,5/4	279026	1/30
4	415	15	480Y/277	10	FAZ-B4/4	279027	1/30
5	415	15	480Y/277	10	FAZ-B5/4	279028	1/30
6	415	15	480Y/277	10	FAZ-B6/4	279029	1/30
8	415	15	480Y/277	10	FAZ-B8/4	279030	1/30
10	415	15	480Y/277	10	FAZ-B10/4	279031	1/30
12	415	15	480Y/277	10	FAZ-B12/4	279032	1/30
13	415	15	480Y/277	10	FAZ-B13/4	279033	1/30
15	415	15	480Y/277	10	FAZ-B15/4	279034	1/30
16	415	15	480Y/277	10	FAZ-B16/4	279035	1/30
20	415	15	480Y/277	10	FAZ-B20/4	279036	1/30
25	415	15	480Y/277	10	FAZ-B25/4	279037	1/30
32	415	15	480Y/277	10	FAZ-B32/4	279038	1/30
40	415	15	480Y/277	5	FAZ-B40/4	279039	1/30
50	415	15	480Y/277	5	FAZ-B50/4	279040	1/30
63	415	15	480Y/277	5	FAZ-B63/4	279041	1/30

FAZ Miniature Circuit Breakers (MCBs)

Characteristic C

	Rated current I_n (A)	Rated voltage (V)	Breaking capacity acc. to IEC/EN 60947-2 (kA)	Rated voltage UL1077 (V)	Breaking capacity acc. to UL1077 (kA)	Type Designation	Article No.	Units per package
1-pole								
0.16	240/415	15	277	5		FAZ-C0,16/1	278542	12/120
0.25	240/415	15	277	5		FAZ-C0,25/1	278543	12/120
0.5	240/415	15	277	10		FAZ-C0,5/1	278544	12/120
0.75	240/415	15	277	10		FAZ-C0,75/1	278545	12/120
1	240/415	15	277	10		FAZ-C1/1	278546	12/120
1.5	240/415	15	277	10		FAZ-C1,5/1	278547	12/120
1.6	240/415	15	277	10		FAZ-C1,6/1	278548	12/120
2	240/415	15	277	10		FAZ-C2/1	278549	12/120
2.5	240/415	15	277	10		FAZ-C2,5/1	278550	12/120
3	240/415	15	277	10		FAZ-C3/1	278551	12/120
3.5	240/415	15	277	10		FAZ-C3,5/1	278552	12/120
4	240/415	15	277	10		FAZ-C4/1	278553	12/120
5	240/415	15	277	10		FAZ-C5/1	278554	12/120
6	240/415	15	277	10		FAZ-C6/1	278555	12/120
8	240/415	15	277	10		FAZ-C8/1	278556	12/120
10	240/415	15	277	10		FAZ-C10/1	278557	12/120
12	240/415	15	277	10		FAZ-C12/1	278558	12/120
13	240/415	15	277	10		FAZ-C13/1	278559	12/120
15	240/415	15	277	10		FAZ-C15/1	278560	12/120
16	240/415	15	277	10		FAZ-C16/1	278561	12/120
20	240/415	15	277	10		FAZ-C20/1	278562	12/120
25	240/415	15	277	10		FAZ-C25/1	278563	12/120
32	240/415	15	277	10		FAZ-C32/1	278564	12/120
40	240/415	15	277	5		FAZ-C40/1	278565	12/120
50	240/415	15	277	5		FAZ-C50/1	278566	12/120
63	240/415	15	277	5		FAZ-C63/1	278567	12/120

SG53112



SG55612



1+N-pole

0.16	240	15	277	5		FAZ-C0,16/1N	278655	1/60
0.25	240	15	277	5		FAZ-C0,25/1N	278656	1/60
0.5	240	15	277	10		FAZ-C0,5/1N	278657	1/60
0.75	240	15	277	10		FAZ-C0,75/1N	278658	1/60
1	240	15	277	10		FAZ-C1/1N	278659	1/60
1.5	240	15	277	10		FAZ-C1,5/1N	278660	1/60
1.6	240	15	277	10		FAZ-C1,6/1N	278661	1/60
2	240	15	277	10		FAZ-C2/1N	278662	1/60
2.5	240	15	277	10		FAZ-C2,5/1N	278663	1/60
3	240	15	277	10		FAZ-C3/1N	278664	1/60
3.5	240	15	277	10		FAZ-C3,5/1N	278665	1/60
4	240	15	277	10		FAZ-C4/1N	278666	1/60
5	240	15	277	10		FAZ-C5/1N	278667	1/60
6	240	15	277	10		FAZ-C6/1N	278668	1/60
8	240	15	277	10		FAZ-C8/1N	278669	1/60
10	240	15	277	10		FAZ-C10/1N	278670	1/60
12	240	15	277	10		FAZ-C12/1N	278671	1/60
13	240	15	277	10		FAZ-C13/1N	278672	1/60
15	240	15	277	10		FAZ-C15/1N	278673	1/60
16	240	15	277	10		FAZ-C16/1N	278674	1/60
20	240	15	277	10		FAZ-C20/1N	278675	1/60
25	240	15	277	10		FAZ-C25/1N	278676	1/60
32	240	15	277	10		FAZ-C32/1N	278677	1/60
40	240	15	277	5		FAZ-C40/1N	278678	1/60
50	240	15	277	5		FAZ-C50/1N	278679	1/60
63	240	15	277	5		FAZ-C63/1N	278680	1/60

SG55112



Rated current I_n (A)	Rated voltage (V)	Breaking capacity acc. to IEC/EN 60947-2 (kA)	Rated voltage UL1077 (V)	Breaking capacity acc. to UL1077 (kA)	Type Designation	Article No.	Units per package
----------------------------	----------------------	---	--------------------------------	--	---------------------	-------------	-------------------------

2-pole

0.16	415	15	480Y/277	5	FAZ-C0,16/2	278741	1/60
0.25	415	15	480Y/277	5	FAZ-C0,25/2	278742	1/60
0.5	415	15	480Y/277	10	FAZ-C0,5/2	278743	1/60
0.75	415	15	480Y/277	10	FAZ-C0,75/2	278744	1/60
1	415	15	480Y/277	10	FAZ-C1/2	278745	1/60
1.5	415	15	480Y/277	10	FAZ-C1,5/2	278746	1/60
1.6	415	15	480Y/277	10	FAZ-C1,6/2	278747	1/60
2	415	15	480Y/277	10	FAZ-C2/2	278748	1/60
2.5	415	15	480Y/277	10	FAZ-C2,5/2	278749	1/60
3	415	15	480Y/277	10	FAZ-C3/2	278750	1/60
3.5	415	15	480Y/277	10	FAZ-C3,5/2	278751	1/60
4	415	15	480Y/277	10	FAZ-C4/2	278752	1/60
5	415	15	480Y/277	10	FAZ-C5/2	278753	1/60
6	415	15	480Y/277	10	FAZ-C6/2	278754	1/60
8	415	15	480Y/277	10	FAZ-C8/2	278755	1/60
10	415	15	480Y/277	10	FAZ-C10/2	278756	1/60
12	415	15	480Y/277	10	FAZ-C12/2	278757	1/60
13	415	15	480Y/277	10	FAZ-C13/2	278758	1/60
15	415	15	480Y/277	10	FAZ-C15/2	278759	1/60
16	415	15	480Y/277	10	FAZ-C16/2	278760	1/60
20	415	15	480Y/277	10	FAZ-C20/2	278761	1/60
25	415	15	480Y/277	10	FAZ-C25/2	278762	1/60
32	415	15	480Y/277	10	FAZ-C32/2	278763	1/60
40	415	15	480Y/277	5	FAZ-C40/2	278764	1/60
50	415	15	480Y/277	5	FAZ-C50/2	278765	1/60
63	415	15	480Y/277	5	FAZ-C63/2	278766	1/60

SG53412



3-pole

0.16	415	15	480Y/277	5	FAZ-C0,16/3	278854	1/40
0.25	415	15	480Y/277	5	FAZ-C0,25/3	278855	1/40
0.5	415	15	480Y/277	10	FAZ-C0,5/3	278856	1/40
0.75	415	15	480Y/277	10	FAZ-C0,75/3	278857	1/40
1	415	15	480Y/277	10	FAZ-C1/3	278858	1/40
1.5	415	15	480Y/277	10	FAZ-C1,5/3	278859	1/40
1.6	415	15	480Y/277	10	FAZ-C1,6/3	278860	1/40
2	415	15	480Y/277	10	FAZ-C2/3	278861	1/40
2.5	415	15	480Y/277	10	FAZ-C2,5/3	278862	1/40
3	415	15	480Y/277	10	FAZ-C3/3	278863	1/40
3.5	415	15	480Y/277	10	FAZ-C3,5/3	278864	1/40
4	415	15	480Y/277	10	FAZ-C4/3	278865	1/40
5	415	15	480Y/277	10	FAZ-C5/3	278866	1/40
6	415	15	480Y/277	10	FAZ-C6/3	278867	1/40
8	415	15	480Y/277	10	FAZ-C8/3	278868	1/40
10	415	15	480Y/277	10	FAZ-C10/3	278869	1/40
12	415	15	480Y/277	10	FAZ-C12/3	278870	1/40
13	415	15	480Y/277	10	FAZ-C13/3	278871	1/40
15	415	15	480Y/277	10	FAZ-C15/3	278872	1/40
16	415	15	480Y/277	10	FAZ-C16/3	278873	1/40
20	415	15	480Y/277	10	FAZ-C20/3	278874	1/40
25	415	15	480Y/277	10	FAZ-C25/3	278875	1/40
32	415	15	480Y/277	10	FAZ-C32/3	278876	1/40
40	415	15	480Y/277	5	FAZ-C40/3	278877	1/40
50	415	15	480Y/277	5	FAZ-C50/3	278878	1/40
63	415	15	480Y/277	5	FAZ-C63/3	278879	1/40

SG55712



3+N-pole

Rated current I_n (A)	Rated voltage (V)	Breaking capacity acc. to IEC/EN 60947-2 (kA)	Rated voltage UL1077 (V)	Breaking capacity acc. to UL1077 (kA)	Type Designation	Article No.	Units per package
0.16	415	15	480Y/277	5	FAZ-C0,16/3N	278956	1/30
0.25	415	15	480Y/277	5	FAZ-C0,25/3N	278957	1/30
0.5	415	15	480Y/277	10	FAZ-C0,5/3N	278958	1/30
0.75	415	15	480Y/277	10	FAZ-C0,75/3N	278959	1/30
1	415	15	480Y/277	10	FAZ-C1/3N	278960	1/30
1.5	415	15	480Y/277	10	FAZ-C1,5/3N	278961	1/30
1.6	415	15	480Y/277	10	FAZ-C1,6/3N	278962	1/30
2	415	15	480Y/277	10	FAZ-C2/3N	278963	1/30
2.5	415	15	480Y/277	10	FAZ-C2,5/3N	278964	1/30
3	415	15	480Y/277	10	FAZ-C3/3N	278965	1/30
3.5	415	15	480Y/277	10	FAZ-C3,5/3N	278966	1/30
4	415	15	480Y/277	10	FAZ-C4/3N	278967	1/30
5	415	15	480Y/277	10	FAZ-C5/3N	278968	1/30
6	415	15	480Y/277	10	FAZ-C6/3N	278969	1/30
8	415	15	480Y/277	10	FAZ-C8/3N	278970	1/30
10	415	15	480Y/277	10	FAZ-C10/3N	278971	1/30
12	415	15	480Y/277	10	FAZ-C12/3N	278972	1/30
13	415	15	480Y/277	10	FAZ-C13/3N	278973	1/30
15	415	15	480Y/277	10	FAZ-C15/3N	278974	1/30
16	415	15	480Y/277	10	FAZ-C16/3N	278975	1/30
20	415	15	480Y/277	10	FAZ-C20/3N	278976	1/30
25	415	15	480Y/277	10	FAZ-C25/3N	278977	1/30
32	415	15	480Y/277	10	FAZ-C32/3N	278978	1/30
40	415	15	480Y/277	5	FAZ-C40/3N	278979	1/30
50	415	15	480Y/277	5	FAZ-C50/3N	278980	1/30
63	415	15	480Y/277	5	FAZ-C63/3N	278981	1/30

SG55812



4-pole

Rated current I_n (A)	Rated voltage (V)	Breaking capacity acc. to IEC/EN 60947-2 (kA)	Rated voltage UL1077 (V)	Breaking capacity acc. to UL1077 (kA)	Type Designation	Article No.	Units per package
0.16	415	15	480Y/277	5	FAZ-C0,16/4	279042	1/30
0.25	415	15	480Y/277	5	FAZ-C0,25/4	279043	1/30
0.5	415	15	480Y/277	10	FAZ-C0,5/4	279044	1/30
0.75	415	15	480Y/277	10	FAZ-C0,75/4	279045	1/30
1	415	15	480Y/277	10	FAZ-C1/4	279046	1/30
1.5	415	15	480Y/277	10	FAZ-C1,5/4	279047	1/30
1.6	415	15	480Y/277	10	FAZ-C1,6/4	279048	1/30
2	415	15	480Y/277	10	FAZ-C2/4	279049	1/30
2.5	415	15	480Y/277	10	FAZ-C2,5/4	279050	1/30
3	415	15	480Y/277	10	FAZ-C3/4	279051	1/30
3.5	415	15	480Y/277	10	FAZ-C3,5/4	279052	1/30
4	415	15	480Y/277	10	FAZ-C4/4	279053	1/30
5	415	15	480Y/277	10	FAZ-C5/4	279054	1/30
6	415	15	480Y/277	10	FAZ-C6/4	279055	1/30
8	415	15	480Y/277	10	FAZ-C8/4	279056	1/30
10	415	15	480Y/277	10	FAZ-C10/4	279057	1/30
12	415	15	480Y/277	10	FAZ-C12/4	279058	1/30
13	415	15	480Y/277	10	FAZ-C13/4	279059	1/30
15	415	15	480Y/277	10	FAZ-C15/4	279060	1/30
16	415	15	480Y/277	10	FAZ-C16/4	279061	1/30
20	415	15	480Y/277	10	FAZ-C20/4	279062	1/30
25	415	15	480Y/277	10	FAZ-C25/4	279063	1/30
32	415	15	480Y/277	10	FAZ-C32/4	279064	1/30
40	415	15	480Y/277	5	FAZ-C40/4	279065	1/30
50	415	15	480Y/277	5	FAZ-C50/4	279066	1/30
63	415	15	480Y/277	5	FAZ-C63/4	279067	1/30

FAZ Miniature Circuit Breakers (MCBs)

Characteristic D

	Rated current I_n (A)	Rated voltage (V)	Breaking capacity acc. to IEC/EN 60947-2 (kA)	Rated voltage UL1077 (V)	Breaking capacity acc. to UL1077 (kA)	Type Designation	Article No.	Units per package
1-pole								
0.5	240/415	15	277	5		FAZ-D0,5/1	278568	12/120
1	240/415	15	277	5		FAZ-D1/1	278569	12/120
1.5	240/415	15	277	5		FAZ-D1,5/1	278570	12/120
1.6	240/415	15	277	5		FAZ-D1,6/1	278571	12/120
2	240/415	15	277	5		FAZ-D2/1	278572	12/120
2.5	240/415	15	277	5		FAZ-D2,5/1	278573	12/120
3	240/415	15	277	5		FAZ-D3/1	278574	12/120
3.5	240/415	15	277	5		FAZ-D3,5/1	278575	12/120
4	240/415	15	277	5		FAZ-D4/1	278576	12/120
5	240/415	15	277	5		FAZ-D5/1	278577	12/120
6	240/415	15	277	5		FAZ-D6/1	278578	12/120
8	240/415	15	277	5		FAZ-D8/1	278579	12/120
10	240/415	15	277	5		FAZ-D10/1	278580	12/120
12	240/415	15	277	5		FAZ-D12/1	278581	12/120
13	240/415	15	277	5		FAZ-D13/1	278582	12/120
15	240/415	15	277	5		FAZ-D15/1	278583	12/120
16	240/415	15	277	5		FAZ-D16/1	278584	12/120
20	240/415	15	277	5		FAZ-D20/1	278585	12/120
25	240/415	15	277	5		FAZ-D25/1	278586	12/120
32	240/415	15	277	5		FAZ-D32/1	278587	12/120
40	240/415	15	277	5		FAZ-D40/1	278588	12/120
50	240/415	10	-	-		FAZ-D50/1	115370	12/120
63	240/415	10	-	-		FAZ-D63/1	115371	12/120

SG53112



SG55612



1+N-pole								
0.5	240	15	277	5		FAZ-D0,5/1N	278681	1/60
1	240	15	277	5		FAZ-D1/1N	278682	1/60
1.5	240	15	277	5		FAZ-D1,5/1N	278683	1/60
1.6	240	15	277	5		FAZ-D1,6/1N	278684	1/60
2	240	15	277	5		FAZ-D2/1N	278685	1/60
2.5	240	15	277	5		FAZ-D2,5/1N	278686	1/60
3	240	15	277	5		FAZ-D3/1N	278687	1/60
3.5	240	15	277	5		FAZ-D3,5/1N	278688	1/60
4	240	15	277	5		FAZ-D4/1N	278689	1/60
5	240	15	277	5		FAZ-D5/1N	278690	1/60
6	240	15	277	5		FAZ-D6/1N	278691	1/60
8	240	15	277	5		FAZ-D8/1N	278692	1/60
10	240	15	277	5		FAZ-D10/1N	278693	1/60
12	240	15	277	5		FAZ-D12/1N	278694	1/60
13	240	15	277	5		FAZ-D13/1N	278695	1/60
15	240	15	277	5		FAZ-D15/1N	278696	1/60
16	240	15	277	5		FAZ-D16/1N	278697	1/60
20	240	15	277	5		FAZ-D20/1N	278698	1/60
25	240	15	277	5		FAZ-D25/1N	278699	1/60
32	240	15	277	5		FAZ-D32/1N	278700	1/60
40	240	15	277	5		FAZ-D40/1N	278701	1/60
50	240	10	-	-		FAZ-D50/1N	115378	1/60
63	240	10	-	-		FAZ-D63/1N	115379	1/60

SG55112



Rated current I_n (A)	Rated voltage (V)	Breaking capacity acc. to IEC/EN 60947-2 (kA)	Rated voltage UL1077 (V)	Breaking capacity acc. to UL1077 (kA)	Type Designation	Article No.	Units per package
----------------------------	----------------------	---	--------------------------------	--	---------------------	-------------	-------------------------

2-pole

0,5	415	15	480Y/277	5	FAZ-D0,5/2	278767	1/60
1	415	15	480Y/277	5	FAZ-D1/2	278768	1/60
1.5	415	15	480Y/277	5	FAZ-D1,5/2	278769	1/60
1.6	415	15	480Y/277	5	FAZ-D1,6/2	278770	1/60
2	415	15	480Y/277	5	FAZ-D2/2	278771	1/60
2.5	415	15	480Y/277	5	FAZ-D2,5/2	278772	1/60
3	415	15	480Y/277	5	FAZ-D3/2	278773	1/60
3.5	415	15	480Y/277	5	FAZ-D3,5/2	278774	1/60
4	415	15	480Y/277	5	FAZ-D4/2	278775	1/60
5	415	15	480Y/277	5	FAZ-D5/2	278776	1/60
6	415	15	480Y/277	5	FAZ-D6/2	278777	1/60
8	415	15	480Y/277	5	FAZ-D8/2	278778	1/60
10	415	15	480Y/277	5	FAZ-D10/2	278779	1/60
12	415	15	480Y/277	5	FAZ-D12/2	278780	1/60
13	415	15	480Y/277	5	FAZ-D13/2	278781	1/60
15	415	15	480Y/277	5	FAZ-D15/2	278782	1/60
16	415	15	480Y/277	5	FAZ-D16/2	278783	1/60
20	415	15	480Y/277	5	FAZ-D20/2	278784	1/60
25	415	15	480Y/277	5	FAZ-D25/2	278785	1/60
32	415	15	480Y/277	5	FAZ-D32/2	278786	1/60
40	415	15	480Y/277	5	FAZ-D40/2	278787	1/60
50	415	10	-	-	FAZ-D50/2	115372	1/60
63	415	10	-	-	FAZ-D63/2	115373	1/60

SG53412



3-pole

0.5	415	15	480Y/277	5	FAZ-D0,5/3	278880	1/40
1	415	15	480Y/277	5	FAZ-D1/3	278881	1/40
1.5	415	15	480Y/277	5	FAZ-D1,5/3	278882	1/40
1.6	415	15	480Y/277	5	FAZ-D1,6/3	278883	1/40
2	415	15	480Y/277	5	FAZ-D2/3	278884	1/40
2.5	415	15	480Y/277	5	FAZ-D2,5/3	278885	1/40
3	415	15	480Y/277	5	FAZ-D3/3	278886	1/40
3.5	415	15	480Y/277	5	FAZ-D3,5/3	278887	1/40
4	415	15	480Y/277	5	FAZ-D4/3	278888	1/40
5	415	15	480Y/277	5	FAZ-D5/3	278889	1/40
6	415	15	480Y/277	5	FAZ-D6/3	278890	1/40
8	415	15	480Y/277	5	FAZ-D8/3	278891	1/40
10	415	15	480Y/277	5	FAZ-D10/3	278892	1/40
12	415	15	480Y/277	5	FAZ-D12/3	278893	1/40
13	415	15	480Y/277	5	FAZ-D13/3	278894	1/40
15	415	15	480Y/277	5	FAZ-D15/3	278895	1/40
16	415	15	480Y/277	5	FAZ-D16/3	278896	1/40
20	415	15	480Y/277	5	FAZ-D20/3	278897	1/40
25	415	15	480Y/277	5	FAZ-D25/3	278898	1/40
32	415	15	480Y/277	5	FAZ-D32/3	278899	1/40
40	415	15	480Y/277	5	FAZ-D40/3	278900	1/40
50	415	10	-	-	FAZ-D50/3	115374	1/40
63	415	10	-	-	FAZ-D63/3	115375	1/40

SG55712



Rated current I_n (A)	Rated voltage (V)	Breaking capacity acc. to IEC/EN 60947-2 (kA)	Rated voltage UL1077 (V)	Breaking capacity acc. to UL1077 (kA)	Type Designation	Article No.	Units per package
----------------------------	----------------------	---	--------------------------------	--	---------------------	-------------	-------------------------

3+N-pole

0.5	415	15	480Y/277	5	FAZ-D0,5/3N	278982	1/30
1	415	15	480Y/277	5	FAZ-D1/3N	278983	1/30
1.5	415	15	480Y/277	5	FAZ-D1,5/3N	278984	1/30
1.6	415	15	480Y/277	5	FAZ-D1,6/3N	278985	1/30
2	415	15	480Y/277	5	FAZ-D2/3N	278986	1/30
2.5	415	15	480Y/277	5	FAZ-D2,5/3N	278987	1/30
3	415	15	480Y/277	5	FAZ-D3/3N	278988	1/30
3.5	415	15	480Y/277	5	FAZ-D3,5/3N	278989	1/30
4	415	15	480Y/277	5	FAZ-D4/3N	278990	1/30
5	415	15	480Y/277	5	FAZ-D5/3N	278991	1/30
6	415	15	480Y/277	5	FAZ-D6/3N	278992	1/30
8	415	15	480Y/277	5	FAZ-D8/3N	278993	1/30
10	415	15	480Y/277	5	FAZ-D10/3N	278994	1/30
12	415	15	480Y/277	5	FAZ-D12/3N	278995	1/30
13	415	15	480Y/277	5	FAZ-D13/3N	278996	1/30
15	415	15	480Y/277	5	FAZ-D15/3N	278997	1/30
16	415	15	480Y/277	5	FAZ-D16/3N	278998	1/30
20	415	15	480Y/277	5	FAZ-D20/3N	278999	1/30
25	415	15	480Y/277	5	FAZ-D25/3N	279000	1/30
32	415	15	480Y/277	5	FAZ-D32/3N	279001	1/30
40	415	15	480Y/277	5	FAZ-D40/3N	279002	1/30
50	415	10	-	-	FAZ-D50/3N	115380	1/30
63	415	10	-	-	FAZ-D63/3N	115381	1/30

SG55812



4-pole

0.5	415	15	480Y/277	5	FAZ-D0,5/4	279068	1/30
1	415	15	480Y/277	5	FAZ-D1/4	279069	1/30
1.5	415	15	480Y/277	5	FAZ-D1,5/4	279070	1/30
1.6	415	15	480Y/277	5	FAZ-D1,6/4	279071	1/30
2	415	15	480Y/277	5	FAZ-D2/4	279072	1/30
2.5	415	15	480Y/277	5	FAZ-D2,5/4	279073	1/30
3	415	15	480Y/277	5	FAZ-D3/4	279074	1/30
3.5	415	15	480Y/277	5	FAZ-D3,5/4	279075	1/30
4	415	15	480Y/277	5	FAZ-D4/4	279076	1/30
5	415	15	480Y/277	5	FAZ-D5/4	279077	1/30
6	415	15	480Y/277	5	FAZ-D6/4	279078	1/30
8	415	15	480Y/277	5	FAZ-D8/4	279079	1/30
10	415	15	480Y/277	5	FAZ-D10/4	279080	1/30
12	415	15	480Y/277	5	FAZ-D12/4	279081	1/30
13	415	15	480Y/277	5	FAZ-D13/4	279082	1/30
15	415	15	480Y/277	5	FAZ-D15/4	279083	1/30
16	415	15	480Y/277	5	FAZ-D16/4	279084	1/30
20	415	15	480Y/277	5	FAZ-D20/4	279085	1/30
25	415	15	480Y/277	5	FAZ-D25/4	279086	1/30
32	415	15	480Y/277	5	FAZ-D32/4	279087	1/30
40	415	15	480Y/277	5	FAZ-D40/4	279088	1/30
50	415	10	-	-	FAZ-D50/4	115376	1/30
63	415	10	-	-	FAZ-D63/4	115377	1/30

FAZ Miniature Circuit Breakers (MCBs)

Characteristic K

	Rated current I_n (A)	Rated voltage (V)	Breaking capacity acc. to IEC/EN 60947-2 (kA)	Rated voltage UL1077 (V)	Breaking capacity acc. to UL1077 (kA)	Type Designation	Article No.	Units per package
1-pole								
	0.5	240/415	15	277	5	FAZ-K0,5/1	278589	12/120
	1	240/415	15	277	5	FAZ-K1/1	278590	12/120
	1.6	240/415	15	277	5	FAZ-K1,6/1	278591	12/120
	2	240/415	15	277	5	FAZ-K2/1	278592	12/120
	3	240/415	15	277	5	FAZ-K3/1	278593	12/120
	4	240/415	15	277	5	FAZ-K4/1	278594	12/120
	6	240/415	15	277	5	FAZ-K6/1	278595	12/120
	8	240/415	15	277	5	FAZ-K8/1	278596	12/120
	10	240/415	15	277	5	FAZ-K10/1	278597	12/120
	13	240/415	15	277	5	FAZ-K13/1	278598	12/120
	16	240/415	15	277	5	FAZ-K16/1	278599	12/120
	20	240/415	15	277	5	FAZ-K20/1	278600	12/120
	25	240/415	15	277	5	FAZ-K25/1	278601	12/120
	32	240/415	15	277	5	FAZ-K32/1	278602	12/120
	40	240/415	15	277	5	FAZ-K40/1	278603	12/120
	50	240/415	15	277	5	FAZ-K50/1	278604	12/120
	63	240/415	15	277	5	FAZ-K63/1	278605	12/120

SG53112



SG55612



1+N-pole								
	0.5	240	15	277	5	FAZ-K0,5/1N	278702	1/60
	1	240	15	277	5	FAZ-K1/1N	278703	1/60
	1.6	240	15	277	5	FAZ-K1,6/1N	278704	1/60
	2	240	15	277	5	FAZ-K2/1N	278705	1/60
	3	240	15	277	5	FAZ-K3/1N	278706	1/60
	4	240	15	277	5	FAZ-K4/1N	278707	1/60
	6	240	15	277	5	FAZ-K6/1N	278708	1/60
	8	240	15	277	5	FAZ-K8/1N	278709	1/60
	10	240	15	277	5	FAZ-K10/1N	278710	1/60
	13	240	15	277	5	FAZ-K13/1N	278711	1/60
	16	240	15	277	5	FAZ-K16/1N	278712	1/60
	20	240	15	277	5	FAZ-K20/1N	278713	1/60
	25	240	15	277	5	FAZ-K25/1N	278714	1/60
	32	240	15	277	5	FAZ-K32/1N	278715	1/60
	40	240	15	277	5	FAZ-K40/1N	278716	1/60
	50	240	15	277	5	FAZ-K50/1N	278717	1/60
	63	240	15	277	5	FAZ-K63/1N	278718	1/60

SG55112



Rated current I_n (A)	Rated voltage (V)	Breaking capacity acc. to IEC/EN 60947-2 (kA)	Rated voltage UL1077 (V)	Breaking capacity acc. to UL1077 (kA)	Type Designation	Article No.	Units per package
----------------------------	----------------------	---	--------------------------------	--	---------------------	-------------	-------------------------

2-pole

0.5	415	15	480Y/277	5	FAZ-K0,5/2	278788	1/60
1	415	15	480Y/277	5	FAZ-K1/2	278789	1/60
1.6	415	15	480Y/277	5	FAZ-K1,6/2	278790	1/60
2	415	15	480Y/277	5	FAZ-K2/2	278791	1/60
3	415	15	480Y/277	5	FAZ-K3/2	278792	1/60
4	415	15	480Y/277	5	FAZ-K4/2	278793	1/60
6	415	15	480Y/277	5	FAZ-K6/2	278794	1/60
8	415	15	480Y/277	5	FAZ-K8/2	278795	1/60
10	415	15	480Y/277	5	FAZ-K10/2	278796	1/60
13	415	15	480Y/277	5	FAZ-K13/2	278797	1/60
16	415	15	480Y/277	5	FAZ-K16/2	278798	1/60
20	415	15	480Y/277	5	FAZ-K20/2	278799	1/60
25	415	15	480Y/277	5	FAZ-K25/2	278800	1/60
32	415	15	480Y/277	5	FAZ-K32/2	278801	1/60
40	415	15	480Y/277	5	FAZ-K40/2	278802	1/60
50	415	15	480Y/277	5	FAZ-K50/2	278803	1/60
63	415	15	480Y/277	5	FAZ-K63/2	278804	1/60

SG53412



3-pole

0.5	415	15	480Y/277	5	FAZ-K0,5/3	278901	1/40
1	415	15	480Y/277	5	FAZ-K1/3	278902	1/40
1.6	415	15	480Y/277	5	FAZ-K1,6/3	278903	1/40
2	415	15	480Y/277	5	FAZ-K2/3	278904	1/40
3	415	15	480Y/277	5	FAZ-K3/3	278905	1/40
4	415	15	480Y/277	5	FAZ-K4/3	278906	1/40
6	415	15	480Y/277	5	FAZ-K6/3	278907	1/40
8	415	15	480Y/277	5	FAZ-K8/3	278908	1/40
10	415	15	480Y/277	5	FAZ-K10/3	278909	1/40
13	415	15	480Y/277	5	FAZ-K13/3	278910	1/40
16	415	15	480Y/277	5	FAZ-K16/3	278911	1/40
20	415	15	480Y/277	5	FAZ-K20/3	278912	1/40
25	415	15	480Y/277	5	FAZ-K25/3	278913	1/40
32	415	15	480Y/277	5	FAZ-K32/3	278914	1/40
40	415	15	480Y/277	5	FAZ-K40/3	278915	1/40
50	415	15	480Y/277	5	FAZ-K50/3	278916	1/40
63	415	15	480Y/277	5	FAZ-K63/3	278917	1/40

SG55712



3+N-pole

Rated current I_n (A)	Rated voltage (V)	Breaking capacity acc. to IEC/EN 60947-2 (kA)	Rated voltage UL1077 (V)	Breaking capacity acc. to UL1077 (kA)	Type Designation	Article No.	Units per package
0.5	415	15	480Y/277	5	FAZ-K0,5/3N	279003	1/30
1	415	15	480Y/277	5	FAZ-K1/3N	279004	1/30
1.6	415	15	480Y/277	5	FAZ-K1,6/3N	279005	1/30
2	415	15	480Y/277	5	FAZ-K2/3N	279006	1/30
3	415	15	480Y/277	5	FAZ-K3/3N	279007	1/30
4	415	15	480Y/277	5	FAZ-K4/3N	279008	1/30
6	415	15	480Y/277	5	FAZ-K6/3N	279009	1/30
8	415	15	480Y/277	5	FAZ-K8/3N	279010	1/30
10	415	15	480Y/277	5	FAZ-K10/3N	279011	1/30
13	415	15	480Y/277	5	FAZ-K13/3N	279012	1/30
16	415	15	480Y/277	5	FAZ-K16/3N	279013	1/30
20	415	15	480Y/277	5	FAZ-K20/3N	279014	1/30
25	415	15	480Y/277	5	FAZ-K25/3N	279015	1/30
32	415	15	480Y/277	5	FAZ-K32/3N	279016	1/30
40	415	15	480Y/277	5	FAZ-K40/3N	279017	1/30
50	415	15	480Y/277	5	FAZ-K50/3N	279018	1/30
63	415	15	480Y/277	5	FAZ-K63/3N	279019	1/30

SG55812



4-pole

Rated current I_n (A)	Rated voltage (V)	Breaking capacity acc. to IEC/EN 60947-2 (kA)	Rated voltage UL1077 (V)	Breaking capacity acc. to UL1077 (kA)	Type Designation	Article No.	Units per package
0.5	415	15	480Y/277	5	FAZ-K0,5/4	279089	1/30
1	415	15	480Y/277	5	FAZ-K1/4	279090	1/30
1.6	415	15	480Y/277	5	FAZ-K1,6/4	279091	1/30
2	415	15	480Y/277	5	FAZ-K2/4	279092	1/30
3	415	15	480Y/277	5	FAZ-K3/4	279093	1/30
4	415	15	480Y/277	5	FAZ-K4/4	279094	1/30
6	415	15	480Y/277	5	FAZ-K6/4	279095	1/30
8	415	15	480Y/277	5	FAZ-K8/4	279096	1/30
10	415	15	480Y/277	5	FAZ-K10/4	279097	1/30
13	415	15	480Y/277	5	FAZ-K13/4	279098	1/30
16	415	15	480Y/277	5	FAZ-K16/4	279099	1/30
20	415	15	480Y/277	5	FAZ-K20/4	279100	1/30
25	415	15	480Y/277	5	FAZ-K25/4	279101	1/30
32	415	15	480Y/277	5	FAZ-K32/4	279102	1/30
40	415	15	480Y/277	5	FAZ-K40/4	279103	1/30
50	415	15	480Y/277	5	FAZ-K50/4	279104	1/30
63	415	15	480Y/277	5	FAZ-K63/4	279105	1/30

FAZ Miniature Circuit Breakers (MCBs)

Characteristic S

	Rated current I_n (A)	Rated voltage (V)	Breaking capacity acc. to IEC/EN 60947-2 (kA)	Rated voltage UL1077 (V)	Breaking capacity acc. to UL1077 (kA)	Type Designation	Article No.	Units per package
1-pole								
	1	240/415	10	277	5	FAZ-S1/1	278606	12/120
	2	240/415	10	277	5	FAZ-S2/1	278607	12/120
	3	240/415	10	277	5	FAZ-S3/1	278608	12/120
	4	240/415	10	277	5	FAZ-S4/1	278609	12/120
	6	240/415	10	277	5	FAZ-S6/1	278610	12/120
	10	240/415	10	277	5	FAZ-S10/1	278611	12/120
	16	240/415	10	277	5	FAZ-S16/1	278612	12/120
	20	240/415	10	277	5	FAZ-S20/1	278613	12/120
	25	240/415	10	277	5	FAZ-S25/1	278614	12/120
	32	240/415	10	277	5	FAZ-S32/1	278615	12/120
	40	240/415	10	277	5	FAZ-S40/1	278616	12/120

SG53112



SG55112



2-pole								
	1	415	10	480Y/277	5	FAZ-S1/2	278805	1/60
	2	415	10	480Y/277	5	FAZ-S2/2	278806	1/60
	3	415	10	480Y/277	5	FAZ-S3/2	278807	1/60
	4	415	10	480Y/277	5	FAZ-S4/2	278808	1/60
	6	415	10	480Y/277	5	FAZ-S6/2	278809	1/60
	10	415	10	480Y/277	5	FAZ-S10/2	278810	1/60
	16	415	10	480Y/277	5	FAZ-S16/2	278811	1/60
	20	415	10	480Y/277	5	FAZ-S20/2	278812	1/60
	25	415	10	480Y/277	5	FAZ-S25/2	278813	1/60
	32	415	10	480Y/277	5	FAZ-S32/2	278814	1/60
	40	415	10	480Y/277	5	FAZ-S40/2	278815	1/60

FAZ Miniature Circuit Breakers (MCBs)

Characteristic Z

Rated current I_n (A)	Rated voltage (V)	Breaking capacity acc. to IEC/EN 60947-2 (kA)	Rated voltage UL1077 (V)	Breaking capacity acc. to UL1077 (kA)	Type Designation	Article No.	Units per package
1-pole							
0,5	240/415	15	277	5	FAZ-Z0,5/1	278617	12/120
1	240/415	15	277	5	FAZ-Z1/1	278618	12/120
1.6	240/415	15	277	5	FAZ-Z1,6/1	278619	12/120
2	240/415	15	277	5	FAZ-Z2/1	278620	12/120
3	240/415	15	277	5	FAZ-Z3/1	278621	12/120
4	240/415	15	277	5	FAZ-Z4/1	278622	12/120
6	240/415	15	277	5	FAZ-Z6/1	278623	12/120
8	240/415	15	277	5	FAZ-Z8/1	278624	12/120
10	240/415	15	277	5	FAZ-Z10/1	278625	12/120
13	240/415	15	277	5	FAZ-Z13/1	106020	12/120
16	240/415	15	277	5	FAZ-Z16/1	278626	12/120
20	240/415	15	277	5	FAZ-Z20/1	278627	12/120
25	240/415	15	277	5	FAZ-Z25/1	278628	12/120
32	240/415	15	277	5	FAZ-Z32/1	278629	12/120
40	240/415	15	277	5	FAZ-Z40/1	278630	12/120
50	240/415	15	277	5	FAZ-Z50/1	278631	12/120
63	240/415	15	277	5	FAZ-Z63/1	278632	12/120

SG53112



SG55112



2-pole							
0,5	415	15	480Y/277	5	FAZ-Z0,5/2	278816	1/60
1	415	15	480Y/277	5	FAZ-Z1/2	278817	1/60
1.6	415	15	480Y/277	5	FAZ-Z1,6/2	278818	1/60
2	415	15	480Y/277	5	FAZ-Z2/2	278819	1/60
3	415	15	480Y/277	5	FAZ-Z3/2	278820	1/60
4	415	15	480Y/277	5	FAZ-Z4/2	278821	1/60
6	415	15	480Y/277	5	FAZ-Z6/2	278822	1/60
8	415	15	480Y/277	5	FAZ-Z8/2	278823	1/60
10	415	15	480Y/277	5	FAZ-Z10/2	278824	1/60
13	415	15	480Y/277	5	FAZ-Z13/2	106021	1/60
16	415	15	480Y/277	5	FAZ-Z16/2	278825	1/60
20	415	15	480Y/277	5	FAZ-Z20/2	278826	1/60
25	415	15	480Y/277	5	FAZ-Z25/2	278827	1/60
32	415	15	480Y/277	5	FAZ-Z32/2	278828	1/60
40	415	15	480Y/277	5	FAZ-Z40/2	278829	1/60
50	415	15	480Y/277	5	FAZ-Z50/2	278830	1/60
63	415	15	480Y/277	5	FAZ-Z63/2	278831	1/60

SG53412



3-pole

Rated current I_n (A)	Rated voltage (V)	Breaking capacity acc. to IEC/EN 60947-2 (kA)	Rated voltage UL1077 (V)	Breaking capacity acc. to UL1077 (kA)	Type Designation	Article No.	Units per package
0.5	415	15	480Y/277	5	FAZ-Z0,5/3	278918	1/40
1	415	15	480Y/277	5	FAZ-Z1/3	278919	1/40
1.6	415	15	480Y/277	5	FAZ-Z1,6/3	278920	1/40
2	415	15	480Y/277	5	FAZ-Z2/3	278921	1/40
3	415	15	480Y/277	5	FAZ-Z3/3	278922	1/40
4	415	15	480Y/277	5	FAZ-Z4/3	278923	1/40
6	415	15	480Y/277	5	FAZ-Z6/3	278924	1/40
8	415	15	480Y/277	5	FAZ-Z8/3	278925	1/40
10	415	15	480Y/277	5	FAZ-Z10/3	278926	1/40
13	415	15	480Y/277	5	FAZ-Z13/3	106022	1/40
16	415	15	480Y/277	5	FAZ-Z16/3	278927	1/40
20	415	15	480Y/277	5	FAZ-Z20/3	278928	1/40
25	415	15	480Y/277	5	FAZ-Z25/3	278929	1/40
32	415	15	480Y/277	5	FAZ-Z32/3	278930	1/40
40	415	15	480Y/277	5	FAZ-Z40/3	278931	1/40
50	415	15	480Y/277	5	FAZ-Z50/3	278932	1/40
63	415	15	480Y/277	5	FAZ-Z63/3	278933	1/40

SG55812



4-pole

Rated current I_n (A)	Rated voltage (V)	Breaking capacity acc. to IEC/EN 60947-2 (kA)	Rated voltage UL1077 (V)	Breaking capacity acc. to UL1077 (kA)	Type Designation	Article No.	Units per package
0.5	415	15	480Y/277	5	FAZ-Z0,5/4	279106	1/60
1	415	15	480Y/277	5	FAZ-Z1/4	279107	1/60
1.6	415	15	480Y/277	5	FAZ-Z1,6/4	279108	1/60
2	415	15	480Y/277	5	FAZ-Z2/4	279109	1/60
3	415	15	480Y/277	5	FAZ-Z3/4	279110	1/60
4	415	15	480Y/277	5	FAZ-Z4/4	279111	1/60
6	415	15	480Y/277	5	FAZ-Z6/4	279112	1/60
8	415	15	480Y/277	5	FAZ-Z8/4	279113	1/60
10	415	15	480Y/277	5	FAZ-Z10/4	279114	1/60
13	415	15	480Y/277	5	FAZ-Z13/4	106023	1/60
16	415	15	480Y/277	5	FAZ-Z16/4	279115	1/60
20	415	15	480Y/277	5	FAZ-Z20/4	279116	1/60
25	415	15	480Y/277	5	FAZ-Z25/4	279117	1/60
32	415	15	480Y/277	5	FAZ-Z32/4	279118	1/60
40	415	15	480Y/277	5	FAZ-Z40/4	279119	1/60
50	415	15	480Y/277	5	FAZ-Z50/4	279120	1/60
63	415	15	480Y/277	5	FAZ-Z63/4	279121	1/60

FAZ-PN Miniature Circuit Breakers (MCBs)

Characteristic B

Rated current I_n (A)	Rated voltage (V)	Breaking capacity acc. to IEC/EN 60898-1 (kA)	Breaking capacity acc. to IEC/EN 60947-2 (kA)	Type Designation	Article No.	Units per package
1+N-pole (1MU)						
6	240	6	10	FAZ-PN-B6/1N	279146	12/120
10	240	6	10	FAZ-PN-B10/1N	279147	12/120
13	240	6	10	FAZ-PN-B13/1N	279148	12/120
16	240	6	10	FAZ-PN-B16/1N	279149	12/120
20	240	6	10	FAZ-PN-B20/1N	279150	12/120
25	240	6	10	FAZ-PN-B25/1N	279151	12/120
32	240	6	10	FAZ-PN-B32/1N	279152	12/120
40	240	6	10	FAZ-PN-B40/1N	279153	12/120

SG54212



FAZ-PN Miniature Circuit Breakers (MCBs)

Characteristic C



Rated current I_n (A)	Rated voltage (V)	Breaking capacity acc. to IEC/EN 60898-1 (kA)	Breaking capacity acc. to IEC/EN 60947-2 (kA)	Type Designation	Article No.	Units per package
1+N-pole (1MU)						
2	240	6	10	FAZ-PN-C2/1N	279154	12/120
4	240	6	10	FAZ-PN-C4/1N	279155	12/120
6	240	6	10	FAZ-PN-C6/1N	279156	12/120
10	240	6	10	FAZ-PN-C10/1N	279157	12/120
13	240	6	10	FAZ-PN-C13/1N	279158	12/120
16	240	6	10	FAZ-PN-C16/1N	279159	12/120
20	240	6	10	FAZ-PN-C20/1N	279160	12/120
25	240	6	10	FAZ-PN-C25/1N	279161	12/120
32	240	6	10	FAZ-PN-C32/1N	279162	12/120
40	240	6	10	FAZ-PN-C40/1N	279163	12/120

SG54212



FAZ-...-HS Miniature Circuit Breakers (MCBs)

Characteristic B

	Rated current I_n (A)	Rated voltage (V)	Breaking capacity acc. to IEC/EN 60898-1 (kA)	Type Designation	Article No.	Units per package
1-pole						
 wa_sg00114	4	240	10	FAZ-B4/1-HS	279274	12/120
2-pole						
 SG55512	4	240	10	FAZ-B4/2-HS	279275	1/60

FAZ Miniature Circuit Breakers

Accessories:

Auxiliary switch for subsequent installation	ZP-IHK	286052
Auxiliary switch for subsequent installation	ZP-WHK	286053
Tripping signal contact for subsequent installation	ZP-NHK	248437
Shunt trip release	ZP-ASA	248438, 248439
Undervoltage release	Z-USA	258288, 248289, 248290
	Z-USD	248292, 248291
Switching interlock	Z-IS/SPE-1TE	274418
Terminal cover		
1-pole	Z-TC/MCB-1P	178102
2-pole	Z-TC/SD-2P	178099
3-pole	Z-TC/SD-3P	178100
4-pole	Z-TC/SD-4P	178101

Specifications FAZ

Technical data

	B Curve	C Curve	D Curve
Electrical			
Approvals	UR (UL 1077), CSA (CSA 22.2 No. 235), CE, VDE		
Standards	IEC/EN 60947-2		
Short-circuit trip response	3–5 I_n	5–10 I_n	10–20 I_n
Supplementary Protectors – UL/CSA			
Current range	1–63A	0.5–63A	0.5–40A
Maximum voltage ratings – UL/CSA			
Single-pole	277 Vac 48 Vdc	277 Vac 48 Vdc	277 Vac 48 Vdc
Two-, three-pole	480Y/277 Vac	480Y/277 Vac	480Y/277 Vac
Two poles in series	96 Vdc	96 Vdc	96 Vdc
Thermal tripping characteristics			
Single-pole	< 1 hour @ 1.35 x I_n @ 40°C	< 1 hour @ 1.35 x I_n @ 40°C	< 1 hour @ 1.35 x I_n @ 40°C
Multi-pole	< 1 hour @ 1.45 x I_n @ 40°C	< 1 hour @ 1.45 x I_n @ 40°C	< 1 hour @ 1.45 x I_n @ 40°C
Short-circuit ratings (at max. voltage)			
Single-pole	10 kA (5 kA for 40–63A device)	10 kA (5 kA for 40–63A device)	5 kA
Two-, three-pole	10 kA (5 kA for 40–63A device)	10 kA (5 kA for 40–63A device)	5 kA
Single-pole	10 kA @ 48 Vdc	10 kA @ 48 Vdc	10 kA @ 48 Vdc
Two poles in series	10 kA @ 96 Vdc	10 kA @ 96 Vdc	10 kA @ 96 Vdc
Miniature Circuit Breaker – IEC			
Current range	1–63A	0.5–63A	0.5–63A
Maximum voltage ratings – IEC 60947-2			
Single-pole	230 Vac 60 Vdc	230 Vac 60 Vdc	230 Vac 60 Vdc
Two-, three-pole	230/400 Vac	230/400 Vac	230/400 Vac
Maximum Voltage Ratings – IEC 60898			
Single-pole	240 Vac	240 Vac	240 Vac
Two-, three-pole	240/415 Vac	240/415 Vac	240/415 Vac
Thermal tripping characteristics			
	> 1 hour @ 1.05 x I_n @ 40°C < 1 hour @ 1.3 x I_n @ 40°C	> 1 hour @ 1.05 x I_n @ 40°C < 1 hour @ 1.3 x I_n @ 40°C	> 1 hour @ 1.05 x I_n @ 40°C < 1 hour @ 1.3 x I_n @ 40°C
Interrupt ratings (at max. voltage)			
IEC 60947-2	15 kA	15 kA	15 kA (type D50 and D63: 10kA)
IEC 60898	10 kA	10 kA	10 kA (type D50 and D63: 6kA)
Operational switching capacity	7.5 kA	7.5 kA	7.5 kA (type D50 and D63: 6kA)
Max. back-up fuse [gL/gG]	125A	125A	125A
Rated impulse withstand – U_{imp}	4000 Vac	4000 Vac	4000 Vac
Rated insulation voltage – U_i	440 Vac	440 Vac	440 Vac
Environmental/General			
Selectivity class	3	3	3
Lifespan (operations)	> 10000 (1 operation = ON/OFF)	> 10000 (1 operation = ON/OFF)	> 10000 (1 operation = ON/OFF)
Shock (IEC 68-2-22)	10g–120 ms	10g–120 ms	10g–120 ms
Operating temperature range	-40 to +75°C	-40 to +75°C	-40 to +75°C
Mechanical			
Standard front dimension			
Device height	80 mm	80 mm	80 mm
Terminal protection	Finger and back-of-hand proof	Finger and back-of-hand proof	Finger and back-of-hand proof
Mounting width per pole	17.5 mm	17.5 mm	17.5 mm
Mounting	IEC/EN 60715 top-hat rail	IEC/EN 60715 top-hat rail	IEC/EN 60715 top-hat rail
Degree of protection	IP20	IP20	IP20
Terminals top and bottom	Twin-purpose terminals	Twin-purpose terminals	Twin-purpose terminals
Supply connection	Line or load side	Line or load side	Line or load side
Terminal capacity [mm ²]	1 x 25 / 2 x 10	1 x 25 / 2 x 10	1 x 25 / 2 x 10
Torque	2.4 Nm	2.4 Nm	2.4 Nm
Thickness of busbar material	0.8–2 mm	0.8–2 mm	0.8–2 mm
Mounting position	As required	As required	As required

Specifications FAZ

Technical Data (continued)

	K Curve	S Curve	Z Curve
Electrical			
Approvals	UR (UL 1077), CE	UR (UL 1077), CSA (CSA 22.2 No. 235) for 1-16 A, CE	UR (UL 1077), CE
Standards	IEC/EN 60947-2		
Short-circuit trip response	8–12 I_n	13–17 I_n	2–3 I_n
Supplementary Protectors—UL/CSA			
Current range	0.5–63A	0.5–40A	1–63A
Maximum voltage ratings—UL/CSA			
Single-pole, single-pole + neutral	277 Vac 48 Vdc	277 Vac 48 Vdc	277 Vac 48 Vdc
Two-, three-, four-pole and three-pole + neutral	480Y/277 Vac	480Y/277 Vac	480Y/277 Vac
Two poles in series	96 Vdc	96 Vdc	96 Vdc
Thermal tripping characteristics			
Single-pole	< 1 hour @ 1.35 x I_n @ 40°C	< 1 hour @ 1.35 x I_n @ 40°C	< 1 hour @ 1.35 x I_n @ 40°C
Multi-pole	< 1 hour @ 1.45 x I_n @ 40°C	< 1 hour @ 1.45 x I_n @ 40°C	< 1 hour @ 1.45 x I_n @ 40°C
Short-circuit ratings (at max. voltage)			
Single-pole	5 kA @ 277 Vac	5 kA @ 277 Vac	5 kA @ 277 Vac
Single-pole + neutral	5 kA @ 277 Vac	5 kA @ 277 Vac	5 kA @ 277 Vac
Two-, three-, four-pole	5 kA @ 480Y/277 Vac	5 kA @ 480Y/277 Vac	5 kA @ 480Y/277 Vac
Miniature Circuit Breaker—IEC			
Current range	0.5–63A	0.5–40A	1–63A
Maximum voltage ratings—IEC 60947-2			
Single-pole, single-pole + neutral	240 Vac	240 Vac	240 Vac
Single-pole	60 Vdc	60 Vdc	60 Vdc
Two-, three-, four-pole, three-pole + neutral	240/415 Vac	240/415 Vac	240/415 Vac
Thermal tripping characteristics			
	> 1 hour @ 1.05 x I_n @ 30°C < 1 hour @ 1.3 x I_n @ 30°C	> 1 hour @ 1.05 x I_n @ 30°C < 1 hour @ 1.3 x I_n @ 30°C	> 1 hour @ 1.05 x I_n @ 30°C < 1 hour @ 1.3 x I_n @ 30°C
Interrupt ratings (at max. voltage)			
IEC 60947-2	15 kA	10 kA	10 kA
Operational switching capacity	7.5 kA	7.5 kA	7.5 kA
Max. back-up fuse [gL/gG]	125A	125A	125A
Rated impulse withstand— U_{imp}	4000 Vac	4000 Vac	4000 Vac
Rated insulation voltage— U_i	440 Vac	440 Vac	440 Vac
Environmental/General			
Selectivity class	3	3	3
Lifespan (operations)	> 10000 (1 operation = ON/OFF)	> 10000 (1 operation = ON/OFF)	> 10000 (1 operation = ON/OFF)
Shock (IEC 68-2-22)	10g–120 ms	10g–120 ms	10g–120 ms
Operating temperature range	-40°C to +75°C	-40°C to +75°C	-40°C to +75°C
Mechanical			
Standard front dimension			
Device height	80 mm	80 mm	80 mm
Terminal protection	Finger and back-of-hand proof	Finger and back-of-hand proof	Finger and back-of-hand proof
Mounting width per pole	17.5 mm	17.5 mm	17.5 mm
Mounting	IEC/EN 60715 top-hat rail	IEC/EN 60715 top-hat rail	IEC/EN 60715 top-hat rail
Degree of protection	IP20	IP20	IP20
Terminals top and bottom	Twin-purpose terminals	Twin-purpose terminals	Twin-purpose terminals
Supply connection	Line or load side	Line or load side	Line or load side
Terminal capacity [mm ²]	1 x 25 / 2 x 10	1 x 25 / 2 x 10	1 x 25 / 2 x 10
Torque	2.4 Nm	2.4 Nm	2.4 Nm
Thickness of busbar material	0.8–2 mm	0.8–2 mm	0.8–2 mm
Mounting position	As required	As required	As required

Connection diagram

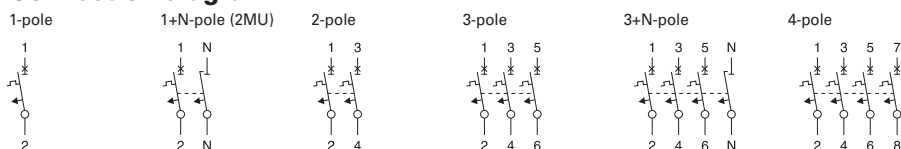

Tripping Characteristic FAZ

Characteristic Z - IEC/EN 60947-2

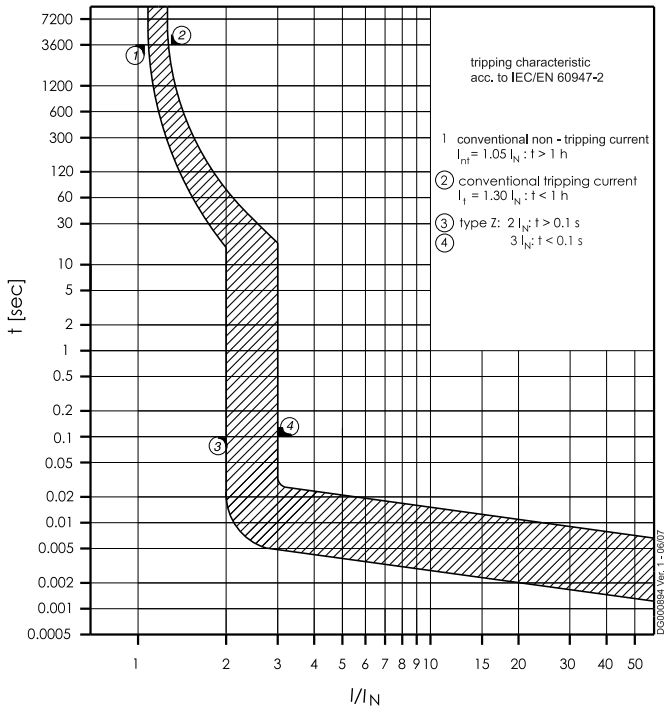

Characteristic Z - UL1077

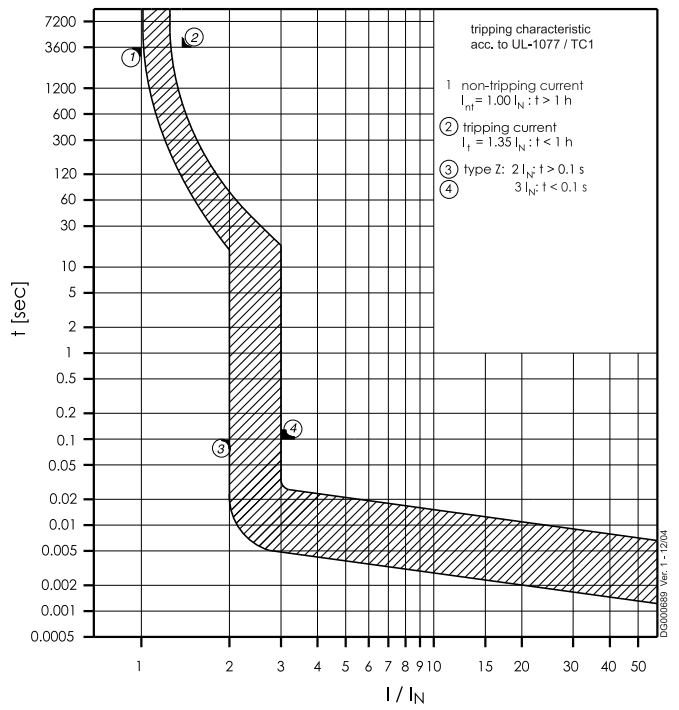

Internal Resistance FAZ

Type B

At room temperature (single pole)

In [A]	Z* [mΩ]	R [mΩ]
1	1120	1102
1.5	922	912
1.6	922	912
2	335	333
2.5	234	230
3	211	208
3.5	184	180
4	87.7	87.2
5	73.5	72.8
6	46.8	46.3
8	30.5	30.4
10	17.5	17.4
12	16.9	16.8
13	13.4	13.3
15	8.0	7.9
16	8.0	7.9
20	7.2	7.1
25	5.0	4.9
32	3.7	3.7
40	2.6	2.5
50	2.1	2.1
63	2.0	2.0

* 50Hz

Type C

At room temperature (single pole)

In [A]	Z* [mΩ]	R [mΩ]
0.16	68500	68300
0.25	27500	27400
0.5	4680	4670
0.75	2280	2250
1	1120	1100
1.5	589	587
1.6	589	587
2	335	333
2.5	234	230
3	131	130
3.5	143	141
4	87.7	87.2
5	73.5	72.8
6	39.3	39.1
8	30.5	30.4
10	14.1	14.0
12	13.5	13.4
13	13.4	13.3
15	8.0	7.9
16	8.0	7.9
20	7.2	7.1
25	5.0	4.9
32	3.7	3.7
40	2.6	2.5
50	2.1	2.1
63	2.0	2.0

* 50Hz

Type D

At room temperature (single pole)

In [A]	Z* [mΩ]	R [mΩ]
0.5	4680	4670
1	772	770
1.5	512	508
1.6	512	508
2	250	249
2.5	153	153
3	131	130
3.5	143	141
4	87.7	87.2
5	65.4	65.1
6	39.3	39.1
8	19.5	19.5
10	14.1	14.0
12	11.3	11.2
13	10.1	10.1
15	8.0	7.9
16	8.0	7.9
20	4.9	4.9
25	3.9	3.8
32	3.5	3.4
40	2.7	2.6

* 50Hz

Fault Loop Impedance FAZ

Max. allowed value for the Fault Loop Impedance Z_s
(acc. to DIN VDE 0100, part 410)

$$U_0 = 230 \text{ V}$$

Tripping time I_n/A	Type B		Type C		Type D	
	0,4s $Z_s (\Omega)$	5s $Z_s (\Omega)$	0,4s $Z_s (\Omega)$	5s $Z_s (\Omega)$	0,4s $Z_s (\Omega)$	5s $Z_s (\Omega)$
1	40,4	40,4	24,3	40,4	12,4	40,4
1.5	26,9	26,9	16,2	26,9	8,3	26,9
2	20,2	20,2	12,2	20,2	6,2	20,2
2.5	16,1	16,1	9,7	16,1	5,0	16,1
3	13,5	13,5	8,1	13,5	4,1	13,5
3.5	11,5	11,5	7,0	11,5	3,6	11,5
4	10,1	10,1	6,1	10,1	3,1	10,1
5	8,1	8,1	4,9	8,1	2,5	8,1
6	6,7	6,7	4,1	6,7	2,1	6,7
8	5,0	5,0	3,0	5,0	1,6	5,0
10	4,0	4,0	2,4	4,0	1,2	4,0
12	3,4	3,4	2,0	3,4	1,0	3,4
13	3,1	3,1	1,9	3,1	1,0	3,1
15	2,7	2,7	1,6	2,7	0,8	2,7
16	2,5	2,5	1,5	2,5	0,8	2,5
20	2,0	2,0	1,2	2,0	0,6	2,0
25	1,6	1,6	1,0	1,6	0,5	1,6
32	1,3	1,3	0,8	1,3	0,4	1,3
40	1,0	1,0	0,6	1,0	0,3	1,0
50	0,8	0,8	0,5	0,8	0,2	0,8
63	0,6	0,6	0,4	0,6	0,2	0,6

$$Z_s = R_{M.C.B.} + R_{Loop}$$

Data/factors taken from the time-current characteristic FAZ

For other rated voltages U_0 :

$$U_0 = 240 \text{ V: } Z_s * 1,04 \text{ applies}$$

$$U_0 = 127 \text{ V: } Z_s * 0,55 \text{ applies}$$

Power Loss at I_n FAZ

Type B

I_n [A]	1p	1pN	2p	3p	3pN*
	P [W]	P [W]	P [W]	P [W]	P [W]
1	1.6	1.7	3.1	4.7	4.8
1.5	2.3	2.5	4.6	6.9	7.2
1.6	2.5	2.7	4.9	7.4	7.6
2	1.4	1.5	2.8	4.1	4.3
2.5	1.5	1.7	3.1	4.6	4.7
3	2.5	2.7	5.0	7.6	7.8
3.5	2.5	2.8	5.1	7.8	8.0
4	1.4	1.6	2.9	4.4	4.5
5	1.9	2.1	3.8	5.8	6.0
6	1.8	2.0	3.6	5.5	5.6
8	2.1	2.3	4.1	6.3	6.5
10	1.9	2.1	3.9	5.9	6.1
12	2.8	3.2	5.9	8.7	9.0
13	2.5	2.9	5.3	7.8	8.1
15	2.1	2.4	4.4	6.5	6.7
16	2.2	2.6	4.7	6.9	7.2
20	3.2	3.6	6.6	9.8	10.1
25	3.0	3.5	6.4	9.4	9.7
32	3.7	4.4	8.1	12.1	12.5
40	3.4	4.1	7.5	11.2	11.5
50	4.5	5.4	9.9	14.9	15.3
63	5.2	6.3	11.5	17.2	17.7

*symmetrical load

Type C

I_n [A]	1p	1pN	2p	3p	3pN*
	P [W]	P [W]	P [W]	P [W]	P [W]
0.16	2.2	2.4	4.4	6.7	6.9
0.25	2.0	2.2	4.0	6.1	6.3
0.5	1.2	1.3	2.4	3.5	3.7
0.75	1.3	1.4	2.6	3.9	4.1
1	1.6	1.7	3.1	4.7	4.8
1.5	1.5	1.6	2.9	4.4	4.6
1.6	1.6	1.7	3.1	4.7	4.9
2	1.4	1.5	2.8	4.1	4.3
2.5	1.5	1.7	3.1	4.6	4.7
3	1.2	1.3	2.4	3.6	3.7
3.5	1.3	1.4	2.6	3.9	4.0
4	1.4	1.6	2.9	4.4	4.5
5	1.9	2.1	3.8	5.8	6.0
6	1.5	1.6	2.9	4.4	4.6
8	2.1	2.3	4.1	6.3	6.5
10	1.5	1.7	3.0	4.6	4.7
12	2.1	2.4	4.4	6.5	6.8
13	2.5	2.9	5.3	7.8	8.1
15	2.1	2.4	4.4	6.5	6.7
16	2.2	2.6	4.7	6.9	7.2
20	3.2	3.6	6.6	9.8	10.1
25	3.0	3.5	6.4	9.4	9.7
32	3.7	4.4	8.1	12.1	12.5
40	3.4	4.1	7.5	11.2	11.5
50	4.5	5.4	9.9	14.9	15.3
63	5.2	6.3	11.5	17.2	17.7

*symmetrical load

Type D

I_n [A]	1p	1pN	2p	3p	3pN*
	P [W]	P [W]	P [W]	P [W]	P [W]
0.5	1.2	1.3	2.4	3.5	3.7
1	0.8	0.9	1.6	2.4	2.5
1.5	1.2	1.3	2.3	3.5	3.6
1.6	1.3	1.4	2.5	3.8	3.9
2	1.0	1.1	2.0	3.0	3.1
2.5	1.0	1.1	1.9	2.9	3.0
3	1.2	1.3	2.4	3.6	3.7
3.5	1.3	1.4	2.6	3.9	4.0
4	1.4	1.6	2.9	4.4	4.5
5	1.7	1.8	3.3	5.1	5.3
6	1.5	1.6	2.9	4.4	4.6
8	1.3	1.5	2.6	4.0	4.2
10	1.5	1.7	3.0	4.6	4.7
12	1.7	2.0	3.6	5.3	5.4
13	1.9	2.2	4.0	5.9	6.1
15	2.1	2.4	4.4	6.5	6.7
16	2.2	2.6	4.7	6.9	7.2
20	2.0	2.2	4.1	6.1	6.2
25	2.5	2.9	5.2	7.7	7.9
32	3.4	4.0	7.4	11.1	11.4
40	3.2	3.8	7.0	10.4	10.7

*symmetrical load

Influence of Ambient Temperature FAZ

On Load Carrying Capacity (temperature derating)

I _N [A]	Ambient temperature T [°C]																
	-40	-30	-20	-10	0	10	20	30	35	40	45	50	55	60	65	70	75
0.16	0.2	0.2	0.19	0.19	0.18	0.17	0.17	0.16	0.16	0.15	0.15	0.15	0.14	0.14	0.14	0.14	0.13
0.25	0.32	0.31	0.3	0.29	0.28	0.27	0.26	0.25	0.25	0.24	0.24	0.23	0.23	0.22	0.22	0.21	0.21
0.5	0.64	0.62	0.6	0.58	0.56	0.54	0.52	0.5	0.49	0.48	0.47	0.46	0.45	0.44	0.43	0.42	0.41
0.75	0.96	0.93	0.9	0.87	0.84	0.81	0.78	0.75	0.74	0.73	0.71	0.69	0.68	0.66	0.65	0.64	0.62
1	1.3	1.2	1.2	1.2	1.1	1.1	1	1	0.99	0.97	0.95	0.93	0.9	0.89	0.87	0.85	0.83
1.5	1.9	1.9	1.8	1.7	1.7	1.6	1.6	1.5	1.5	1.5	1.4	1.4	1.4	1.3	1.3	1.3	1.2
1.6	2	2	1.9	1.9	1.8	1.7	1.7	1.6	1.6	1.5	1.5	1.5	1.4	1.4	1.4	1.4	1.3
2	2.6	2.5	2.4	2.3	2.2	2.2	2.1	2	2	1.9	1.9	1.9	1.8	1.8	1.7	1.7	1.7
2.5	3.2	3.1	3	2.9	2.8	2.7	2.6	2.5	2.5	2.4	2.4	2.3	2.3	2.2	2.2	2.1	2.1
3	3.8	3.7	3.6	3.5	3.4	3.3	3.1	3	3	2.9	2.8	2.8	2.7	2.7	2.6	2.5	2.5
3.5	4.5	4.4	4.2	4.1	3.9	3.8	3.7	3.5	3.4	3.4	3.3	3.2	3.2	3.1	3	3	2.9
4	5.1	5	4.8	4.7	4.5	4.3	4.2	4	3.9	3.9	3.8	3.7	3.6	3.5	3.5	3.4	3.3
5	6.4	6.2	6	5.8	5.6	5.4	5.2	5	4.9	4.8	4.7	4.6	4.5	4.4	4.3	4.2	4.1
6	7.7	7.5	7.2	7	6.7	6.5	6.3	6	5.9	5.8	5.7	5.6	5.4	5.3	5.2	5.1	5
8	10.2	9.9	9.6	9.3	9	8.7	8.4	8	7.9	7.7	7.6	7.4	7.2	7.1	6.9	6.8	6.6
10	13	12	12	12	11	11	10	10	9.9	9.7	9.5	9.3	9	8.9	8.7	8.5	8.3
12	15	15	14	14	13	13	13	12	12	12	11	11	11	11	10	10	10
13	17	16	16	15	15	14	14	13	13	13	12	12	12	12	11	11	11
15	19	19	18	17	17	16	16	15	15	15	14	14	14	13	13	13	12
16	20	20	19	19	18	17	17	16	16	15	15	15	14	14	14	14	13
20	26	25	24	23	22	22	21	20	20	19	19	19	18	18	17	17	17
25	32	31	30	29	28	27	26	25	25	24	24	23	23	22	22	21	21
32	41	40	38	37	36	35	33	32	32	31	30	30	29	28	28	27	26
40	51	50	48	47	45	43	42	40	39	39	38	37	36	35	35	34	33
50	64	62	60	58	56	54	52	50	49	48	47	46	45	44	43	42	41
63	81	78	76	73	71	68	66	63	62	61	60	58	57	56	55	53	52

Maximum Let-Through Energy FAZ

Type B (IEC/EN60947-2)

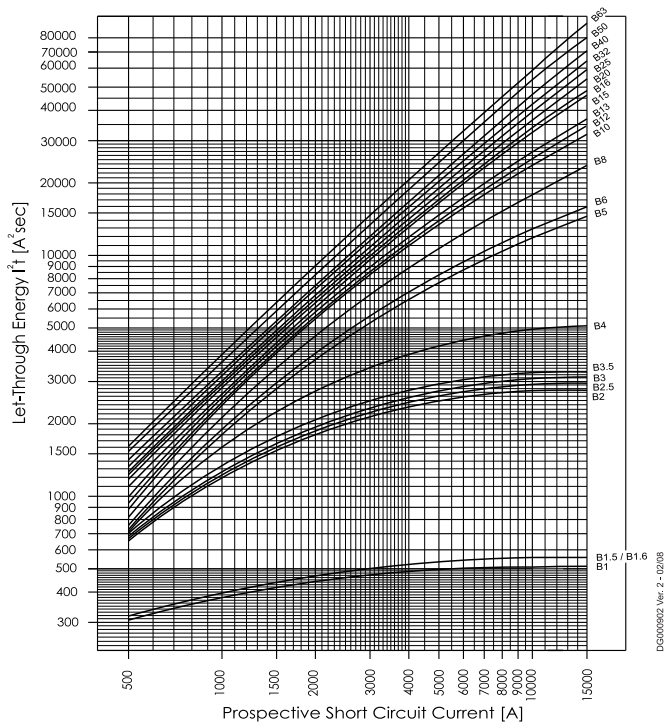

Type C (IEC/EN60947-2)

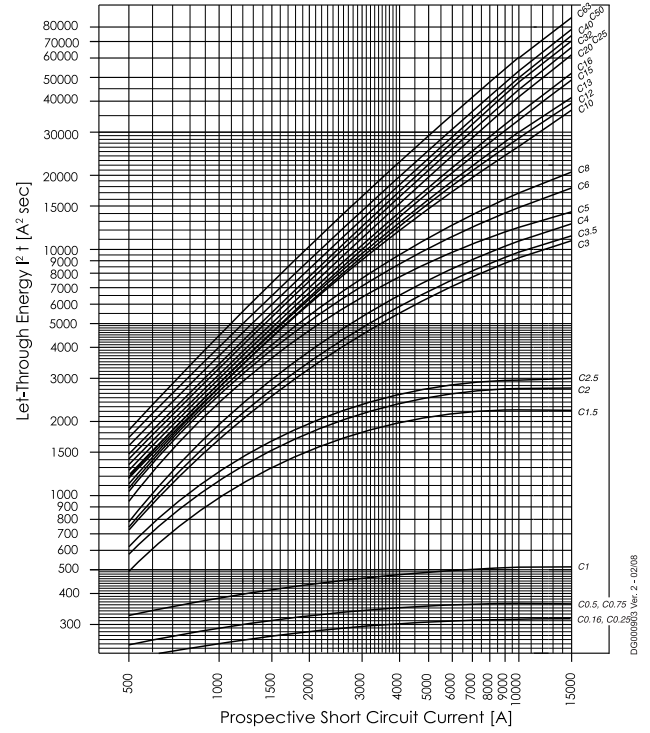

Type D (IEC/EN60947-2)

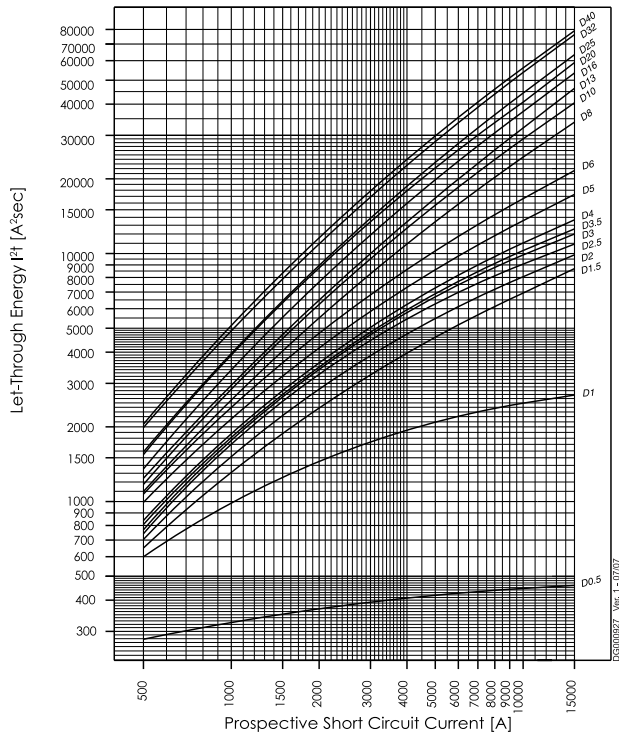

Type K

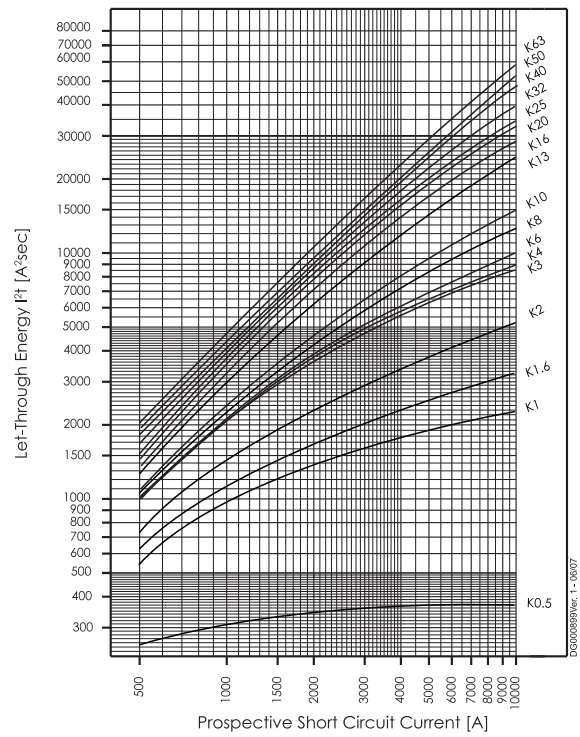

Maximum Let-Through Energy FAZ

Type S

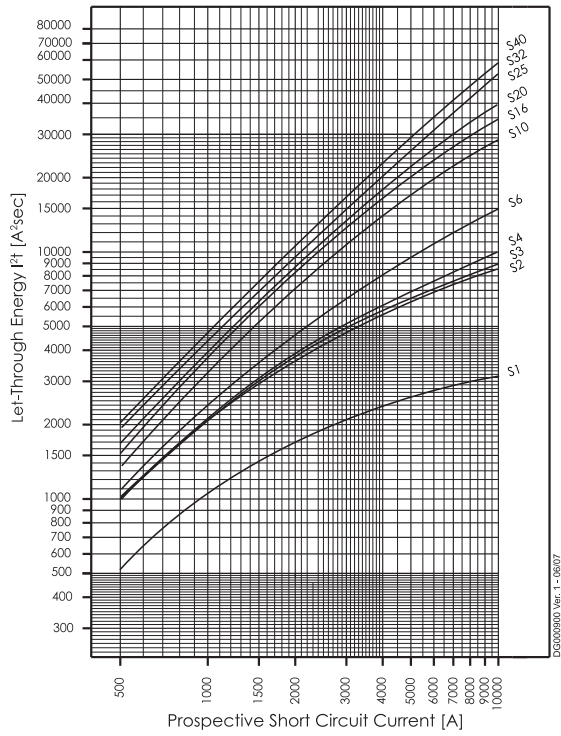

Type Z

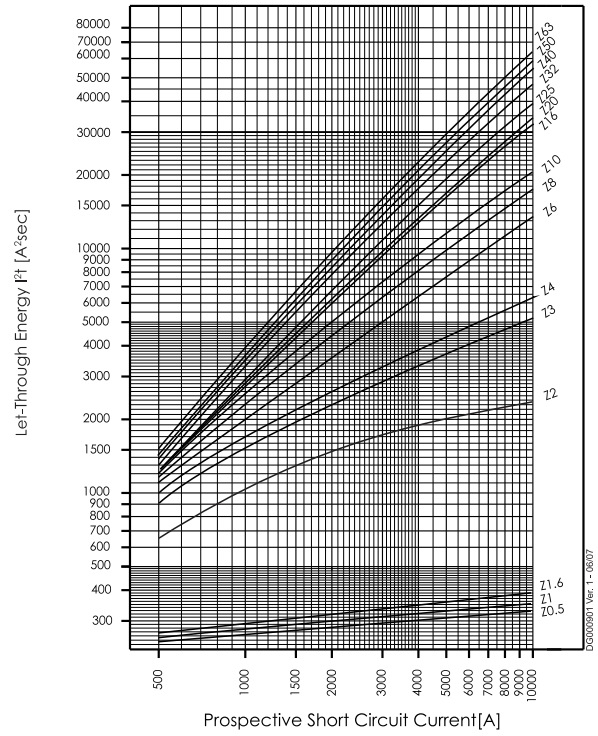

Type FAZ...-HS

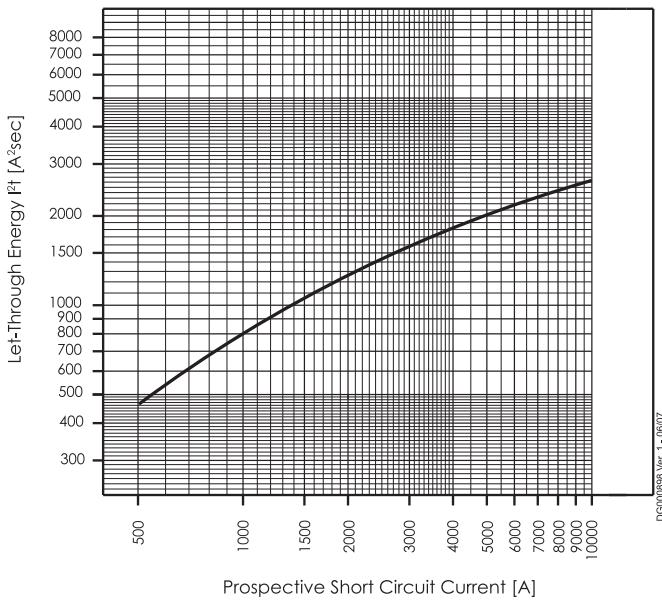

Maximum Let-Through Current FAZ

Type B (IEC/EN60898)

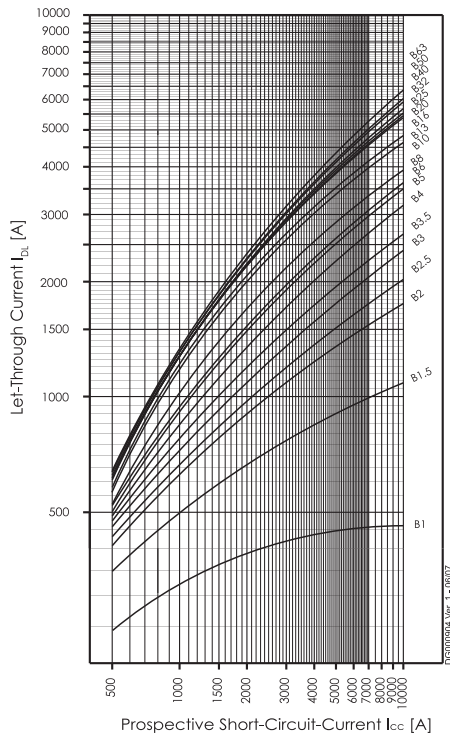

Type C (IEC/EN60898)

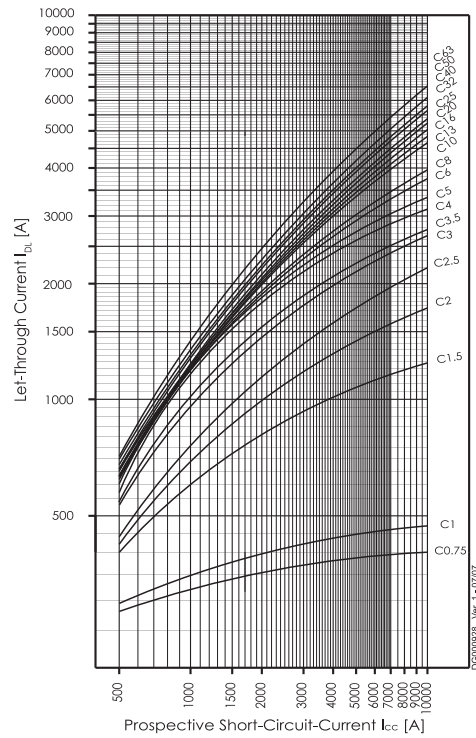

Type D (IEC/EN60898)

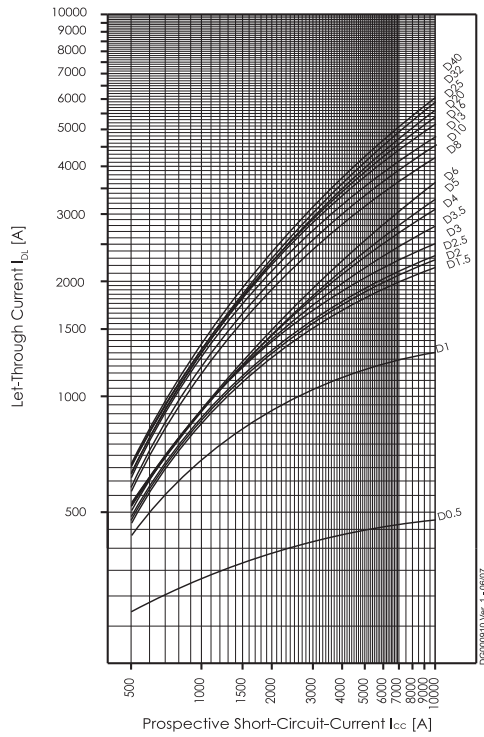

Type K

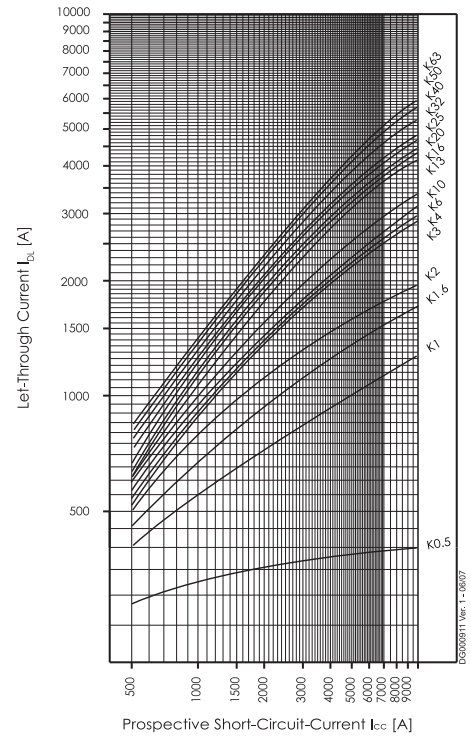

Short Circuit Selectivity FAZ

In case of short circuit, there is selectivity between the miniature circuit breakers FAZ and the upstream protection devices up to the specified values of the selectivity limit current I_s [kA] (i. e. in case of short-circuit currents I_{ks} under I_s , only the MCB will trip, in case of short circuit currents above this value both protective devices will respond).

*) basically in accordance with EN 60898-1 D.5.2.b

FAZ towards NH-00 Fuses

Short circuit selectivity **characteristic B** towards fuse link **NH-00***)

FAZ	NH-00 gL/gG											
I_n [A]	16	20	25	32	35	40	50	63	80	100	125	160
1.0	0.9	10.0 ²⁾	10.0 ²⁾	10.0 ²⁾	10.0 ²⁾	10.0 ²⁾	10.0 ²⁾	10.0 ²⁾	10.0 ²⁾	10.0 ²⁾	10.0 ²⁾	10.0 ²⁾
1.5	0.8	10.0 ²⁾	10.0 ²⁾	10.0 ²⁾	10.0 ²⁾	10.0 ²⁾	10.0 ²⁾	10.0 ²⁾	10.0 ²⁾	10.0 ²⁾	10.0 ²⁾	10.0 ²⁾
2.0	<0.5 ¹⁾	0.5	1.0	2.5	10.0 ²⁾	10.0 ²⁾	10.0 ²⁾	10.0 ²⁾	10.0 ²⁾	10.0 ²⁾	10.0 ²⁾	10.0 ²⁾
2.5	<0.5 ¹⁾	0.5	1.0	2.3	10.0 ²⁾	10.0 ²⁾	10.0 ²⁾	10.0 ²⁾	10.0 ²⁾	10.0 ²⁾	10.0 ²⁾	10.0 ²⁾
3.0	<0.5 ¹⁾	0.5	0.9	2.1	8.0	10.0 ²⁾	10.0 ²⁾	10.0 ²⁾	10.0 ²⁾	10.0 ²⁾	10.0 ²⁾	10.0 ²⁾
3.5	<0.5 ¹⁾	0.5	0.9	1.8	5.5	10.0 ²⁾	10.0 ²⁾	10.0 ²⁾	10.0 ²⁾	10.0 ²⁾	10.0 ²⁾	10.0 ²⁾
4	<0.5 ¹⁾	<0.5 ¹⁾	0.8	1.3	2.3	4.3	10.0 ²⁾	10.0 ²⁾	10.0 ²⁾	10.0 ²⁾	10.0 ²⁾	10.0 ²⁾
5	<0.5 ¹⁾	<0.5 ¹⁾	0.7	1.1	1.6	2.2	3.6	4.8	8.9	10.0 ²⁾	10.0 ²⁾	10.0 ²⁾
6	<0.5 ¹⁾	<0.5 ¹⁾	0.7	1.1	1.5	2.0	3.3	4.3	7.6	10.0 ²⁾	10.0 ²⁾	10.0 ²⁾
8	<0.5 ¹⁾	<0.5 ¹⁾	0.6	1.0	1.3	1.7	2.6	3.3	5.2	10.0 ²⁾	10.0 ²⁾	10.0 ²⁾
10		<0.5 ¹⁾	0.6	0.9	1.2	1.5	2.2	2.7	4.0	9.0	10.0 ²⁾	10.0 ²⁾
13		<0.5 ¹⁾	0.6	0.8	1.1	1.4	2.1	2.6	3.8	7.9	10.0 ²⁾	10.0 ²⁾
16			0.5	0.7	1.0	1.3	1.9	2.4	3.4	6.4	9.3	10.0 ²⁾
20				0.7	1.0	1.3	1.9	2.4	3.3	6.0	8.7	10.0 ²⁾
25				0.7	1.0	1.3	1.8	2.3	3.2	5.7	8.0	10.0 ²⁾
32					0.9	1.2	1.7	2.2	3.1	5.4	7.6	10.0 ²⁾
40								2.1	3.0	5.1	7.2	10.0 ²⁾
50								1.9	2.8	4.7	6.6	9.5
63										4.4	6.3	8.6

Short circuit selectivity **characteristic C** towards fuse link **NH-00***)

FAZ	NH-00 gL/gG											
I_n [A]	16	20	25	32	35	40	50	63	80	100	125	160
0.75	10.0 ²⁾	10.0 ²⁾	10.0 ²⁾	10.0 ²⁾	10.0 ²⁾	10.0 ²⁾	10.0 ²⁾	10.0 ²⁾	10.0 ²⁾	10.0 ²⁾	10.0 ²⁾	10.0 ²⁾
1.0	0.9	10.0 ²⁾	10.0 ²⁾	10.0 ²⁾	10.0 ²⁾	10.0 ²⁾	10.0 ²⁾	10.0 ²⁾	10.0 ²⁾	10.0 ²⁾	10.0 ²⁾	10.0 ²⁾
1.5	<0.5 ¹⁾	0.6	1.3	4.2	10.0 ²⁾	10.0 ²⁾	10.0 ²⁾	10.0 ²⁾	10.0 ²⁾	10.0 ²⁾	10.0 ²⁾	10.0 ²⁾
2.0	<0.5 ¹⁾	0.6	1.0	2.5	10.0 ²⁾	10.0 ²⁾	10.0 ²⁾	10.0 ²⁾	10.0 ²⁾	10.0 ²⁾	10.0 ²⁾	10.0 ²⁾
2.5	<0.5 ¹⁾	0.5	1.0	2.1	10.0 ²⁾	10.0 ²⁾	10.0 ²⁾	10.0 ²⁾	10.0 ²⁾	10.0 ²⁾	10.0 ²⁾	10.0 ²⁾
3.0	<0.5 ¹⁾	<0.5 ¹⁾	0.7	1.2	1.8	2.6	4.7	6.6	10.0 ²⁾	10.0 ²⁾	10.0 ²⁾	10.0 ²⁾
3.5	<0.5 ¹⁾	<0.5 ¹⁾	0.7	1.1	1.7	2.4	4.2	6.0	10.0 ²⁾	10.0 ²⁾	10.0 ²⁾	10.0 ²⁾
4	<0.5 ¹⁾	<0.5 ¹⁾	0.7	1.0	1.5	2.1	3.6	5.0	10.0	10.0 ²⁾	10.0 ²⁾	10.0 ²⁾
5	<0.5 ¹⁾	<0.5 ¹⁾	0.6	0.8	1.2	1.7	2.8	3.8	8.7	10.0 ²⁾	10.0 ²⁾	10.0 ²⁾
6	<0.5 ¹⁾	<0.5 ¹⁾	0.5	0.8	1.2	1.5	2.5	3.3	5.7	10.0 ²⁾	10.0 ²⁾	10.0 ²⁾
8	<0.5 ¹⁾	<0.5 ¹⁾	0.5	0.8	1.1	1.5	2.3	2.9	4.9	10.0 ²⁾	10.0 ²⁾	10.0 ²⁾
10			0.5	0.7	1.0	1.4	2.0	2.5	3.8	8.0	10.0 ²⁾	10.0 ²⁾
13					1.0	1.3	1.9	2.4	3.6	7.0	10.0 ²⁾	10.0 ²⁾
16					1.0	1.3	1.8	2.3	3.3	6.0	8.8	10.0 ²⁾
20					1.0	1.2	1.7	2.2	3.2	5.5	7.7	10.0 ²⁾
25						1.6	2.1	3.0	5.2	7.3	10.0 ²⁾	
32							2.1	2.9	5.0	7.0	10.0 ²⁾	
40								2.8	4.8	6.7	10.0	
50									4.5	6.3	9.5	
63										5.9	8.4	

Short circuit selectivity **characteristic D** towards fuse link **NH-00***)

FAZ	NH-00 gL/gG											
I_n [A]	16	20	25	32	35	40	50	63	80	100	125	160
0.5	2.1	10.0 ²⁾	10.0 ²⁾	10.0 ²⁾	10.0 ²⁾	10.0 ²⁾	10.0 ²⁾	10.0 ²⁾	10.0 ²⁾	10.0 ²⁾	10.0 ²⁾	10.0 ²⁾
1.0	<0.5 ¹⁾	0.6	1.4	4.3	10.0 ²⁾	10.0 ²⁾	10.0 ²⁾	10.0 ²⁾	10.0 ²⁾	10.0 ²⁾	10.0 ²⁾	10.0 ²⁾
1.5	<0.5 ¹⁾	<0.5 ¹⁾	0.9	1.6	2.7	4.0	8.0	10.0 ²⁾	10.0 ²⁾	10.0 ²⁾	10.0 ²⁾	10.0 ²⁾
2.0	<0.5 ¹⁾	<0.5 ¹⁾	0.8	1.3	2.1	3.1	6.0	8.6	10.0 ²⁾	10.0 ²⁾	10.0 ²⁾	10.0 ²⁾
2.5	<0.5 ¹⁾	<0.5 ¹⁾	0.7	1.2	1.8	2.6	4.8	6.9	10.0 ²⁾	10.0 ²⁾	10.0 ²⁾	10.0 ²⁾
3.0	<0.5 ¹⁾	<0.5 ¹⁾	0.7	1.1	1.7	2.4	4.3	6.0	10.0 ²⁾	10.0 ²⁾	10.0 ²⁾	10.0 ²⁾
3.5	<0.5 ¹⁾	<0.5 ¹⁾	0.7	1.1	1.7	2.4	4.2	5.6	10.0 ²⁾	10.0 ²⁾	10.0 ²⁾	10.0 ²⁾
4	<0.5 ¹⁾	<0.5 ¹⁾	0.7	1.0	1.6	2.2	3.8	5.2	10.0	10.0 ²⁾	10.0 ²⁾	10.0 ²⁾
5		<0.5 ¹⁾	0.6	0.9	1.4	1.9	3.2	4.1	7.1	10.0 ²⁾	10.0 ²⁾	10.0 ²⁾
6		<0.5 ¹⁾	0.5	0.8	1.2	1.6	2.6	3.3	5.5	10.0 ²⁾	10.0 ²⁾	10.0 ²⁾
8			0.5	0.8	1.1	1.5	2.2	2.7	4.1	8.7	10.0 ²⁾	10.0 ²⁾
10			0.5	0.7	1.0	1.3	1.9	2.5	3.6	7.2	10.0 ²⁾	10.0 ²⁾
13				1.0	1.3	1.9	2.3	3.4	6.5	9.5	10.0 ²⁾	
16					1.1	1.6	2.0	3.0	5.5	8.0	10.0 ²⁾	
20						1.4	1.8	2.8	5.0	7.5	10.0 ²⁾	
25							1.8	2.7	4.8	7.0	10.0 ²⁾	
32								2.4	4.1	6.2	9.3	
40									4.0	6.0	9.0	

¹⁾ Selectivity limit current I_s under 0.5 kA

²⁾ Selectivity limit current I_s = rated breaking capacity I_{cn} of the MCB

Shaded fields: no selectivity

FAZ towards D01-D03 fuse link

Short circuit selectivity **characteristic B** towards fuse link **D01-D03***)

FAZ	D01-D03 gL/gG									
	I _n [A]	10	16	20	25	35	50	63	80	100
1.0	<0.5 ¹⁾	10.0 ²⁾	10.0 ²⁾	10.0 ²⁾	10.0 ²⁾	10.0 ²⁾	10.0 ²⁾	10.0 ²⁾	10.0 ²⁾	10.0 ²⁾
1.5	<0.5 ¹⁾	4.1	10.0 ²⁾	10.0 ²⁾	10.0 ²⁾	10.0 ²⁾	10.0 ²⁾	10.0 ²⁾	10.0 ²⁾	10.0 ²⁾
2.0	<0.5 ¹⁾	<0.5 ¹⁾	0.6	1.0	10.0 ²⁾	10.0 ²⁾	10.0 ²⁾	10.0 ²⁾	10.0 ²⁾	10.0 ²⁾
2.5	<0.5 ¹⁾	<0.5 ¹⁾	0.6	1.0	10.0 ²⁾	10.0 ²⁾	10.0 ²⁾	10.0 ²⁾	10.0 ²⁾	10.0 ²⁾
3.0	<0.5 ¹⁾	<0.5 ¹⁾	0.5	1.0	10.0 ²⁾	10.0 ²⁾	10.0 ²⁾	10.0 ²⁾	10.0 ²⁾	10.0 ²⁾
3.5	<0.5 ¹⁾	<0.5 ¹⁾	0.5	0.9	7.0	10.0 ²⁾	10.0 ²⁾	10.0 ²⁾	10.0 ²⁾	10.0 ²⁾
4	<0.5 ¹⁾	<0.5 ¹⁾	0.5	0.9	2.5	10.0 ²⁾	10.0 ²⁾	10.0 ²⁾	10.0 ²⁾	10.0 ²⁾
5		<0.5 ¹⁾	0.5	0.8	1.7	4.0	7.0	10.0 ²⁾	10.0 ²⁾	10.0 ²⁾
6		<0.5 ¹⁾	0.5	0.8	1.6	3.6	6.0	10.0 ²⁾	10.0 ²⁾	10.0 ²⁾
8			0.5	0.8	1.4	2.8	4.3	8.2	10.0 ²⁾	10.0 ²⁾
10			0.5	0.7	1.3	2.4	3.4	6.0	10.0 ²⁾	10.0 ²⁾
13			<0.5 ¹⁾	0.7	1.2	2.3	3.2	5.3	10.0 ²⁾	10.0 ²⁾
16				0.6	1.1	2.2	2.9	4.6	10.0	10.0
20					1.1	2.1	2.8	4.4	9.3	9.3
25					1.1	2.0	2.7	4.2	8.7	8.7
32						2.0	2.6	4.0	8.0	8.0
40							2.5	3.8	7.5	7.5
50							2.3	3.4	6.7	6.7
63									6.2	6.2

Short circuit selectivity **characteristic C** towards fuse link **D01-D03***)

FAZ	D01-D03 gL/gG									
	I _n [A]	10	16	20	25	35	50	63	80	100
0.75	<0.5 ¹⁾	10.0 ²⁾	10.0 ²⁾	10.0 ²⁾	10.0 ²⁾	10.0 ²⁾	10.0 ²⁾	10.0 ²⁾	10.0 ²⁾	10.0 ²⁾
1.0	<0.5 ¹⁾	10.0 ²⁾	10.0 ²⁾	10.0 ²⁾	10.0 ²⁾	10.0 ²⁾	10.0 ²⁾	10.0 ²⁾	10.0 ²⁾	10.0 ²⁾
1.5	<0.5 ¹⁾	0.5	0.6	0.9	10.0 ²⁾	10.0 ²⁾	10.0 ²⁾	10.0 ²⁾	10.0 ²⁾	10.0 ²⁾
2.0	<0.5 ¹⁾	<0.5 ¹⁾	0.5	0.7	10.0 ²⁾	10.0 ²⁾	10.0 ²⁾	10.0 ²⁾	10.0 ²⁾	10.0 ²⁾
2.5	<0.5 ¹⁾	<0.5 ¹⁾	0.5	0.7	10.0 ²⁾	10.0 ²⁾	10.0 ²⁾	10.0 ²⁾	10.0 ²⁾	10.0 ²⁾
3.0	<0.5 ¹⁾	<0.5 ¹⁾	<0.5 ¹⁾	0.6	1.9	5.2	10.0 ²⁾	10.0 ²⁾	10.0 ²⁾	10.0 ²⁾
3.5	<0.5 ¹⁾	<0.5 ¹⁾	<0.5 ¹⁾	0.6	1.8	4.7	9.5	10.0 ²⁾	10.0 ²⁾	10.0 ²⁾
4	<0.5 ¹⁾	<0.5 ¹⁾	<0.5 ¹⁾	0.6	1.6	4.0	7.6	10.0 ²⁾	10.0 ²⁾	10.0 ²⁾
5		<0.5 ¹⁾	<0.5 ¹⁾	0.5	1.3	3.1	5.7	10.0 ²⁾	10.0 ²⁾	10.0 ²⁾
6		<0.5 ¹⁾	<0.5 ¹⁾	<0.5 ¹⁾	1.2	2.7	4.5	10.0 ²⁾	10.0 ²⁾	10.0 ²⁾
8		<0.5 ¹⁾	<0.5 ¹⁾	<0.5 ¹⁾	1.2	2.5	4.0	8.6	10.0 ²⁾	10.0 ²⁾
10			<0.5 ¹⁾	<0.5 ¹⁾	1.2	2.3	3.1	5.4	10.0 ²⁾	10.0 ²⁾
13					1.1	2.2	3.0	4.9	10.0 ²⁾	10.0 ²⁾
16					1.1	2.1	2.8	4.4	9.5	9.5
20					1.0	2.0	2.6	4.0	8.3	8.3
25						1.9	2.5	3.8	7.8	7.8
32							2.5	3.7	7.3	7.3
40								3.5	7.0	7.0
50									6.5	6.5
63										6.2

Short circuit selectivity **characteristic D** towards fuse link **D01-D03***)

FAZ	D01-D03 gL/gG									
	I _n [A]	10	16	20	25	35	50	63	80	100
0.5	<0.5 ¹⁾	10.0 ²⁾	10.0 ²⁾	10.0 ²⁾	10.0 ²⁾	10.0 ²⁾	10.0 ²⁾	10.0 ²⁾	10.0 ²⁾	10.0 ²⁾
1.0	<0.5 ¹⁾	<0.5 ¹⁾	0.7	1.3	10.0 ²⁾	10.0 ²⁾	10.0 ²⁾	10.0 ²⁾	10.0 ²⁾	10.0 ²⁾
1.5	<0.5 ¹⁾	<0.5 ¹⁾	0.6	0.9	2.8	9.0	10.0 ²⁾	10.0 ²⁾	10.0 ²⁾	10.0 ²⁾
2.0	<0.5 ¹⁾	<0.5 ¹⁾	0.6	0.8	2.2	6.7	10.0 ²⁾	10.0 ²⁾	10.0 ²⁾	10.0 ²⁾
2.5	<0.5 ¹⁾	<0.5 ¹⁾	0.5	0.7	1.9	5.4	10.0 ²⁾	10.0 ²⁾	10.0 ²⁾	10.0 ²⁾
3.0	<0.5 ¹⁾	<0.5 ¹⁾	0.5	0.7	1.8	4.8	9.3	10.0 ²⁾	10.0 ²⁾	10.0 ²⁾
3.5	<0.5 ¹⁾	<0.5 ¹⁾	0.5	0.7	1.7	4.7	8.6	10.0 ²⁾	10.0 ²⁾	10.0 ²⁾
4		<0.5 ¹⁾	0.5	0.7	1.7	4.6	7.7	10.0 ²⁾	10.0 ²⁾	10.0 ²⁾
5		<0.5 ¹⁾	<0.5 ¹⁾	0.6	1.5	3.5	5.8	10.0 ²⁾	10.0 ²⁾	10.0 ²⁾
6			<0.5 ¹⁾	0.5	1.3	2.9	4.5	9.0	10.0 ²⁾	10.0 ²⁾
8			<0.5 ¹⁾	0.5	1.2	2.4	3.5	6.0	10.0 ²⁾	10.0 ²⁾
10				0.5	1.1	2.2	3.0	5.0	10.0 ²⁾	10.0 ²⁾
13					1.1	2.1	2.9	4.6	10.0 ²⁾	10.0 ²⁾
16						1.9	2.6	3.9	9.0	9.0
20						1.7	2.3	3.5	8.0	8.0
25							2.2	3.4	7.5	7.5
32								2.9	6.0	6.0
40									5.7	5.7

¹⁾ Selectivity limit current I_s under 0.5 kA

²⁾ Selectivity limit current I_s = rated breaking capacity I_{cn} of the MCB

Shaded fields: no selectivity

FAZ towards DII-DIV fuse link

Short circuit selectivity **characteristic B** towards fuse link **DII-DIV***)

FAZ	DII-DIV gL/gG								
I_n [A]	10	16	20	25	35	50	63	80	100
1.0	<0.5 ¹⁾	1.2	10.0 ²⁾	10.0 ²⁾	10.0 ²⁾	10.0 ²⁾	10.0 ²⁾	10.0 ²⁾	10.0 ²⁾
1.5	<0.5 ¹⁾	1.0	10.0 ²⁾	10.0 ²⁾	10.0 ²⁾	10.0 ²⁾	10.0 ²⁾	10.0 ²⁾	10.0 ²⁾
2.0	<0.5 ¹⁾	<0.5 ¹⁾	0.8	1.6	10.0 ²⁾	10.0 ²⁾	10.0 ²⁾	10.0 ²⁾	10.0 ²⁾
2.5	<0.5 ¹⁾	<0.5 ¹⁾	0.8	1.5	10.0 ²⁾	10.0 ²⁾	10.0 ²⁾	10.0 ²⁾	10.0 ²⁾
3.0	<0.5 ¹⁾	<0.5 ¹⁾	0.8	1.4	10.0 ²⁾	10.0 ²⁾	10.0 ²⁾	10.0 ²⁾	10.0 ²⁾
3.5	<0.5 ¹⁾	<0.5 ¹⁾	0.7	1.3	10.0 ²⁾	10.0 ²⁾	10.0 ²⁾	10.0 ²⁾	10.0 ²⁾
4	<0.5 ¹⁾	<0.5 ¹⁾	0.6	1.0	3.6	10.0 ²⁾	10.0 ²⁾	10.0 ²⁾	10.0 ²⁾
5	<0.5 ¹⁾	<0.5 ¹⁾	0.6	0.9	2.0	3.5	8.5	10.0 ²⁾	10.0 ²⁾
6		<0.5 ¹⁾	0.6	0.9	1.8	3.2	7.4	10.0 ²⁾	10.0 ²⁾
8		<0.5 ¹⁾	0.5	0.8	1.6	2.6	5.2	8.3	10.0 ²⁾
10			0.5	0.8	1.4	2.2	3.9	6.0	10.0 ²⁾
13			0.5	0.7	1.3	2.0	3.6	5.4	10.0 ²⁾
16				0.6	1.2	1.9	3.2	4.6	8.4
20					1.2	1.8	3.1	4.4	7.8
25					1.2	1.8	3.0	4.2	7.3
32						1.7	2.8	3.9	6.8
40							2.7	3.8	6.5
50							2.5	3.5	5.7
63									5.3

Short circuit selectivity **characteristic C** towards fuse link **DII-DIV***)

FAZ	DII-DIV gL/gG								
I_n [A]	10	16	20	25	35	50	63	80	100
0.75	1.0	10.0 ²⁾	10.0 ²⁾	10.0 ²⁾	10.0 ²⁾	10.0 ²⁾	10.0 ²⁾	10.0 ²⁾	10.0 ²⁾
1.0	<0.5 ¹⁾	1.2	10.0 ²⁾	10.0 ²⁾	10.0 ²⁾	10.0 ²⁾	10.0 ²⁾	10.0 ²⁾	10.0 ²⁾
1.5	<0.5 ¹⁾	<0.5 ¹⁾	1.0	2.2	10.0 ²⁾	10.0 ²⁾	10.0 ²⁾	10.0 ²⁾	10.0 ²⁾
2.0	<0.5 ¹⁾	<0.5 ¹⁾	0.8	1.6	10.0 ²⁾	10.0 ²⁾	10.0 ²⁾	10.0 ²⁾	10.0 ²⁾
2.5	<0.5 ¹⁾	<0.5 ¹⁾	0.8	1.4	10.0 ²⁾	10.0 ²⁾	10.0 ²⁾	10.0 ²⁾	10.0 ²⁾
3.0	<0.5 ¹⁾	<0.5 ¹⁾	0.8	0.9	10.0 ²⁾	10.0 ²⁾	10.0 ²⁾	10.0 ²⁾	10.0 ²⁾
3.5	<0.5 ¹⁾	<0.5 ¹⁾	0.6	0.9	2.2	4.5	10.0 ²⁾	10.0 ²⁾	10.0 ²⁾
4	<0.5 ¹⁾	<0.5 ¹⁾	0.6	0.8	1.8	3.6	9.7	10.0 ²⁾	10.0 ²⁾
5	<0.5 ¹⁾	<0.5 ¹⁾	0.6	0.7	1.5	2.7	7.3	10.0 ²⁾	10.0 ²⁾
6		<0.5 ¹⁾	0.5	0.6	1.4	2.4	5.5	10.0 ²⁾	10.0 ²⁾
8		<0.5 ¹⁾	<0.5 ¹⁾	0.6	1.3	2.2	4.7	8.7	10.0 ²⁾
10			<0.5 ¹⁾	0.6	1.3	2.0	3.6	5.4	10.0 ²⁾
13					1.3	1.9	3.3	5.0	9.4
16					1.2	1.8	3.2	4.4	8.0
20					1.2	1.8	3.1	4.1	7.0
25						1.7	2.8	3.8	6.5
32							2.7	3.7	6.2
40								3.5	5.9
50									5.5
63									

Short circuit selectivity **characteristic D** towards fuse link **DII-DIV***)

FAZ	DII-DIV gL/gG								
I_n [A]	10	16	20	25	35	50	63	80	100
0.5	0.5	3.0	10.0 ²⁾	10.0 ²⁾	10.0 ²⁾	10.0 ²⁾	10.0 ²⁾	10.0 ²⁾	10.0 ²⁾
1.0	<0.5 ¹⁾	<0.5 ¹⁾	1.0	2.4	10.0 ²⁾	10.0 ²⁾	10.0 ²⁾	10.0 ²⁾	10.0 ²⁾
1.5	<0.5 ¹⁾	<0.5 ¹⁾	0.7	1.2	3.5	7.7	10.0 ²⁾	10.0 ²⁾	10.0 ²⁾
2.0	<0.5 ¹⁾	<0.5 ¹⁾	0.6	1.0	2.8	5.8	10.0 ²⁾	10.0 ²⁾	10.0 ²⁾
2.5	<0.5 ¹⁾	<0.5 ¹⁾	0.6	1.4	2.3	4.6	10.0 ²⁾	10.0 ²⁾	10.0 ²⁾
3.0	<0.5 ¹⁾	<0.5 ¹⁾	0.6	0.9	2.3	4.3	10.0 ²⁾	10.0 ²⁾	10.0 ²⁾
3.5	<0.5 ¹⁾	<0.5 ¹⁾	0.6	0.9	2.1	4.0	10.0 ²⁾	10.0 ²⁾	10.0 ²⁾
4		<0.5 ¹⁾	0.6	0.9	2.0	3.8	9.5	10.0 ²⁾	10.0 ²⁾
5		<0.5 ¹⁾	0.5	0.7	1.7	3.1	7.0	10.0 ²⁾	10.0 ²⁾
6			0.5	0.7	1.5	2.6	5.3	9.1	10.0 ²⁾
8			<0.5 ¹⁾	0.7	1.4	2.2	3.9	6.0	10.0 ²⁾
10				0.7	1.2	1.9	3.4	5.0	9.5
13					1.2	1.8	3.2	4.6	8.6
16						1.6	2.7	4.0	7.4
20						1.5	2.5	3.5	6.7
25							2.4	3.4	6.2
32								2.8	5.0
40									4.8

¹⁾ Selectivity limit current I_s under 0.5 kA

²⁾ Selectivity limit current $I_s =$ rated breaking capacity I_{cn} of the MCB

Shaded fields: no selectivity

FAZ-B and NZM 1/2

Selectivity-limit current I_g [kA] for selectivity between FAZ-B and NZM (overload and short-circuit release unit NZM at max. value).

I_n [A]	NZM...1-A...						NZM...2-A...								
	$I_{cu} = 25 (50) \text{ kA}$						$I_{cu} = 25 (50)(100)(150) \text{ kA}$								
FAZ-B	40	50	63	80	100	125	40	50	63	80	100	125	160	200	250
1	15	15	15	15	15	15	15	15	15	15	15	15	15	15	15
2	2	15	15	15	15	15	3	15	15	15	15	15	15	15	15
3	1.2	2	3	3	10	15	1.5	1.5	3	5	15	15	15	15	15
4	1.2	2	3	3	8	15	1.2	1.5	3	4	15	15	15	15	15
6	1.2	2	2.5	3	5	10	1.2	1.5	2.5	3	15	15	15	15	15
10	1.2	1.5	2	2	4	10	1	1.5	2.5	3	10	10	10	10	10
13	1	1.5	2	2	4	10	1	1.2	2	3	10	10	10	10	10
16	1	1.2	1.5	2	3	8	1	1.2	1.5	2.5	10	10	10	10	10
20	0.8	1.2	1.5	1.5	3	8	1	1.2	1.5	1.5	10	10	10	10	10
25	0.7	1.2	1.5	1.5	3	7	0.8	1	1.5	2	10	10	10	10	10
32	-	1.2	1	1.5	2	6	-	1	1.5	2	8	8	8	8	10
40	-	-	1	1.5	2	5	-	-	1.2	1.5	7	7	7	7	10
50	-	-	-	1.2	1.5	4	-	-	-	1.5	6	6	6	6	10
63	-	-	-	-	1.5	3	-	-	-	-	6	6	6	6	10

FAZ-C and NZM 1/2

Selectivity-limit current I_g [kA] for selectivity between FAZ-C and NZM (overload and short-circuit release unit NZM at max. value).

I_n [A]	NZM...1-A...						NZM...2-A...								
	$I_{cu} = 25 (50) \text{ kA}$						$I_{cu} = 25 (50)(100)(150) \text{ kA}$								
FAZ-C	40	50	63	80	100	125	40	50	63	80	100	125	160	200	250
0.5	15	15	15	15	15	15	15	15	15	15	15	15	15	15	15
1	15	15	15	15	15	15	15	15	15	15	15	15	15	15	15
2	2	15	15	15	15	15	3	15	15	15	15	15	15	15	15
3	1.2	2	3	3	10	15	1.5	1.5	3	5	15	15	15	15	15
4	1.2	2	3	3	8	15	1.2	1.5	3	4	15	15	15	15	15
6	1.2	2	2.5	3	5	10	1.2	1.5	2.5	3	15	15	15	15	15
10	1.2	1.5	2	2	4	10	1	1.5	2.5	3	10	10	10	10	10
13	1	1.5	2	2	4	10	1	1.2	2	3	10	10	10	10	10
16	1	1.2	1.5	2	3	8	1	1.2	1.5	2.5	10	10	10	10	10
20	0.8	1.2	1.5	1.5	3	8	1	1.2	1.5	1.5	10	10	10	10	10
25	0.7	1.2	1.5	1.5	3	7	0.8	1	1.5	2	10	10	10	10	10
32	-	1.2	1	1.5	2	6	-	1	1.5	2	8	8	8	8	10
40	-	-	1	1.5	2	5	-	-	1.2	1.5	7	7	7	7	10
50	-	-	-	1.2	1.5	4	-	-	-	1.5	6	6	6	6	10
63	-	-	-	-	1.5	3	-	-	-	-	6	6	6	6	10

FAZ-D and NZM 1/2

Selectivity-limit current I_s [kA] for selectivity between FAZ-D and NZM (overload and short-circuit release unit NZM at max. value).

I_n [A]	NZM...1-A...						NZM...2-A...								
	$I_{cu} = 25 (50) \text{ kA}$						$I_{cu} = 25 (50)(100)(150) \text{ kA}$								
FAZ-D	40	50	63	80	100	125	40	50	63	80	100	125	160	200	250
0.5	9	15	15	15	15	15	9	15	15	15	15	15	15	15	15
1	0.5	0.7	1.1	1.9	4.2	15	0.5	0.7	1.1	1.9	4.2	15	15	15	15
1.5	0.3	0.6	0.8	1.1	1.6	2.6	0.3	0.6	0.8	1.1	1.6	2.6	5	15	15
2	0.3	0.5	0.75	0.95	1.4	2.4	0.3	0.5	0.75	0.95	1.4	2.4	4.5	10	15
2.5	0.3	0.5	0.75	0.95	1.3	2.3	0.3	0.5	0.75	0.95	1.3	2.3	4.2	9	15
3	0.3	0.5	0.7	0.9	1.3	2.1	0.3	0.5	0.7	0.9	1.3	2.1	3.6	7	15
3.5	0.3	0.5	0.7	0.9	1.3	2	0.3	0.5	0.7	0.9	1.3	2	3.3	5.6	10
4	0.3	0.5	0.7	0.9	1.3	1.9	0.3	0.5	0.7	0.9	1.3	1.9	3	4.7	8
5	0.3	0.5	0.7	0.9	1.3	1.9	0.3	0.5	0.7	0.9	1.3	1.9	3	4.4	7
6	0.3	0.5	0.6	0.9	1.3	1.8	0.3	0.5	0.6	0.9	1.3	1.8	2.8	4	6
8	0.3	0.3	0.6	0.75	1	1.3	0.3	0.3	0.6	0.75	1	1.3	1.8	2.7	4
10	0.3	0.3	0.6	0.75	0.95	1.2	0.3	0.3	0.6	0.75	0.95	1.2	1.7	2.4	3.6
13	0.3	0.3	0.5	0.7	0.9	1.1	0.3	0.3	0.5	0.7	0.9	1.1	1.6	2.2	3.2
16	-	0.3	0.5	0.65	0.8	1.1	-	0.3	0.5	0.65	0.8	1.1	1.5	2.1	3
20	-	-	0.5	0.65	0.8	1.1	-	-	0.5	0.65	0.8	1.1	1.4	2.1	3
25	-	-	0.5	0.65	0.8	1.1	-	-	0.5	0.65	0.8	1.1	1.4	1.9	2.7
32	-	-	-	-	0.8	1.1	-	-	-	-	0.8	1.1	1.4	1.9	2.7
40	-	-	-	-	-	1	-	-	-	-	-	1	1.4	1.8	2.6

Back-up Protection FAZ

The up-stream protective devices will protect the down-stream FAZ up to the short-circuit current specified.

FAZ/C and AZ/C

I_n [A]	AZ/C								
	I_n [A]								
FAZ/C	20	25	32	40	50	63	80	100	125
1	25	25	25	25	25	25	20	20	15 kA
2	25	25	25	25	25	25	20	20	15 kA
4	25	25	25	25	25	25	20	20	15 kA
6	25	25	25	25	25	25	20	20	15 kA
10	25	25	25	25	25	25	20	20	15 kA
13	25	25	25	25	25	25	20	20	15 kA
16	25	25	25	25	25	25	20	20	15 kA
20	1)	25	25	25	25	25	20	20	15 kA
25	1)	1)	25	25	25	25	20	20	15 kA
32	1)	1)	1)	25	25	25	20	20	-
40	1)	1)	1)	1)	25	25	20	20	-
50	1)	1)	1)	1)	1)	25	20	20	-
63	1)	1)	1)	1)	1)	1)	-	-	-

1) I_n (AZ) \leq I_n (FAZ)

FAZ and CL-PKZ0

Back-up tests acc. to EN/IEC 60947-2, App. A: $U = 1.05 U_e$, (O - t - CO)

I_n [A]	FAZ- I_n /1(2,3,4)/B(C) + CL-PKZ0 $U_e = 230/400 V$
0.16	65 kA
0.25	65 kA
0.5	65 kA
0.75	65 kA
1	65 kA
1.5	65 kA
2	65 kA
2.5	65 kA
3	65 kA
3.5	65 kA
4	65 kA
5	45 kA
6	45 kA
8	45 kA
10	45 kA
12	45 kA
13	45 kA
15	45 kA
16	45 kA
20	45 kA
25	45 kA
32	45 kA
40	25 kA
50	25 kA
63	25 kA

FAZ and NZM7

I_n [A]	FAZ- I_n /1(2,3,4)/B(C) + NZM7-40(...100) $U_e = 230/400 V$
0.16	25 kA
0.25	25 kA
0.5	25 kA
0.75	25 kA
1	25 kA
1.5	25 kA
2	25 kA
2.5	25 kA
3	25 kA
3.5	25 kA
4	25 kA
5	20 kA
6	20 kA
8	20 kA
10	20 kA
12	20 kA
13	20 kA
15	20 kA
16	20 kA
20	18 kA
25	18 kA
32	18 kA
40	18 kA
50	15 kA
63	15 kA

FAZ and NZMB1

$U_e = 230/400\text{ V}$: I_{cu} (FAZ) = 15 kA

$U_e = 230/400\text{ V}$: I_{cu} (NZMB1) = 25 kA

Back-up test acc. EN/IEC 60947-2, app. A: $U = 1.05U_e$, (O - t - CO)

(Settings NZMB1: I_r , I_{rm} at max. volumes)

I_n [A]	FAZ-$I_n/1(2,3,4)/B(C)$ + NZMB1 $U_e = 230/400\text{ V}$
0.16	25 kA
0.25	25 kA
0.5	25 kA
0.75	25 kA
1	25 kA
1.5	25 kA
2	25 kA
2.5	25 kA
3	25 kA
3.5	25 kA
4	25 kA
5	25 kA
6	25 kA
8	25 kA
10	25 kA
12	25 kA
13	25 kA
15	25 kA
16	25 kA
20	20 kA
25	20 kA
32	20 kA
40	20 kA
50	15 kA
63	15 kA

FAZ and NZMN1

$U_e = 230/400\text{ V}$: I_{cu} (FAZ) = 15 kA

$U_e = 230/400\text{ V}$: I_{cu} (NZMN1) = 25 kA

Back-up test acc. EN/IEC 60947-2, app. A: $U = 1.05U_e$, (O - t - CO)

(Settings NZM at max. values)

I_n [A]	FAZ-$I_n/1(2,3,4)/B(C)$ + NZMN1 $U_e = 230/400\text{ V}$
0.16	25 kA
0.25	25 kA
0.5	25 kA
0.75	25 kA
1	25 kA
1.5	25 kA
2	25 kA
2.5	25 kA
3	25 kA
3.5	25 kA
4	25 kA
5	25 kA
6	25 kA
8	25 kA
10	25 kA
12	25 kA
13	25 kA
15	25 kA
16	25 kA
20	20 kA
25	20 kA
32	20 kA
40	20 kA
50	15 kA
63	15 kA

FAZ and NZMB2

$U_e = 230/400\text{ V}$: I_{cu} (FAZ) = 15 kA
 $U_e = 230/400\text{ V}$: I_{cu} (NZMB2) = 25 kA
 $U_e = 133/230\text{ V}$: I_{cu} (FAZ) = 20 kA
 $U_e = 133/230\text{ V}$: I_{cu} (NZMB2) = 30 kA
 Back-up test acc. EN/IEC 60947-2, app. A: $U = 1.05U_e$, (O - t - CO)
 (Settings NZM at max. values)

I_n [A]	FAZ-$I_n/1(2,3,4)/B(C)$ + NZMB2	
	$U_e = 230/400\text{ V}$	$U_e = 133/230\text{ V}$
0.16	25 kA	30 kA
0.25	25 kA	30 kA
0.5	25 kA	30 kA
0.75	25 kA	30 kA
1	25 kA	30 kA
1.5	25 kA	30 kA
2	25 kA	30 kA
2.5	25 kA	30 kA
3	25 kA	30 kA
3.5	25 kA	30 kA
4	25 kA	30 kA
5	25 kA	25 kA
6	25 kA	25 kA
8	25 kA	25 kA
10	25 kA	25 kA
12	20 kA	25 kA
13	20 kA	25 kA
15	20 kA	25 kA
16	20 kA	25 kA
20	20 kA	25 kA
25	20 kA	25 kA
32	20 kA	25 kA
40	15 kA	20 kA
50	15 kA	20 kA
63	15 kA	20 kA

FAZ and NZMN2

$U_e = 230/400\text{ V}$: I_{cu} (FAZ) = 15 kA
 $U_e = 230/400\text{ V}$: I_{cu} (NZMN2) = 50 kA
 $U_e = 133/230\text{ V}$: I_{cu} (FAZ) = 20 kA
 $U_e = 133/230\text{ V}$: I_{cu} (NZMN2) = 85 kA
 Back-up test acc. EN/IEC 60947-2, app. A: $U = 1.05U_e$, (O - t - CO)
 (Settings NZM at max. values)

I_n [A]	FAZ-$I_n/1(2,3,4)/B(C)$ + NZMN2	
	$U_e = 230/400\text{ V}$	$U_e = 133/230\text{ V}$
0.16	50 kA	85 kA
0.25	50 kA	85 kA
0.5	50 kA	85 kA
0.75	50 kA	85 kA
1	50 kA	85 kA
1.5	50 kA	85 kA
2	50 kA	85 kA
2.5	50 kA	85 kA
3	50 kA	85 kA
3.5	50 kA	85 kA
4	50 kA	85 kA
5	50 kA	80 kA
6	50 kA	80 kA
8	50 kA	80 kA
10	50 kA	80 kA
12	30 kA	60 kA
13	30 kA	60 kA
15	30 kA	60 kA
16	30 kA	60 kA
20	30 kA	60 kA
25	30 kA	60 kA
32	30 kA	60 kA
40	20 kA	40 kA
50	20 kA	40 kA
63	20 kA	40 kA

FAZ and NZMH2

$U_e = 230/400\text{ V}$: I_{cu} (FAZ) = 15 kA
 $U_e = 230/400\text{ V}$: I_{cu} (NZMH2) = 150 kA
 $U_e = 133/230\text{ V}$: I_{cu} (FAZ) = 20 kA
 $U_e = 133/230\text{ V}$: I_{cu} (NZMH2) = 150 kA
 Back-up test acc. EN/IEC 60947-2, app. A: $U = 1.05U_e$, (O - t - CO)
 (Settings NZM at max. values)

I_n [A]	FAZ-$I_n/1(2,3,4)/B(C)$ + NZMH2	
	$U_e = 230/400\text{ V}$	$U_e = 133/230\text{ V}$
0.16	50 kA	85 kA
0.25	50 kA	85 kA
0.5	50 kA	85 kA
0.75	50 kA	85 kA
1	50 kA	85 kA
1.5	50 kA	85 kA
2	50 kA	85 kA
2.5	50 kA	85 kA
3	50 kA	85 kA
3.5	50 kA	85 kA
4	50 kA	85 kA
5	50 kA	80 kA
6	50 kA	80 kA
8	50 kA	80 kA
10	50 kA	80 kA
12	30 kA	60 kA
13	30 kA	60 kA
15	30 kA	60 kA
16	30 kA	60 kA
20	30 kA	60 kA
25	30 kA	60 kA
32	30 kA	60 kA
40	20 kA	40 kA
50	20 kA	40 kA
63	20 kA	40 kA

FAZ and NZML2

$U_e = 230/400\text{ V}$: I_{cu} (FAZ) = 15 kA
 $U_e = 230/400\text{ V}$: I_{cu} (NZML2) = 150 kA
 $U_e = 133/230\text{ V}$: I_{cu} (FAZ) = 20 kA
 $U_e = 133/230\text{ V}$: I_{cu} (NZML2) = 150 kA
 Back-up test acc. EN/IEC 60947-2, app. A: $U = 1.05U_e$, (O - t - CO)
 (Settings NZM at max. values)

I_n [A]	FAZ-$I_n/1(2,3,4)/B(C)$ + NZML2	
	$U_e = 230/400\text{ V}$	$U_e = 133/230\text{ V}$
0.16	50 kA	85 kA
0.25	50 kA	85 kA
0.5	50 kA	85 kA
0.75	50 kA	85 kA
1	50 kA	85 kA
1.5	50 kA	85 kA
2	50 kA	85 kA
2.5	50 kA	85 kA
3	50 kA	85 kA
3.5	50 kA	85 kA
4	50 kA	85 kA
5	50 kA	80 kA
6	50 kA	80 kA
8	50 kA	80 kA
10	50 kA	80 kA
12	30 kA	60 kA
13	30 kA	60 kA
15	30 kA	60 kA
16	30 kA	60 kA
20	30 kA	60 kA
25	30 kA	60 kA
32	30 kA	60 kA
40	20 kA	40 kA
50	20 kA	40 kA
63	20 kA	40 kA

FAZ and NH

$U_e = 230\text{ V}$: I_{cu} (FAZ) = 15 (10) kA (acc. to IEC/EN 60947)

$U_e = 500\text{ V}$: I_{cu} (NH00 125 A gL / gG) = 120kA

I_n [A]	FAZ-I_n/B,(C),(D)... + NH00 125 A gL/gG IT-system U = 230 V
0.5	50 kA
1	50 kA
2	50 kA
3	50 kA
4	50 kA
6	50 kA
10	50 kA
13	50 kA
16	50 kA
20	50 kA
25	50 kA
32	50 kA
40	50 kA
50	50 kA
63	50 kA

Overload Selectivity FAZ

FAZ-B(C)(D) to FAZ-B

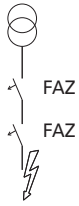

Upstream side FAZ, Characteristic B
Downstream side FAZ, Characteristic B, C, D

x ... Selectivity range (i.e. only the downstream switch drops in case $I < I_s$)

Upstream side	FAZ Characteristic B													
Type B rated current I_n [A]		2	3	4	6	10	13	16	20	25	32	40	50	63
Selectivity limiting current I_s [A]		7	10.5	14	21	35	45.5	56	70	87.5	112	140	175	220.5
Downstream side FAZ Characteristic B	2		x	x	x	x	x	x	x	x	x	x	x	x
	3			x	x	x	x	x	x	x	x	x	x	x
	4				x	x	x	x	x	x	x	x	x	x
	6					x	x	x	x	x	x	x	x	x
	10						x	x	x	x	x	x	x	x
	13							x	x	x	x	x	x	x
	16								x	x	x	x	x	x
	20									x	x	x	x	x
	25										x	x	x	x
	32											x	x	x
	40												x	x
	50													x
	63													

Upstream side	FAZ Characteristic B															
Type B rated current I_n [A]		2	3	4	6	10	13	16	20	25	32	40	50	63		
Selectivity limiting current I_s [A]		7	10.5	14	21	35	45.5	56	70	87.5	112	140	175	220.5		
Downstream side FAZ Characteristic C	0.5	x	x	x	x	x	x	x	x	x	x	x	x	x		
	1	x	x	x	x	x	x	x	x	x	x	x	x	x		
	2			x	x	x	x	x	x	x	x	x	x	x		
	3				x	x	x	x	x	x	x	x	x	x		
	4					x	x	x	x	x	x	x	x	x		
	6						x	x	x	x	x	x	x	x		
	8							x	x	x	x	x	x	x		
	10								x	x	x	x	x	x		
	13									x	x	x	x	x		
	16										x	x	x	x		
	20											x	x	x		
	25												x	x		
	32													x		
	40														x	
	50															x
63																x

Upstream side	FAZ Characteristic B															
Type B rated current I_n [A]		2	3	4	6	10	13	16	20	25	32	40	50	63		
Selectivity limiting current I_s [A]		7	10.5	14	21	35	45.5	56	70	87.5	112	140	175	220.5		
Downstream side FAZ Characteristic D	2					x	x	x	x	x	x	x	x	x		
	4							x	x	x	x	x	x	x		
	6								x	x	x	x	x	x		
	10										x	x	x	x		
	13											x	x	x		
	16												x	x		
	20													x		
	25														x	
	32															x
40																x

Overload Selectivity FAZ

FAZ-B(C)(D) to FAZ-C

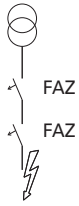

Upstream side FAZ, Characteristic C
Downstream side FAZ, Characteristic B, C, D

x ... Selectivity range (i.e. only the downstream switch drops in case $I < I_s$)

Upstream side →		FAZ Characteristic C																
Type B rated current I_n [A]		0.5	1	2	3	4	6	8	10	13	16	20	25	32	40	50	63	
Selectivity limiting current I_s [A]		2.85	5.7	11.4	17.1	22.8	34.2	45.6	57	74.1	91.2	114	142.5	182.4	228	285	359.1	
Downstream side FAZ Characteristic B	2				x	x	x	x	x	x	x	x	x	x	x	x	x	
	3					x	x	x	x	x	x	x	x	x	x	x	x	
	4						x	x	x	x	x	x	x	x	x	x	x	
	6							x	x	x	x	x	x	x	x	x	x	
	10									x	x	x	x	x	x	x	x	
	13										x	x	x	x	x	x	x	
	16											x	x	x	x	x	x	
	20												x	x	x	x	x	
	25													x	x	x	x	
	32														x	x	x	
	40															x	x	
	50																x	x
	63																	x

Upstream side →		FAZ Characteristic C															
Type B rated current I_n [A]		0.5	1	2	3	4	6	8	10	13	16	20	25	32	40	50	63
Selectivity limiting current I_s [A]		2.85	5.7	11.4	17.1	22.8	34.2	45.6	57	74.1	91.2	114	142.5	182.4	228	285	359.1
Downstream side FAZ Characteristic C	0.5		x	x	x	x	x	x	x	x	x	x	x	x	x	x	x
	1			x	x	x	x	x	x	x	x	x	x	x	x	x	x
	2				x	x	x	x	x	x	x	x	x	x	x	x	x
	3					x	x	x	x	x	x	x	x	x	x	x	x
	4						x	x	x	x	x	x	x	x	x	x	x
	6							x	x	x	x	x	x	x	x	x	x
	8								x	x	x	x	x	x	x	x	x
	10									x	x	x	x	x	x	x	x
	13										x	x	x	x	x	x	x
	16											x	x	x	x	x	x
	20												x	x	x	x	x
	25													x	x	x	x
	32														x	x	x
	40															x	x
	50																x
63																	x

Upstream side →		FAZ Characteristic C															
Type B rated current I_n [A]		0.5	1	2	3	4	6	8	10	13	16	20	25	32	40	50	63
Selectivity limiting current I_s [A]		2.85	5.7	11.4	17.1	22.8	34.2	45.6	57	74.1	91.2	114	142.5	182.4	228	285	359.1
Downstream side FAZ Characteristic D	2						x	x	x	x	x	x	x	x	x	x	x
	4							x	x	x	x	x	x	x	x	x	x
	6								x	x	x	x	x	x	x	x	x
	10										x	x	x	x	x	x	x
	13											x	x	x	x	x	x
	16												x	x	x	x	x
	20													x	x	x	x
	25														x	x	x
	32															x	x
40																x	x

Overload Selectivity FAZ

FAZ-B(C)(D) to FAZ-D

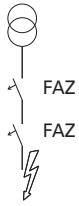

Upstream side FAZ, Characteristic D
Downstream side FAZ, Characteristic B, C, D

x ... Selectivity range (i.e. only the downstream switch drops in case $I < I_g$)

Upstream side	FAZ Characteristic D										
Type B rated current I_n [A]		2	4	6	10	13	16	20	25	32	40
Selectivity limiting current I_g [A]		21	42	63	105	136.5	168	210	262.5	336	420
Downstream side FAZ Characteristic B	2	x	x	x	x	x	x	x	x	x	x
	3		x	x	x	x	x	x	x	x	x
	4			x	x	x	x	x	x	x	x
	6				x	x	x	x	x	x	x
	10					x	x	x	x	x	x
	13						x	x	x	x	x
	16							x	x	x	x
	20								x	x	x
	25									x	x
	32										x
	40										
	50										
63											

Upstream side	FAZ Characteristic D											
Type B rated current I_n [A]		2	4	6	10	13	16	20	25	32	40	
Selectivity limiting current I_g [A]		21	42	63	105	136.5	168	210	262.5	336	420	
Downstream side FAZ Characteristic C	0.5	x	x	x	x	x	x	x	x	x	x	
	1	x	x	x	x	x	x	x	x	x	x	
	2		x	x	x	x	x	x	x	x	x	
	3			x	x	x	x	x	x	x	x	
	4				x	x	x	x	x	x	x	
	6					x	x	x	x	x	x	
	8						x	x	x	x	x	
	10							x	x	x	x	
	13								x	x	x	
	16									x	x	
	20										x	x
	25											x
	32											
	40											
50												
63												

Upstream side	FAZ Characteristic D										
Type B rated current I_n [A]		2	4	6	10	13	16	20	25	32	40
Selectivity limiting current I_g [A]		21	42	63	105	136.5	168	210	262.5	336	420
Downstream side FAZ Characteristic D	2	x	x	x	x	x	x	x	x	x	x
	4			x	x	x	x	x	x	x	x
	6				x	x	x	x	x	x	x
	10					x	x	x	x	x	x
	13						x	x	x	x	x
	16							x	x	x	x
	20								x	x	x
	25									x	x
	32										x
40											

Overload Selectivity FAZ

FAZ-B(C)(D) to AZ-C

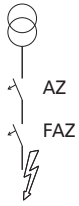

Upstream side AZ, Characteristic C
Downstream side FAZ, Characteristic B, C, D

x ... Selectivity range (i.e. only the downstream switch drops in case $I < I_g$)

Upstream side →		AZ Characteristic C										
Type B rated current I_n [A]		20	25	32	40	50	63	80	100	125		
Selectivity limiting current I_g [A]		130	163	208	260	325	410	520	650	813		
Downstream side FAZ Characteristic B	2	x	x	x	x	x	x	x	x	x	x	
	3	x	x	x	x	x	x	x	x	x	x	
	4	x	x	x	x	x	x	x	x	x	x	
	6	x	x	x	x	x	x	x	x	x	x	
	10	x	x	x	x	x	x	x	x	x	x	
	13	x	x	x	x	x	x	x	x	x	x	
	16	x	x	x	x	x	x	x	x	x	x	
	20		x	x	x	x	x	x	x	x	x	
	25			x	x	x	x	x	x	x	x	
	32				x	x	x	x	x	x	x	
	40					x	x	x	x	x	x	
	50						x	x	x	x	x	
63							x	x	x	x		

Upstream side →		AZ Characteristic C										
Type B rated current I_n [A]		20	25	32	40	50	63	80	100	125		
Selectivity limiting current I_g [A]		130	163	208	260	325	410	520	650	813		
Downstream side FAZ Characteristic C	0.5	x	x	x	x	x	x	x	x	x	x	
	1	x	x	x	x	x	x	x	x	x	x	
	2	x	x	x	x	x	x	x	x	x	x	
	3	x	x	x	x	x	x	x	x	x	x	
	4	x	x	x	x	x	x	x	x	x	x	
	6	x	x	x	x	x	x	x	x	x	x	
	8	x	x	x	x	x	x	x	x	x	x	
	10	x	x	x	x	x	x	x	x	x	x	
	13	x	x	x	x	x	x	x	x	x	x	
	16	x	x	x	x	x	x	x	x	x	x	
	20		x	x	x	x	x	x	x	x	x	
	25			x	x	x	x	x	x	x	x	
	32				x	x	x	x	x	x	x	
	40					x	x	x	x	x	x	
	50						x	x	x	x	x	
63							x	x	x	x		

Upstream side →		AZ Characteristic C										
Type B rated current I_n [A]		20	25	32	40	50	63	80	100	125		
Selectivity limiting current I_g [A]		130	163	208	260	325	410	520	650	813		
Downstream side FAZ Characteristic D	2	x	x	x	x	x	x	x	x	x	x	
	4	x	x	x	x	x	x	x	x	x	x	
	6	x	x	x	x	x	x	x	x	x	x	
	10	x	x	x	x	x	x	x	x	x	x	
	13		x	x	x	x	x	x	x	x	x	
	16			x	x	x	x	x	x	x	x	
	20				x	x	x	x	x	x	x	
	25					x	x	x	x	x	x	
	32						x	x	x	x	x	
	40							x	x	x	x	

Overload Selectivity FAZ

FAZ-B(C)(D) to AZ-D

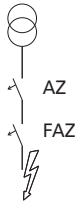

Upstream side AZ, Characteristic D
Downstream side FAZ, Characteristic B, C, D

x ... Selectivity range (i.e. only the downstream switch drops in case $I < I_g$)

Upstream side →		AZ Characteristic D							
Type B rated current I_n [A]		20	25	32	40	50	63	80	100
Selectivity limiting current I_g [A]		230	285	365	450	550	680	850	1020
Downstream side FAZ Characteristic B	2	x	x	x	x	x	x	x	x
	3	x	x	x	x	x	x	x	x
	4	x	x	x	x	x	x	x	x
	6	x	x	x	x	x	x	x	x
	10	x	x	x	x	x	x	x	x
	13	x	x	x	x	x	x	x	x
	16	x	x	x	x	x	x	x	x
	20		x	x	x	x	x	x	x
	25			x	x	x	x	x	x
	32				x	x	x	x	x
	40					x	x	x	x
	50						x	x	x
63							x	x	

Upstream side →		AZ Characteristic D							
Type B rated current I_n [A]		20	25	32	40	50	63	80	100
Selectivity limiting current I_g [A]		230	285	365	450	550	680	850	1020
Downstream side FAZ Characteristic C	0.5	x	x	x	x	x	x	x	x
	1	x	x	x	x	x	x	x	x
	2	x	x	x	x	x	x	x	x
	3	x	x	x	x	x	x	x	x
	4	x	x	x	x	x	x	x	x
	6	x	x	x	x	x	x	x	x
	8	x	x	x	x	x	x	x	x
	10	x	x	x	x	x	x	x	x
	13	x	x	x	x	x	x	x	x
	16	x	x	x	x	x	x	x	x
	20		x	x	x	x	x	x	x
	25			x	x	x	x	x	x
	32				x	x	x	x	x
	40					x	x	x	x
	50						x	x	x
63							x	x	

Upstream side →		AZ Characteristic D							
Type B rated current I_n [A]		20	25	32	40	50	63	80	100
Selectivity limiting current I_g [A]		230	285	365	450	550	680	850	1020
Downstream side FAZ Characteristic D	2	x	x	x	x	x	x	x	x
	4	x	x	x	x	x	x	x	x
	6	x	x	x	x	x	x	x	x
	10	x	x	x	x	x	x	x	x
	13	x	x	x	x	x	x	x	x
	16	x	x	x	x	x	x	x	x
	20		x	x	x	x	x	x	x
	25			x	x	x	x	x	x
	32				x	x	x	x	x
40					x	x	x	x	

Influence of the Line Frequency FAZ

On the Instantaneous Tripping Current I_{MA}

	Line Frequency f [Hz]						
	$16\frac{2}{3}$	50	60	100	200	300	400
$I_{MA}(f)/I_{MA}(50\text{Hz})$ [%]	91	100	101	106	115	134	141

Miniature Circuit Breakers FAZ-T

SG56012



FAZ-T

- High-quality miniature circuit breakers for industrial and commercial applications
- Contact position indicator red - green
- Accessories suitable for subsequent installation
- Rated currents up to 40 A
- Tripping characteristics B, C, D
- Rated breaking capacity up to 25 kA according to EN 60947-2

FAZ-T Miniature Circuit Breakers (MCBs)

Characteristic B

Rated current I_n (A)	Rated voltage IEC/EN 60898-1 (V)	Breaking capacity acc. to IEC/EN 60898-1 (kA)	Rated voltage IEC/EN 60947-2 (V)	Breaking capacity acc. to IEC/EN 60947-2 (kA)	Type Designation	Article No.	Units per package
----------------------------	---	---	---	---	---------------------	-------------	-------------------------

SG53212



1-pole

1	240/415	15	240	25	FAZT-B1/1	240770	12/120
2	240/415	15	240	25	FAZT-B2/1	240771	12/120
3	240/415	15	240	25	FAZT-B3/1	240772	12/120
4	240/415	15	240	25	FAZT-B4/1	240777	12/120
6	240/415	15	240	25	FAZT-B6/1	240782	12/120
10	240/415	15	240	25	FAZT-B10/1	240787	12/120
12	240/415	15	240	25	FAZT-B12/1	240792	12/120
13	240/415	15	240	25	FAZT-B13/1	240793	12/120
15	240/415	15	240	25	FAZT-B15/1	240794	12/120
16	240/415	15	240	25	FAZT-B16/1	240795	12/120
20	240/415	15	240	25	FAZT-B20/1	240796	12/120
25	240/415	15	240	25	FAZT-B25/1	240797	12/120
32	240/415	10	240	20	FAZT-B32/1	141907	12/120
40	240/415	10	240	20	FAZT-B40/1	141908	12/120

SG55412



1+N-pole

1	240	15	240	25	FAZT-B1/1N	240994	1/60
2	240	15	240	25	FAZT-B2/1N	240995	1/60
3	240	15	240	25	FAZT-B3/1N	240996	1/60
4	240	15	240	25	FAZT-B4/1N	240997	1/60
6	240	15	240	25	FAZT-B6/1N	240998	1/60
10	240	15	240	25	FAZT-B10/1N	240999	1/60
12	240	15	240	25	FAZT-B12/1N	241000	1/60
13	240	15	240	25	FAZT-B13/1N	241001	1/60
15	240	15	240	25	FAZT-B15/1N	241005	1/60
16	240	15	240	25	FAZT-B16/1N	241009	1/60
20	240	15	240	25	FAZT-B20/1N	241015	1/60
25	240	15	240	25	FAZT-B25/1N	241019	1/60
32	240	10	240	20	FAZT-B32/1N	142509	1/60
40	240	10	240	20	FAZT-B40/1N	142510	1/60

SG55212



2-pole

1	415	15	240/415	25	FAZT-B1/2	240820	1/60
2	415	15	240/415	25	FAZT-B2/2	240821	1/60
3	415	15	240/415	25	FAZT-B3/2	240822	1/60
4	415	15	240/415	25	FAZT-B4/2	240823	1/60
6	415	15	240/415	25	FAZT-B6/2	240824	1/60
10	415	15	240/415	25	FAZT-B10/2	240825	1/60
12	415	15	240/415	25	FAZT-B12/2	240826	1/60
13	415	15	240/415	25	FAZT-B13/2	240827	1/60
15	415	15	240/415	25	FAZT-B15/2	240828	1/60
16	415	15	240/415	25	FAZT-B16/2	240829	1/60
20	415	15	240/415	25	FAZT-B20/2	240830	1/60
25	415	15	240/415	25	FAZT-B25/2	240831	1/60
32	415	10	240/415	20	FAZT-B32/2	142485	1/60
40	415	10	240/415	20	FAZT-B40/2	142486	1/60

SG53512



3-pole

	Rated current I_n (A)	Rated voltage IEC/EN 60898-1 (V)	Breaking capacity acc. to IEC/EN 60898-1 (kA)	Rated voltage IEC/EN 60947-2 (V)	Breaking capacity acc. to IEC/EN 60947-2 (kA)	Type Designation	Article No.	Units per package
1	415	15	240/415	25		FAZT-B1/3	240874	1/40
2	415	15	240/415	25		FAZT-B2/3	240875	1/40
3	415	15	240/415	25		FAZT-B3/3	240876	1/40
4	415	15	240/415	25		FAZT-B4/3	240877	1/40
6	415	15	240/415	25		FAZT-B6/3	240878	1/40
10	415	15	240/415	25		FAZT-B10/3	240879	1/40
12	415	15	240/415	25		FAZT-B12/3	240880	1/40
13	415	15	240/415	25		FAZT-B13/3	240881	1/40
15	415	15	240/415	25		FAZT-B15/3	240882	1/40
16	415	15	240/415	25		FAZT-B16/3	240883	1/40
20	415	15	240/415	25		FAZT-B20/3	240884	1/40
25	415	15	240/415	25		FAZT-B25/3	240885	1/40
32	415	10	240/415	20		FAZT-B32/3	142493	1/40
40	415	10	240/415	20		FAZT-B40/3	142494	1/40

SG55912



3+N-pole

1	415	15	240/415	25		FAZT-B1/3N	241060	1/30
2	415	15	240/415	25		FAZT-B2/3N	241065	1/30
3	415	15	240/415	25		FAZT-B3/3N	241070	1/30
4	415	15	240/415	25		FAZT-B4/3N	241075	1/30
6	415	15	240/415	25		FAZT-B6/3N	241080	1/30
10	415	15	240/415	25		FAZT-B10/3N	241085	1/30
12	415	15	240/415	25		FAZT-B12/3N	241090	1/30
13	415	15	240/415	25		FAZT-B13/3N	241095	1/30
15	415	15	240/415	25		FAZT-B15/3N	241100	1/30
16	415	15	240/415	25		FAZT-B16/3N	241105	1/30
20	415	15	240/415	25		FAZT-B20/3N	241110	1/30
25	415	15	240/415	25		FAZT-B25/3N	241115	1/30
32	415	10	240/415	20		FAZT-B32/3N	142517	1/30
40	415	10	240/415	20		FAZT-B40/3N	142518	1/30

SG56012



4-pole

1	415	15	240/415	25		FAZT-B1/4	240922	1/30
2	415	15	240/415	25		FAZT-B2/4	240927	1/30
3	415	15	240/415	25		FAZT-B3/4	240930	1/30
4	415	15	240/415	25		FAZT-B4/4	240931	1/30
6	415	15	240/415	25		FAZT-B6/4	240932	1/30
10	415	15	240/415	25		FAZT-B10/4	240933	1/30
12	415	15	240/415	25		FAZT-B12/4	240934	1/30
13	415	15	240/415	25		FAZT-B13/4	240935	1/30
15	415	15	240/415	25		FAZT-B15/4	240936	1/30
16	415	15	240/415	25		FAZT-B16/4	240937	1/30
20	415	15	240/415	25		FAZT-B20/4	240938	1/30
25	415	15	240/415	25		FAZT-B25/4	240939	1/30
32	415	10	240/415	20		FAZT-B32/4	142501	1/30
40	415	10	240/415	20		FAZT-B40/4	142502	1/30

FAZ-T Miniature Circuit Breakers (MCBs)

Characteristic C

Rated current I_n (A)	Rated voltage IEC/EN 60898-1 (V)	Breaking capacity acc. to IEC/EN 60898-1 (kA)	Rated voltage IEC/EN 60947-2 (V)	Breaking capacity acc. to IEC/EN 60947-2 (kA)	Type Designation	Article No.	Units per package
----------------------------	---	---	---	---	---------------------	-------------	-------------------------

SG53212



1-pole

1	240/415	15	240	25	FAZT-C1/1	240798	12/120
2	240/415	15	240	25	FAZT-C2/1	240799	12/120
3	240/415	15	240	25	FAZT-C3/1	240800	12/120
4	240/415	15	240	25	FAZT-C4/1	240801	12/120
6	240/415	15	240	25	FAZT-C6/1	240802	12/120
10	240/415	15	240	25	FAZT-C10/1	240803	12/120
12	240/415	15	240	25	FAZT-C12/1	240804	12/120
13	240/415	15	240	25	FAZT-C13/1	240805	12/120
15	240/415	15	240	25	FAZT-C15/1	240806	12/120
16	240/415	15	240	25	FAZT-C16/1	240807	12/120
20	240/415	15	240	25	FAZT-C20/1	240808	12/120
25	240/415	15	240	25	FAZT-C25/1	240809	12/120
32	240/415	10	240	20	FAZT-C32/1	141909	12/120
40	240/415	10	240	20	FAZT-C40/1	142480	12/120

SG55412



1+N-pole

1	240	15	240	25	FAZT-C1/1N	241022	1/60
2	240	15	240	25	FAZT-C2/1N	241023	1/60
3	240	15	240	25	FAZT-C3/1N	241024	1/60
4	240	15	240	25	FAZT-C4/1N	241025	1/60
6	240	15	240	25	FAZT-C6/1N	241026	1/60
10	240	15	240	25	FAZT-C10/1N	241027	1/60
12	240	15	240	25	FAZT-C12/1N	241028	1/60
13	240	15	240	25	FAZT-C13/1N	241029	1/60
15	240	15	240	25	FAZT-C15/1N	241030	1/60
16	240	15	240	25	FAZT-C16/1N	241034	1/60
20	240	15	240	25	FAZT-C20/1N	241038	1/60
25	240	15	240	25	FAZT-C25/1N	241044	1/60
32	240	10	240	20	FAZT-C32/1N	142511	1/60
40	240	10	240	20	FAZT-C40/1N	142512	1/60

SG55212



2-pole

1	415	15	240/415	25	FAZT-C1/2	240832	1/60
2	415	15	240/415	25	FAZT-C2/2	240833	1/60
3	415	15	240/415	25	FAZT-C3/2	240838	1/60
4	415	15	240/415	25	FAZT-C4/2	240843	1/60
6	415	15	240/415	25	FAZT-C6/2	240850	1/60
10	415	15	240/415	25	FAZT-C10/2	240855	1/60
12	415	15	240/415	25	FAZT-C12/2	240858	1/60
13	415	15	240/415	25	FAZT-C13/2	240859	1/60
15	415	15	240/415	25	FAZT-C15/2	240860	1/60
16	415	15	240/415	25	FAZT-C16/2	240861	1/60
20	415	15	240/415	25	FAZT-C20/2	240862	1/60
25	415	15	240/415	25	FAZT-C25/2	240863	1/60
32	415	10	240/415	20	FAZT-C32/2	142487	1/60
40	415	10	240/415	20	FAZT-C40/2	142488	1/60

SG53512



3-pole

	Rated current I_n (A)	Rated voltage IEC/EN 60898-1 (V)	Breaking capacity acc. to IEC/EN 60898-1 (kA)	Rated voltage IEC/EN 60947-2 (V)	Breaking capacity acc. to IEC/EN 60947-2 (kA)	Type Designation	Article No.	Units per package
1	415	15	240/415	25		FAZT-C1/3	240886	1/40
2	415	15	240/415	25		FAZT-C2/3	240887	1/40
3	415	15	240/415	25		FAZT-C3/3	240888	1/40
4	415	15	240/415	25		FAZT-C4/3	240889	1/40
6	415	15	240/415	25		FAZT-C6/3	240890	1/40
10	415	15	240/415	25		FAZT-C10/3	240891	1/40
12	415	15	240/415	25		FAZT-C12/3	240892	1/40
13	415	15	240/415	25		FAZT-C13/3	240893	1/40
15	415	15	240/415	25		FAZT-C15/3	240894	1/40
16	415	15	240/415	25		FAZT-C16/3	240895	1/40
20	415	15	240/415	25		FAZT-C20/3	240896	1/40
25	415	15	240/415	25		FAZT-C25/3	240897	1/40
32	415	10	240/415	20		FAZT-C32/3	142495	1/40
40	415	10	240/415	20		FAZT-C40/3	142496	1/40

SG55912



3+N-pole

1	415	15	240/415	25		FAZT-C1/3N	241120	1/30
2	415	15	240/415	25		FAZT-C2/3N	241125	1/30
3	415	15	240/415	25		FAZT-C3/3N	241130	1/30
4	415	15	240/415	25		FAZT-C4/3N	241135	1/30
6	415	15	240/415	25		FAZT-C6/3N	241140	1/30
10	415	15	240/415	25		FAZT-C10/3N	241145	1/30
12	415	15	240/415	25		FAZT-C12/3N	241150	1/30
13	415	15	240/415	25		FAZT-C13/3N	241155	1/30
15	415	15	240/415	25		FAZT-C15/3N	241160	1/30
16	415	15	240/415	25		FAZT-C16/3N	241165	1/30
20	415	15	240/415	25		FAZT-C20/3N	241170	1/30
25	415	15	240/415	25		FAZT-C25/3N	241175	1/30
32	415	10	240/415	20		FAZT-C32/3N	142519	1/30
40	415	10	240/415	20		FAZT-C40/3N	142520	1/30

SG56012



4-pole

1	415	15	240/415	25		FAZT-C1/4	240940	1/30
2	415	15	240/415	25		FAZT-C2/4	240941	1/30
3	415	15	240/415	25		FAZT-C3/4	240945	1/30
4	415	15	240/415	25		FAZT-C4/4	240949	1/30
6	415	15	240/415	25		FAZT-C6/4	240955	1/30
10	415	15	240/415	25		FAZT-C10/4	240959	1/30
12	415	15	240/415	25		FAZT-C12/4	240962	1/30
13	415	15	240/415	25		FAZT-C13/4	240963	1/30
15	415	15	240/415	25		FAZT-C15/4	240964	1/30
16	415	15	240/415	25		FAZT-C16/4	240965	1/30
20	415	15	240/415	25		FAZT-C20/4	240966	1/30
25	415	15	240/415	25		FAZT-C25/4	240967	1/30
32	415	10	240/415	20		FAZT-C32/4	142503	1/30
40	415	10	240/415	20		FAZT-C40/4	142504	1/30

FAZ-T Miniature Circuit Breakers (MCBs)

Characteristic D

Rated current I_n (A)	Rated voltage IEC/EN 60898-1 (V)	Breaking capacity acc. to IEC/EN 60898-1 (kA)	Rated voltage IEC/EN 60947-2 (V)	Breaking capacity acc. to IEC/EN 60947-2 (kA)	Type Designation	Article No.	Units per package
----------------------------	---	---	---	---	---------------------	-------------	-------------------------

SG53212



1-pole

1	240/415	15	240	25	FAZT-D1/1	240810	12/120
2	240/415	15	240	25	FAZT-D2/1	240811	12/120
3	240/415	15	240	25	FAZT-D3/1	240812	12/120
4	240/415	15	240	25	FAZT-D4/1	240813	12/120
6	240/415	15	240	25	FAZT-D6/1	240814	12/120
10	240/415	15	240	25	FAZT-D10/1	240815	12/120
12	240/415	15	240	25	FAZT-D12/1	240816	12/120
13	240/415	15	240	25	FAZT-D13/1	240817	12/120
15	240/415	15	240	20	FAZT-D15/1	240818	12/120
16	240/415	15	240	20	FAZT-D16/1	240819	12/120
20	240/415	10	240	20	FAZT-D20/1	142481	12/120
25	240/415	10	240	15	FAZT-D25/1	142482	12/120
32	240/415	10	240	15	FAZT-D32/1	142483	12/120
40	240/415	10	240	15	FAZT-D40/1	142484	12/120

SG55412



1+N-pole

1	240	15	240	25	FAZT-D1/1N	241048	1/60
2	240	15	240	25	FAZT-D2/1N	241051	1/60
3	240	15	240	25	FAZT-D3/1N	241052	1/60
4	240	15	240	25	FAZT-D4/1N	241053	1/60
6	240	15	240	25	FAZT-D6/1N	241054	1/60
10	240	15	240	25	FAZT-D10/1N	241055	1/60
12	240	15	240	25	FAZT-D12/1N	241056	1/60
13	240	15	240	25	FAZT-D13/1N	241057	1/60
15	240	15	240	20	FAZT-D15/1N	241058	1/60
16	240	15	240	20	FAZT-D16/1N	241059	1/60
20	240	10	240	20	FAZT-D20/1N	142513	1/60
25	240	10	240	15	FAZT-D25/1N	142514	1/60
32	240	10	240	15	FAZT-D32/1N	142515	1/60
40	240	10	240	15	FAZT-D40/1N	142516	1/60

SG55212



2-pole

1	415	15	240/415	25	FAZT-D1/2	240864	1/60
2	415	15	240/415	25	FAZT-D2/2	240865	1/60
3	415	15	240/415	25	FAZT-D3/2	240866	1/60
4	415	15	240/415	25	FAZT-D4/2	240867	1/60
6	415	15	240/415	25	FAZT-D6/2	240868	1/60
10	415	15	240/415	25	FAZT-D10/2	240869	1/60
12	415	15	240/415	25	FAZT-D12/2	240870	1/60
13	415	15	240/415	25	FAZT-D13/2	240871	1/60
15	415	15	240/415	20	FAZT-D15/2	240872	1/60
16	415	15	240/415	20	FAZT-D16/2	240873	1/60
20	415	10	240/415	20	FAZT-D20/2	142489	1/60
25	415	10	240/415	15	FAZT-D25/2	142490	1/60
32	415	10	240/415	15	FAZT-D32/2	142491	1/60
40	415	10	240/415	15	FAZT-D40/2	142492	1/60

SG53512



3-pole

	Rated current I_n (A)	Rated voltage IEC/EN 60898-1 (V)	Breaking capacity acc. to IEC/EN 60898-1 (kA)	Rated voltage IEC/EN 60947-2 (V)	Breaking capacity acc. to IEC/EN 60947-2 (kA)	Type Designation	Article No.	Units per package
1	415	15	240/415	25		FAZT-D1/3	240898	1/40
2	415	15	240/415	25		FAZT-D2/3	240899	1/40
3	415	15	240/415	25		FAZT-D3/3	240900	1/40
4	415	15	240/415	25		FAZT-D4/3	240901	1/40
6	415	15	240/415	25		FAZT-D6/3	240902	1/40
10	415	15	240/415	25		FAZT-D10/3	240903	1/40
12	415	15	240/415	25		FAZT-D12/3	240904	1/40
13	415	15	240/415	25		FAZT-D13/3	240905	1/40
15	415	15	240/415	25		FAZT-D15/3	240910	1/40
16	415	15	240/415	25		FAZT-D16/3	240915	1/40
20	415	10	240/415	20		FAZT-D20/3	142497	1/40
25	415	10	240/415	15		FAZT-D25/3	142498	1/40
32	415	10	240/415	15		FAZT-D32/3	142499	1/40
40	415	10	240/415	15		FAZT-D40/3	142500	1/40

SG55912



3+N-pole

1	415	15	240/415	25		FAZT-D1/3N	241180	1/30
2	415	15	240/415	25		FAZT-D2/3N	241181	1/30
3	415	15	240/415	25		FAZT-D3/3N	241182	1/30
4	415	15	240/415	25		FAZT-D4/3N	241183	1/30
6	415	15	240/415	25		FAZT-D6/3N	241184	1/30
10	415	15	240/415	25		FAZT-D10/3N	241185	1/30
12	415	15	240/415	25		FAZT-D12/3N	241186	1/30
13	415	15	240/415	25		FAZT-D13/3N	241187	1/30
15	415	15	240/415	25		FAZT-D15/3N	241188	1/30
16	415	15	240/415	25		FAZT-D16/3N	241189	1/30
20	415	10	240/415	20		FAZT-D20/3N	142521	1/30
25	415	10	240/415	15		FAZT-D25/3N	142522	1/30
32	415	10	240/415	15		FAZT-D32/3N	142523	1/30
40	415	10	240/415	15		FAZT-D40/3N	142524	1/30

SG56012



4-pole

1	415	15	240/415	25		FAZT-D1/4	240968	1/30
2	415	15	240/415	25		FAZT-D2/4	240969	1/30
3	415	15	240/415	25		FAZT-D3/4	240970	1/30
4	415	15	240/415	25		FAZT-D4/4	240971	1/30
6	415	15	240/415	25		FAZT-D6/4	240975	1/30
10	415	15	240/415	25		FAZT-D10/4	240979	1/30
12	415	15	240/415	25		FAZT-D12/4	240985	1/30
13	415	15	240/415	25		FAZT-D13/4	240989	1/30
15	415	15	240/415	25		FAZT-D15/4	240992	1/30
16	415	15	240/415	25		FAZT-D16/4	240993	1/30
20	415	10	240/415	20		FAZT-D20/4	142505	1/30
25	415	10	240/415	15		FAZT-D25/4	142506	1/30
32	415	10	240/415	15		FAZT-D32/4	142507	1/30
40	415	10	240/415	15		FAZT-D40/4	142508	1/30

Specifications FAZ-T

Technical data

	FAZ-T
Productstandard	IEC/EN 60947-2 IEC/EN 60898-1
Number of poles	1, 1p+N, 2, 3, 3p+N, 4

Mechanical specifications

Device width	17.7 mm (1p), 27 mm (1p+N), 36 mm (2p), 54 mm (3p), 72mm (3p+N), 72 mm (4p)
Frame size	45 mm
Socket size	80 mm
Device depth	60 mm
Terminals	lift terminal
Terminal capacity rigid solid/stranded wire	1-25 mm ²
Terminal screw	M5 (with slotted screw acc. to EN ISO 4757-Z2, PZ2)
Terminal torque	max. 2.4 Nm
Snap on fixing	tristable (on DIN rail acc. to EN 50022)
Finger proof	acc. to VBG4, ÖVE EN-6
Degree of Protection (DIN VDE 0470)	
Surface mounted	IP 20
Built-in behind panel	IP 40
Contact position indicator	red / green

Electrical specifications

Rated voltage	U_n	240/415Vac 60Vdc per pole
Rated current	I_n	Type B, C, D: 1, 2, 3, 4, 6, 10, 12, 13, 15, 16, 20, 25, 32, 40 A
Rated insulation voltage	U_i	440 V
Rated impulse withstand voltage	U_{imp}	4 kV (1.2/50) μ sec

Tripping characteristic

Conventional non-tripping current	I_{nt}	$= 1.13 I_n$
Conventional tripping current	I_t	$= 1.45 I_n$
Reference temperature		30 °C
Temperature factor		0.4% /K
Instantaneous tripping current	I_{mt}	type B: $3 I_n < I_{mt} = 5 I_n \cdot t (I_{mt}) < 0.1$ sec type C: $5 I_n < I_{mt} = 10 I_n \cdot t (I_{mt}) < 0.1$ sec type D: $10 I_n < I_{mt} = 20 I_n \cdot t (I_{mt}) < 0.1$ sec

Rated ultimate short-circuit braking capacity I_{cu} (IEC/EN 60947-2)		
type B	1-25 A: 25 kA, 32-40 A: 20 kA	
type C	1-25 A: 25 kA, 32-40 A: 20 kA	
type D	1p/1p+N/2p - 1-13 A: 25 kA, 15-20 A: 20 kA, 25-40 A: 15 kA 3p/3p+N/4p - 1-16 A: 25 kA, 20 A: 20 kA, 25-40 A: 15 kA	

Rated service short-circuit braking capacity I_{cs} (IEC/EN 60947-2)		
for $I_{cu} = 25$ kA $\rightarrow I_{cs} = 12.5$ kA		
for $I_{cu} = 20$ kA $\rightarrow I_{cs} = 10$ kA		
for $I_{cu} = 15$ kA $\rightarrow I_{cs} = 7.5$ kA		

Rated short-circuit braking capacity I_{cn} (IEC/EN 60898-1)		
type B	1-25 A: 15 kA, 32-40 A: 10 kA	
type C	1-25 A: 15 kA, 32-40 A: 10 kA	
type D	1-16 A: 15 kA, 20-40 A: 10 kA	

Selectivity class	3 (acc. to EN 60898)
Number of electrical operations	> 4000 (IEC/EN 60898)
Number of mechanical operations	> 10000 (IEC/EN 60947)
Climatic conditions	acc. to IEC 68-2 (25..55°C / 90..95% RH)
Operating temperature range	-40°C to +75°C

Connection diagram

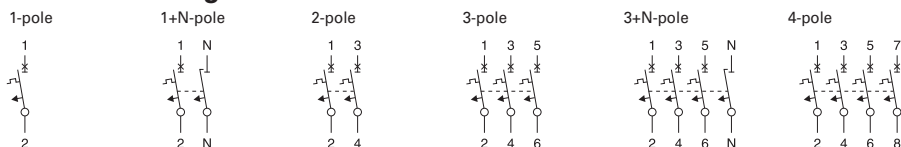

Dimensions (mm) FAZ-T

1-pole

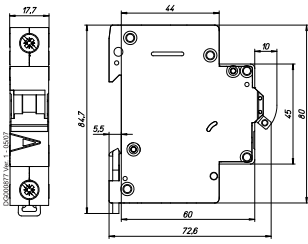

1+N-pole

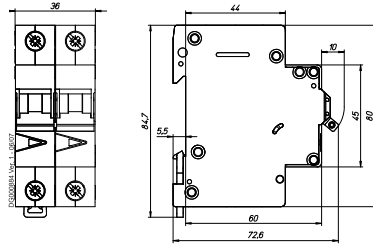

2-pole

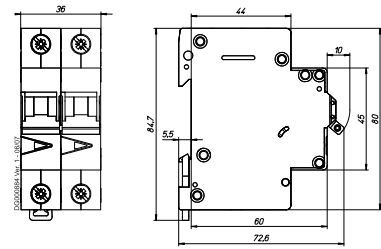

3-pole

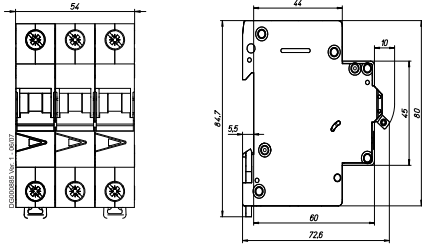

3+N-pole, 4-pole

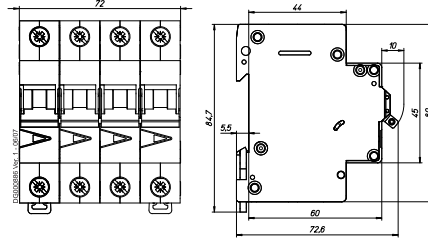

Tripping Characteristic FAZ-T

Characteristics B, C and D - EN60898

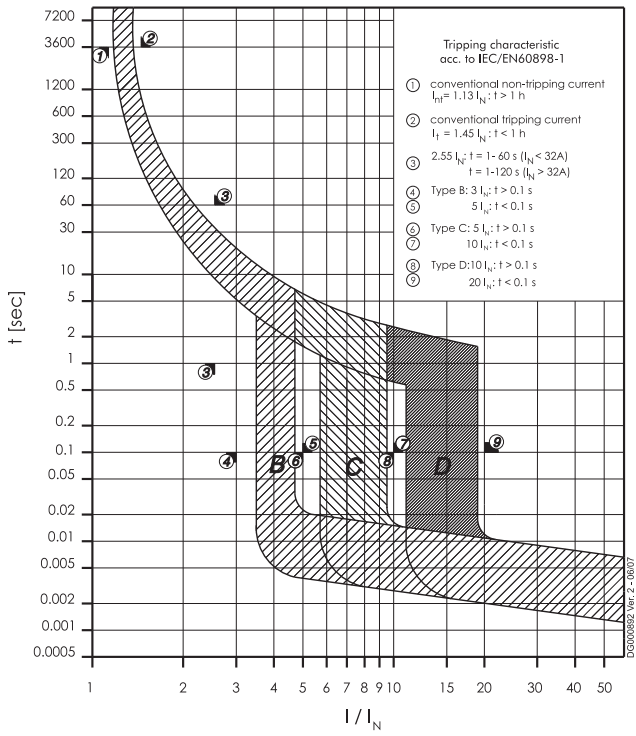

Power Loss at I_n FAZ-T

Type B

	1p	1pN	2p	3p	3pN*	4p
I_n [A]	P [W]	P [W]	P [W]	P [W]	P [W]	P [W]
1	1.6	1.7	3.1	4.7	4.8	6.3
2	1.4	1.5	2.8	4.1	4.3	5.5
3	2.5	2.7	5.0	7.6	7.8	10.1
4	1.4	1.6	2.9	4.4	4.5	5.8
6	1.8	2.0	3.6	5.5	5.6	7.3
10	1.9	2.1	3.9	5.9	6.1	7.8
12	2.8	3.2	5.9	8.7	9.0	11.5
13	2.5	2.9	5.3	7.8	8.1	10.3
15	2.1	2.4	4.4	6.5	6.7	8.6
16	2.2	2.6	4.7	6.9	7.2	9.1
20	3.2	3.6	6.6	9.8	10.1	13.0
25	3.0	3.5	6.4	9.4	9.7	12.4
32	3.7	4.4	8.1	12.1	12.5	15.8
40	3.4	4.1	7.5	11.2	11.5	14.6

*symmetrical load

Type C

	1p	1pN	2p	3p	3pN*	4p
I_n [A]	P [W]	P [W]	P [W]	P [W]	P [W]	P [W]
1	1.6	1.7	3.1	4.7	4.8	6.3
2	1.4	1.5	2.8	4.1	4.3	5.5
3	1.2	1.3	2.4	3.6	3.7	4.8
4	1.4	1.6	2.9	4.4	4.5	5.8
6	1.5	1.6	2.9	4.4	4.6	5.9
10	1.5	1.7	3.0	4.6	4.7	6.1
12	2.1	2.4	4.4	6.5	6.8	8.6
13	2.5	2.9	5.3	7.8	8.1	10.3
15	2.1	2.4	4.4	6.5	6.7	8.6
16	2.2	2.6	4.7	6.9	7.2	9.1
20	3.2	3.6	6.6	9.8	10.1	13.0
25	3.0	3.5	6.4	9.4	9.7	12.4
32	3.7	4.4	8.1	12.1	12.5	15.8
40	3.4	4.1	7.5	11.2	11.5	14.6

*symmetrical load

Type D

	1p	1pN	2p	3p	3pN*	4p
I_n [A]	P [W]	P [W]	P [W]	P [W]	P [W]	P [W]
1	0.8	0.9	1.6	2.4	2.5	3.2
2	1.0	1.1	2.0	3.0	3.1	4.0
3	1.2	1.3	2.4	3.6	3.7	4.8
4	1.4	1.6	2.9	4.4	4.5	5.8
6	1.5	1.6	2.9	4.4	4.6	5.9
10	1.5	1.7	3.0	4.6	4.7	6.1
12	1.7	2.0	3.6	5.3	5.4	7.0
13	1.9	2.2	4.0	5.9	6.1	7.8
15	2.1	2.4	4.4	6.5	6.7	8.6
16	2.2	2.6	4.7	6.9	7.2	9.1
20	2.0	2.2	4.1	6.1	6.2	8.1
25	2.5	2.9	5.2	7.7	7.9	10.2
32	3.4	4.0	7.4	11.1	11.4	14.5
40	3.2	3.8	7.0	10.4	10.7	13.6

*symmetrical load

Influence of Ambient Temperature FAZ-T

On Load Carrying Capacity (temperature derating)

I_N [A]	Ambient temperature T [°C]																
	-40	-30	-20	-10	0	10	20	30	35	40	45	50	55	60	65	70	75
1	1.3	1.2	1.2	1.2	1.1	1.1	1	1	0.99	0.97	0.95	0.93	0.9	0.89	0.87	0.85	0.83
2	2.6	2.5	2.4	2.3	2.2	2.2	2.1	2	2	1.9	1.9	1.9	1.8	1.8	1.7	1.7	1.7
3	3.8	3.7	3.6	3.5	3.4	3.3	3.1	3	3	2.9	2.8	2.8	2.7	2.7	2.6	2.5	2.5
4	5.1	5	4.8	4.7	4.5	4.3	4.2	4	3.9	3.9	3.8	3.7	3.6	3.5	3.5	3.4	3.3
6	7.7	7.5	7.2	7	6.7	6.5	6.3	6	5.9	5.8	5.7	5.6	5.4	5.3	5.2	5.1	5
10	13	12	12	12	11	11	10	10	9.9	9.7	9.5	9.3	9	8.9	8.7	8.5	8.3
12	15	15	14	14	13	13	13	12	12	12	11	11	11	11	10	10	10
13	17	16	16	15	15	14	14	13	13	13	12	12	12	12	11	11	11
15	19	19	18	17	17	16	16	15	15	15	14	14	14	13	13	13	12
16	20	20	19	19	18	17	17	16	16	15	15	15	14	14	14	14	13
20	26	25	24	23	22	22	21	20	20	19	19	19	18	18	17	17	17
25	32	31	30	29	28	27	26	25	25	24	24	23	23	22	22	21	21
32	41	40	38	37	36	35	33	32	32	31	30	30	29	28	28	27	26
40	51	50	48	47	45	43	42	40	39	39	38	37	36	35	35	34	33

Maximum Let-Through Energy FAZ-T

Type B

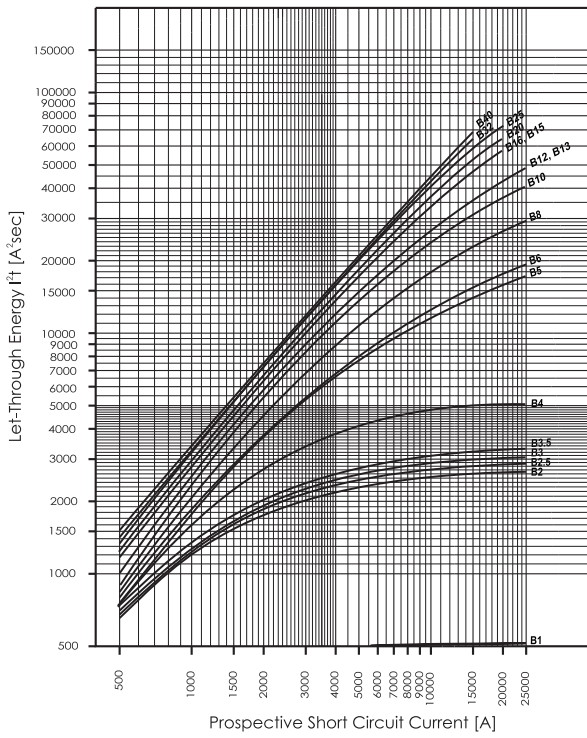

Type C

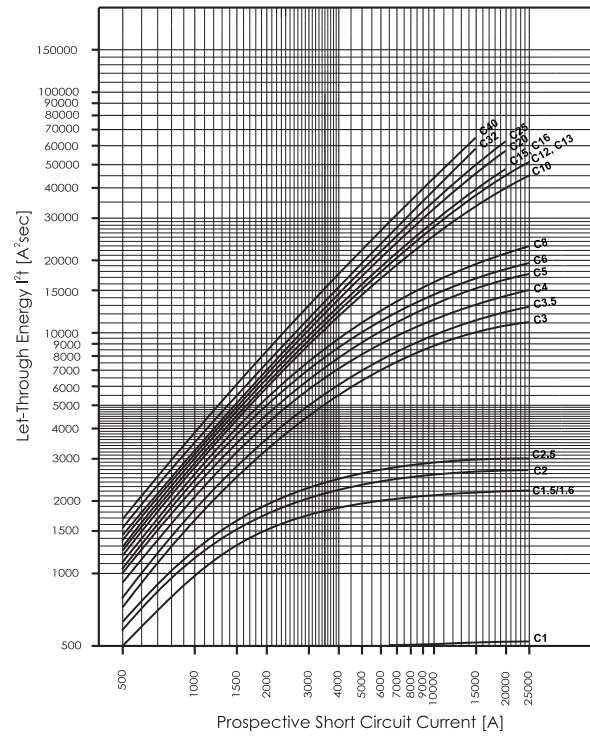

Type D

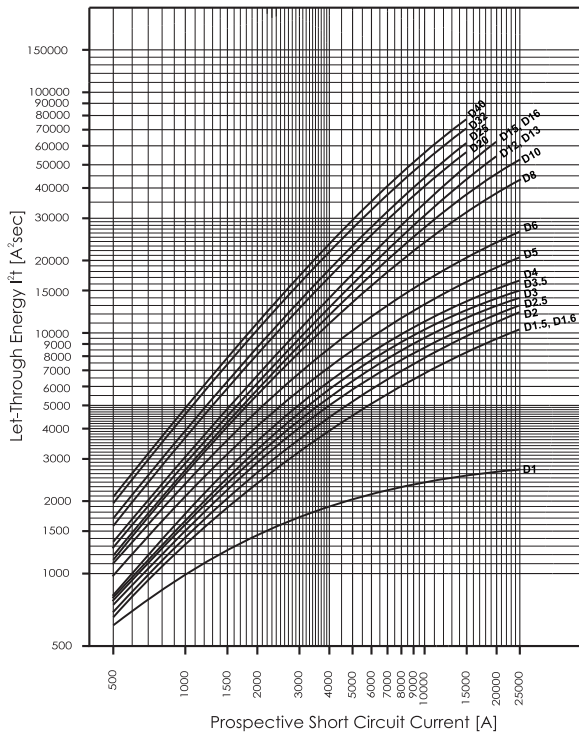

Maximum Let-Through Current FAZ-T

Type B

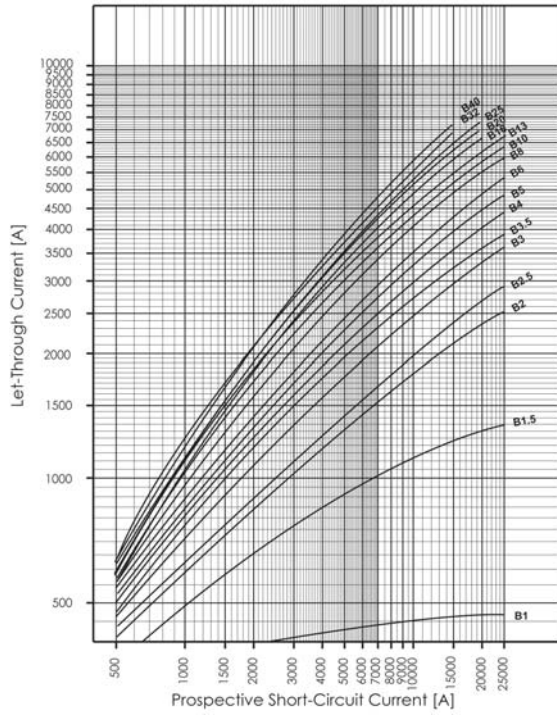

Type C

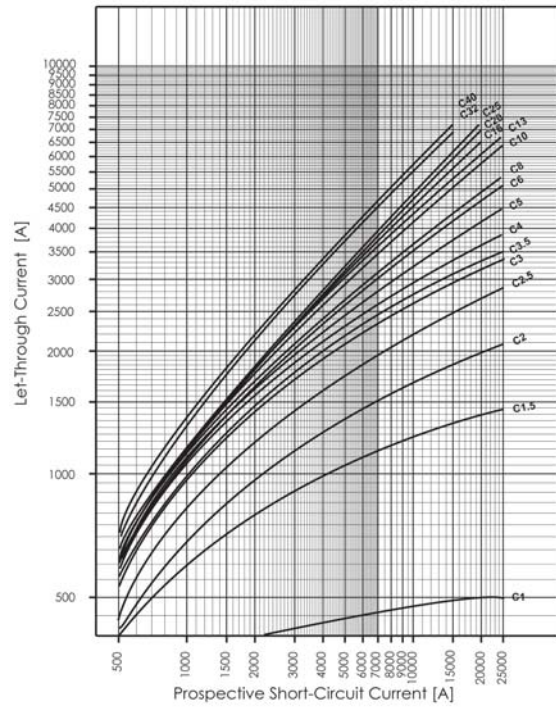

Type D

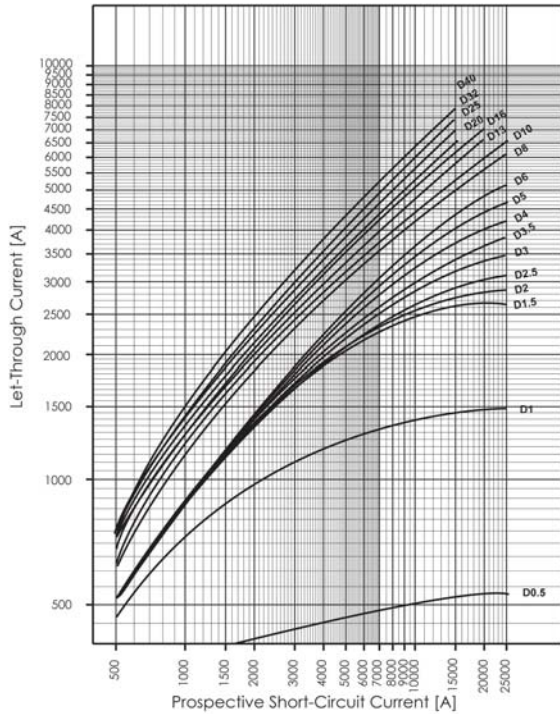

Influence of the Line Frequency FAZ-T

On the Instantaneous Tripping Current I_{MA}

	Line Frequency f [Hz]						
	$16\frac{2}{3}$	50	60	100	200	300	400
$I_{MA}(f)/I_{MA}(50\text{Hz})$ [%]	91	100	101	106	115	134	141

Load rating in case of circuit breakers arranged one next to the other FAZ-T

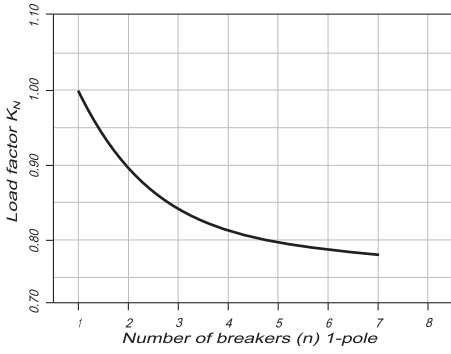

Miniature Circuit Breakers FAZ-DC

SG83312





FAZ-DC

- High-quality miniature circuit breakers for DC-applications
- Contact position indicator red - green
- Guide for secure terminal connection (not for FAZ-NA)
- 3-position DIN rail clip, permits removal from existing busbar system
- Comprehensive range of accessories suitable for subsequent installation
- Rated currents up to 50 A
- Tripping characteristic C
- Rated breaking capacity 10 kA according to IEC/EN 60947-2
- Up to 250 V DC pro pole

FAZ...-DC Miniature Circuit Breakers (MCBs)

Characteristic C

	Rated current I_n (A)	Rated voltage IEC/EN 60947-2 (V DC)	Breaking capacity acc. to IEC/EN 60947-2 (kA)	Type Designation	Article No.	Units per package
1-pole						
	2	220	10	FAZ-C2/1-DC	279122	12/120
	3	250	10	FAZ-C3/1-DC	279123	12/120
	4	250	10	FAZ-C4/1-DC	279124	12/120
	6	250	10	FAZ-C6/1-DC	279125	12/120
	10	250	10	FAZ-C10/1-DC	279126	12/120
	13	250	10	FAZ-C13/1-DC	279127	12/120
	16	250	10	FAZ-C16/1-DC	279128	12/120
	20	250	10	FAZ-C20/1-DC	279129	12/120
	25	250	10	FAZ-C25/1-DC	279130	12/120
	32	250	10	FAZ-C32/1-DC	279131	12/120
	40	250	10	FAZ-C40/1-DC	279132	12/120
	50	250	10	FAZ-C50/1-DC	279133	12/120
2-pole						
	2	440	10	FAZ-C2/2-DC	279134	1/60
	3	500	10	FAZ-C3/2-DC	279135	1/60
	4	500	10	FAZ-C4/2-DC	279136	1/60
	6	500	10	FAZ-C6/2-DC	279137	1/60
	10	500	10	FAZ-C10/2-DC	279138	1/60
	13	500	10	FAZ-C13/2-DC	279139	1/60
	16	500	10	FAZ-C16/2-DC	279140	1/60
	20	500	10	FAZ-C20/2-DC	279141	1/60
	25	500	10	FAZ-C25/2-DC	279142	1/60
	32	500	10	FAZ-C32/2-DC	279143	1/60
	40	500	10	FAZ-C40/2-DC	279144	1/60
	50	500	10	FAZ-C50/2-DC	279145	1/60

Specifications FAZ-DC

Technical data

	FAZ-DC *)
Productstandard	IEC/EN 60947-2
Number of poles	1, 2

Mechanical specifications

Device width	17.7 mm (1p), 36 mm (2p)
Frame size	45 mm
Socket size	80 mm
Device depth	60 mm
Terminals	lift terminal
Terminal capacity rigid solid/stranded wire	1-25 mm ²
Terminal screw	M5 (with slotted screw acc. to EN ISO 4757-Z2, PZ2)
Terminal torque	max. 2.4 Nm
Snap on fixing	tristable (on DIN rail acc. to EN 50022)
Finger proof	acc. to VBG4, ÖVE EN-6
Degree of Protection (DIN VDE 0470)	
Surface mounted	IP 20
Built-in behind panel	IP 40
Contact position indicator	red / green

Electrical specifications

Rated voltage DC	U_n	2 A type: 220V (per pole) 3-50 A types: 250V (per pole)
Rated current	I_n	Type C: 2, 3, 4, 6, 10, 13, 16, 20, 25, 32, 40, 50 A
Rated insulation voltage	U_i	440 V
Rated impulse withstand voltage	U_{imp}	4 kV (1.2/50)µsec

Tripping characteristic

Conventional non-tripping current		$I_{nt}=1.13 I_n$
Conventional tripping current		$I_t=1.45 I_n$
Reference temperature		30 °C
Temperature factor		0.4% /K
Instantaneous tripping current	I_{mt}	type C: $7 I_n < I_{mt} = 15 I_n$; t (I_{mt}) < 0.1 sec
Rated short-circuit braking capacity	I_{cu}	10 kA
Selectivity class		3
Number of electrical operations		> 4000
Number of mechanical operations		> 20000
Climatic conditions		acc. to IEC 68-2 (25..55°C / 90..95% RH)
Operating temperature range		-40°C to +75°C

*) not for PV string protection!

Connection diagram

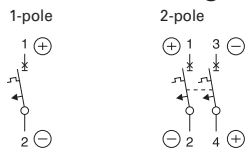

Dimensions (mm) FAZ-...-DC

1-pole

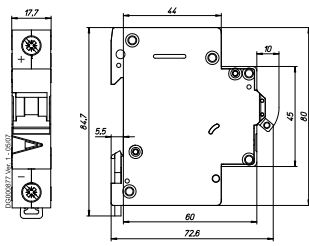

2-pole

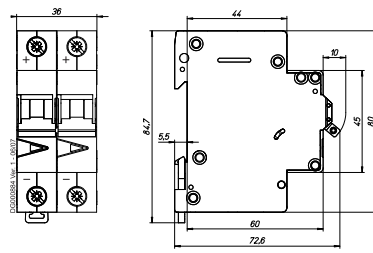

Connection examples FAZ-...-DC

Connection example at 250V=, 1-pole

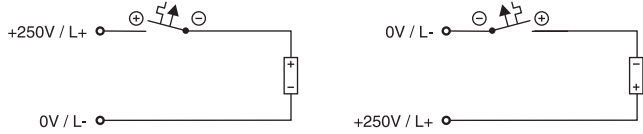

Connection example at 500V=, 2-pole

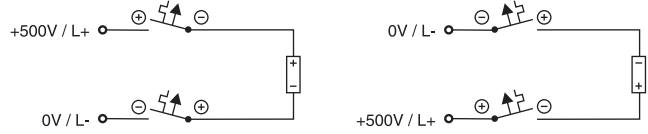

Tripping Characteristic FAZ-...-DC

Characteristics C - IEC/EN 60947-2

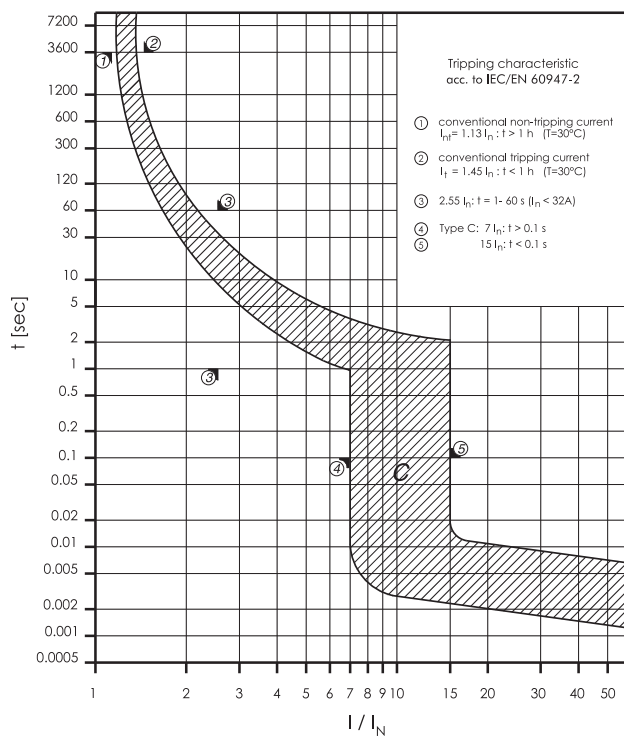

Maximum Let-Through Energy FAZ-...-DC

Type C

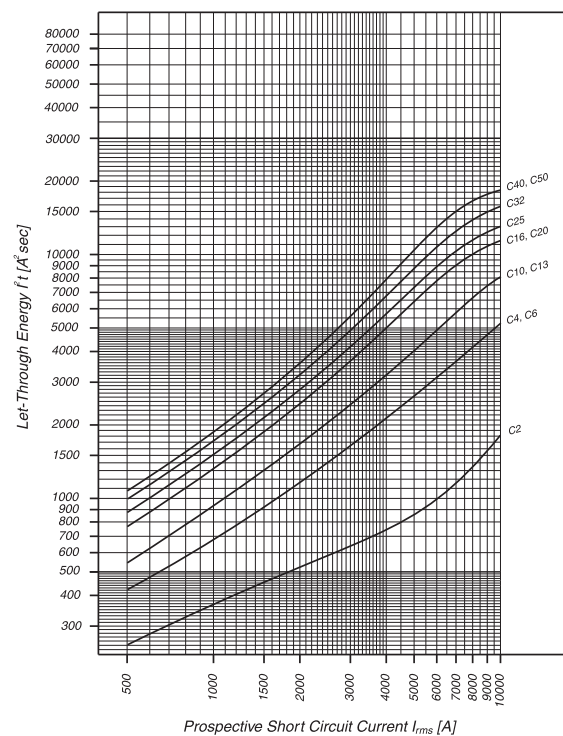

Miniature Circuit Breakers FAZ-NA, FAZ-RT

SG56912



FAZ-NA/-RT

- According to UL 489, CSA C22.2 No. 5 and also IEC 60947-2 standard
- For Applications, which are permitted for UL 1077 or CSA C22.2 No. 235
- Auxiliary switch and voltage trips suitable for subsequent installation
- Series with removable terminal screws (Type FAZ-...-RT), for use with ring cable lug
- Contact position indicator red - green
- Easy mounting at DIN-rail

FAZ-...-NA Miniature Circuit Breakers (MCBs)

Characteristic B

	Rated current I_n (A)	Rated voltage IEC/EN 60947-2 (V)	Breaking capacity acc. to IEC/EN 60947-2 (kA)	Rated voltage UL489 (V)	Breaking capacity acc. to UL489 (kA)	SWD	NFPA 79	Type Designation	Article No.	Units per package
1-pole										
1	240/415	15	277	10	SWD	AWG 18	FAZ-B1/1-NA	132414	12/120	
1.5	240/415	15	277	10	SWD	AWG 18	FAZ-B1,5/1-NA	132415	12/120	
2	240/415	15	277	10	SWD	AWG 18	FAZ-B2/1-NA	132416	12/120	
3	240/415	15	277	10	SWD	AWG 18	FAZ-B3/1-NA	132417	12/120	
4	240/415	15	277	10	SWD	AWG 18	FAZ-B4/1-NA	132418	12/120	
5	240/415	15	277	10	SWD	AWG 18	FAZ-B5/1-NA	132419	12/120	
6	240/415	15	277	10	SWD	AWG 18	FAZ-B6/1-NA	132680	12/120	
7	240/415	15	277	10	SWD	AWG 18	FAZ-B7/1-NA	132681	12/120	
8	240/415	15	277	10	SWD	AWG 16	FAZ-B8/1-NA	132682	12/120	
10	240/415	15	277	10	SWD	AWG 16	FAZ-B10/1-NA	132683	12/120	
13	240/415	15	277	10	SWD		FAZ-B13/1-NA	132684	12/120	
15	240/415	15	277	14	SWD		FAZ-B15/1-NA	132685	12/120	
16	240/415	15	277	14	SWD		FAZ-B16/1-NA	132686	12/120	
20	240/415	15	277	14	SWD		FAZ-B20/1-NA	132687	12/120	
25	240/415	15	277	14			FAZ-B25/1-NA	132688	12/120	
30	240/415	15	277	10			FAZ-B30/1-NA	132689	12/120	
32	240/415	15	277	10			FAZ-B32/1-NA	132690	12/120	
35	240/415	15	240	10			FAZ-B35/1-NA	132691	12/120	
40	240/415	15	240	10			FAZ-B40/1-NA	132692	12/120	
2-pole										
1	415	15	480Y/277	10	SWD	AWG 18	FAZ-B1/2-NA	132693	1/60	
1.5	415	15	480Y/277	10	SWD	AWG 18	FAZ-B1,5/2-NA	132694	1/60	
2	415	15	480Y/277	10	SWD	AWG 18	FAZ-B2/2-NA	132695	1/60	
3	415	15	480Y/277	10	SWD	AWG 18	FAZ-B3/2-NA	132696	1/60	
4	415	15	480Y/277	10	SWD	AWG 18	FAZ-B4/2-NA	132697	1/60	
5	415	15	480Y/277	10	SWD	AWG 18	FAZ-B5/2-NA	132698	1/60	
6	415	15	480Y/277	10	SWD	AWG 18	FAZ-B6/2-NA	132699	1/60	
7	415	15	480Y/277	10	SWD	AWG 18	FAZ-B7/2-NA	132700	1/60	
8	415	15	480Y/277	10	SWD	AWG 16	FAZ-B8/2-NA	132701	1/60	
10	415	15	480Y/277	10	SWD	AWG 16	FAZ-B10/2-NA	132702	1/60	
13	415	15	480Y/277	10	SWD		FAZ-B13/2-NA	132703	1/60	
15	415	15	480Y/277	14	SWD		FAZ-B15/2-NA	132704	1/60	
16	415	15	480Y/277	14	SWD		FAZ-B16/2-NA	132705	1/60	
20	415	15	480Y/277	14	SWD		FAZ-B20/2-NA	132706	1/60	
25	415	15	480Y/277	14			FAZ-B25/2-NA	132707	1/60	
30	415	15	480Y/277	10			FAZ-B30/2-NA	132708	1/60	
32	415	15	480Y/277	10			FAZ-B32/2-NA	132709	1/60	
35	415	15	240	10			FAZ-B35/2-NA	132710	1/60	
40	415	15	240	10			FAZ-B40/2-NA	132711	1/60	
3-pole										
1	415	15	480Y/277	10	SWD	AWG 18	FAZ-B1/3-NA	132712	1/40	
1.5	415	15	480Y/277	10	SWD	AWG 18	FAZ-B1,5/3-NA	132713	1/40	
2	415	15	480Y/277	10	SWD	AWG 18	FAZ-B2/3-NA	132714	1/40	
3	415	15	480Y/277	10	SWD	AWG 18	FAZ-B3/3-NA	132715	1/40	
4	415	15	480Y/277	10	SWD	AWG 18	FAZ-B4/3-NA	132716	1/40	
5	415	15	480Y/277	10	SWD	AWG 18	FAZ-B5/3-NA	132717	1/40	
6	415	15	480Y/277	10	SWD	AWG 18	FAZ-B6/3-NA	132718	1/40	
7	415	15	480Y/277	10	SWD	AWG 18	FAZ-B7/3-NA	132719	1/40	
8	415	15	480Y/277	10	SWD	AWG 16	FAZ-B8/3-NA	132720	1/40	
10	415	15	480Y/277	10	SWD	AWG 16	FAZ-B10/3-NA	132721	1/40	
13	415	15	480Y/277	10	SWD		FAZ-B13/3-NA	132722	1/40	
15	415	15	480Y/277	14	SWD		FAZ-B15/3-NA	132723	1/40	
16	415	15	480Y/277	14	SWD		FAZ-B16/3-NA	132724	1/40	
20	415	15	480Y/277	14	SWD		FAZ-B20/3-NA	132725	1/40	
25	415	15	480Y/277	14			FAZ-B25/3-NA	132726	1/40	
30	415	15	480Y/277	10			FAZ-B30/3-NA	132727	1/40	
32	415	15	480Y/277	10			FAZ-B32/3-NA	132728	1/40	
35	415	15	240	10			FAZ-B35/3-NA	132729	1/40	
40	415	15	240	10			FAZ-B40/3-NA	132730	1/40	



FAZ...-NA Miniature Circuit Breakers (MCBs)

Characteristic C

	Rated current I_n (A)	Rated voltage IEC/EN 60947-2 (V)	Breaking capacity acc. to IEC/EN 60947-2 (kA)	Rated voltage UL489 (V)	Breaking capacity acc. to UL489 (kA)	SWD	NFPA 79	Type Designation	Article No.	Units per package
1-pole										
0.5	240/415	15	277	10	10	SWD	AWG 18	FAZ-C0,5/1-NA	102077	12/120
1	240/415	15	277	10	10	SWD	AWG 18	FAZ-C1/1-NA	102078	12/120
1.5	240/415	15	277	10	10	SWD	AWG 18	FAZ-C1,5/1-NA	102079	12/120
2	240/415	15	277	10	10	SWD	AWG 18	FAZ-C2/1-NA	102080	12/120
3	240/415	15	277	10	10	SWD	AWG 18	FAZ-C3/1-NA	102081	12/120
4	240/415	15	277	10	10	SWD	AWG 18	FAZ-C4/1-NA	102082	12/120
5	240/415	15	277	10	10	SWD	AWG 18	FAZ-C5/1-NA	102083	12/120
6	240/415	15	277	10	10	SWD	AWG 18	FAZ-C6/1-NA	102084	12/120
7	240/415	15	277	10	10	SWD	AWG 18	FAZ-C7/1-NA	102085	12/120
8	240/415	15	277	10	10	SWD	AWG 16	FAZ-C8/1-NA	102086	12/120
10	240/415	15	277	10	10	SWD	AWG 16	FAZ-C10/1-NA	102087	12/120
13	240/415	15	277	10	10	SWD		FAZ-C13/1-NA	102088	12/120
15	240/415	15	277	14	14	SWD		FAZ-C15/1-NA	102089	12/120
16	240/415	15	277	14	14	SWD		FAZ-C16/1-NA	102090	12/120
20	240/415	15	277	14	14	SWD		FAZ-C20/1-NA	102091	12/120
25	240/415	15	277	14	14			FAZ-C25/1-NA	102092	12/120
30	240/415	15	277	10	10			FAZ-C30/1-NA	102093	12/120
32	240/415	15	277	10	10			FAZ-C32/1-NA	102094	12/120
35	240/415	15	240	10	10			FAZ-C35/1-NA	102095	12/120
40	240/415	15	240	10	10			FAZ-C40/1-NA	102096	12/120
2-pole										
0.5	415	15	480Y/277	10	10	SWD	AWG 18	FAZ-C0,5/2-NA	102157	1/60
1	415	15	480Y/277	10	10	SWD	AWG 18	FAZ-C1/2-NA	102158	1/60
1.5	415	15	480Y/277	10	10	SWD	AWG 18	FAZ-C1,5/2-NA	102159	1/60
2	415	15	480Y/277	10	10	SWD	AWG 18	FAZ-C2/2-NA	102160	1/60
3	415	15	480Y/277	10	10	SWD	AWG 18	FAZ-C3/2-NA	102161	1/60
4	415	15	480Y/277	10	10	SWD	AWG 18	FAZ-C4/2-NA	102162	1/60
5	415	15	480Y/277	10	10	SWD	AWG 18	FAZ-C5/2-NA	102163	1/60
6	415	15	480Y/277	10	10	SWD	AWG 18	FAZ-C6/2-NA	102164	1/60
7	415	15	480Y/277	10	10	SWD	AWG 18	FAZ-C7/2-NA	102165	1/60
8	415	15	480Y/277	10	10	SWD	AWG 16	FAZ-C8/2-NA	102166	1/60
10	415	15	480Y/277	10	10	SWD	AWG 16	FAZ-C10/2-NA	102167	1/60
13	415	15	480Y/277	10	10	SWD		FAZ-C13/2-NA	102168	1/60
15	415	15	480Y/277	14	14	SWD		FAZ-C15/2-NA	102169	1/60
16	415	15	480Y/277	14	14	SWD		FAZ-C16/2-NA	102170	1/60
20	415	15	480Y/277	14	14	SWD		FAZ-C20/2-NA	102171	1/60
25	415	15	480Y/277	14	14			FAZ-C25/2-NA	102172	1/60
30	415	15	480Y/277	10	10			FAZ-C30/2-NA	102173	1/60
32	415	15	480Y/277	10	10			FAZ-C32/2-NA	102174	1/60
35	415	15	240	10	10			FAZ-C35/2-NA	102175	1/60
40	415	15	240	10	10			FAZ-C40/2-NA	102176	1/60
3-pole										
0.5	415	15	480Y/277	10	10	SWD	AWG 18	FAZ-C0,5/3-NA	102237	1/40
1	415	15	480Y/277	10	10	SWD	AWG 18	FAZ-C1/3-NA	102238	1/40
1.5	415	15	480Y/277	10	10	SWD	AWG 18	FAZ-C1,5/3-NA	102239	1/40
2	415	15	480Y/277	10	10	SWD	AWG 18	FAZ-C2/3-NA	102240	1/40
3	415	15	480Y/277	10	10	SWD	AWG 18	FAZ-C3/3-NA	102241	1/40
4	415	15	480Y/277	10	10	SWD	AWG 18	FAZ-C4/3-NA	102242	1/40
5	415	15	480Y/277	10	10	SWD	AWG 18	FAZ-C5/3-NA	102243	1/40
6	415	15	480Y/277	10	10	SWD	AWG 18	FAZ-C6/3-NA	102244	1/40
7	415	15	480Y/277	10	10	SWD	AWG 18	FAZ-C7/3-NA	102245	1/40
8	415	15	480Y/277	10	10	SWD	AWG 16	FAZ-C8/3-NA	102246	1/40
10	415	15	480Y/277	10	10	SWD	AWG 16	FAZ-C10/3-NA	102247	1/40
13	415	15	480Y/277	10	10	SWD		FAZ-C13/3-NA	102248	1/40
15	415	15	480Y/277	14	14	SWD		FAZ-C15/3-NA	102249	1/40
16	415	15	480Y/277	14	14	SWD		FAZ-C16/3-NA	102250	1/40
20	415	15	480Y/277	14	14	SWD		FAZ-C20/3-NA	102251	1/40
25	415	15	480Y/277	14	14			FAZ-C25/3-NA	102252	1/40
30	415	15	480Y/277	10	10			FAZ-C30/3-NA	102253	1/40
32	415	15	480Y/277	10	10			FAZ-C32/3-NA	102254	1/40
35	415	15	240	10	10			FAZ-C35/3-NA	102255	1/40
40	415	15	240	10	10			FAZ-C40/3-NA	102256	1/40

SG53012



SG56812



SG56912



FAZ...-NA Miniature Circuit Breakers (MCBs)

Characteristic D

	Rated current I_n (A)	Rated voltage IEC/EN 60947-2 (V)	Breaking capacity acc. to IEC/EN 60947-2 (kA)	Rated voltage UL489 (V)	Breaking capacity acc. to UL489 (kA)	SWD	NFPA 79	Type Designation	Article No.	Units per package
1-pole										
	0.5	240/415	15	277	10	SWD	AWG 18	FAZ-D0,5/1-NA	102097	12/120
	1	240/415	15	277	10	SWD	AWG 18	FAZ-D1/1-NA	102098	12/120
	1.5	240/415	15	277	10	SWD	AWG 18	FAZ-D1,5/1-NA	102099	12/120
	2	240/415	15	277	10	SWD	AWG 18	FAZ-D2/1-NA	102100	12/120
	3	240/415	15	277	10	SWD	AWG 18	FAZ-D3/1-NA	102101	12/120
	4	240/415	15	277	10	SWD	AWG 18	FAZ-D4/1-NA	102102	12/120
	5	240/415	15	277	10	SWD	AWG 18	FAZ-D5/1-NA	102103	12/120
	6	240/415	15	277	10	SWD	AWG 18	FAZ-D6/1-NA	102104	12/120
	7	240/415	15	277	10	SWD	AWG 18	FAZ-D7/1-NA	102105	12/120
	8	240/415	15	277	10	SWD	AWG 16	FAZ-D8/1-NA	102106	12/120
	10	240/415	15	277	10	SWD	AWG 16	FAZ-D10/1-NA	102107	12/120
	13	240/415	15	277	14	SWD		FAZ-D13/1-NA	102108	12/120
	15	240/415	15	277	14	SWD		FAZ-D15/1-NA	102109	12/120
	16	240/415	15	277	14	SWD		FAZ-D16/1-NA	102110	12/120
	20	240/415	15	277	14	SWD		FAZ-D20/1-NA	102111	12/120
	25	240/415	15	277	10			FAZ-D25/1-NA	102112	12/120
	30	240/415	15	277	10			FAZ-D30/1-NA	102113	12/120
	32	240/415	15	277	10			FAZ-D32/1-NA	102114	12/120
	35	240/415	15	240	10			FAZ-D35/1-NA	102115	12/120
	40	240/415	15	240	10			FAZ-D40/1-NA	102116	12/120
2-pole										
	0.5	415	15	480Y/277	10	SWD	AWG 18	FAZ-D0,5/2-NA	102177	1/60
	1	415	15	480Y/277	10	SWD	AWG 18	FAZ-D1/2-NA	102178	1/60
	1.5	415	15	480Y/277	10	SWD	AWG 18	FAZ-D1,5/2-NA	102179	1/60
	2	415	15	480Y/277	10	SWD	AWG 18	FAZ-D2/2-NA	102180	1/60
	3	415	15	480Y/277	10	SWD	AWG 18	FAZ-D3/2-NA	102181	1/60
	4	415	15	480Y/277	10	SWD	AWG 18	FAZ-D4/2-NA	102182	1/60
	5	415	15	480Y/277	10	SWD	AWG 18	FAZ-D5/2-NA	102183	1/60
	6	415	15	480Y/277	10	SWD	AWG 18	FAZ-D6/2-NA	102184	1/60
	7	415	15	480Y/277	10	SWD	AWG 18	FAZ-D7/2-NA	102185	1/60
	8	415	15	480Y/277	10	SWD	AWG 16	FAZ-D8/2-NA	102186	1/60
	10	415	15	480Y/277	10	SWD	AWG 16	FAZ-D10/2-NA	102187	1/60
	13	415	15	480Y/277	14	SWD		FAZ-D13/2-NA	102188	1/60
	15	415	15	480Y/277	14	SWD		FAZ-D15/2-NA	102189	1/60
	16	415	15	480Y/277	14	SWD		FAZ-D16/2-NA	102190	1/60
	20	415	15	480Y/277	14	SWD		FAZ-D20/2-NA	102191	1/60
	25	415	15	480Y/277	10			FAZ-D25/2-NA	102192	1/60
	30	415	15	480Y/277	10			FAZ-D30/2-NA	102193	1/60
	32	415	15	480Y/277	10			FAZ-D32/2-NA	102194	1/60
	35	415	15	240	10			FAZ-D35/2-NA	102195	1/60
	40	415	15	240	10			FAZ-D40/2-NA	102196	1/60
3-pole										
	0.5	415	15	480Y/277	10	SWD	AWG 18	FAZ-D0,5/3-NA	102257	1/40
	1	415	15	480Y/277	10	SWD	AWG 18	FAZ-D1/3-NA	102258	1/40
	1.5	415	15	480Y/277	10	SWD	AWG 18	FAZ-D1,5/3-NA	102259	1/40
	2	415	15	480Y/277	10	SWD	AWG 18	FAZ-D2/3-NA	102260	1/40
	3	415	15	480Y/277	10	SWD	AWG 18	FAZ-D3/3-NA	102261	1/40
	4	415	15	480Y/277	10	SWD	AWG 18	FAZ-D4/3-NA	102262	1/40
	5	415	15	480Y/277	10	SWD	AWG 18	FAZ-D5/3-NA	102263	1/40
	6	415	15	480Y/277	10	SWD	AWG 18	FAZ-D6/3-NA	102264	1/40
	7	415	15	480Y/277	10	SWD	AWG 18	FAZ-D7/3-NA	102265	1/40
	8	415	15	480Y/277	10	SWD	AWG 16	FAZ-D8/3-NA	102266	1/40
	10	415	15	480Y/277	10	SWD	AWG 16	FAZ-D10/3-NA	102267	1/40
	13	415	15	480Y/277	14	SWD		FAZ-D13/3-NA	102268	1/40
	15	415	15	480Y/277	14	SWD		FAZ-D15/3-NA	102269	1/40
	16	415	15	480Y/277	14	SWD		FAZ-D16/3-NA	102270	1/40
	20	415	15	480Y/277	14	SWD		FAZ-D20/3-NA	102271	1/40
	25	415	15	480Y/277	10			FAZ-D25/3-NA	102272	1/40
	30	415	15	480Y/277	10			FAZ-D30/3-NA	102273	1/40
	32	415	15	480Y/277	10			FAZ-D32/3-NA	102274	1/40
	35	415	15	240	10			FAZ-D35/3-NA	102275	1/40
	40	415	15	240	10			FAZ-D40/3-NA	102276	1/40

SG53012



SG56812



SG56912



FAZ-...-RT Miniature Circuit Breakers (MCBs)

Characteristic B

	Rated current I_n (A)	Rated voltage IEC/EN 60947-2 (V)	Breaking capacity acc. to IEC/EN 60947-2 (kA)	Rated voltage UL489 (V)	Breaking capacity acc. to UL489 (kA)	SWD	NFPA 79	Type Designation	Article No.	Units per package
1-pole										
1	240/415	15	277	10	SWD	AWG 18	FAZ-B1/1-RT	132731	12/120	
1.5	240/415	15	277	10	SWD	AWG 18	FAZ-B1,5/1-RT	132732	12/120	
2	240/415	15	277	10	SWD	AWG 18	FAZ-B2/1-RT	132733	12/120	
3	240/415	15	277	10	SWD	AWG 18	FAZ-B3/1-RT	132734	12/120	
4	240/415	15	277	10	SWD	AWG 18	FAZ-B4/1-RT	132735	12/120	
5	240/415	15	277	10	SWD	AWG 18	FAZ-B5/1-RT	132736	12/120	
6	240/415	15	277	10	SWD	AWG 18	FAZ-B6/1-RT	132737	12/120	
7	240/415	15	277	10	SWD	AWG 18	FAZ-B7/1-RT	132738	12/120	
8	240/415	15	277	10	SWD	AWG 16	FAZ-B8/1-RT	132739	12/120	
10	240/415	15	277	10	SWD	AWG 16	FAZ-B10/1-RT	132740	12/120	
13	240/415	15	277	10	SWD		FAZ-B13/1-RT	132741	12/120	
15	240/415	15	277	14	SWD		FAZ-B15/1-RT	132742	12/120	
16	240/415	15	277	14	SWD		FAZ-B16/1-RT	132743	12/120	
20	240/415	15	277	14	SWD		FAZ-B20/1-RT	132744	12/120	
25	240/415	15	277	14			FAZ-B25/1-RT	132745	12/120	
30	240/415	15	277	10			FAZ-B30/1-RT	132746	12/120	
32	240/415	15	277	10			FAZ-B32/1-RT	132747	12/120	
35	240/415	15	240	10			FAZ-B35/1-RT	132748	12/120	
40	240/415	15	240	10			FAZ-B40/1-RT	132749	12/120	
2-pole										
1	415	15	480Y/277	10	SWD	AWG 18	FAZ-B1/2-RT	132750	1/60	
1.5	415	15	480Y/277	10	SWD	AWG 18	FAZ-B1,5/2-RT	132751	1/60	
2	415	15	480Y/277	10	SWD	AWG 18	FAZ-B2/2-RT	132752	1/60	
3	415	15	480Y/277	10	SWD	AWG 18	FAZ-B3/2-RT	132753	1/60	
4	415	15	480Y/277	10	SWD	AWG 18	FAZ-B4/2-RT	132754	1/60	
5	415	15	480Y/277	10	SWD	AWG 18	FAZ-B5/2-RT	132755	1/60	
6	415	15	480Y/277	10	SWD	AWG 18	FAZ-B6/2-RT	132756	1/60	
7	415	15	480Y/277	10	SWD	AWG 18	FAZ-B7/2-RT	132757	1/60	
8	415	15	480Y/277	10	SWD	AWG 16	FAZ-B8/2-RT	132758	1/60	
10	415	15	480Y/277	10	SWD	AWG 16	FAZ-B10/2-RT	132759	1/60	
13	415	15	480Y/277	10	SWD		FAZ-B13/2-RT	132760	1/60	
15	415	15	480Y/277	14	SWD		FAZ-B15/2-RT	132761	1/60	
16	415	15	480Y/277	14	SWD		FAZ-B16/2-RT	132762	1/60	
20	415	15	480Y/277	14	SWD		FAZ-B20/2-RT	132763	1/60	
25	415	15	480Y/277	14			FAZ-B25/2-RT	132764	1/60	
30	415	15	480Y/277	10			FAZ-B30/2-RT	132765	1/60	
32	415	15	480Y/277	10			FAZ-B32/2-RT	132766	1/60	
35	415	15	240	10			FAZ-B35/2-RT	132767	1/60	
40	415	15	240	10			FAZ-B40/2-RT	132768	1/60	
3-pole										
1	415	15	480Y/277	10	SWD	AWG 18	FAZ-B1/3-RT	132769	1/40	
1.5	415	15	480Y/277	10	SWD	AWG 18	FAZ-B1,5/3-RT	132770	1/40	
2	415	15	480Y/277	10	SWD	AWG 18	FAZ-B2/3-RT	132771	1/40	
3	415	15	480Y/277	10	SWD	AWG 18	FAZ-B3/3-RT	132772	1/40	
4	415	15	480Y/277	10	SWD	AWG 18	FAZ-B4/3-RT	132773	1/40	
5	415	15	480Y/277	10	SWD	AWG 18	FAZ-B5/3-RT	132774	1/40	
6	415	15	480Y/277	10	SWD	AWG 18	FAZ-B6/3-RT	132775	1/40	
7	415	15	480Y/277	10	SWD	AWG 18	FAZ-B7/3-RT	132776	1/40	
8	415	15	480Y/277	10	SWD	AWG 16	FAZ-B8/3-RT	132777	1/40	
10	415	15	480Y/277	10	SWD	AWG 16	FAZ-B10/3-RT	132778	1/40	
13	415	15	480Y/277	10	SWD		FAZ-B13/3-RT	132779	1/40	
15	415	15	480Y/277	14	SWD		FAZ-B15/3-RT	132780	1/40	
16	415	15	480Y/277	14	SWD		FAZ-B16/3-RT	132781	1/40	
20	415	15	480Y/277	14	SWD		FAZ-B20/3-RT	132782	1/40	
25	415	15	480Y/277	14			FAZ-B25/3-RT	132783	1/40	
30	415	15	480Y/277	10			FAZ-B30/3-RT	132784	1/40	
32	415	15	480Y/277	10			FAZ-B32/3-RT	132785	1/40	
35	415	15	240	10			FAZ-B35/3-RT	132786	1/40	
40	415	15	240	10			FAZ-B40/3-RT	132787	1/40	

SG56412



SG56712



SG57012



FAZ-...-RT Miniature Circuit Breakers (MCBs)

Characteristic C

	Rated current I_n (A)	Rated voltage IEC/EN 60947-2 (V)	Breaking capacity acc. to IEC/EN 60947-2 (kA)	Rated voltage UL489 (V)	Breaking capacity acc. to UL489 (kA)	SWD	NFPA 79	Type Designation	Article No.	Units per package
1-pole										
0.5	240/415	15	277	10	SWD	AWG 18	FAZ-C0,5/1-RT	102117	12/120	
1	240/415	15	277	10	SWD	AWG 18	FAZ-C1/1-RT	102118	12/120	
1.5	240/415	15	277	10	SWD	AWG 18	FAZ-C1,5/1-RT	102119	12/120	
2	240/415	15	277	10	SWD	AWG 18	FAZ-C2/1-RT	102120	12/120	
3	240/415	15	277	10	SWD	AWG 18	FAZ-C3/1-RT	102121	12/120	
4	240/415	15	277	10	SWD	AWG 18	FAZ-C4/1-RT	102122	12/120	
5	240/415	15	277	10	SWD	AWG 18	FAZ-C5/1-RT	102123	12/120	
6	240/415	15	277	10	SWD	AWG 18	FAZ-C6/1-RT	102124	12/120	
7	240/415	15	277	10	SWD	AWG 18	FAZ-C7/1-RT	102125	12/120	
8	240/415	15	277	10	SWD	AWG 16	FAZ-C8/1-RT	102126	12/120	
10	240/415	15	277	10	SWD	AWG 16	FAZ-C10/1-RT	102127	12/120	
13	240/415	15	277	10	SWD		FAZ-C13/1-RT	102128	12/120	
15	240/415	15	277	14	SWD		FAZ-C15/1-RT	102129	12/120	
16	240/415	15	277	14	SWD		FAZ-C16/1-RT	102130	12/120	
20	240/415	15	277	14	SWD		FAZ-C20/1-RT	102131	12/120	
25	240/415	15	277	14			FAZ-C25/1-RT	102132	12/120	
30	240/415	15	277	10			FAZ-C30/1-RT	102133	12/120	
32	240/415	15	277	10			FAZ-C32/1-RT	102134	12/120	
35	240/415	15	240	10			FAZ-C35/1-RT	102135	12/120	
40	240/415	15	240	10			FAZ-C40/1-RT	102136	12/120	
2-pole										
0.5	415	15	480Y/277	10	SWD	AWG 18	FAZ-C0,5/2-RT	102197	1/60	
1	415	15	480Y/277	10	SWD	AWG 18	FAZ-C1/2-RT	102198	1/60	
1.5	415	15	480Y/277	10	SWD	AWG 18	FAZ-C1,5/2-RT	102199	1/60	
2	415	15	480Y/277	10	SWD	AWG 18	FAZ-C2/2-RT	102200	1/60	
3	415	15	480Y/277	10	SWD	AWG 18	FAZ-C3/2-RT	102201	1/60	
4	415	15	480Y/277	10	SWD	AWG 18	FAZ-C4/2-RT	102202	1/60	
5	415	15	480Y/277	10	SWD	AWG 18	FAZ-C5/2-RT	102203	1/60	
6	415	15	480Y/277	10	SWD	AWG 18	FAZ-C6/2-RT	102204	1/60	
7	415	15	480Y/277	10	SWD	AWG 18	FAZ-C7/2-RT	102205	1/60	
8	415	15	480Y/277	10	SWD	AWG 16	FAZ-C8/2-RT	102206	1/60	
10	415	15	480Y/277	10	SWD	AWG 16	FAZ-C10/2-RT	102207	1/60	
13	415	15	480Y/277	10	SWD		FAZ-C13/2-RT	102208	1/60	
15	415	15	480Y/277	14	SWD		FAZ-C15/2-RT	102209	1/60	
16	415	15	480Y/277	14	SWD		FAZ-C16/2-RT	102210	1/60	
20	415	15	480Y/277	14	SWD		FAZ-C20/2-RT	102211	1/60	
25	415	15	480Y/277	14			FAZ-C25/2-RT	102212	1/60	
30	415	15	480Y/277	10			FAZ-C30/2-RT	102213	1/60	
32	415	15	480Y/277	10			FAZ-C32/2-RT	102214	1/60	
35	415	15	240	10			FAZ-C35/2-RT	102215	1/60	
40	415	15	240	10			FAZ-C40/2-RT	102216	1/60	
3-pole										
0.5	415	15	480Y/277	10	SWD	AWG 18	FAZ-C0,5/3-RT	102277	1/40	
1	415	15	480Y/277	10	SWD	AWG 18	FAZ-C1/3-RT	102278	1/40	
1.5	415	15	480Y/277	10	SWD	AWG 18	FAZ-C1,5/3-RT	102279	1/40	
2	415	15	480Y/277	10	SWD	AWG 18	FAZ-C2/3-RT	102280	1/40	
3	415	15	480Y/277	10	SWD	AWG 18	FAZ-C3/3-RT	102281	1/40	
4	415	15	480Y/277	10	SWD	AWG 18	FAZ-C4/3-RT	102282	1/40	
5	415	15	480Y/277	10	SWD	AWG 18	FAZ-C5/3-RT	102283	1/40	
6	415	15	480Y/277	10	SWD	AWG 18	FAZ-C6/3-RT	102284	1/40	
7	415	15	480Y/277	10	SWD	AWG 18	FAZ-C7/3-RT	102285	1/40	
8	415	15	480Y/277	10	SWD	AWG 16	FAZ-C8/3-RT	102286	1/40	
10	415	15	480Y/277	10	SWD	AWG 16	FAZ-C10/3-RT	102287	1/40	
13	415	15	480Y/277	10	SWD		FAZ-C13/3-RT	102288	1/40	
15	415	15	480Y/277	14	SWD		FAZ-C15/3-RT	102289	1/40	
16	415	15	480Y/277	14	SWD		FAZ-C16/3-RT	102290	1/40	
20	415	15	480Y/277	14	SWD		FAZ-C20/3-RT	102291	1/40	
25	415	15	480Y/277	14			FAZ-C25/3-RT	102292	1/40	
30	415	15	480Y/277	10			FAZ-C30/3-RT	102293	1/40	
32	415	15	480Y/277	10			FAZ-C32/3-RT	102294	1/40	
35	415	15	240	10			FAZ-C35/3-RT	102295	1/40	
40	415	15	240	10			FAZ-C40/3-RT	102296	1/40	

SG56412



SG56712



SG57012



FAZ-...-RT Miniature Circuit Breakers (MCBs)

Characteristic D

	Rated current I_n (A)	Rated voltage IEC/EN 60947-2 (V)	Breaking capacity acc. to IEC/EN 60947-2 (kA)	Rated voltage UL489 (V)	Breaking capacity acc. to UL489 (kA)	SWD	NFPA 79	Type Designation	Article No.	Units per package
1-pole										
	0.5	240/415	15	277	10	SWD	AWG 18	FAZ-D0,5/1-RT	102137	12/120
	1	240/415	15	277	10	SWD	AWG 18	FAZ-D1/1-RT	102138	12/120
	1.5	240/415	15	277	10	SWD	AWG 18	FAZ-D1,5/1-RT	102139	12/120
	2	240/415	15	277	10	SWD	AWG 18	FAZ-D2/1-RT	102140	12/120
	3	240/415	15	277	10	SWD	AWG 18	FAZ-D3/1-RT	102141	12/120
	4	240/415	15	277	10	SWD	AWG 18	FAZ-D4/1-RT	102142	12/120
	5	240/415	15	277	10	SWD	AWG 18	FAZ-D5/1-RT	102143	12/120
	6	240/415	15	277	10	SWD	AWG 18	FAZ-D6/1-RT	102144	12/120
	7	240/415	15	277	10	SWD	AWG 18	FAZ-D7/1-RT	102145	12/120
	8	240/415	15	277	10	SWD	AWG 16	FAZ-D8/1-RT	102146	12/120
	10	240/415	15	277	10	SWD	AWG 16	FAZ-D10/1-RT	102147	12/120
	13	240/415	15	277	14	SWD		FAZ-D13/1-RT	102148	12/120
	15	240/415	15	277	14	SWD		FAZ-D15/1-RT	102149	12/120
	16	240/415	15	277	14	SWD		FAZ-D16/1-RT	102150	12/120
	20	240/415	15	277	14	SWD		FAZ-D20/1-RT	102151	12/120
	25	240/415	15	277	10			FAZ-D25/1-RT	102152	12/120
	30	240/415	15	277	10			FAZ-D30/1-RT	102153	12/120
	32	240/415	15	277	10			FAZ-D32/1-RT	102154	12/120
	35	240/415	15	240	10			FAZ-D35/1-RT	102155	12/120
	40	240/415	15	240	10			FAZ-D40/1-RT	102156	12/120
2-pole										
	0.5	415	15	480Y/277	10	SWD	AWG 18	FAZ-D0,5/2-RT	102217	1/60
	1	415	15	480Y/277	10	SWD	AWG 18	FAZ-D1/2-RT	102218	1/60
	1.5	415	15	480Y/277	10	SWD	AWG 18	FAZ-D1,5/2-RT	102219	1/60
	2	415	15	480Y/277	10	SWD	AWG 18	FAZ-D2/2-RT	102220	1/60
	3	415	15	480Y/277	10	SWD	AWG 18	FAZ-D3/2-RT	102221	1/60
	4	415	15	480Y/277	10	SWD	AWG 18	FAZ-D4/2-RT	102222	1/60
	5	415	15	480Y/277	10	SWD	AWG 18	FAZ-D5/2-RT	102223	1/60
	6	415	15	480Y/277	10	SWD	AWG 18	FAZ-D6/2-RT	102224	1/60
	7	415	15	480Y/277	10	SWD	AWG 18	FAZ-D7/2-RT	102225	1/60
	8	415	15	480Y/277	10	SWD	AWG 16	FAZ-D8/2-RT	102226	1/60
	10	415	15	480Y/277	10	SWD	AWG 16	FAZ-D10/2-RT	102227	1/60
	13	415	15	480Y/277	14	SWD		FAZ-D13/2-RT	102228	1/60
	15	415	15	480Y/277	14	SWD		FAZ-D15/2-RT	102229	1/60
	16	415	15	480Y/277	14	SWD		FAZ-D16/2-RT	102230	1/60
	20	415	15	480Y/277	14	SWD		FAZ-D20/2-RT	102231	1/60
	25	415	15	480Y/277	10			FAZ-D25/2-RT	102232	1/60
	30	415	15	480Y/277	10			FAZ-D30/2-RT	102233	1/60
	32	415	15	480Y/277	10			FAZ-D32/2-RT	102234	1/60
	35	415	15	240	10			FAZ-D35/2-RT	102235	1/60
	40	415	15	240	10			FAZ-D40/2-RT	102236	1/60
3-pole										
	0.5	415	15	480Y/277	10	SWD	AWG 18	FAZ-D0,5/3-RT	102297	1/40
	1	415	15	480Y/277	10	SWD	AWG 18	FAZ-D1/3-RT	102298	1/40
	1.5	415	15	480Y/277	10	SWD	AWG 18	FAZ-D1,5/3-RT	102299	1/40
	2	415	15	480Y/277	10	SWD	AWG 18	FAZ-D2/3-RT	102300	1/40
	3	415	15	480Y/277	10	SWD	AWG 18	FAZ-D3/3-RT	102301	1/40
	4	415	15	480Y/277	10	SWD	AWG 18	FAZ-D4/3-RT	102302	1/40
	5	415	15	480Y/277	10	SWD	AWG 18	FAZ-D5/3-RT	102303	1/40
	6	415	15	480Y/277	10	SWD	AWG 18	FAZ-D6/3-RT	102304	1/40
	7	415	15	480Y/277	10	SWD	AWG 18	FAZ-D7/3-RT	102305	1/40
	8	415	15	480Y/277	10	SWD	AWG 16	FAZ-D8/3-RT	102306	1/40
	10	415	15	480Y/277	10	SWD	AWG 16	FAZ-D10/3-RT	102307	1/40
	13	415	15	480Y/277	14	SWD		FAZ-D13/3-RT	102308	1/40
	15	415	15	480Y/277	14	SWD		FAZ-D15/3-RT	102309	1/40
	16	415	15	480Y/277	14	SWD		FAZ-D16/3-RT	102310	1/40
	20	415	15	480Y/277	14	SWD		FAZ-D20/3-RT	102311	1/40
	25	415	15	480Y/277	10			FAZ-D25/3-RT	102312	1/40
	30	415	15	480Y/277	10			FAZ-D30/3-RT	102313	1/40
	32	415	15	480Y/277	10			FAZ-D32/3-RT	102314	1/40
	35	415	15	240	10			FAZ-D35/3-RT	102315	1/40
	40	415	15	240	10			FAZ-D40/3-RT	102316	1/40

SG56412



SG56712



SG57012



FAZ-NA, -RT Miniature Circuit Breakers

Accessories:

Auxiliary switch for subsequent installation	Z-IHK-NA	113895
Tripping signal contact for subsequent installation	Z-NHK	248434
Shunt trip release	FAZ-XAA-NA12-110VAC	102037
	FAZ-XAA-NA110-415VAC	102036
Switching interlock	IS/SPE-1TE	101911
	Z-IS/SPE-1TE	274418

Specifications FAZ-NA, -RT

Technical data IEC/EN

	FAZ-...-NA, -RT
Productstandard	IEC/EN 60947-2
Number of poles	1, 2, 3
Mechanical specifications	
Device width	17.7mm (1-pole), 35.4 mm (2-poles), 53.1 mm (3-poles)
Frame size	45 mm
Socket size	105 mm
Device depth	60 mm
Terminals	lift terminal / ring-tongue
Terminal capacity rigid solid/stranded wire	1-25 mm ²
Terminal screw	M5 (with slotted screw Pozidriv PZ2)
Terminal torque	max. 2.4 Nm
Snap on fixing	tristable (on DIN Rail acc. to IEC/EN 60715)
Degree of Protection (DIN VDE 0470)	
Surface mounted	IP 20
Built-in behind panel	IP 40
Contact position indicator	red / green
Electrical specifications	
Rated voltage	U_n 240/415 V AC
Rated current	I_n 0.5, 1, 1.5, 2, 3, 4, 5, 6, 7, 8, 10, 13, 15, 16, 20, 25, 30, 32, 35, 40 A
Rated insulation voltage	U_i 440 V AC
Rated impulse withstand voltage	U_{imp} 4 kV (1.2/50)µsec
Tripping characteristic	
Conventional non-tripping current	$I_{nt} = 1.05 I_n$
Conventional tripping current	$I_t = 1.30 I_n$
Reference temperature	30 °C
Temperature factor	0.5% /K
Instantaneous tripping current	I_{mt} type B: $3 I_n < I_{mt} = 5 I_n$; $t(I_{mt}) < 0.1$ sec (IEC/EN 60898-1) type C: $5 I_n < I_{mt} = 10 I_n$; $t(I_{mt}) < 0.1$ sec (IEC/EN 60898-1) type D: $10 I_n < I_{mt} = 20 I_n$; $t(I_{mt}) < 0.1$ sec (IEC/EN 60898-1)
Rated short-circuit braking capacity	I_{cu} 15 kA
Service short circuit capacity	I_{cs} 7.5 kA
Selectivity class	3 (acc. to EN 60898)
Number of electrical operations	> 1500
Number of mechanical operations	> 10000
Climatic conditions	acc. to IEC 68-2 (25..55°C / 90..95% RH)
Operating temperature range	-40°C to +75°C

Connection diagram

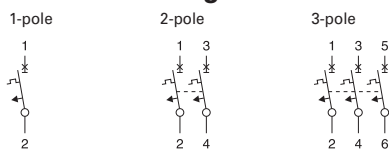

Specifications FAZ-NA, -RT

Technical data UL

		FAZ-...-NA, -RT
Productstandard		UL 489 CSA C22.2 No. 5-02
Number of poles		1, 2, 3
Mechanical specifications		
Device width		0.697 in. (1-pole), 1.394 in. (2-poles), 2.090 in. (3-poles)
Frame size		1.772 in.
Socket size		4.134 in.
Device depth		2.362 in.
Terminals		lift terminal / ring-tongue
Terminal capacity		1 Wire: #18-6 AWG (Cu only) 2 Wires: #18-10 AWG (Cu only)
Terminal screw		M5 (with slotted screw Pozidriv PZ2)
Terminal torque		#18-12 AWG: 21 lb-in #10-8 AWG: 25 lb-in #6 AWG: 36 lb-in
Snap on fixing		tristable (on DIN Rail acc. to IEC/EN 60715)
Contact position indicator		red / green
Electrical specifications		
Rated voltage	U_n	0.5-32 A: 480Y/277 V AC, 35-40 A: 240 V AC
Rated current	I_n	0.5, 1, 1.5, 2, 3, 4, 5, 6, 7, 8, 10, 13, 15, 16, 20, 25, 30, 32, 35, 40 A
Tripping characteristic		
Conventional non-tripping current	I_{nt}	$I_{nt} = 1.00 I_n$
Conventional tripping current	I_t	$I_t = 1.35 I_n$
Reference temperature		40 °C
Temperature factor		0.5% /K
Instantaneous tripping current	I_{mt}	type C: $5 I_n < I_{mt} = 10 I_n$; $t(I_{mt}) < 0.1$ sec type D: $10 I_n < I_{mt} = 20 I_n$; $t(I_{mt}) < 0.1$ sec
Current interrupting rating		10 kA, 14 kA (types D13, B/C/D15, 16, 20, B/C25 A)
Current-Limiting at 240 V / 10 kA		1p, 2p, 3p to $I^2t = 43 \text{ kA}^2\text{s}$ and $I_{peak} = 6.2 \text{ kA}$
Current-Limiting at 480Y/277 V / 10 kA		1p, 2p, 3p to $I^2t = 60 \text{ kA}^2\text{s}$ and $I_{peak} = 6.2 \text{ kA}$
Current-Limiting at 480Y/277 V / 14 kA		1p, 2p, 3p to $I^2t = 65 \text{ kA}^2\text{s}$ and $I_{peak} = 7.5 \text{ kA}$
Selectivity class		3 (acc. to EN 60898)
Number of electrical operations		6000
Number of mechanical operations		10000
Climatic conditions		acc. to IEC 68-2 (25..55°C / 90..95% RH)
Operating temperature range		-5°C to +40°C

Connection diagram

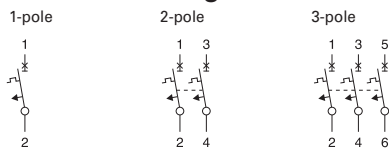

Dimensions (mm) FAZ-...-NA, -RT

1-pole

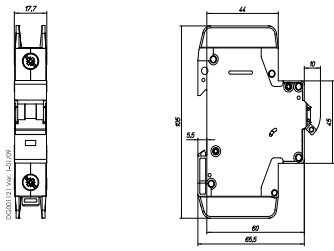

2-pole

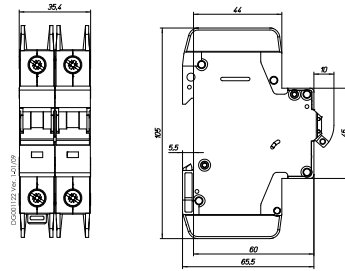

3-pole

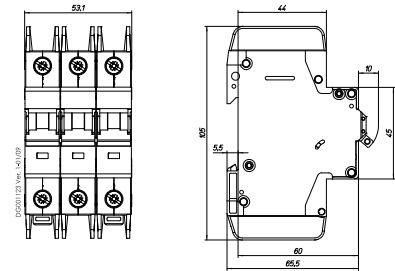

Tripping Characteristic FAZ-...-NA, -RT

Characteristics C and D - EN/IEC 60947-2

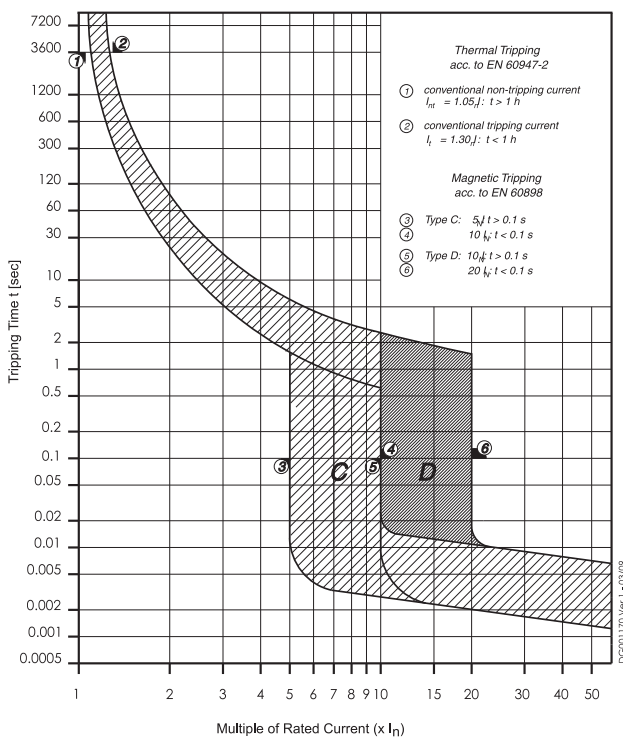

Characteristics C and D - UL 489

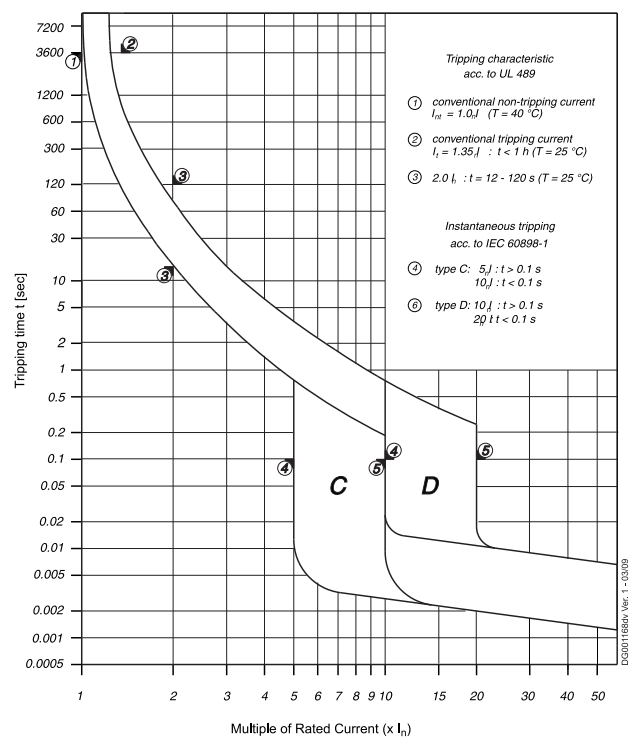

Internal Resistance FAZ-...-NA, -RT

Type C

At room temperature (single pole)

I_n [A]	Z^* [mΩ]	R [mΩ]
0.5	6400	6300
1	1100	1080
1.5	560	550
2	340	330
3	132	130
4	86	85
5	70	69
6	31	30
7	28	27
8	20	19.6
10	15.8	15.5
13	12.3	12.1
15	7.1	7.0
16	7.1	7.0
20	6.0	5.9
25	4.1	4.0
30	2.8	2.7
32	2.8	2.7
35	2.5	2.5
40	2.1	2.1

* 50Hz

Type D

At room temperature (single pole)

I_n [A]	Z^* [mΩ]	R [mΩ]
0.5	6400	6300
1	770	755
1.5	460	450
2	250	245
3	132	130
4	86	85
5	57	56
6	31	30
7	28	27
8	18	17.6
10	13.5	13.2
13	10.5	10.3
15	5.9	5.8
16	5.9	5.8
20	4.0	3.9
25	3.4	3.3
30	2.5	2.5
32	2.5	2.5
35	2.5	2.5
40	2.0	2.0

* 50Hz

Power Loss at I_n FAZ-...-NA, -RT

Type C

I_n [A]	1p	2p	3p
	P^* [W]	P^* [W]	P^* [W]
0.5	1.6	3.2	4.7
1	1.1	2.2	3.4
1.5	1.3	2.6	3.9
2	1.4	2.8	4.3
3	1.2	2.4	3.6
4	1.4	2.9	4.3
5	1.9	3.7	5.6
6	1.2	2.3	3.5
7	1.4	2.8	4.3
8	1.4	2.8	4.2
10	1.8	3.6	5.3
13	2.4	4.7	7.1
15	1.9	3.8	5.6
16	2.1	4.3	6.4
20	2.9	5.8	8.7
25	3.1	6.2	9.3
30	3.0	6.0	9.0
32	3.4	6.8	10.2
35	3.7	7.4	11.0
40	4.0	8.1	12.1

*50Hz

Type D

I_n [A]	1p	2p	3p
	P^* [W]	P^* [W]	P^* [W]
0.5	1.6	3.2	4.8
1	0.8	1.5	2.3
1.5	1.0	2.1	3.1
2	1.0	2.1	3.1
3	1.2	2.4	3.6
4	1.4	2.9	4.3
5	1.5	2.9	4.4
6	1.2	2.3	3.5
7	1.4	2.8	4.3
8	1.2	2.4	3.7
10	1.5	3.0	4.5
13	2.0	4.1	6.1
15	1.5	3.1	4.6
16	1.7	3.5	5.2
20	1.8	3.7	5.5
25	2.6	5.1	7.7
30	2.7	5.4	8.1
32	3.1	6.2	9.3
35	3.8	7.6	11.3
40	3.9	7.8	11.6

*50Hz

Maximum Let-Through Energy FAZ-...-NA, -RT

Type C (0.5 - 32 A), 277 V

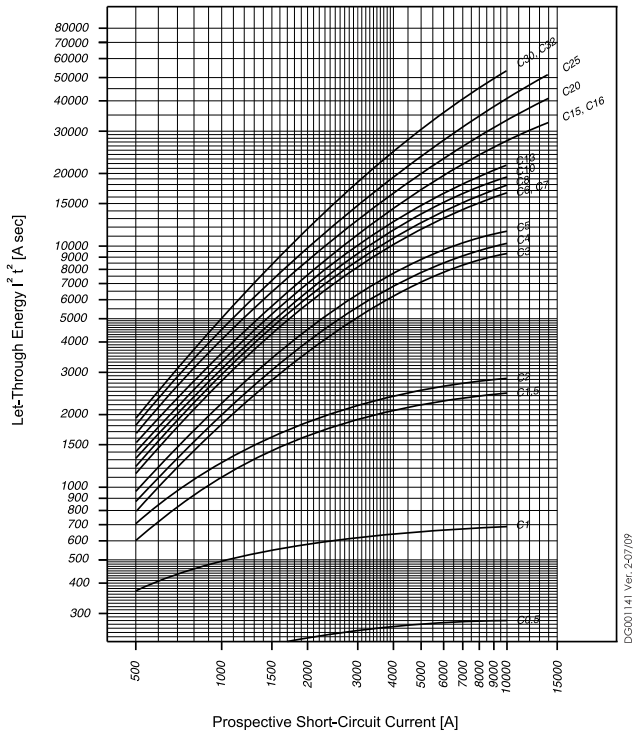

Type C (35 - 40 A), 240 V

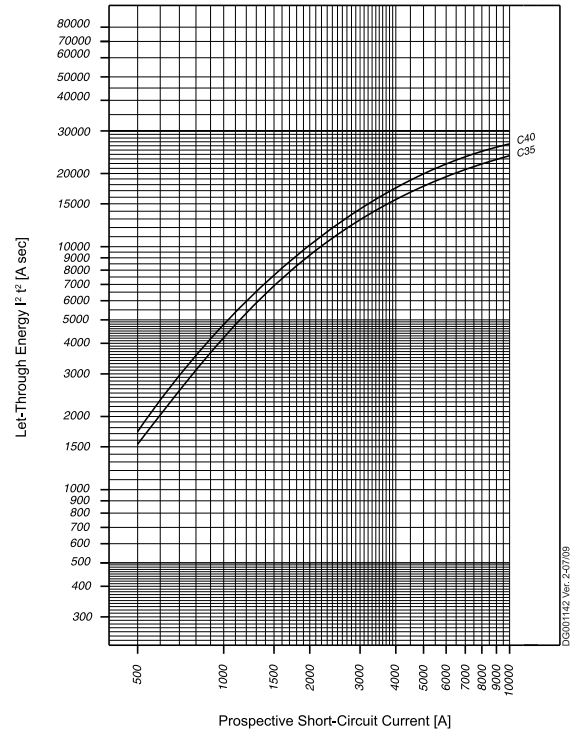

Type D (0.5 - 32 A), 277 V

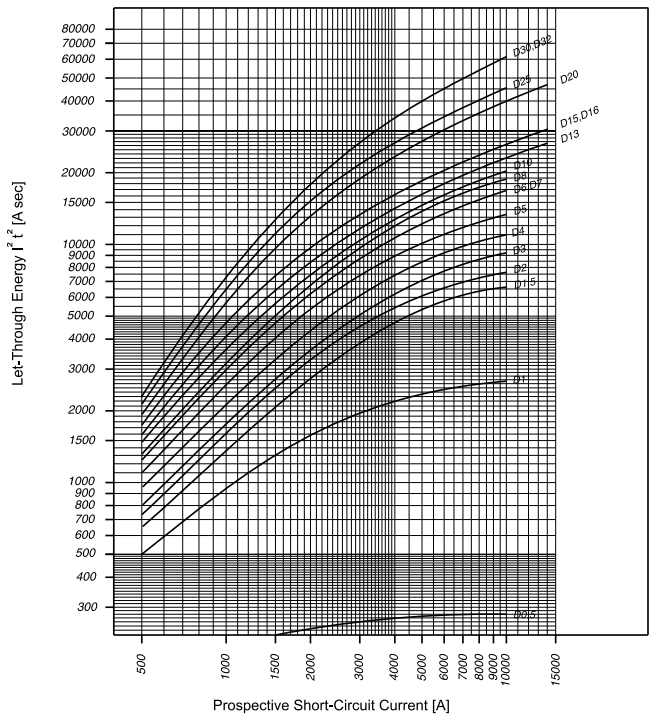

Type D (35 - 40 A), 240 V

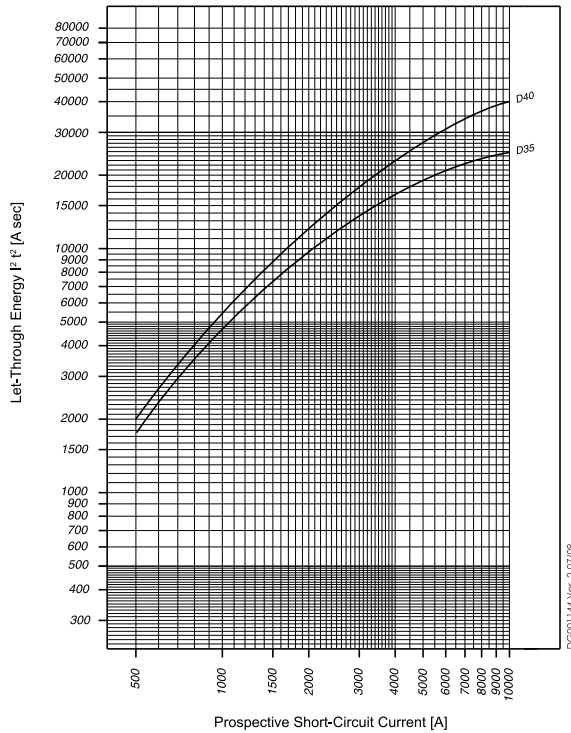

Maximum Let-Through Current FAZ-...-NA, -RT

Type C (0.5 - 32 A), 277 V

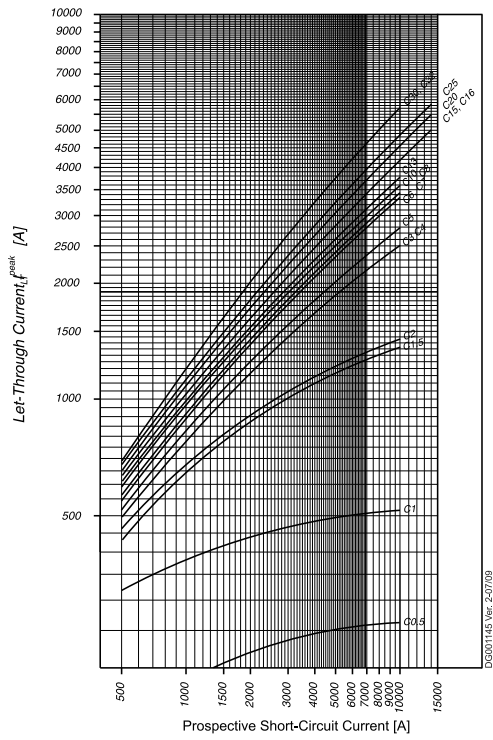

Type C (35 - 40 A), 240 V

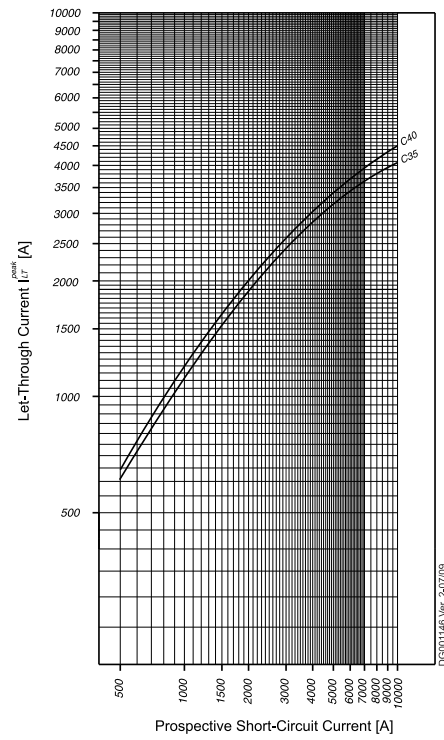

Type D (0.5 - 32 A), 277 V

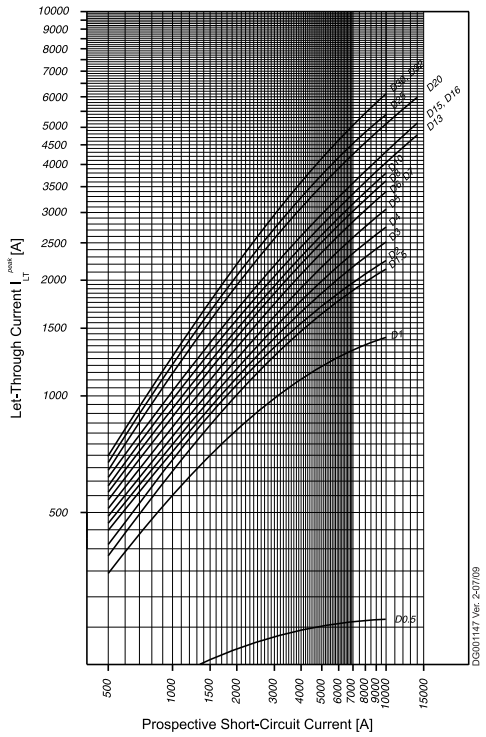

Type D (35 - 40 A), 240 V

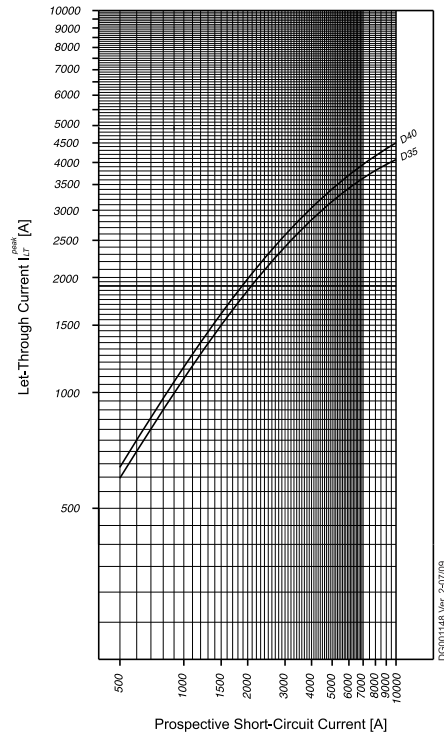

Miniature Circuit Breakers FAZ-NA-DC

SG56612



FAZ-NA-DC

- High-quality miniature circuit breakers for DC-applications
- Contact position indicator red - green
- Guide for secure terminal connection (not for FAZ-NA)
- 3-position DIN rail clip, permits removal from existing busbar system
- Comprehensive range of accessories suitable for subsequent installation
- Rated currents up to 40 A
- Tripping characteristic C
- Rated breaking capacity 10 kA according to IEC/EN 60947-2
- Up to 125 V DC per pole

FAZ-...-NA-DC Miniature Circuit Breakers (MCBs)

Characteristic C

Rated current I_n (A)	Rated voltage IEC/EN 60947-2 (V DC)	Breaking capacity acc. to IEC/EN 60947-2 (kA)	Rated voltage UL489 (V)	Breaking capacity acc. to UL489 (kA)	SWD	NFPA 79	Type Designation	Article No.	Units per package
1-pole									
2	220	10	125	10			FAZ-C2/1-NA-DC	113752	12/120
3	250	10	125	10			FAZ-C3/1-NA-DC	113753	12/120
4	250	10	125	10			FAZ-C4/1-NA-DC	113754	12/120
5	250	10	125	10			FAZ-C5/1-NA-DC	113755	12/120
6	250	10	125	10			FAZ-C6/1-NA-DC	113756	12/120
7	250	10	125	10			FAZ-C7/1-NA-DC	113757	12/120
8	250	10	125	10			FAZ-C8/1-NA-DC	113758	12/120
10	250	10	125	10			FAZ-C10/1-NA-DC	113759	12/120
13	250	10	125	10			FAZ-C13/1-NA-DC	113760	12/120
15	250	10	125	10			FAZ-C15/1-NA-DC	113761	12/120
16	250	10	125	10			FAZ-C16/1-NA-DC	113762	12/120
20	250	10	125	10			FAZ-C20/1-NA-DC	113763	12/120
25	250	10	125	10			FAZ-C25/1-NA-DC	113764	12/120
30	250	10	125	10			FAZ-C30/1-NA-DC	113765	12/120
32	250	10	125	10			FAZ-C32/1-NA-DC	113766	12/120
35	250	10	125	10			FAZ-C35/1-NA-DC	113767	12/120
40	250	10	125	10			FAZ-C40/1-NA-DC	113768	12/120

SG56512



SG56612



2-pole									
2	440	10	250	10			FAZ-C2/2-NA-DC	137239	1/60
3	500	10	250	10			FAZ-C3/2-NA-DC	137250	1/60
4	500	10	250	10			FAZ-C4/2-NA-DC	137251	1/60
5	500	10	250	10			FAZ-C5/2-NA-DC	137252	1/60
6	500	10	250	10			FAZ-C6/2-NA-DC	120638	1/60
7	500	10	250	10			FAZ-C7/2-NA-DC	120639	1/60
8	500	10	250	10			FAZ-C8/2-NA-DC	120640	1/60
10	500	10	250	10			FAZ-C10/2-NA-DC	120641	1/60
13	500	10	250	10			FAZ-C13/2-NA-DC	120642	1/60
15	500	10	250	10			FAZ-C15/2-NA-DC	120643	1/60
16	500	10	250	10			FAZ-C16/2-NA-DC	120644	1/60
20	500	10	250	10			FAZ-C20/2-NA-DC	120645	1/60
25	500	10	250	10			FAZ-C25/2-NA-DC	120646	1/60
30	500	10	250	10			FAZ-C30/2-NA-DC	120647	1/60
32	500	10	250	10			FAZ-C32/2-NA-DC	120648	1/60
35	500	10	250	10			FAZ-C35/2-NA-DC	120649	1/60
40	500	10	250	10			FAZ-C40/2-NA-DC	120650	1/60

Specifications FAZ-NA-DC

Technical data

		FAZ-NA-DC
Productstandard		UL 489, CSA C22.2 No 5-02
Number of poles		1, 2
Mechanical specifications		
Device width		1 pole = 0.697 inch, 2 poles = 1.394 inch
Frame size		1.772 inch
Socket size		4.134 inch
Device depth		2.362 inch
Terminals		lift terminal / ring-tongue
Terminal capacity rigid solid/stranded wire		1 Wire: AWG 18-6 (Cu only) 2 Wires: AWG 18-10 (Cu only)
Terminal screw		M5 (with slotted screw Pozidriv PZ2)
Terminal torque		#18-12 AWG: 21 lb-in #10-8 AWG: 25 lb-in #6 AWG: 36 lb-in
Snap on fixing		tristable (on DIN Rail acc. to IEC/EN 60715)
Finger proof		acc.to VBG4, ÖVE EN-6
Contact position indicator		red / green
Electrical specifications		
Rated voltage DC	U_n	125 V d.c. (1p) 250 V d.c. (2p)
Rated current	I_n	2, 3, 4, 5, 6, 7, 8, 10, 13, 15, 16, 20, 25, 30, 32, 35, 40 A
Rated impulse withstand voltage	U_{imp}	4 kV (1.2/50) μ sec
Tripping characteristic		
Conventional non-tripping current		$I_{nt}=1.0 I_n$
Conventional tripping current		$I_t=1.35 I_n$
Reference temperature		40 °C
Temperature factor		0.5% /K
Instantaneous tripping current	I_{mt}	$7 I_n < I_{mt} = 15 I_n ; t(I_{mt}) < 0.1 \text{ sec}$
Current interrupting rating		10 kA
Number of electrical operating cycles		6000
Number of mechanical operating cycles		10000
Climatic conditions		acc. to IEC 68-2 (25..55°C / 90..95% RH)
Operating temperature range		-25°C to +55°C

Connection diagram

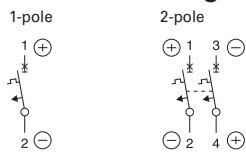

Dimensions (mm) FAZ-NA-DC

1-pole

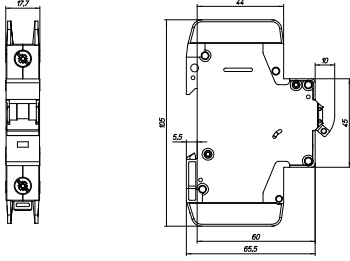

2-pole

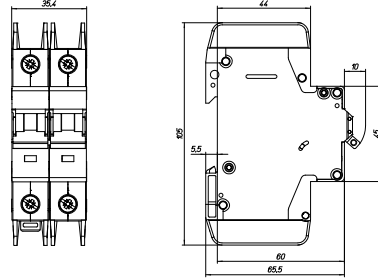

Tripping Characteristic FAZ-NA-DC

Characteristics C - UL 489

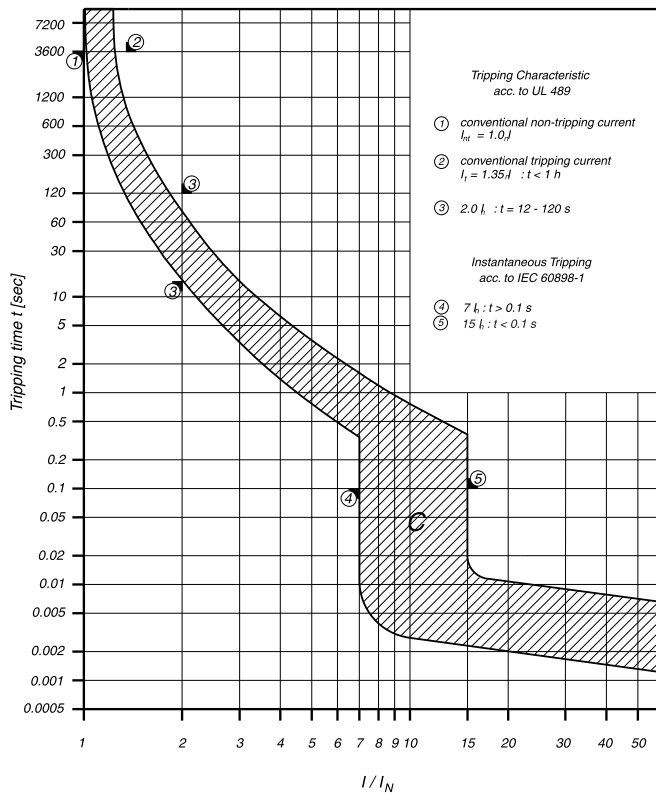





Miniature Circuit Breakers AZ

SG51412







- High-quality miniature circuit breakers for commercial and industrial applications
- Contact position indicator red - green
- Accessories suitable for subsequent installation
- Rated currents up to 125 A
- Tripping characteristics C, D
- Rated breaking capacity up to 25 kA according to EN 60947-2

AZ Miniature Circuit Breakers (MCBs) Characteristic C

	Rated current I_n (A)	Type Designation	Article No.	Units per package
SG51212 	1-pole			
	20	AZ-C20	211769	12
	25	AZ-C25	211774	12
	32	AZ-C32	211779	12
	40	AZ-C40	211784	12
	50	AZ-C50	211789	12
	63	AZ-C63	211794	12
	80	AZ-C80	211799	12
	100	AZ-C100	211804	12
125	AZ-C125	211809	12	
SG51312 	2-pole			
	20	AZ-2-C20	211770	2
	25	AZ-2-C25	211775	2
	32	AZ-2-C32	211780	2
	40	AZ-2-C40	211785	2
	50	AZ-2-C50	211790	2
	63	AZ-2-C63	211795	2
	80	AZ-2-C80	211800	2
	100	AZ-2-C100	211805	2
125	AZ-2-C125	211810	2	
wa_sg00314 	3-pole			
	20	AZ-3-C20	211771	1
	25	AZ-3-C25	211776	1
	32	AZ-3-C32	211781	1
	40	AZ-3-C40	211786	1
	50	AZ-3-C50	211791	1
	63	AZ-3-C63	211796	1
	80	AZ-3-C80	211801	1
	100	AZ-3-C100	211806	1
125	AZ-3-C125	211811	1	
wa_sg00214 	3+N-pole			
	20	AZ-3N-C20	211773	1
	25	AZ-3N-C25	211778	1
	32	AZ-3N-C32	211783	1
	40	AZ-3N-C40	211788	1
	50	AZ-3N-C50	211793	1
	63	AZ-3N-C63	211798	1
	80	AZ-3N-C80	211803	1
	100	AZ-3N-C100	211808	1
125	AZ-3N-C125	211813	1	
SG51412 	4-pole			
	20	AZ-4-C20	211772	1
	25	AZ-4-C25	211777	1
	32	AZ-4-C32	211782	1
	40	AZ-4-C40	211787	1
	50	AZ-4-C50	211792	1
	63	AZ-4-C63	211797	1
	80	AZ-4-C80	211802	1
	100	AZ-4-C100	211807	1
125	AZ-4-C125	211812	1	

AZ Miniature Circuit Breakers (MCBs) Characteristic D

	Rated current I_n (A)	Type Designation	Article No.	Units per package
SG51212 	1-pole			
	50	AZ-D50	211814	12
	63	AZ-D63	211818	12
	80	AZ-D80	211822	12
	100	AZ-D100	211826	12
SG51312 	2-pole			
	50	AZ-2-D50	211815	2
	63	AZ-2-D63	211819	2
	80	AZ-2-D80	211823	2
	100	AZ-2-D100	211827	2
wa_sg00314 	3-pole			
	50	AZ-3-D50	211816	1
	63	AZ-3-D63	211820	1
	80	AZ-3-D80	211824	1
	100	AZ-3-D100	211828	1
wa_sg00214 	3+N-pole			
	50	AZ-3N-D50	211817	1
	63	AZ-3N-D63	211821	1
	80	AZ-3N-D80	211825	1
	100	AZ-3N-D100	211829	1

Specifications | Miniature Circuit Breakers AZ

Description

- Independent switching contacts
- With isolator function, meets the requirements of insulation coordination, distance between contacts ≥ 4 mm, for secure isolation

Accessories:

Auxiliary switch for subsequent installation (0.5 MU)	Z-LHK	248440
Shunt trip release for subsequent installation (1.5 MU)	Z-LHASA/230	248442
	Z-LHASA/24	248441
Tripping interlock	LH-SPL	285752
	LHSP-E	215999
Switchoff interlock	LHSP-A	216000

Technical Data

AZ

Electrical

Standards	IEC/EN 60947-2
Rated operating voltage	230/400 V AC
	60 V DC (per pole)
Limiting breaking capacity acc. to IEC/EN 60947-2	
Characteristic C	
$I_n = 20-63$ A	25 kA
$I_n = 80-100$ A	20 kA
$I_n = 125$ A	15 kA
Characteristic D	
$I_n = 20-63$ A	25 kA
$I_n = 80$ A	20 kA
$I_n = 100$ A	15 kA
Characteristic	Similar: C, D
Max. back-up fuse	200 A gL/gG
Selectivity class	Compliant with class 3
Lifespan	Operations >10000
Direction of incoming supply	Any

Mechanical

Standard front dimensions	45 mm
Device height	90 mm
Terminal protection	Finger and back-of-proof to BGV A2
Mounting width per pole	27 mm
Mounting	Top-hat rail to IEC/EN 60715
Terminals top and bottom	Lift terminals
Terminal capacity (solid)	2.5 – 50 mm ²

Connection diagram

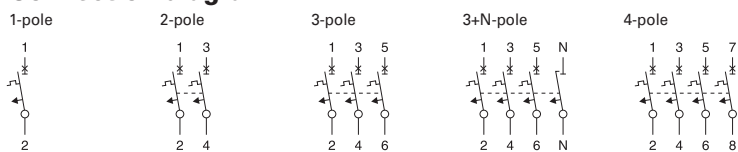

Dimensions (mm)

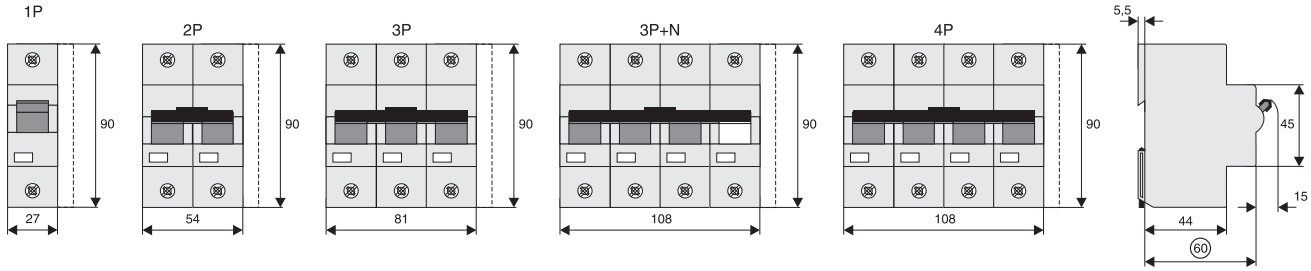

Effect of ambient temperature AZ

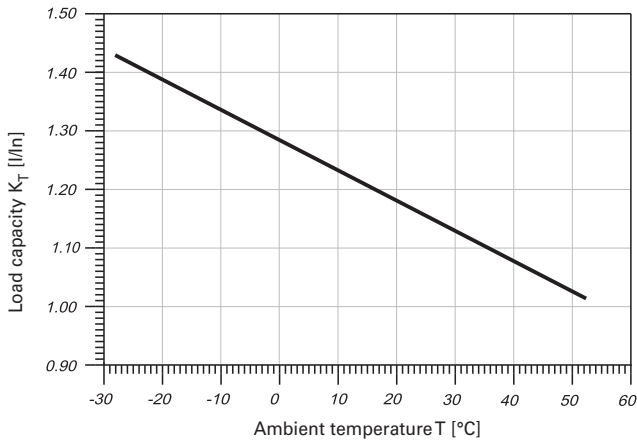

Permitted permanent load at ambient temperature T [°C] with n devices: $I_{DL} = I_n K_T(T) K_N(N)$.

Maximum Let-Through Energy AZ

Maximum let-through energy AZ, characteristic C, 1-pole

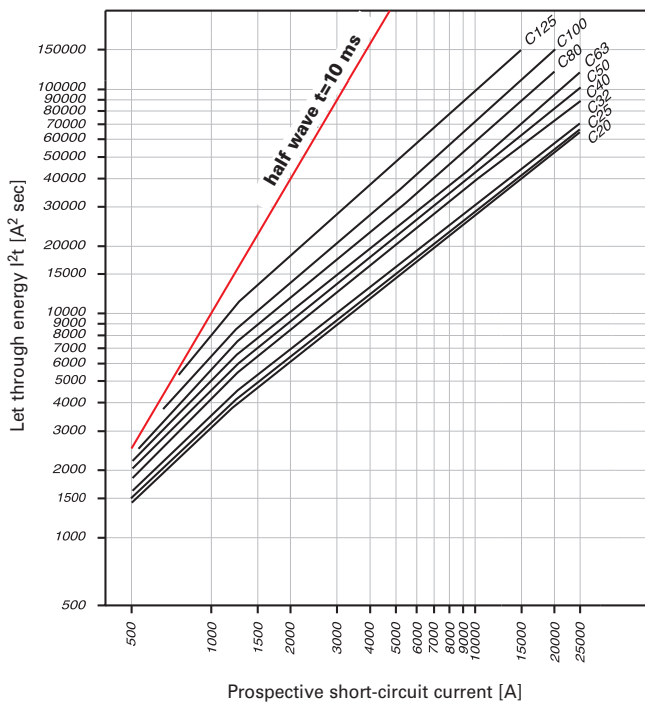

Maximum let-through energy AZ, characteristic D, 1-pole

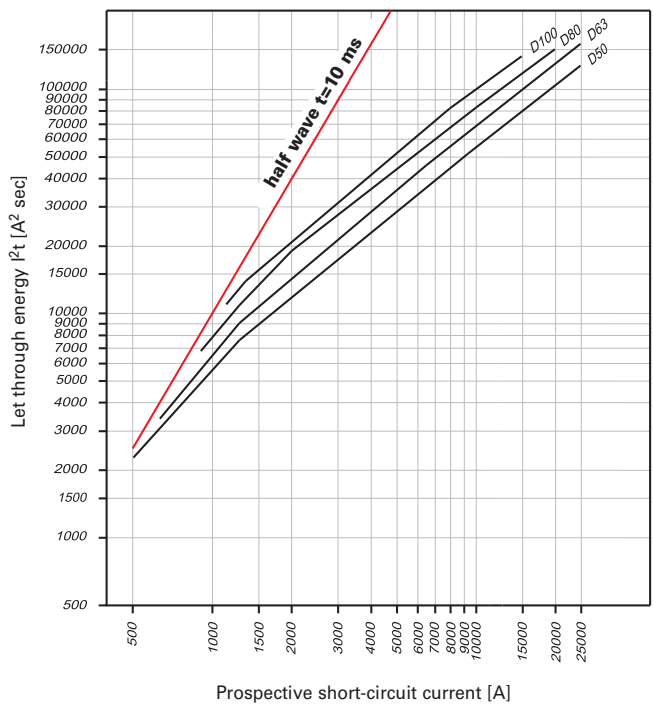

Determined according to EN 60898-1.

Maximum Let-Through Current AZ

Type C

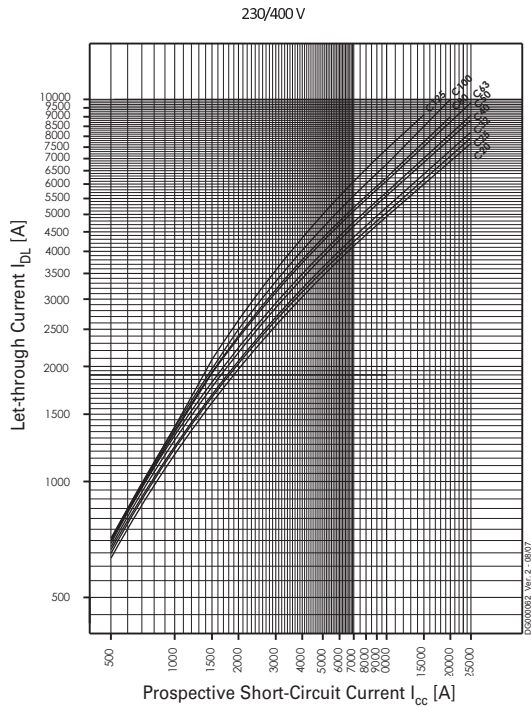

Type D

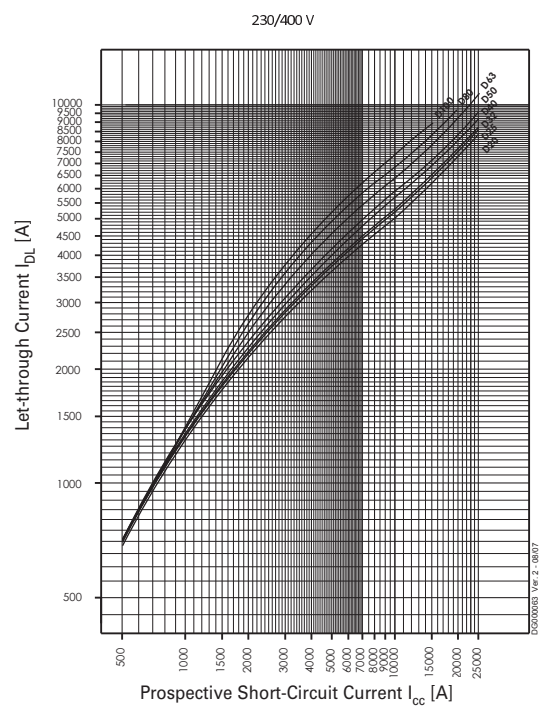

Short Circuit Selectivity AZ

In case of short circuit, there is selectivity between the miniature circuit breakers AZ and the upstream protection devices up to the specified values of the selectivity limit current I_s [kA] (i. e. in case of short-circuit currents I_{ks} under I_s , only the MCB will trip, in case of short circuit currents above this value both protective devices will respond).

AZ towards back-up fuses D01, D02, D03

Rated current I_n AZ in A	Rated current of the back-up fuse in A						
	25	35	50	63	80	100	
C Characteristic	20	0,5	1,0	2,0	2,9	3,9	7,6
	25		1,0	1,9	2,8	3,8	7,3
	32		1,0	1,8	2,7	3,6	7,0
	40			1,6	2,2	3,0	5,6
	50				2,1	2,8	5,2
	63					2,7	4,8
	80						4,3
	100						
	125						
	D -Characteristic	20	0,5	0,9	1,7	2,5	3,4
25			0,9	1,6	2,3	3,2	6,2
32			0,9	1,5	2,3	3,0	6,0
40				1,4	2,0	2,6	4,7
50					1,8	2,3	4,3
63						2,1	3,7
80							3,1
100							
125							

AZ towards back-up fuses NH Gr. 00

Rated current I_n AZ in A	Rated current of the back-up fuse in A										
	25	35	40	50	63	80	100	125	160	200	
C Characteristic	20	0,5	1,0	1,3	1,9	2,7	3,7	6,7	17,0	25,0	25,0
	25		0,9	1,3	1,8	2,6	3,5	6,5	17,0	25,0	25,0
	32		0,9	1,2	1,7	2,4	3,3	6,0	15,0	23,0	25,0
	40				1,4	2,1	2,9	4,8	12,0	18,0	25,0
	50					1,9	2,7	4,5	11,0	17,0	25,0
	63							4,2	10,0	15,0	25,0
	80							3,8	8,5	12,0	25,0
	100								7,0	10,0	25,0
	125									7,5	25,0
	D -Characteristic	20	<0,5	0,8	1,1	1,5	2,3	3,1	5,6	16,0	25,0
25			0,7	1,0	1,4	2,1	3,0	5,3	14,0	23,0	25,0
32			0,7	1,0	1,3	2,1	2,9	5,0	13,0	22,0	25,0
40					1,1	1,8	2,5	4,2	10,0	15,0	25,0
50						1,6	2,3	3,8	8,5	13,0	22,0
63							2,1	3,2	7,0	10,5	18,0
80								2,8	5,5	8,4	15,0
100									4,8	7,5	12,5
125											

AZ towards NZM 1

Short circuit selectivity **characteristic C** towards **NZM***)

AZ	NZM...1-A gL/gG					
I _n [A]	40	50	63	80	100	125
20	0.3	0.4	0.5	0.75	0.9	1.25
25	0.3	0.4	0.5	0.7	0.9	1.2
32		0.4	0.5	0.7	0.85	1.2
40			0.5	0.6	0.85	1.1
50				0.6	0.85	1.1
63					0.8	1
80						1
100						
125						

Short circuit selectivity **characteristic D** towards **NZM***)

AZ	NZM...1-A gL/gG					
I _n [A]	40	50	63	80	100	125
50						
63						
80						
100						

 no selectivity

AZ towards NZM 2

Short circuit selectivity **characteristic C** towards **NZM***)

AZ	NZM...2-A gL/gG								
I _n [A]	40	50	63	80	100	125	160	200	250
20	0.3	0.4	0.5	0.75	0.9	1.25	1.8	2.5	3.5
25	0.3	0.4	0.5	0.7	0.9	1.2	1.7	2.4	3.3
32		0.4	0.5	0.7	0.85	1.2	1.65	2.3	3.2
40			0.5	0.6	0.85	1.1	1.5	2.1	2.9
50				0.6	0.85	1.1	1.5	2	2.8
63					0.8	1	1.4	1.8	2.5
80						1	1.4	1.8	2.4
100							1.3	1.7	2.3
125								1.6	2.1

Short circuit selectivity **characteristic D** towards **NZM***)

AZ	NZM...2-A gL/gG								
I _n [A]	40	50	63	80	100	125	160	200	250
50							1	1.4	2.6
63							1	1.3	2.3
80									2.1
100									

 no selectivity

Back-up Protection AZ

The up-stream protective devices will protect the down-stream AZ up to the short-circuit current specified.

AZ and NZM(B)(C)(N)(H)1

I_n [A]	AZ-$I_n/1(2,3,4)$ / C(D) + NZMB1 $U_e = 230/400$ V
20	25 kA
25	25 kA
32	25 kA
40	25 kA
50	25 kA
63	25 kA
80	25 kA
100	25 kA
125	25 kA

I_n [A]	AZ-$I_n/1(2,3,4)$ / C(D) + NZMC1 $U_e = 230/400$ V
20	36 kA
25	36 kA
32	36 kA
40	36 kA
50	36 kA
63	36 kA
80	36 kA
100	36 kA
125	36 kA

I_n [A]	AZ-$I_n/1(2,3,4)$ / C(D) + NZMN1 $U_e = 230/400$ V
20	50 kA
25	50 kA
32	50 kA
40	50 kA
50	50 kA
63	50 kA
80	50 kA
100	50 kA
125	50 kA

I_n [A]	AZ-$I_n/1(2,3,4)$ / C(D) + NZMH1 $U_e = 230/400$ V
20	80 kA
25	80 kA
32	80 kA
40	80 kA
50	80 kA
63	80 kA
80	80 kA
100	80 kA
125	80 kA

AZ and NZM(B)(C)(N)(H)2

I_n [A]	AZ-$I_n/1(2,3,4)$ / C(D) + NZMB2 $U_e = 230/400$ V
20	25 kA
25	25 kA
32	25 kA
40	25 kA
50	25 kA
63	25 kA
80	25 kA
100	25 kA
125	25 kA

I_n [A]	AZ-$I_n/1(2,3,4)$ / C(D) + NZMC2 $U_e = 230/400$ V
20	36 kA
25	36 kA
32	36 kA
40	36 kA
50	36 kA
63	36 kA
80	36 kA
100	36 kA
125	36 kA

I_n [A]	AZ-$I_n/1(2,3,4)$ / C(D) + NZMN2 $U_e = 230/400$ V
20	50 kA
25	50 kA
32	50 kA
40	50 kA
50	50 kA
63	50 kA
80	50 kA
100	50 kA
125	50 kA

I_n [A]	AZ-$I_n/1(2,3,4)$ / C(D) + NZMH2 $U_e = 230/400$ V
20	65 kA
25	65 kA
32	65 kA
40	65 kA
50	65 kA
63	65 kA
80	65 kA
100	65 kA
125	65 kA

Load capacity in case of block installation AZ

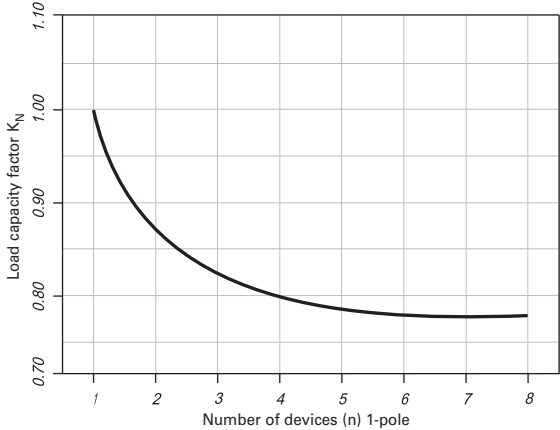





Main Load Disconnect Switch (Isolator) IS

SG10911





- Load circuit breaker with isolating function
- Highly wear resistant contacts
- Quick make
- Terminal capacity 50 mm²
- Compatible busbars
- 1-, 2-, 3-, 4-pole

Main Load Disconnect Switch (Isolator) IS

	Rated Current (A)	Poles	Type Designation	Article No.	Units per package
 SG10611	16	1	IS-16/1	276254	12/120
	16	2	IS-16/2	276255	1/60
	16	3	IS-16/3	276256	1/40
	16	4	IS-16/4	276257	1/30
	20	1	IS-20/1	276258	12/120
	20	2	IS-20/2	276259	1/60
	20	3	IS-20/3	276260	1/40
	20	4	IS-20/4	276261	1/30
 SG10711	25	1	IS-25/1	276262	12/120
	25	2	IS-25/2	276263	1/60
	25	3	IS-25/3	276264	1/40
	25	4	IS-25/4	276265	1/30
	32	1	IS-32/1	276266	12/120
	32	2	IS-32/2	276267	1/60
	32	3	IS-32/3	276268	1/40
	32	4	IS-32/4	276269	1/30
	40	1	IS-40/1	276270	12/120
	40	2	IS-40/2	276271	1/60
 SG10811	40	3	IS-40/3	276272	1/40
	40	4	IS-40/4	276273	1/30
	63	1	IS-63/1	276274	12/120
	63	2	IS-63/2	276275	1/60
	63	3	IS-63/3	276276	1/40
	63	4	IS-63/4	276277	1/30
	80	1	IS-80/1	276278	12/120
	80	2	IS-80/2	276279	1/60
	80	3	IS-80/3	276280	1/40
	80	4	IS-80/4	276281	1/30
 SG10911	100	1	IS-100/1	276282	12/120
	100	2	IS-100/2	276283	1/60
	100	3	IS-100/3	276284	1/40
	100	4	IS-100/4	276285	1/30
	125	1	IS-125/1	276286	12/120
	125	2	IS-125/2	276287	1/60
	125	3	IS-125/3	276288	1/40
	125	4	IS-125/4	276289	1/30

Accessories

	Description	Type Designation	Article No.	Units per package
 SG47812	Switching interlock without lock for Isolators, RCDs, combined RCD/MCBs, ...	IS/SPE-1TE	101911	5/30
 sg01215	Terminal cover	Z-IS/AK-1TE	276290	10/600

Switching interlock IS/SPE-1TE

- Without lock
- Also suitable for PFIM, CF16, PKNM, KKN6

Terminal Cover Caps Z-IS/AK-1TE

- Can be sealed with leads
- Modular design, width 1 MU

Specifications | Main Load Disconnect Switch (Isolator) IS

Description

- Load circuit breaker with isolating function
- Design according to IEC/EN 60947-3
- Highly wear resistant contacts
- Quick make, black toggle
- Terminal capacity 50 mm²
- Compatible busbars with switchgear series Xpole by use of the mouth terminal in combination with standard fork busbar

Technical Data

	IS-16	IS-20	IS-25	IS-32	IS-40	IS-63	IS-80	IS-100	IS-125
Electrical									
Design	according to IEC/EN 60947-3								
Rated voltage	240/415 V								
Frequency	50/60 Hz								
Rated insulation voltage	U_i	690 V~							
Rated peak withstand voltage	U_{imp}	6 kV							
Pollution degree	3								
Rated short-time withstand current	I_{cw}	2 kA							
Rated short-circuit making capacity	I_{cm}	2.8 kA							
Rated current									
240/415V, AC23A	16 A	20 A	25 A	32 A	40 A	63 A	80 A	100 A	125 A
Number of poles	1-, 2-, 3-, 4-pole								
Maximum back-up fuse	125 A gG								
Short circuit strength - with back-up fuse acc. to the applicable rules									
IEC/EN 60947-3	12.5 kA	12.5 kA	12.5 kA	12.5 kA	12.5 kA	12.5 kA	12.5 kA	10 kA	10 kA
Endurance									
electrical components operation cycles	≥3.000	≥3.000	≥3.000	≥3.000	≥3.000	≥3.000	≥3.000	≥3.000	≥2.000
mechanical components operation cycles	≥16.000	≥16.000	≥16.000	≥16.000	≥16.000	≥16.000	≥16.000	≥16.000	≥14.000
Mechanical									
Frame size	45 mm								
Device height	80 mm								
Device width	17.5mm/pole								
Mounting	quick fastening with 2 lock-in positions on DIN rail IEC/EN 60715								
Degree of protection, built-in	IP40								
Terminal protection	finger and hand touch safe according to BGV A3								
Terminals	open mouthed/lift terminals								
Terminal capacity	2.5 - 50 mm ²								
Busbar thickness	0.8 - 2 mm								
Fastening torque of terminal screws	2.5 - 5 Nm								
Function	irrespective of the position of installation								

Connection diagram

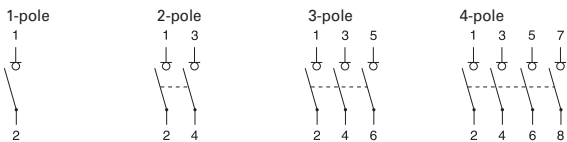

Dimensions (mm)

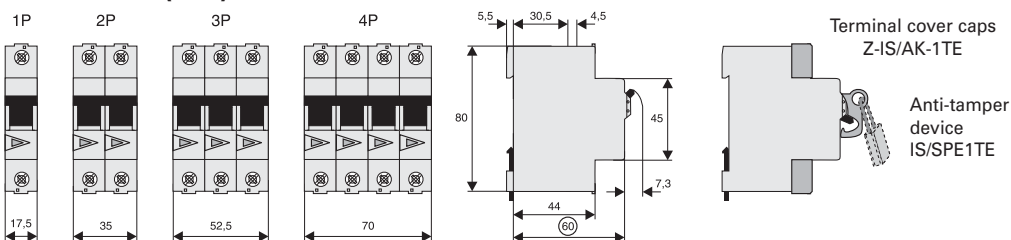

Busbar System xEffect BB-EV

SG13113

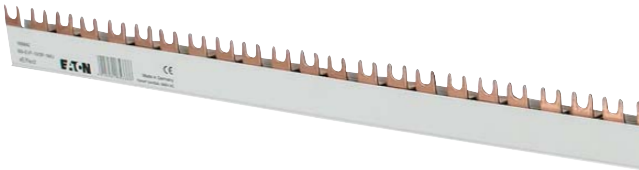

Busbar System xEffect is the modular design system for busbars. xEffect busbars are available as yard goods with 1, 2 or 3 poles. Now, there is a special feature: each bar can easily be extended by one-pole bar as you like. The additional pole can be added completely without tools by easy clamping technique. The lugs or forks in the xEffect bars - available in 10 and 16 mm² and all common distances - can be broken out at a predetermined breaking point. There is actually no more flexibility available.

Busbar System xEffect saves time and material

The yard good can be cut with a saw of course. However, there is no need neither for deburring nor for cutting the conductor. Just cut to the required dimension and close with the fitting end cap -ready! The end caps have also breakable edges, which enable further connecting of the Busbar System xEffect. By overlapping assembly, doubling the cross section can be achieved.

Busbar System xEffect in use

Busbar System xEffect is especially well suited for solving flexible busbar applications rack-mounted models in series. Fork-pin combinations for 1+N-applications can be realized by individual combinations - for this also the one-pole version with blue isolation is available besides the one with grey isolation. Even different cross sections can be combined in this case.

Accessories, such as feeder terminals and self adhesive phase marking labels will complete the comfortable total package. Existing contact prevention caps can be used.

Busbar System xEffect at a glance:

- Yard goods can be cut
- No cutting back of copper required
- No deburring required
- Almost no waste during cutting
- End caps available with 1- to 4-poles, end caps can be broken out for further extensions
- 4-pole end cap molded in pairs (left and right)
- Overlapping rail extension possible
- Rails can be extended on demand by 1-pole rails (plug-in technology)
- All step distances
- 10 and 16 mm²
- Fork and stud
- Lugs can be broken out at any predetermined breaking point
- Self adhesive phase indication labels available
- Contact preventing caps (ZV-BS-G) can be used
- Simple, flexible handling
- All assembly requirements can be covered by the Busbar System xEffect
- Low storage space requirements due to modular system
- Less time consuming (no deburring, no cutting back)
- Individual and self configurable
- Fork-pin combination for 1+N application possible, feeding through rail (terminal clamp) not possible.
- Protected technology

Description	Step Distance (mm)	Cu-factor	Type Designation	Article No.	Units per package
-------------	--------------------	-----------	------------------	-------------	-------------------

xEffect busbar 1m 10mm², 16mm² (Fork) BB-EVF

for MCBs, RCCBs, RCBOs, SPDs

- Delivered without end caps

SG13113



SG13413

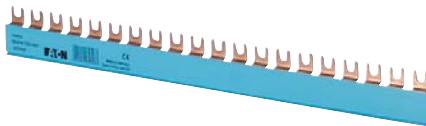

10 mm², Rated Current 63 A

1-phase	17.8	0.22	BB-EVF-10/1P-1MU	168826	10
	27	0.24	BB-EVF-10/1P-1,5MU	168830	10
	36	0.24	BB-EVF-10/1P-2MU	168834	10
2-phase	17.8	0.31	BB-EVF-10/2P-1MU	168838	10
	27	0.36	BB-EVF-10/2P-1,5MU	168840	10
3-phase	17.8	0.46	BB-EVF-10/3P-1MU	168842	10
	27	0.58	BB-EVF-10/3P-1,5MU	168844	10
	36	0.56	BB-EVF-10/3P-2MU	168850	10
3-phase + AUX	3x17.5+1x9	0.58	BB-EVF-10/3P-1MU/AUX	168846	10
	3x17.5+2x9	0.57	BB-EVF-10/3P-1MU/2AUX	168848	10
Neutral	17.8	0.22	BB-EVF-10/N-1MU	168828	10
	27	0.24	BB-EVF-10/N-1,5MU	168832	10
	36	0.24	BB-EVF-10/N-2MU	168836	10

SG13213



SG13613

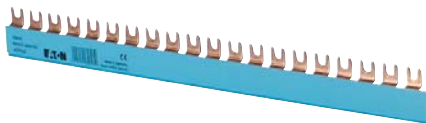

16 mm², Rated Current 80 A

1-phase	17.8	0.33	BB-EVF-16/1P-1MU	168827	10
	27	0.36	BB-EVF-16/1P-1,5MU	168831	10
	36	0.32	BB-EVF-16/1P-2MU	168835	10
2-phase	17.8	0.46	BB-EVF-16/2P-1MU	168839	10
	27	0.54	BB-EVF-16/2P-1,5MU	168841	10
3-phase	17.8	0.69	BB-EVF-16/3P-1MU	168843	10
	27	0.87	BB-EVF-16/3P-1,5MU	168845	10
	36	0.84	BB-EVF-16/3P-2MU	168851	10
3-phase + AUX	3x17.5+1x9	0.87	BB-EVF-16/3P-1MU/AUX	168847	10
	3x17.5+2x9	0.86	BB-EVF-16/3P-1MU/2AUX	168849	10
Neutral	17.8	0.33	BB-EVF-16/N-1MU	168829	10
	27	0.36	BB-EVF-16/N-1,5MU	168833	10
	36	0.32	BB-EVF-16/N-2MU	168837	10

Description	Step Distance (mm)	Cu-factor	Type Designation	Article No.	Units per package
-------------	--------------------	-----------	------------------	-------------	-------------------

xEffect busbar 1m 10mm², 16mm² (Pin) BB-EVP

for MCBs, RCCBs, RCBOs, SPDs

- Delivered without end caps

SG13013



10 mm², Rated Current 63 A

1-phase	17.8	0.22	BB-EVP-10/1P-1MU	168852	10
	27	0.24	BB-EVP-10/1P-1,5MU	168856	10
	36	0.24	BB-EVP-10/1P-2MU	168860	10
2-phase	17.8	0.31	BB-EVP-10/2P-1MU	168864	10
	27	0.36	BB-EVP-10/2P-1,5MU	168866	10
3-phase	17.8	0.46	BB-EVP-10/3P-1MU	168868	10
	27	0.58	BB-EVP-10/3P-1,5MU	168870	10
3-phase + AUX	3x17.5+1x9	0.58	BB-EVP-10/3P-1MU/AUX	168872	10
	3x17.5+2x9	0.57	BB-EVP-10/3P-1MU/2AUX	168874	10
Neutral	17.8	0.22	BB-EVP-10/N-1MU	168854	10
	27	0.24	BB-EVP-10/N-1,5MU	168858	10
	36	0.24	BB-EVP-10/N-2MU	168862	10

SG13513

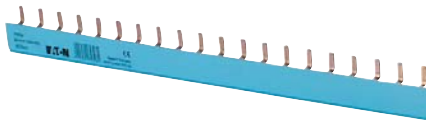

SG12913



16 mm², Rated Current 80 A

1-phase	17.8	0.33	BB-EVP-16/1P-1MU	168853	10
	27	0.36	BB-EVP-16/1P-1,5MU	168857	10
	36	0.32	BB-EVP-16/1P-2MU	168861	10
2-phase	17.8	0.46	BB-EVP-16/2P-1MU	168865	10
	27	0.54	BB-EVP-16/2P-1,5MU	168867	10
3-phase	17.8	0.69	BB-EVP-16/3P-1MU	168869	10
	27	0.87	BB-EVP-16/3P-1,5MU	168871	10
3-phase + AUX	3x17.5+1x9	0.87	BB-EVP-16/3P-1MU/AUX	168873	10
	3x17.5+2x9	0.86	BB-EVP-16/3P-1MU/2AUX	168875	10
Neutral	17.8	0.33	BB-EVP-16/N-1MU	168855	10
	27	0.36	BB-EVP-16/N-1,5MU	168859	10
	36	0.32	BB-EVP-16/N-2 MU	168863	10

SG13313

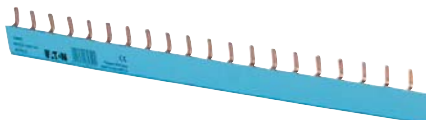

Description	Cu-factor	Type Designation	Article No.	Units per package
-------------	-----------	------------------	-------------	-------------------

Accessories

End caps BB-EV-EC

wa_sg05612



1-phase	-	BB-EV-EC/1P	168878	40
2+3-phase	-	BB-EV-EC/2-3P	168823	40
4-phase	-	BB-EV-EC/4P	168824	20
Neutral	-	BB-EV-EC/N	168879	20

Terminal BB-EV-TE/35

wa_sg05312



	0.04	BB-EV-TE/35	168825	3
--	------	-------------	--------	---

Sticker phase sequence

SG08713



	-	BB-S-PS	169831	5
--	---	---------	--------	---

Busbar Tag Shrouds ZV-BS-G

SG05705



	-	ZV-BS-G	104903	10/600
--	---	---------	--------	--------

Technical Data

BB-EV.

General

Heat deflection temperature	≥80°C UL94 V0
Standards	EN 60947-1:2007 / IEC 60947-1:2007 / IEC 60999:2000
Climate stability	according to DIN EN 60068
Insulation coordination	Overvoltage category III / Degree of pollution 2

Electrical

Impulse voltage strenght	≥4.5 kV
Min. air distance	>5.5 mm
Min. creeping distance	>5 mm
Max. operating voltage	690 V AC/DC 1,000 V DC 1-pole only

Max. current I_g /Phase	
10 mm ²	63 A
16 mm ²	80 A

Protection class	IP20
Short circuit rating I_{CC}	25kA - NH3 355A gC500V JM

Dielectric strenght	PC - ABS >32 kV / mm
---------------------	----------------------

Assembly instruction:

Cutting

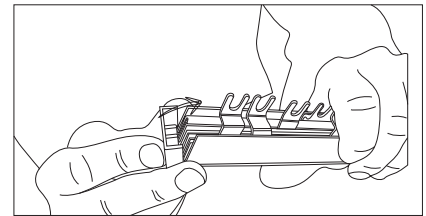
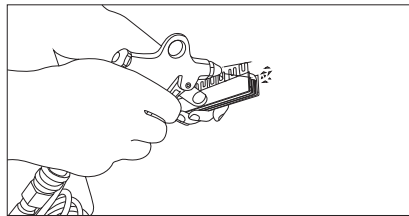
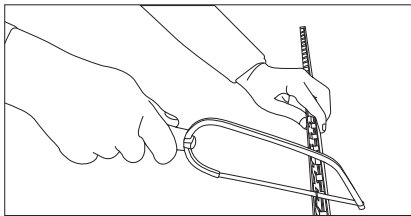

Mounting of an extension busbar

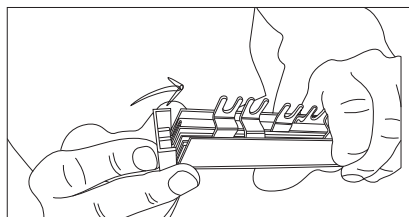
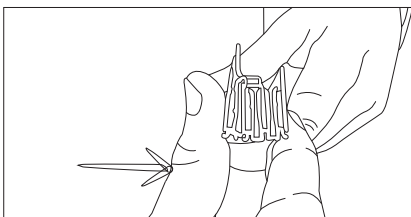
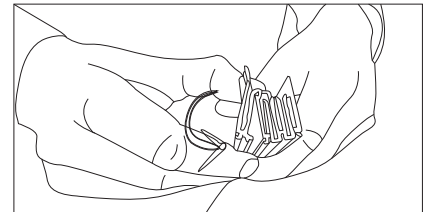
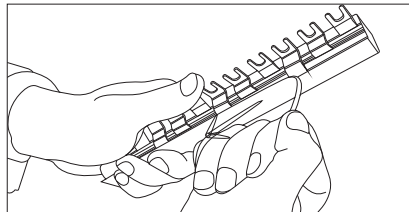
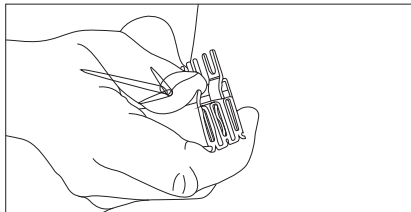

Overlapping mounting or further connection, resp.

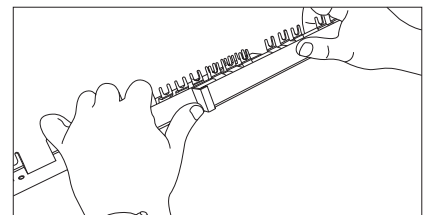
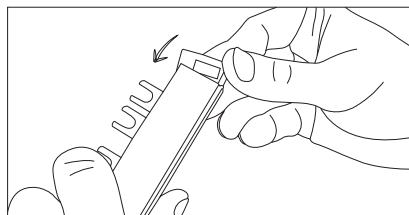
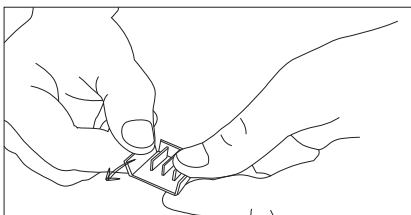

Bracking out of connection lugs

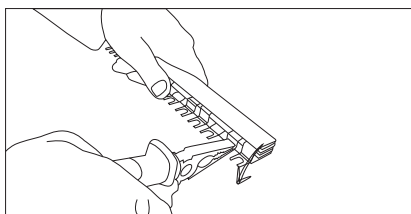

Sticking on phase marking

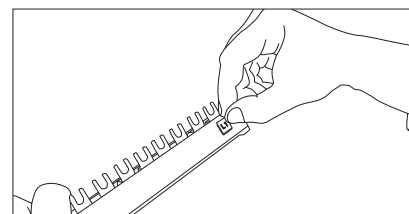

Busbar UL489 Z-BB/UL

SG13713



- For MCB FAZ-NA/RT
- Sliceable
- 18 and 25 mm²
- Pin busbar
- Accessories available:
 - End cap
 - Terminal
 - Busbar tag shrouds
- Length 1 m

Description	Step Distance (mm)	Cu-factor	Type Designation	Article No.	Units per package
-------------	--------------------	-----------	------------------	-------------	-------------------

Busbar UL489 sliceable 1m 18mm², 25mm² (Pin), Z-BB/UL

for FAZ-NA/RT

- Delivered without end caps

SG13713



18 mm², Rated Current 80 A

1-phase	17.6	0.39	Z-BB/UL18/1P1MU/57	171128	10
1-phase + AUX	26.4	0.378	Z-BB/UL18/1P1MU+AUX/37	171134	10
2x 1-phase + AUX	26.4	0.56	Z-BB/UL18/2X1P1MU+AUX/38	171142	10
3x 1-phase + AUX	26.4	0.945	Z-BB/UL18/3X1P1MU+AUX/39	171140	10
2-phase	17.6	0.625	Z-BB/UL18/2P1MU/56	171129	10
2-phase + AUX	17.6 + 26.4	0.625	Z-BB/UL18/2P1MU+AUX/46	171135	10
3-phase	17.6	0.95	Z-BB/UL18/3P1MU/57	171130	10
3-phase + AUX	2x 17.6 + 26.4	0.93	Z-BB/UL18/3P1MU+AUX/48	171136	10

SG14213



25 mm², Rated Current 100 A

1-phase	17.6	0.535	Z-BB/UL25/1P1MU/57	171131	10
1-phase + AUX	26.4	0.745	Z-BB/UL25/1P1MU+AUX/37	171137	10
2x 1-phase + AUX	26.4	0.78	Z-BB/UL25/2X1P1MU+AUX/38	171143	10
3x 1-phase + AUX	26.4	1.315	Z-BB/UL25/3X1P1MU+AUX/39	171141	10
2-phase	17.6	0.888	Z-BB/UL25/2P1MU/56	171132	10
2-phase + AUX	17.6 + 26.4	0.87	Z-BB/UL25/2P1MU+AUX/46	171138	10
3-phase	17.6	1.31	Z-BB/UL25/3P1MU/57	171133	10
3-phase + AUX	2x 17.6 + 26.4	1.28	Z-BB/UL25/3P1MU+AUX/48	171139	10

Description	Cu-factor	Type Designation	Article No.	Units per package
-------------	-----------	------------------	-------------	-------------------

Accessories

End cap Z-ECUL

SG02514



	-	Z-ECUL	171145	10
--	---	--------	--------	----

Terminal Z-TEUL35

SG03014



	0,038	Z-TEUL35	171144	10
--	-------	----------	--------	----









Busbar Tag Shrouds Z-FPUL

SG08613



	-	Z-FPUL	171146	10
--	---	--------	--------	----

Description of the Busbar UL489, Z-BB/UL for FAZ-NA, -RT

									
Z-BB/UL18/1P1MU/57	171128	57	-	-	-	-	-	-	-
Z-BB/UL18/2P1MU/56	171129	-	56	-	-	-	-	-	-
Z-BB/UL18/3P1MU/57	171130	-	-	57	-	-	-	-	-
Z-BB/UL25/1P1MU/57	171131	57	-	-	-	-	-	-	-
Z-BB/UL25/2P1MU/56	171132	-	56	-	-	-	-	-	-
Z-BB/UL25/3P1MU/57	171133	-	-	57	-	-	-	-	-
Z-BB/UL18/1P1MU+AUX/37	171134	-	-	-	37	-	-	-	-
Z-BB/UL18/2P1MU+AUX/46	171135	-	-	-	-	-	-	46	-
Z-BB/UL18/3P1MU+AUX/48	171136	-	-	-	-	-	-	-	48
Z-BB/UL25/1P1MU+AUX/37	171137	-	-	-	37	-	-	-	-
Z-BB/UL25/2P1MU+AUX/46	171138	-	-	-	-	-	-	46	-
Z-BB/UL25/3P1MU+AUX/48	171139	-	-	-	-	-	-	-	48
Z-BB/UL18/3X1MU+AUX/39	171140	-	-	-	-	-	39	-	-
Z-BB/UL25/3X1MU+AUX/39	171141	-	-	-	-	-	39	-	-
Z-BB/UL18/2X1MU+AUX/38	171142	-	-	-	-	38	-	-	-
Z-BB/UL25/2X1MU+AUX/38	171143	-	-	-	-	38	-	-	-
Z-TEUL35	171144	-	-	-	-	-	-	-	-
Z-ECUL	171145	-	-	-	-	-	-	-	-
Z-FPUL	171146	-	-	-	-	-	-	-	-

Technical Data

Z-BB/UL	
General	
Heat deflection temperature	>100°C - UL94 V0
Standards	UL489, EN 60947-1, IEC 60947-1:2004
Climate stability	according to DIN EN 60068
Insulation coordination	Overvoltage category III / Degree of pollution 2
Electrical	
Impulse voltage strenght	≥ 10 kV
Min. air distance	≥ 1" ext.
Min. creeping distance	≥ 2" ext.
Max. operating voltage	
1-pole	1,000 V AC/DC
2-, 3-pole	600 V AC/DC
Max. current I _s /Phase	
18 mm ²	80 A
25 mm ²	100 A
Protection class	IP20
Short circuit rating I _{CC}	10 kA
Dielectric strenght	PA66-V0, >35 kV

Mounting example of busbar UL489, Z-BB/UL for FAZ-NA, -RT

Z-BB/UL18/XX
Z-BB/UL25/XX

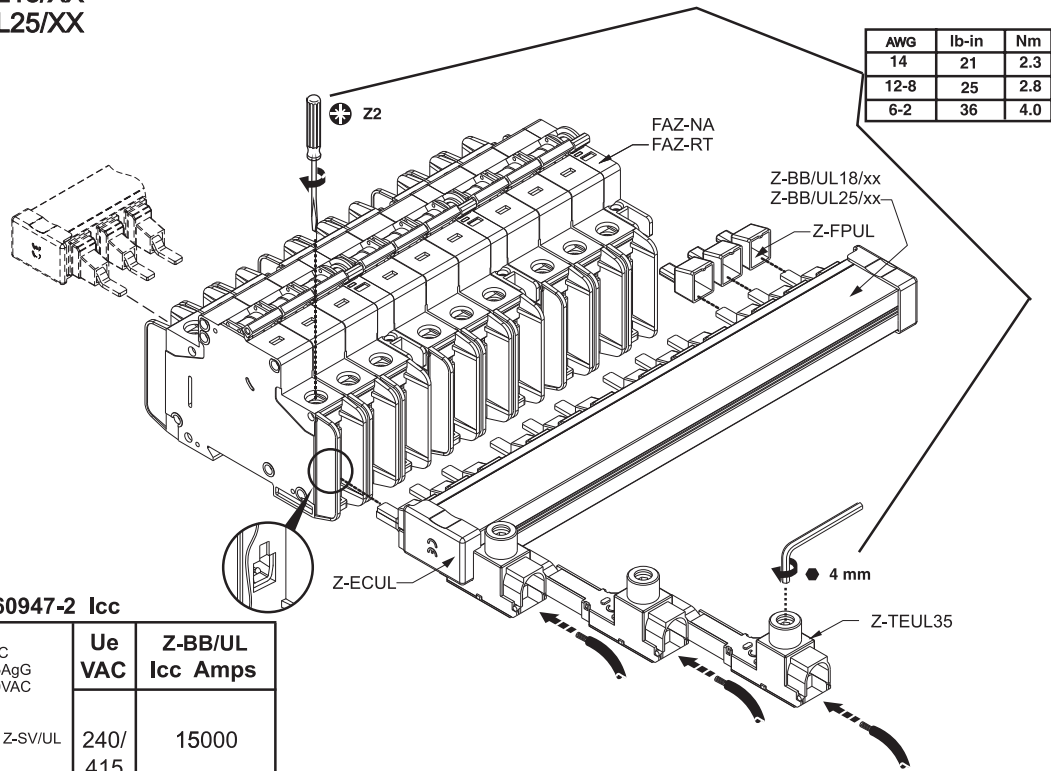

IEC/EN 60947-2 Icc

Ue HRC 315AgG 500VAC	Ue VAC	Z-BB/UL Icc Amps
Z-SV/UL	240/ 415	15000

UL SCCR

Ue Z-SV/UL	FAZ-NA FAZ-RT In Amps	Ue VAC	Z-BB/UL SCCR RMS Sym Amps
FAZ-NA FAZ-RT	0.5-32	480Y/ 277	10000
	35-40	240	10000

Busbar UL508 BB/UL

SG01914



- For MCB FAZ
- Sliceable
- 18 and 25 mm²
- Pin busbar
- Accessories available:
 - End caps
 - Terminals
 - Busbar tag shrouds
- Length 1 m

Description	Step Distance (mm)	Cu-factor	Type Designation	Article No.	Units per package
-------------	--------------------	-----------	------------------	-------------	-------------------

Busbar UL508 sliceable 1m 18mm², 25mm² (Pin), BB/UL

for FAZ

- Delivered without end caps

SG01914



18 mm², Rated Current 80 A

1-phase	17.8	0.33	BB-UL-18/1P-1M/57	121981	10
2-phase	17.8	0.508	BB-UL-18/2P-2M/56	121982	10
3-phase	17.8	0.8	BB-UL-18/3P-3M/57	121983	10
1-phase + AUX	27	0.33	BB-UL-18/1P-1,5M/37	121984	10
2-phase + AUX	17.8 + 26.7	0.52	BB-UL-18/2P+AS-2,5M/46	121987	10
3-phase + AUX	2x 17.8 + 26.7	0.8	BB-UL-18/3P+AS-3,5M/48	121988	10

SG01814



25 mm², Rated Current 100 A

1-phase	17.8	0.45	BB-UL-25/1P-1M/57	121989	10
2-phase	17.8	0.68	BB-UL-25/2P-2M/56	121990	10
3-phase	17.8	1.07	BB-UL-25/3P-3M/57	121991	10
1-phase + AUX	27	0.45	BB-UL-25/1P-1,5M/37	121992	10
2-phase + AUX	17.8 + 26.7	0.69	BB-UL-25/2P+AS-2,5M/46	121995	10
3-phase + AUX	2x 17.8 + 26.7	1.03	BB-UL-25/3P+AS-3,5M/48	121996	10

Description	Cu-factor	Type Designation	Article No.	Units per package
-------------	-----------	------------------	-------------	-------------------

Accessories

End caps BB-UL-EC

SG02114



1-phasing	-	BB-UL-EC/1	122000	10
3-phasing	-	BB-UL-EC/3	122001	10

Terminals BB-UL-TE

SG00113



6 - 35mm ² (single and multi wire)	0,035	BB-UL-TEP/35	121997	10
6 - 50mm ²	0,038	BB-UL-TEPA/35	169823	10
6 - 50mm ² (single and multi wire)	0,038	BB-UL-TE/50	121998	10



Busbar Tag Shrouds BB-IP/5

SG05705

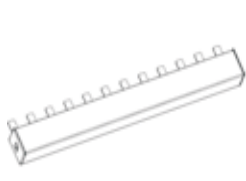

for 5 pins	-	BB-IP/5	121999	10
------------	---	---------	--------	----

Description of the Busbar UL508, BB/UL for FAZ

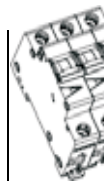
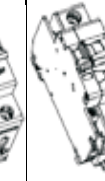
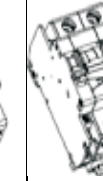
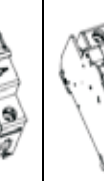

Article No.							
121981	BB-UL-18/1P-1M/57	57	-	-	-	-	-
121982	BB-UL-18/2P-2M/56	-	28	-	-	-	-
121983	BB-UL-18/3P-3M/57	-	-	19	-	-	-
121984	BB-UL-18/1P-1,5M/37	-	-	-	37	-	-
121987	BB-UL-18/2P+AS-2,5M/46	-	-	-	-	23	-
121988	BB-UL-18/3P+AS-3,5M/48	-	-	-	-	-	16
121989	BB-UL-25/1P-1M/57	57	-	-	-	-	-
121990	BB-UL-25/2P-2M/56	-	28	-	-	-	-
121991	BB-UL-25/3P-3M/57	-	-	19	-	-	-
121992	BB-UL-25/1P-1,5M/37	-	-	-	37	-	-
121995	BB-UL-25/2P+AS-2,5M/46	-	-	-	-	23	-
121996	BB-UL-25/3P+AS-3,5M/48	-	-	-	-	-	16
121997	BB-UL-TEP/35	-	-	-	-	-	-
169823	BB-UL-TEPA/35	-	-	-	-	-	-
121998	BB-UL-TE/50	-	-	-	-	-	-
121999	BB-IP/5	-	-	-	-	-	-
122000	BB-UL-EC/1	-	-	-	-	-	-
122001	BB-UL-EC/3	-	-	-	-	-	-

Technical Data

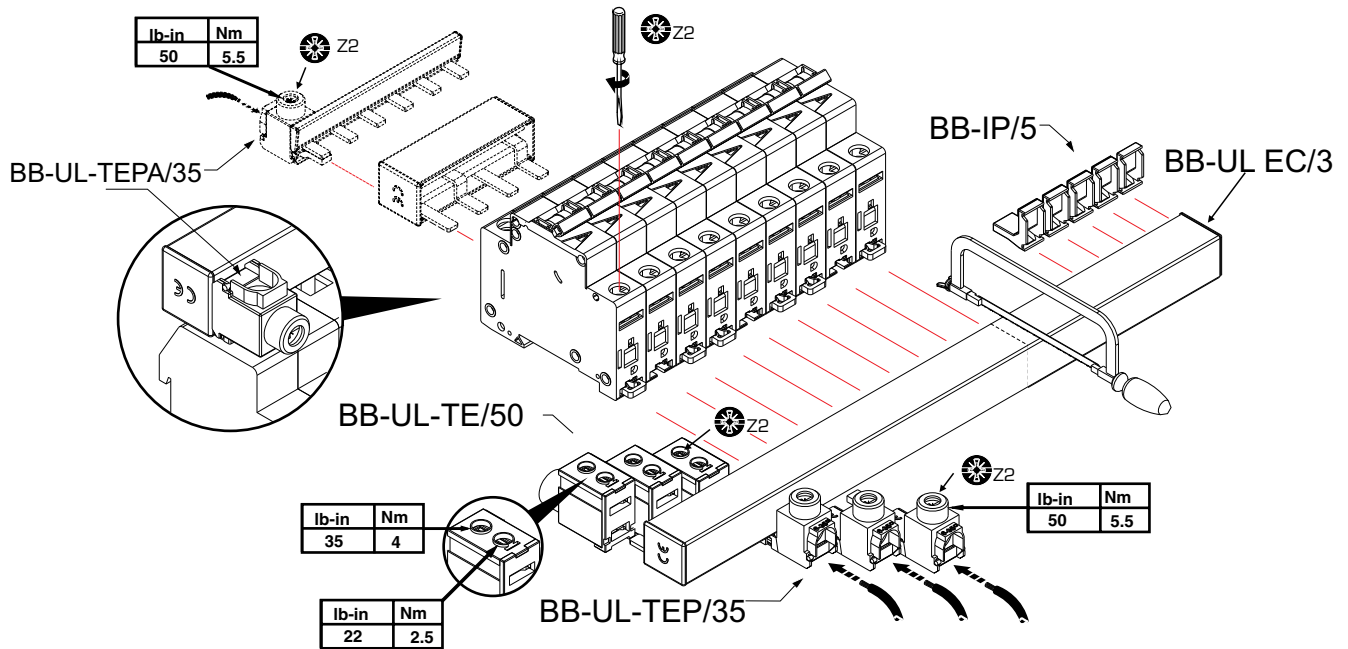

Z-BB/UL	
General	
Heat deflection temperature	125°C - UL94 V0
Standards	DIN EN 60947-2, VDE 0660 - 101 = IEC 60947-2, IEC 60999:2000, UL508, UL486A, CSA C22.2
Climate stability	according to DIN EN 60068
Insulation coordination	Overvoltage category III / Degree of pollution 2
Electrical	
Impulse voltage strenght	≥9.5 kV
Min. air distance	>9.5 mm
Min. creeping distance	>12.7 mm
Max. operating voltage	
1-pole	1,000 V AC/DC
2-, 3-pole	IEC/EN 690 V AC/DC 600 V AC/DC UL Fuse 480 V AC/DC UL-SP
Terminals	1, 000 V AC/DC
Max. current I _g /Phase	
18 mm ²	80 A (feed in the center: 160 A)
25 mm ²	100 A (feed in the center: 200 A)
Protection class	IP20
Short circuit rating	10kA 3 cycles@480V / 100 kA Fuse Class J 175A@18mm ² - 200A@25mm ²
Dielectric strenght	>32 kV/mm

Mounting example of busbar UL508, BB/UL for FAZ

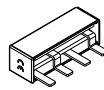

BB-UL-TE/50		
	UL508	EN/IEC 60947-2
U_e	480 V AC	240/690V AC
f	50/60 Hz	50/60 Hz
I_e	115 A @ 40°C	160 A @ 30°C
	#1-14 AWG 60/75°C Cu	1.5 – 50 mm ² Cu
	0.56 in	14 mm

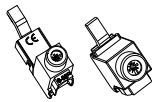
BB-UL		
	UL508	EN/IEC 60947-2
U_e	480 V AC	690V AC
f	50/60 Hz	
I_{pk}	10kA	15kA
I_e	18mm ²	25mm ²
Infeed at the start of the busbar	80A @ 40 °C	100A @ 30°C
Infeed at the center of the busbar	160A @ 40°C	200A @ 30°C

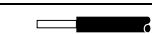
BB-UL-TEP/35 / BB-UL-TEPA/35		
	UL508	EN/IEC 60947-2
U_e	480 V AC	240/690V AC
f	50/60 Hz	50/60 Hz
I_e	115 A @ 40°C	80 A @ 30°C
	#2-14 AWG 60/75°C Cu	2.5 – 35 mm ² Cu
	0.56 in	14 mm

*-UL508 SHORT CIRCUIT RATINGS

-SUITABLE FOR USE ON A CIRCUIT CAPABLE OF DELIVERING NOT MORE THAN 10,000 RMS SYMETRICAL AMPERES, 600 VOLTS MAXIMUM.

-SUITABLE FOR USE ON A CIRCUIT CAPABLE OF DELIVERING NOT MORE THAN 100,000 RMS SYMETRICAL AMPERES, 600 VOLTS MAXIMUM WHEN PROTECTED BY A CLASS J FUSE RATED 175A.

Busbar UL489 Z-SV/UL16

wa_sg03511



- For MCB FAZ-NA/RT
- 16 mm²
- Pin busbar
- Accessories available:
 - Terminals
 - Busbar tag shrouds
- Several length

Description	Step Distance (mm)	Cu-factor	Type Designation	Article No.	Units per package
-------------	--------------------	-----------	------------------	-------------	-------------------

Busbar UL489 16mm² (Pin), Z-SV/UL16

for FAZ-NA/RT, not sliceable!!

- Delivered with end caps

wa_sg03511



16 mm², Rated Current 80 A

1-phase, 6MU	17.6	0.035	Z-SV/UL-16/1P-1MU/6	104892	10
1-phase, 12MU	17.6	0.07	Z-SV/UL-16/1P-1MU/12	104893	10
1-phase, 18MU	17.6	0.105	Z-SV/UL-16/1P-1MU/18	104894	10
2-phase, 6MU	17.6	0.07	Z-SV/UL-16/2P-2MU/6	104895	10
2-phase, 12MU	17.6	0.14	Z-SV/UL-16/2P-2MU/12	104896	10
2-phase, 18MU	17.6	0.21	Z-SV/UL-16/2P-2MU/18	104897	10
3-phase, 6MU	17.6	0.14	Z-SV/UL-16/3P-3MU/6	104898	10
3-phase, 12MU	17.6	0.221	Z-SV/UL-16/3P-3MU/12	104899	10
3-phase, 18MU	17.6	0.332	Z-SV/UL-16/3P-3MU/18	104900	10

Description	Cu-factor	Type Designation	Article No.	Units per package
-------------	-----------	------------------	-------------	-------------------

Accessories

Terminals Z-TEUL35

SG07506



2.5 - 35mm ²	0.035	Z-EK/35/UL	104901	3
1.5 - 50mm ²	0.038	Z-EB/50/UL	104902	3

Busbar Tag Shrouds Z-FPUL

SG07706



for 3 pins	-	ZV-BS-UL	104904	10
------------	---	----------	--------	----

Description of the Busbar UL489, Z-SV/UL-16 for FAZ-NA/RT

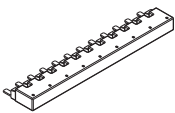
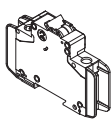
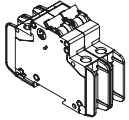
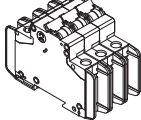
Article No.				
104892	Z-SV/UL-16/1P-1TE/6	6	-	-
104893	Z-SV/UL-16/1P-1TE/12	12	-	-
104894	Z-SV/UL-16/1P-1TE/18	18	-	-
104895	Z-SV/UL-16/2P-2TE/6	-	3	-
104896	Z-SV/UL-16/2P-2TE/12	-	6	-
104897	Z-SV/UL-16/2P-2TE/18	-	9	-
104898	Z-SV/UL-16/3P-3TE/6	-	-	2
104899	Z-SV/UL-16/3P-3TE/12	-	-	4
104900	Z-SV/UL-16/3P-3TE/18	-	-	6
104901	Z-EK/35/UL	-	-	-
104902	Z-EB/50/UL	-	-	-
104904	ZV-BS-UL	-	-	-

Technical Data

Z-SV/UL16	
General	
Heat deflection temperature	125°C - UL94 V0
Standards	
Busbar	UL489, DIN EN 60947-1, VDE 0660 part 100 = IEC 60947-1:2004, IEC 60947-2:2003
Terminal	IEC 60999:2000, UL489, UL486A, CSA C22.2
Climate stability	according to DIN EN 60068
Insulation coordination	Overvoltage category III / Degree of pollution 2
Electrical	
Impulse voltage strenght	≥9.5 kV (1kV / mmLS)
Min. air distance	>9.5mm/25.4mm (intern/external)
Min. creeping distance	>12.7mm/50.8mm (intern/external)
Max. operating voltage	
1-, 3-phase	690 V IEC 480Y/277V & 240V AC
Terminals	1,000 V AC/DC
Max. current I _g /Phase	80 A
Protection class	IP20
Short circuit rating	15kA with NH3 355 A gL 500V JM / 7.5kA 3 cycles @ 600V
Dielectric strenght	>30 kV/mm

Mounting example of busbar UL489, Z-SV/UL-16 for FAZ-NA, -RT



- ⚠ ATTENTION:** Maximum of 3 commoning links allowed. Any combination of same pole configuration.
- ATTENTION:** 3 liaisons communes autorisées au maximum. Toute combinaison de configurations de polarité identiques.
- ACHTUNG:** Maximal 3 Schienenblöcke. Beliebige Kombination gleichpoliger Konfigurationen.
- ATTENZIONE:** Sono consentiti al massimo 3 pettini di collegamento in qualsiasi combinazione della stessa configurazione di poli.
- ATENCIÓN:** Se permite un máximo de 3 enlaces comunes. Cualquier combinación del mismo tipo de configuración de polo



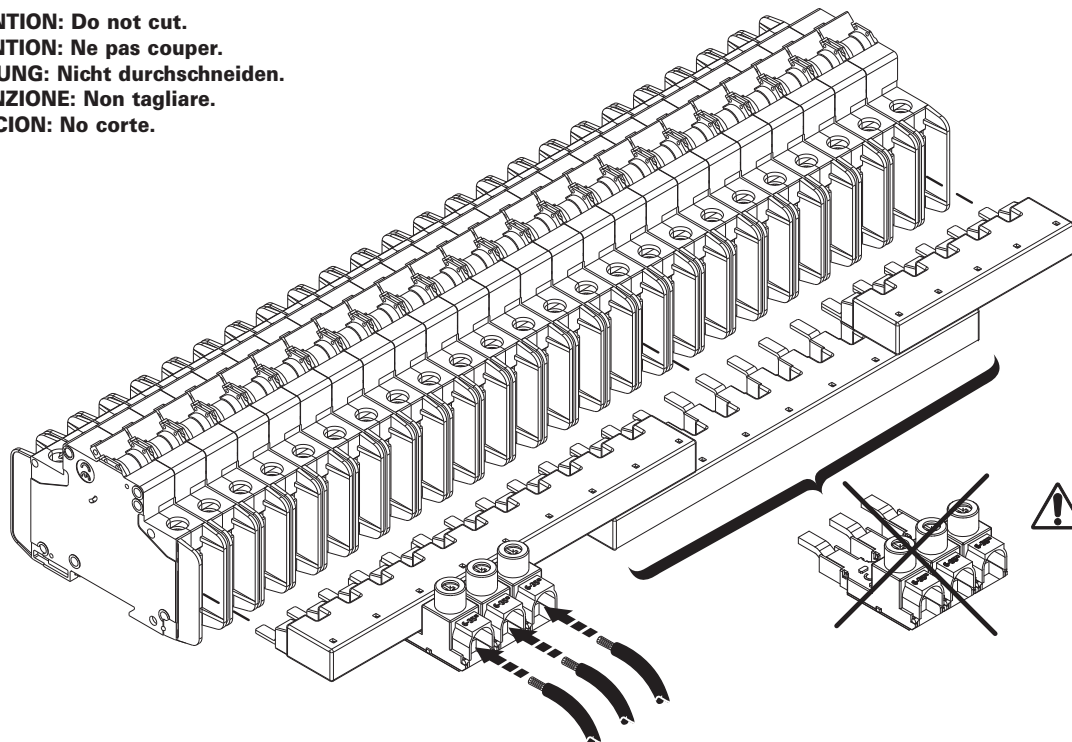

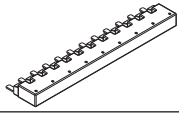
- ATTENTION: Do not cut.**
- ATTENTION: Ne pas couper.**
- ACHTUNG: Nicht durchschneiden.**
- ATTENZIONE: Non tagliare.**
- ATENCIÓN: No corte.**

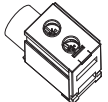

	UL489	EN/IEC 00947-2	
U_e	480 V AC	96 V DC	240/415 V AC
f	50/60 Hz	-----	50/60 Hz
U_{imp}	-----		9.5 kV
I_e	80 A @ 40°C		80 A @ 30°C
Cross section	-----		16 mm ²

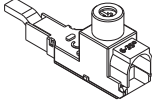
	UL489	EN/IEC 00947-2	
U_e	480 V AC	96 V DC	240/415 V AC
f	50/60 Hz	-----	50/60 Hz
U_{imp}	-----		9.5 kV
	#1-14 AWG 60/75°C Cu	1.5-50 mm ² Cu	
	0.56 in	14 mm	

	UL489	EN/IEC 00947-2	
U_e	480 V AC	96 V DC	240/415 V AC
f	50/60 Hz	-----	50/60 Hz
U_{imp}	-----		9.5 kV
I_e	80 A @ 40°C		80 A @ 30°C
	#2-14 AWG 60/75°C Cu	2.5-35 mm ² Cu	
	0.56 in	14 mm	

Mounting example of busbar UL489, Z-SV/UL-16 for FAZ-NA, -RT

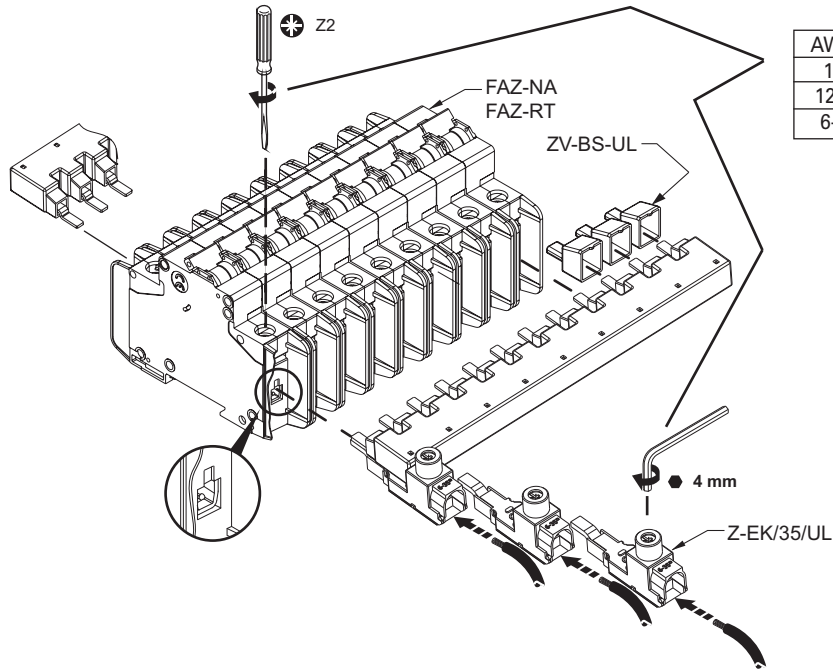

AWG	lb-in	Nm
14	21	2.3
12-8	25	2.8
6-2	36	4.0

IEC/EN 60947-2 Icc

	Ue VAC	Z-SV/UL Icc Amps
	240/ 415	15000

UL SCCR

	FAZ-NA FAZ-RT In Amps	Ue VAC	Z-SV/UL SCCR RMS Sym Amps
	0.5-32	480Y/ 277	10000
35-40	240	10000	

Accessories for RCDs, MCBs, Combined RCD/MCB Devices

SG60811



- SWD Auxiliary Module
- Auxiliary Switch
- RCD-Tripping Module
- Shunt Trip Release
- Undervoltage Release
- Remote Control and Automatic Switching Device
- Switching Interlocks
- Terminal Covers

SG60811



Auxiliary SWD Module for MCBs, RCCBs and RCBOs

SG00114



sg01515



	Type Designation	Article No.	Units per package
SWD Module	MCB-HK-SWD	177175	1
Spare End Cap	SWD4-OS	178150	10

Specifications | Auxiliary SWD Module

Description

- Auxiliary module for the connection of an MCB, RCCB or RCBO to the SWD line
- Connection to an RCCB on the left side and to an MCB or RCBO on the right side
- Communication of on/off and trip status, trip indicator
- SWD connection on the top and bottom possible
- Integrated SWD-bus LED

Technical Data



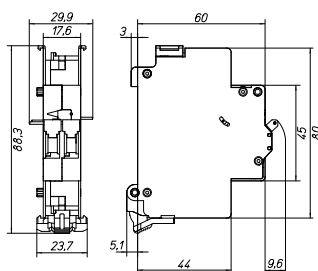

	MCB-HK-SWD
Pollution degree:	2
Degree of protection:	IP20
Power supply:	via SWD line
Operation temperature:	-25 to +40°C
Dimensions:	W x H x D = 17.5 x 88.3 x 77.3 mm

Dimensions (mm)



Auxiliary Switch Z-HK, Z-AHK, Z-HD; Tripping Signal Switch Z-NHK

Design: for screwing

	For Protective Device / Function	Type Designation	Article No.	Units per package
 <p>SG34812</p>	RCCB / 1NO+1NC	Z-HK	248432	4/120
 <p>SG60911</p>	MCB, RCBO (1+N, 3P, 3+N) / 1NO+1NC	Z-AHK	248433	4/120
 <p>SG61011</p>	MCB, RCBO, RCCB / 2CO	Z-NHK	248434	4/120
 <p>SG34412</p>	RCCB / 1CO+1NC	Z-HD	265620	1

Specifications | Auxiliary Switch Z-HK, Z-AHK; Tripping Signal Switch Z-NHK

Description

- Design according to IEC/EN 60947-5-1, IEC/EN 62019
- Can be mounted subsequently (screws) onto FRCmM, FRCdM
- The specified minimum voltages are per contact.
Take into account particularly in case of series connection!
- **Z-AHK, Z-NHK:** Contact function with relative movement (self-cleaning contacts)
- Contact material and design particularly suitable for extra low voltage
- **Z-NHK:** The function of one of the two change-over contacts can be switched from “auxiliary switch” to “tripping signal switch”
- Tripping signal contact transmits message of electric tripping, not mechanical switch-off
- Test key for contact function “electrical tripping”

Technical Data

	Z-HK	Z-AHK	Z-NHK
Electrical			
Contact function	1NO + 1NC	1NO + 1NC	2CO
Rated voltage	250 V	250 V	250 V
Frequency	50/60 Hz	50/60 Hz	50/60 Hz
Rated current	8 A	4 A	4 A
Rated thermal current	I_{th} 8 A	4 A	4 A
Utilisation category AC13			
Rated operational current	I_e 6A/250V AC 2A/440V AC	3A/250V AC -	3A/250V AC -
Utilisation category AC15			
Rated operational current	I_e -	2A/250V AC	2A/250V AC
Utilisation category DC12			
Rated operational current	I_e -	0,5A/110V DC	0,5A/110V DC
Utilisation category DC13			
Rated operational current	I_e 0,5A/230V DC 2A/110V DC 4A/60V DC	- - -	- - -
Rated insulation voltage	U_i 250 V AC	250 V AC	250 V AC
Minimum operational voltage per contact	U_{min} 24 V AC/DC	5 V DC	5 V DC
Minimum operational current	I_{min} 50 mA AC/DC	10 mA DC	10 mA DC
Rated peak withstand voltage	$U_{imp} (1,2/50\mu)$ 2,5 kV	2,5 kV	2,5 kV
Conditional short circuit current	I_k		
with back-up fuse 6A or FAZ-B4-HS	1 kA	1 kA	1 kA
Max. back-up fuse, overload and short circuit	6 A gL / FAZ-4/..B-HS	4 A gL / FAZ-4/..B-HS	4 A gL / FAZ-4/..B-HS
Mechanical			
Can be mounted from the left onto	RCCB	MCB, RCBO (1+N, 3P, 3+N)	MCB, RCBO
Can be mounted from the right onto	-	-	RCCB
Tripping indicator "electrical tripping"	-	-	blue/white
Frame size	45 mm	45 mm	45 mm
Device height	80 mm	80 mm	80 mm
Device width	8.8 mm (0.5MU)	8.8 mm (0.5MU)	8.8 mm (0.5MU)
Mounting	onto switching device	onto switching device	onto switching device
Degree of protection, built-in	IP40	IP40	IP40
Terminal protection	finger and hand touch safe according to BGV A3, ÖVE-EN 6		
Terminals	lift terminals	lift terminals	lift terminals
Terminal capacity	0.5-2.5 mm ²	0.5-2.5 mm ²	0.5-2.5 mm ²
Terminal screws	M3 (Pozidrive Z0)	M3 (Pozidrive Z0)	M3 (Pozidrive Z0)
Fastening torque of terminal screws	max. 0.8-1.0 Nm	max. 0.8-1.0 Nm	max. 0.8-1.0 Nm

Connection diagram

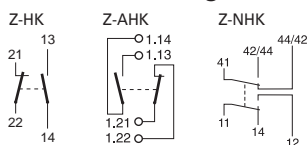

Dimensions (mm)

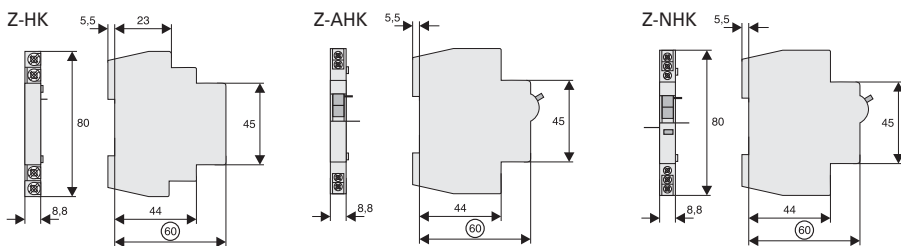

Example: Z-HK+RCCB

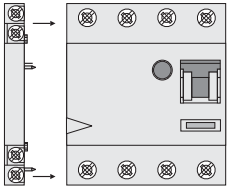

1NO+1NC 24V 50mA min.

Example: Z-AHK+MCB

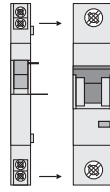

1NO+1NC 5V 10mA min.

Example: Z-NHK+MCB RCCB+Z-NHK

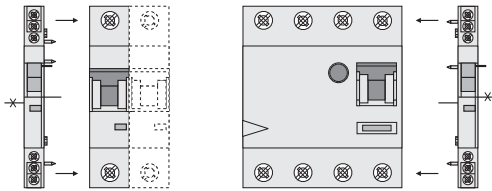

2CO 5V 10mA min.

Specifications | Auxiliary Switch Z-HD

Function Auxiliary Switch Z-HD

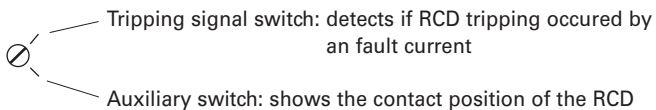

Technical Data

Z-HD	
Electrical	
Subsequent installation to the left onto	FRCmM-125A
Contacts	1CO + 1NC
Load rating	
AC11	6 A / 230 V AC
DC11	1 A / 230 V DC
Mechanical	
Terminal capacity	up to 2.5 mm ²

Connection diagram

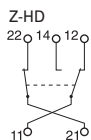

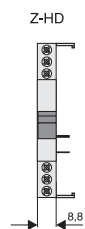

Dimensions (mm)



Auxiliary Switch ZP-AHK, ZP-IHK, ZP-WHK; Tripping Signal Switch ZP-NHK

Design: for snapping

	For Protective Device / Function	Type Designation	Article No.	Units per package
 <p>SG60811</p>	MCB, RCBO / 1NO+1NC	ZP-IHK	286052	4/120
 <p>SG34612</p>	MCB, RCBO / 1CO	ZP-WHK	286053	4/120
 <p>SG34512</p>	MCB, RCBO / 2CO	ZP-NHK	248437	4/120

Specifications | Auxiliary Switch ZP-IHK, ZP-WHK; Tripping Signal Switch ZP-NHK

Description

- Design according to IEC/EN 62019
- No screws required. Can be snapped onto FAZ and FRBmM-1N subsequently
- **ZP-IHK, ZP-WHK:** Can be snapped on additionally 1 time onto itself
- The specified minimum voltages are per contact. Take into account particularly in case of series connection!
- Contact material and design particularly suitable for extra low voltage.
- Contact function with relative movement (self-cleaning contacts)e)
- **ZP-NHK:** The function of one of the two change-over contacts can be switched from "auxiliary switch" to "tripping signal switch"
- Tripping signal contact transmits message of electric tripping, not mechanical switch-off
- **ZP-NHK:** The "Service button" is used to check whether or not the auxiliary switch is correctly wired in the tripping-signal-switch position. Activating the "service button" will mechanically simulate an electrical switch-off, so the mechanism for the electrical switchoff will disengage and can be checked. The main switchgear (MCB or combined MCB/RCD) connected to the ZP-NHK auxiliary switch does not need to trip as well during an inspection through the service button.

Technical Data

	ZP-IHK	ZP-WHK	ZP-NHK
Electrical			
Contact function	1NO + 1NC	1CO	2CO
Rated voltage	250 V	250 V	250 V
Frequency	50/60 Hz	50/60 Hz	50/60 Hz
Rated current	6 A	6 A	4 A
Rated thermal current	I_{th} 6 A	6 A	4 A
Utilisation category AC13			
Rated operational current	I_e 3A/250V AC	3A/250V AC	3A/250V AC
Utilisation category AC15			
Rated operational current	I_e 2A/250V AC	2A/250V AC	2A/250V AC
Utilisation category DC12			
Rated operational current	I_e 0.5A/110V DC	0.5A/110V DC	0.5A/110V DC
Rated insulation voltage	U_i 250 V AC	250 V AC	250 V AC
Minimum operational voltage per contact	U_{min} 5 V DC	5 V DC	5 V DC
Minimum operational current	I_{min} 10 mA DC	10 mA DC	10 mA DC
Rated peak withstand voltage	U_{imp} (1.2/50 μ) 2.5 kV	2.5 kV	2.5 kV
Conditional short circuit current	I_k		
with back-up fuse 6A or PLSM-B4-HS	1 kA	1 kA	1 kA
Max. back-up fuse, overload and short circuit	6 A gL / FAZ-B4-HS	6 A gL / FAZ-B4-HS	6 A gL / FAZ-B4-HS
Mechanical			
Can be mounted from the left onto	MCB, RCBO	MCB, RCBO	MCB, RCBO
Accessories:	ZP-ASA	ZP-ASA	ZP-ASA
Tripping indicator "electrical tripping"	–	–	blue/white
Frame size	45 mm	45 mm	45 mm
Device height	80 mm	80 mm	80 mm
Device width	8.8 mm (0.5MU)	8.8 mm (0.5MU)	8.8 mm (0.5MU)
Degree of protection, built-in	IP40	IP40	IP40
Terminal protection	finger and hand touch safe according to BGV A3, ÖVE-EN 6		
Terminals	lift terminals	lift terminals	lift terminals
Terminal capacity	0.5-2.5 mm ²	0.5-2.5 mm ²	0.5-2.5 mm ²
Terminal screws	M4 (Pozidrive Z2)	M4 (Pozidrive Z2)	M3 (Pozidrive Z0)
Fastening torque of terminal screws	max. 1.2 Nm	max. 1.2 Nm	max. 0.8-1.0 Nm

Connection diagram

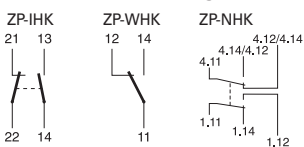

Dimensions (mm)

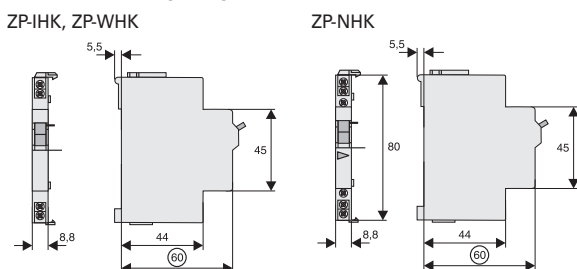

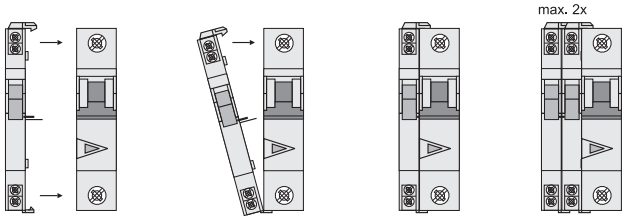

Example: ZP-IHK/(ZP-WHK)+MCB

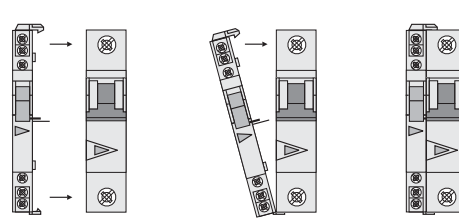

Example: ZP-NHK+MCB



RCCB-Tripping Module Z-.AM

	For Protective Device	Type Designation	Article No.	Units per package
 <p>SG16011</p>	RCCB	Z-FAM	248293	1/60
 <p>SG16211</p>	RCBO	Z-KAM	248294	1/60

Specifications | RCCB Tripping Module Z-FAM, Z-KAM

Description

- For remote switch-off of RCCBs, standard and electronic combined RCD/MCB devices
- Remote switch-off by one or several parallel potential-free contacts, e.g. pushbutton max. rated current 3 A at 250 V, take into account maximum pushbutton voltage
- Remote tripping test by means of remote testing module Z-FW
- Can be mounted subsequently, to be wired according to connection diagram with the respective terminals of the RCCB
- No undesired voltage rise in the consumer system during remote switch-off thanks to integrated breaker contact K1-K2

Technical Data

	Z-FAM	Z-KAM
Electrical		
Rated voltage	230(400) V AC	230(400) V AC
Frequency	50-60 Hz	50-60 Hz
Rated tripping current	$I_{\Delta n}$ 0.01 - 0.3 A	0.01 - 0.3 A
Function	1NO	1NO
Mechanical		
Tripping module for	RCCB	RCBO
Frame size	45 mm	45 mm
Device height	80 mm	80 mm
Device width	8.8 mm (0.5MU)	8.8 mm (0.5MU)
Degree of protection, built-in	IP40	IP40
Terminal capacity	1 - 2x2.5 mm ²	1 - 2x2.5 mm ²
Terminal protection	finger and hand touch safe, according to BGV A3, ÖVE-EN 6	

Connection diagram

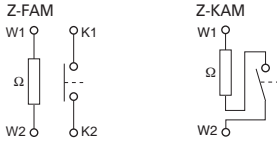

Dimensions (mm)

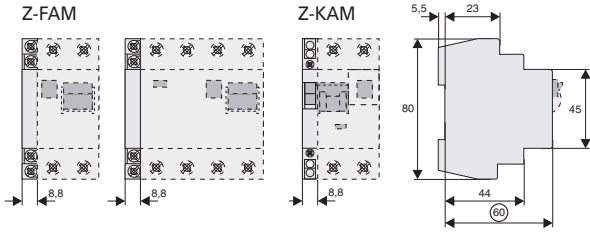

Connection examples Lay lines to the switching devices with double insulation **and** overload protection, e.g. 4A gL or CLS6-4..-HS

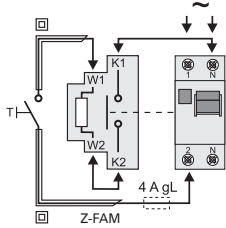

Connection diagram:
RCCB-2p, RCCB feed above

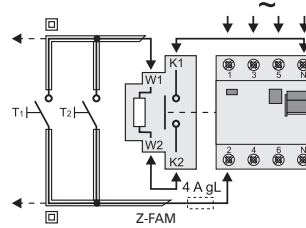

Connection diagram:
RCCB-4p, RCCB feed above

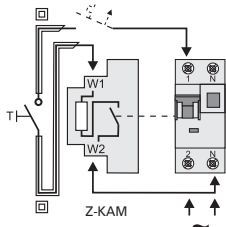

Connection diagram:
RCBO-2p, RCBO feed below

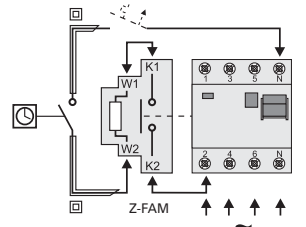

Connection diagram:
RCCB-4p, RCCB feed below

Shunt Trip Release Z-ASA, ZP-ASA

Operational voltage range (V~)	Type Designation	Article No.	Units per package
--------------------------------	------------------	-------------	-------------------

SG00712



To be glued on

12-110	Z-ASA/24	248286	1/60
110-415	Z-ASA/230	248287	1/60

SG00212



To be snapped on

12-110	ZP-ASA/24	248438	1/60
110-415	ZP-ASA/230	248439	1/60

Specifications | Shunt Trip Release Z-ASA, ZP-ASA

Description

- Remote release for subsequent mounting onto FAZ, FRBmM-1N, Z-MS
- Module width 1MU
- Additional installation of standard auxiliary switch is possible
- Position indicator red - green
- Type ZP-ASA for snap-on mounting

Technical Data

	Z-ASA24	Z-ASA230	ZP-ASA24	ZP-ASA230
Electrical				
Minimum pulse duration	15 ms	10 ms	15 ms	10 ms
Internal resistance	2.2 Ω	215 Ω	2.2 Ω	215 Ω
Duty cycle	100%	100%	100%	100%
Tripping time	< 20 ms	< 20 ms	< 20 ms	< 20 ms
Rated peak withstand voltage (1.2/50μs)	2.5 kV	2.5 kV	2.5 kV	2.5 kV
Endurance	> 4000 operating cycles	> 4000 operating cycles	> 4000 operating cycles	> 4000 operating cycles
AC voltage range				
Operating limit	10 V	60 V	10 V	60 V
Operational voltage range	12-110 V	110-415 V	12-110 V	110-415 V
Maximum current consumption during switch-on	15 A		2.1 A	15 A
Current flow time at max. current consumption	10 ms		10 ms	10 ms
DC voltage range				
Operating limit	9 V	72 V	9 V	72 V
Operational voltage range	10-60 V	110-220 V	10-60 V	110-220 V
Maximum current consumption during switch-on	21 A		1 A	21 A
Current flow time at max. current consumption	2 ms		2 ms	2 ms
Mechanical				
Frame size	45 mm	45 mm	45 mm	45 mm
Device height	80 mm	80 mm	80 mm	80 mm
Device width	17.5 mm (1MU)	17.5 mm (1MU)	17.5 mm (1MU)	17.5 mm (1MU)
Mounting	bonding	bonding	to snap on	to snap on
Degree of protection, built-in	IP40	IP40	IP40	IP40
Terminals above/below	open mouthed/lift	open mouthed/lift	open mouthed/lift with guide	open mouthed/lift with guide
Terminal capacity	1-25 mm ²	1-25 mm ²	1-25 mm ²	1-25 mm ²
Fastening torque of terminal screws	max. 2.4 Nm	max. 2.4 Nm	max. 2.4 Nm	max. 2.4 Nm

Connection diagram

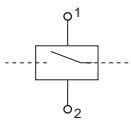

Dimensions (mm)

Z-ASA

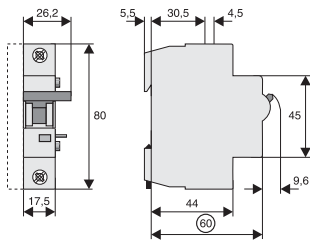

ZP-ASA

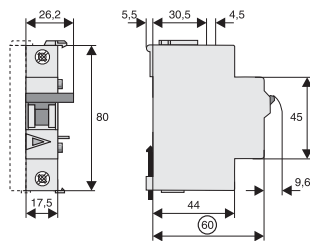

Connection Example 230 V

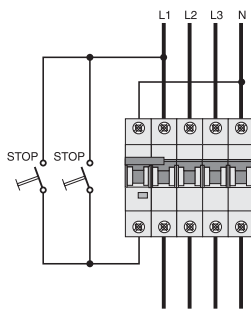

Connection Example 24 V

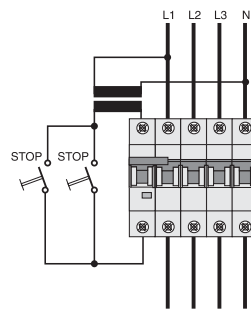

Example: Z-ASA + MCB

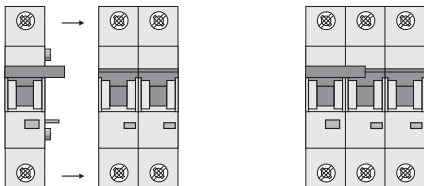

Example: ZP-ASA + MCB

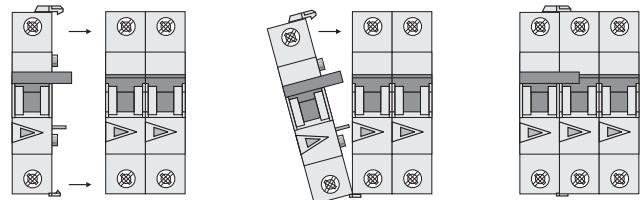

Undervoltage Release Z-USA, Z-USD

SG78811



Operational voltage range (V-) / Function	Type Designation	Article No.	Units per package
To be screwed on			
115 / undelayed	Z-USA/115	248288	1/60
230 / undelayed	Z-USA/230	248289	1/60
400 / undelayed	Z-USA/400	248290	1/60
115 / delayed 0.4s	Z-USD/115	248292	1/60
230 / delayed 0.4s	Z-USD/230	248291	1/60

Specifications | Undervoltage Release Z-USA, Z-USD

Description

- Tripping:
 - Instantaneous Z-USA
 - Delayed Z-USD, typ. 0,4 s
- Voltage control indicator blue/white
- Service key for zero voltage switch-on for testing purposes
- Can be used with FAZ

Technical Data

	Z-US./115	Z-US./230	Z-US./400
Electrical			
Rated voltage	U_n 115 V AC	230 V AC	400 V AC
Frequency	50-60 Hz	50-60 Hz	50-60 Hz
Making threshold	80% of U_n	80% of U_n	80% of U_n
Tripping threshold	50% of U_n	50% of U_n	50% of U_n
Mechanical			
Frame size	45 mm	45 mm	45 mm
Device height	80 mm	80 mm	80 mm
Device width	17.5 mm (1MU)	17.5 mm (1MU)	17.5 mm (1MU)
Mounting	quick fastening on DIN rail IEC/EN 60715		
Degree of protection, built-in	IP40	IP40	IP40
Terminals	open mouthed/lift	open mouthed/lift	open mouthed/lift
Terminal capacity	1 - 2x2.5 mm ²	1 - 2x2.5 mm ²	1 - 2x2.5 mm ²
Terminal protection	finger and hand touch safe, according to BGV A3, ÖVE-EN 6		

Connection diagram

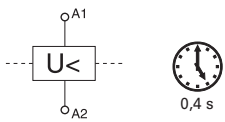

Dimensions (mm)

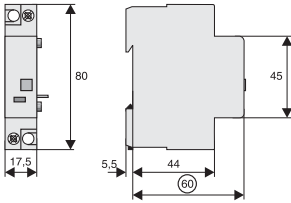

Connection Example Release

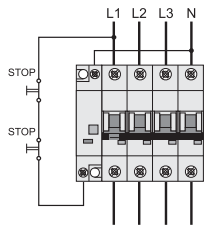

Connection Examples 400V and 230V

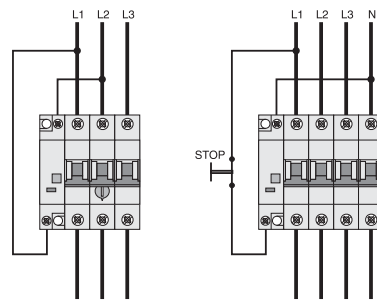

Connection example
Z-USA/400 + Z-MS

Connection example
Z-USA/230 + MCB

Switching interlocks IS/SPE-1TE, Z-IS/SPE-1TE

	Description	Type Designation	Article No.	Units per package
	Switching interlock without lock for Isolators, RCDs, combined RCD/MCBs, ...	IS/SPE-1TE	101911	5/30
	Switching interlock without lock for MCBs and Circuit Breaker ZP-A	Z-IS/SPE-1TE	274418	5/30

Specifications | Switching interlocks IS/SPE-1TE, Z-IS/SPE-1TE

Description

- Without lock
- Type IS/SPE-1TE:**
 - for Isolators, RCDs, combined RCD/MCBs, ...
- Type Z-IS/SPE-1TE:**
 - for MCB



Accessories for Add-on Residual Current Protection Unit FBHmV

Shunt Trip Release Kit Z-BHASA

Operational voltage range V~	Type Designation	Article No.	Units per package
110-415	Z-BHASA/230	248445	8
12-60	Z-BHASA/24	248444	8

SG09411



Specifications | Shunt Trip Release Kit Z-BHASA

Description

- Can be mounted subsequently
- Contact position indicator red - green
- Wide operational voltage range
- Sufficient power of extra low voltage source must be ensured
FBHmV-ASA/24: min. 90 VA
- Screws for mounting included FBHmV => BHASA => AZ

Accessories for Add-on Residual Current Protection Unit FBHmV

Technical Data

	Z-BHASA/24	Z-BHASA/230
Electrical		
Minimum pulse duration	15 ms	10 ms
Internal resistance	2 W	130 W
Duty	100%	100%
Tripping time	< 20 ms	< 20 ms
Peak withstand voltage (1.2/50µs)	2 kV	2 kV
Endurance	>4,000 operating cycles	>4,000 operating cycles
AC voltage range:		
Responding limit	8 V	70 V
Operational voltage range	12-60 V	110-415 V
Maximum current consumption during switch-on	14 A	3.4 A
Current flow time at max. current consumption	4.0 ms	4.5 ms
DC voltage range:		
Responding limit	11 V	90 V
Operational voltage range	12-60 V	110-230 V
Maximum current consumption during switch-on	23.5 A typ.	1.7 A typ.
Current flow time at max. current consumption	2 ms	4 ms
Mechanical		
Frame size	45 mm	45 mm
Device height	90 mm	90 mm
Device width	27 mm	27 mm
Mounting	quick fastening on DIN rail IEC/EN 60715	
Degree of protection, built-in	IP40	IP40
Upper and lower terminal screws	lift terminals	lift terminals
Terminal capacity	2.5-30 mm ²	2.5-30 mm ²
Fastening torque of terminal screws	4 Nm	4 Nm

Connection diagram

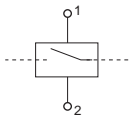

Dimensions (mm)

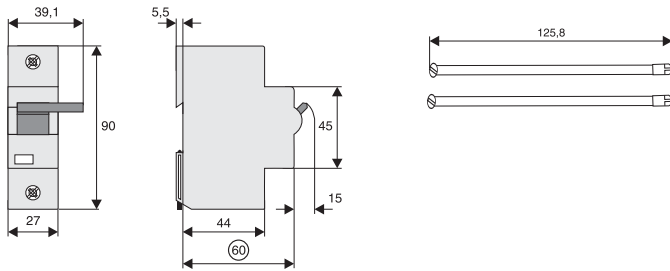

Accessories for Miniature Circuit Breakers AZ

Shunt Trip Release Z-LHASA

	Operational voltage range V~	Type Designation	Article No.	Units per package
	110-415	Z-LHASA/230	248442	8
	12-60	Z-LHASA/24	248441	8

Specifications | Shunt Trip Release Z-LHASA

Description

- Can be mounted subsequently
- Contact position indicator red - green
- Wide operational voltage range
- Sufficient power of extra low voltage source must be ensured
Z-LHASA/24: min. 90 VA

Technical Data

	Z-LHASA/24	Z-LHASA/230
Electrical		
Minimum pulse duration	15 ms	10 ms
Internal resistance	2 W	130 W
Duty	100%	100%
Tripping time	< 20 ms	< 20 ms
Peak withstand voltage (1.2/50µs)	2 kV	2 kV
Endurance	>4,000 operating cycles	>4,000 operating cycles
AC voltage range:		
Responding limit	8 V	70 V
Operational voltage range	12-60 V	110-415 V
Maximum current consumption during switch-on	14 A	3.4 A
Current flow time at max. current consumption	4.0 ms	4.5 ms
DC voltage range:		
Responding limit	11 V	90 V
Operational voltage range	12-60 V	110-230 V
Maximum current consumption during switch-on	23.5 A typ.	1.7 A typ.
Current flow time at max. current consumption	2 ms	4 ms
Mechanical		
Frame size	45 mm	45 mm
Device height	90 mm	90 mm
Device width	27 mm	27 mm
Mounting	quick fastening on DIN rail IEC/EN 60715	
Degree of protection, built-in	IP40	IP40
Upper and lower terminal screws	lift terminals	lift terminals
Terminal capacity	2.5-30 mm ²	2.5-30 mm ²
Fastening torque of terminal screws	4 Nm	4 Nm

Connection diagram

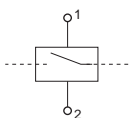

Dimensions (mm)

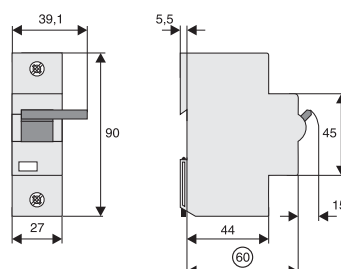

Accessories for Miniature Circuit Breakers AZ

Auxiliary Switch Z-LHK

Function	Type Designation	Article No.	Units per package
1NO+1NC	Z-LHK	248440	10/100

SG16111



Specifications | Auxiliary Switch Z-LHK

Description

- Auxiliary switch according to IEC 947-5-1
- Can be mounted subsequently

Technical Data

		Z-LHK
Electrical		
Contact function		1NO + 1NC
Rated voltage		250 V
Frequency		50/60 Hz
Rated current		8 A
Rated thermal current	I_{th}	8 A
Utilisation category AC13		
Rated operational current	I_e	6A/250V AC 2A/440V AC
Utilisation category AC15		
Rated operational current	I_e	–
Utilisation category DC12		
Rated operational current	I_e	–
Utilisation category DC13		
Rated operational current	I_e	0.5A/230V DC 2A/110V DC 4A/60V DC
Rated insulation voltage	U_l	250 V AC
Minimum operational voltage per contact	U_{min}	24 V AC/DC
Minimum operational current	I_{min}	50 mA AC/DC
Rated peak withstand voltage	$U_{imp} (1.2/50\mu)$	2.5 kV
Conditional short circuit current	I_k	1 kA
with back-up fuse 6A or FAZ-B4-HS		
Max. back-up fuse, overload and short circuit		6 A gL / FAZ-4/..../B-HS
Mechanical		
Can be mounted from the left onto		AZ
Can be mounted from the right onto		–
Tripping indicator "electrical tripping"		–
Frame size		45 mm
Device height		80 mm
Device width		8.8 mm (0.5MU)
Mounting		onto switching device
Degree of protection, built-in		IP40
Terminal protection		finger and hand touch safe according to BGV A3, ÖVE-EN 6
Terminals		lift terminals
Terminal capacity		0.5-2.5 mm ²
Terminal screws		M3 (PoziDrive Z0)
Fastening torque of terminal screws		max. 0.8-1.0 Nm

Connection diagram



Dimensions (mm)

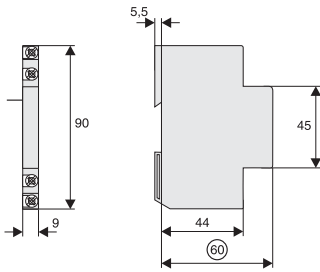

Accessories for Miniature Circuit Breakers AZ

Interlocks LH-SP

	Function	Type Designation	Article No.	Units per package
	Tripping interlock	LH-SPL	285752	1
	Tripping interlock	LHSP-E	215999	1
	Switchoff interlock	LHSP-A	216000	1

Specifications | Anti-Tamper Device LHSP-E, LH-SPL

Description

- Prevents undesired switching ON or OFF

Specifications | Switchoff Interlock LHSP-A

Description

- Prevents undesired switch-OFF

Dimensions (mm)

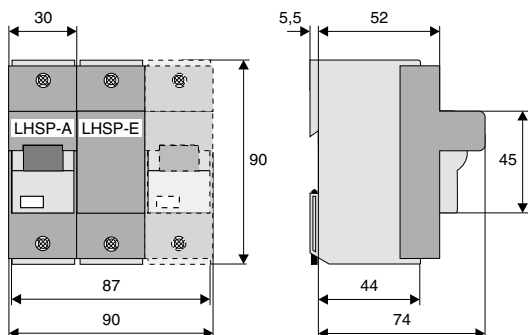

Accessories for Miniature Circuit Breaker FAZ-...-NA, -RT

Auxiliary Contact Z-IHK-NA

	Operational Voltage Range	Type Designation	Article No.	Units per package
	250 VAC	Z-IHK-NA	113895	1

Specifications | Auxiliary Contact Z-IHK-NA

Description

- Design according to IEC/EN 60947-5-1, IEC/EN 62019
- Field installable
- The specified minimum voltages are per contact—take into account particularly in case of series connection
- Self-cleaning contacts
- Contact material and design particularly suitable for extra low voltage
- Tripping signal contact transmits message of electric tripping, not mechanical switch-off
- Test key for contact function “electrical tripping”
- Will allow for > 480Y/277 VAC rating

Technical Data

		Z-IHK-NA
Electrical		
Contact function		1NO + 1NC
Rated voltage		250V
Rated current		6A
Rated thermal current	I_{th}	6A
Utilization category AC13		
Rated operational current	I_e	3A/250 Vac
Utilization category AC15		
Rated operational current	I_e	2A/250 Vac
Utilization category DC12		
Rated operational current	I_e	0.5A/110 Vdc
Rated insulation voltage	U_i	250 Vac
Minimum operational voltage per contact	U_{min}	5 Vdc
Minimum operational current	I_{min}	10 mA AC/DC
Rated peak withstand voltage	$U_{imp} (1.2/50\mu)$	4 kV
Conditional short circuit current	I_k	
with Back-Up Fuse 6A		1 kA
Max. back-up fuse, overload and short circuit		6 A gL / FAZ-4/..-B-HS
Mechanical		
Tripping indicator “electrical tripping”		—
Frame size		45 mm
Device height		80 mm
Device width		8.8 mm (0.5MU)
Mounting		—
Degree of protection, built-in		IP40
Terminal protection		Finger and hand touch safe according to BGV A3, ÖVE-EN 6
Terminals		Lift terminals
Terminal capacity		0.5–2.5 mm ²
Terminal screws		M3 (Pozidrive Z2)
Tightening torque of terminal screws		max. 1.2 Nm

Connection diagram

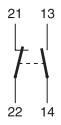

Dimensions (mm)

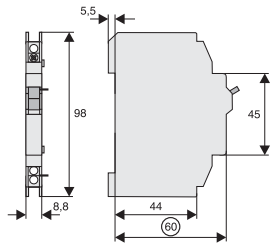

Accessories for Miniature Circuit Breaker FAZ-..-NA, -RT

Shunt Trip FAZ-XAA-NA

SG13511



Operational Voltage Range	Type Designation	Article No.	Units per package
12–110 VAC 12–60 VDC	FAZ-XAA-NA12-110VAC	102037	1
110–415 VAC 110–230 VDC	FAZ-XAA-NA110-415VAC	102036	1

Specifications | Shunt Trip FAZ-XAA-NA

Description

- Remote release for subsequent mounting onto FAZ-NA
- Additional installation of standard auxiliary switch is possible
- Position indicator red–green



Technical Data

	FAZ-XAA-NA12-110VAC	FAZ-XAA-NA110-415VAC
Electrical		
Can be mounted onto	FAZ-NA / FAZ-NA-DC / FAZ-RT	FAZ-NA / FAZ-NA-DC / FAZ-RT
Operational voltage range	12–110 Vac 12–60 Vdc	110–415 Vac 110–230 Vdc
Frequency	50/60 Hz	50/60 Hz
Mechanical		
Frame size	45 mm	45 mm
Device height	105 mm	105 mm
Device width	17.5 mm	17.5 mm
Mounting	Quick fastening with two lock-in positions on EN 50022	
Degree of protection, built-in	IP40	IP40
Terminal protection	Finger and hand touch safe according to BGV A3, ÖVE-EN 6	Finger and hand touch safe according to BGV A3, ÖVE-EN 6
Terminals	Open mouthed/lift	Open mouthed/lift
Terminal capacity, one and two wires	18–10 AWG	18–10 AWG

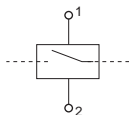

Connection diagram



Terminal Covers

	Description	Type Designation	Article No.	Units per package
<small>SG82011</small> 	Terminal Covers for RCDs			
	2-pole	Z-RC/AK-2TE	285385	10
	4-pole	Z-RC/AK-4TE	101062	10
<small>SG02614</small> 	Terminal Covers for Add-on Device			
	2-pole	Z-TC/AO-2P	178097	10
	3+4-pole	Z-TC/AO-3-4P	178098	10
<small>SG02314</small> 	Terminal Covers for MCB, RCBO			
	2-pole	Z-TC/SD-2P	178099	10
	3-pole	Z-TC/SD-3P	178100	10
	4-pole	Z-TC/SD-4P	178101	10
	Terminal Cover for MCB			
	1-pole	Z-TC/MCB-1P	178102	10

Remote Control and Automatic Switching Device Z-ZW

Function	Type Designation	Article No.	Units per package	
 SG30811	Automatic restarting 230VAC	Z-FW-LP	248296	1/20
	Automatic restarting 24-48VDC	Z-FW-LPD	265244	1/20
 SG30711	+ Remote control module ON/OFF/TEST (only in connection with Z-FW-LP, -LPD from delivery date 2006!)	Z-FW-MO	284730	1

Pre-mounted sets Z-FW

Operational voltage range	Type Designation	Article No.	Units per package
 SG31311	Automatic restoring + remote control		
	230 VAC	Z-FW-LP/MO	290171
24-48 VDC	Z-FW-LPD/MO	290172	1/12
	Remote control		
	230 VAC	Z-FW-LPE/MO	108104
24-48 VDC	Z-FW-LPS/MO	100052	1/12

Remote Testing Module Z-FW (for Z-FW-LP/MO set use only)

Operational voltage range	Type Designation	Article No.	Units per package	
 SG12111	0.01 A	Z-FW/001	248297	4/120
	0.03 A	Z-FW/003	248298	4/120
	0.1 A	Z-FW/010	248299	4/120
	0.3 A	Z-FW/030	248300	4/120
	0.5 A	Z-FW/050	248301	4/120

Specifications | Remote Control and Automatic Switching Z-FW

Description

- Shape compatible switching device suitable for subsequent installation for automatic re-setting and remote control of MCBs, RCCBs and Z-MS
- Mechanical interlock, can be sealed with leads
- Mechanical switching capability up to max. RCCB-100/4p, MCB-100/4p
- Operating and alarm display by green and red LED
- Function extension with Switching Modul Z-FW-MO
Operating and trouble display by LED pre-assembled only with Z-FW...

Technical Data

	Z-FW-LP	Z-FW-LPD	Z-FW-MO
Electrical			
Possible operating voltages	220-240 V AC	24-48 V DC	–
Frequency	50/60 Hz	–	–
Testing module (0.5MU) for remote testing of RCDs	Z-FW...	Z-FW...	–
Control voltage for remote control	–	–	24-230 V AC/DC
Relay output for tripping test with Z-FW	–	–	400 V AC max.
Relay output for alarm, potential-free	5A/250V AC	5A/250V AC	–
Functions	automatic restarting	automatic restarting	+ON/OFF/TEST
Function selector	Automatic 5x, OFF/RESET	Automatic 5x, OFF/RESET	ON, OFF/RESET
Remote control function via telephone with Telecommander	–	–	–
Mechanical			
Frame size	45 mm	45 mm	45 mm
Device height	80 mm	80 mm	80 mm
Device width	70 mm	70 mm	35 mm
Mounting	quick fastening with 2 lock-in positions on DIN rail IEC/EN 60715		–
Degree of protection, built-in	IP40	IP40	IP40
Terminal protection	finger and hand touch safe according to BGV A3, ÖVE-EN 6		
Terminals	lift terminals	lift terminals	lift terminals
Terminal capacity	2 x 1.5 mm ² or 1 x 2.5 mm ²	2 x 1.5 mm ² or 1 x 2.5 mm ²	4 x 1.5 mm ² or 2 x 2.5 mm ²
Scope of delivery	–	–	Coupling plug

	Z-FW-LP/MO	Z-FW-LPD/MO	Z-FW-LPE/MO	Z-FW-LPS/MO
Electrical				
Possible operating voltages	220-240 V AC	24-48 V DC	220-240 V AC	24-48 V DC
Frequency	50/60 Hz	–	50/60 Hz	–
Testing module (0.5MU) for remote testing of RCDs	Z-FW...	Z-FW...	Z-FW...	Z-FW...
Control voltage for remote control	24-230 V AC/DC	24-230 V AC/DC	24-230 V AC/DC	24-230 V AC/DC
Relay output for tripping test with Z-FW	400 V AC max.	400 V AC max.	400 V AC max.	400 V AC max.
Relay output for alarm, potential-free	5A/250V AC	5A/250V AC	5A/250V AC	5A/250V AC
Functions	automatic restarting + remote control	remote control	remote control	remote control
Mechanical				
Frame size	45 mm	45 mm	45 mm	45 mm
Device height	80 mm	80 mm	80 mm	80 mm
Device width	105 mm	105 mm	105 mm	105 mm
Mounting	quick fastening with 2 lock-in positions on DIN rail IEC/EN 60715			
Degree of protection, built-in	IP40	IP40	IP40	IP40
Terminal protection	finger and hand touch safe according to BGV A3, ÖVE-EN 6			
Terminals	lift terminals	lift terminals	lift terminals	lift terminals

Connection diagram

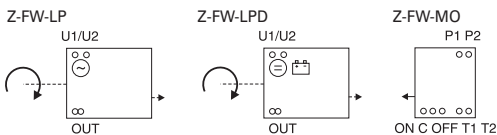

Dimensions (mm)

Z-FW-LP, -LPD, -LPE, -LPS

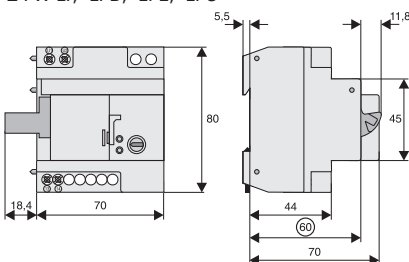

Z-FW-MO

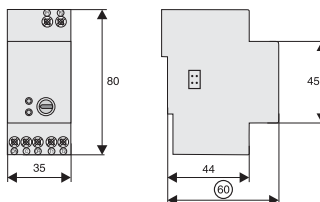

Connection example

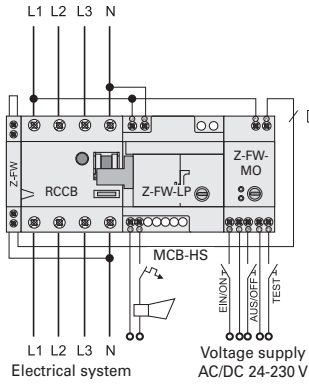
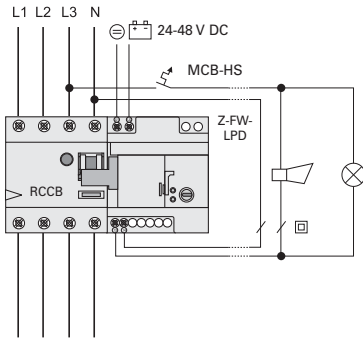

Specifications | Remote Testing Module Z-FW (for Z-FW-LP)

Description

- External testing module with testing resistor for RCDs
- Proper "external" test key function according to the applicable rules thanks to design adapted to the rated tripping current
- For remote testing with remote control and automatic switching device Z-FW-LP
- No undesired voltage rise in the consumer system during remote switch-off thanks to integrated breaker contact K1-K2
- Can also be used as a remote tripping module for RCDs

Dimensions (mm)

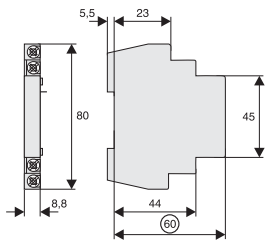

Connection examples

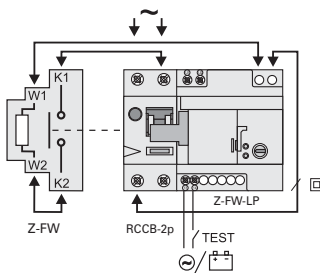

Connection diagram:
RCCB-2p, RCD feed above

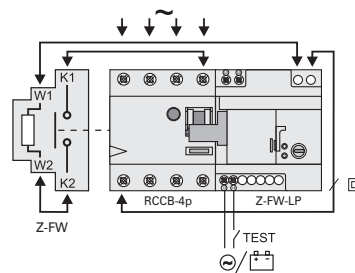

Connection diagram:
RCCB-4p, RCD feed above

Approvals and shipping classifications for world markets

In their basic version, the Moeller-branded Eaton devices are approved for use throughout the world, including the USA and Canada. As such, they can be used without restriction as devices for world markets.

The standard versions of some devices, such as circuit breakers, can be used worldwide except in the USA and Canada.

For export to North America, numerous devices are available in special UL- and CSA-approved versions.

For currently available approvals, see our website:

<https://wss.moeller.net/approbationen/step1.do>

Eaton's Moeller-branded low-voltage switchgear and switchgear assemblies conform to national and international specifications, making it possible to construct control systems that will conform to the national and international specifications of any country in the world.

This, of course, means that due consideration must be given to the national standards of the respective country, such as those concerning installation, operation, installation materials and methods, as well as any pertaining to circumstances such as severe environmental conditions.

The device rating data given in this catalog for 220 – 240 V, 380 – 440 V, 500 V, 600 V, and 690 V covers virtually all existing three-phase systems worldwide.

Deviating requirements for the USA and Canada are given in detail in each chapter of this catalog. Read also the detailed description "Switchgear for North America" from Page 22/13. For the worldwide use of switchgear, special installation standards and approval requirements must also be observed in addition to the widely differing system conditions:

Where screw fuses are used in a control system, some European countries – such as Denmark, Finland, the Netherlands, Norway and Sweden – require gage screws. In this case, "FORM P" fuse bases must be used. Switzerland no longer requires the use of gage screws, but they are still often requested by customers.

The majority of countries permit the import of switchgear assemblies and devices on the manufacturer's undertaking that they have been constructed in accordance with the pertinent specifications. In some countries, such as the USA and Canada, however, there is a legal obligation to obtain official approval. In these countries, devices and enclosures – sometimes even complete control systems – are tested and approved by independent bodies.

In Scandinavia and in Switzerland, an official approval for low-voltage switchgear and controlgear had to be sought to some extent. For industrial switchgear, this legal obligation has now been abolished, provided the devices have been manufactured and tested in accordance with harmonized European standards (such as IEC/EN 60947). There is then no longer a requirement for them to carry their country's own approval mark. Eaton develops switchgear to international

standards, such as IEC/EN 60947 and applies the corresponding marks. Devices that conform to the European Low-Voltage Directive and are sold within the European Union must contain the CE mark.



Europe, Conformité Européen (CE)

The CE mark indicates that the device corresponds with all relevant requirements and standards. Mandatory marking allows unrestricted use of marked devices within the European economic area.

Devices sold within the European union must comply with the Electromagnetic Compatibility (EMC) Directive. Eaton has performed the required tests for all Moeller-branded products subject to this Directive and applied the CE mark, which demonstrates compliance with the EMC Directive.

Because devices bearing the CE mark comply with the harmonized standards, approval and the associated marking is no longer required in the following countries: Belgium, Denmark, Finland, France, the Netherlands, Norway, Sweden, and Switzerland.

An exception is installation material. In some areas, miniature circuit breakers and residual current device must still be labeled and therefore carry the corresponding approval mark.



Belgien, Comité Electrotechnique Belge/Belgisch Elektrotechnisch Comité (CEBEC)



Germany, Verband Deutscher Elektrotechniker (VDE)



France, Union Technique de l'Electricité (UTE)



Austria, Österreichischer Verband für Elektrotechnik (ÖVE)



Switzerland, Schweizerischer Elektrotechnischer Verein (SEV)

Devices for export to the USA and Canada have either additional UL and CSA approval or are available in a separate version with UL and CSA approval.



USA, Underwriters Laboratories (UL) - Listing



USA, Underwriters Laboratories (UL) - Recognition



Canada, Canadian Standards Association (CSA)

Approval for electrical products is also required in Argentina, China, Russia, South Africa, and the Ukraine.

Marking is partly mandatory for these countries. As in other European countries, the IEC rating data is accepted here.

Romania requires that components that are to be used in public buildings must be approved by the Romanian test authority ICECON.

Russia

Devices for Russia must bear the appropriate marking.



Russia, Goststandart (GOST-R)

Ukraine

Devices for the Ukraine must bear the appropriate marking.



Ukraine, Goststandart (Ukrain-GOST)

China

Devices for China must bear the appropriate marking.



China, China Compulsory Certification (CCC)

South Africa

In South Africa approval is mandatory for circuit breakers and busbar trunking systems: These devices must bear the appropriate marking.



South Africa, South African Bureau of Standards (SABS)

Argentina

In Argentina, mandatory approval is based on Resolution 92/98. From April 01, 2001, miniature circuit breakers and residual-current circuit breakers are subject to mandatory approval. As of this date, circuit breakers up to $I_n = 63$ A and $U_e \text{ max} = 440$ V must carry the following marks:



Argentinien, Instituto Argentino de Normalización y Certificación (IRAM)

Selection of devices

In addition to the required approvals and conformance with applicable regulations, the design of devices and systems themselves must be suitable for the target market.

Points to keep in mind when selecting switchgear for export include:

Motor-protective circuit breakers

Use auto-protected circuit breakers, which are capable of controlling the highest prospective fault levels at the point of installation without the need for back-up protection.

Advantages

Can be positioned anywhere and are fully independent of the local circuit-protection system; no spare part problems

Circuit-breakers

Use makes with visible contacts, and quick-make and quick-break operation as standard. For high short-circuit levels, use current-limiting circuit breakers. Selective switches are recommended for the selective graduation of networks.

Advantages

Independence from local accident prevention regulations requiring visible contacts, and safety from faults caused by inexperienced operating personnel. The effects of shortcircuits are kept to a minimum. Fuseless installations offer greater safety and reliability in plant operation. In the event of a fault, only the faulty section of the system is isolated.

Contactors

Use contactors whose entire range provides consistently reliable operation in the event of voltage drops (80% U_n should be aimed for) and whose contact system will not assume an indeterminate position on closing or opening under these conditions.

Advantages

During the electrification work in areas such as Africa and the Middle East, an insufficient voltage stability is – at least for a certain time – likely in many applications (for example due to long spur lines or small local generators).

The use of devices that fulfil the above requirements will eliminate one of the main failure causes related to contactors.

Enclosures

Use insulated enclosures with transparent covers (i.e. "totally insulated" enclosures).

Approvals and shipping classifications for world markets

Advantages

Total insulation is the best possible protective measure from the user's point of view, avoiding, reliance on the possibly doubtful skills of unknown installation personnel. Furthermore, protective measures based on grounding are often extremely difficult, if not impossible (in the Middle East, for example, due to the dryness of the ground). Insulated enclosures completely eliminate the need for any additional protection against corrosion. The transparent covers contribute significantly to the correct operation of a system, because switchgear operation can be monitored even with the doors or covers closed, thus virtually eliminating the possibility of these being left open through carelessness. The transparent cover is an important contribution to safety, especially where exports to areas of uncertain skills are concerned.

Overcurrent protection devices

Always use circuit breakers or motor-protective circuit breakers and avoid fuses wherever possible.

Advantages

The operational reliability of a system is especially important for export contracts. Circuit-breakers and motor-protective circuit breakers provide this reliability in full measure since they can be immediately reclosed once a fault has been cleared, they disconnect all poles, they have ideal protection through high tripping accuracy and they can be used for selective operation. Because they have no fuses or other consumables, they also greatly reduce the problem of obtaining replacement parts. The advantages of fuseless design for export are especially evident in this case. No complicated investigation is needed to find out which fusing system is used in the respective location and which specifications have to be followed to select the correct fuses. Often several different fuse systems with widely varying characteristics are used side-by-side in the same country. For the uninitiated, it may be almost impossible to find the right fuse in these circumstances.

These problems do not arise where a circuit-breaker is used.

Main switch and safety switch

Use devices with positive contact separation and clear switch position indication.

Advantages

The mechanical coupling of the actuating element with the contacts ensures that the Off position is indicated only when all main contacts are separated by the prescribed distance, and only in this position can the switch be padlocked. This ensures safety when carrying out maintenance and repair work on the installation or machinery.

Shipping classifications

Many Moeller-branded Eaton devices are approved by all important shipping associations: Germanischer Lloyd, Lloyd's Register of Shipping, Bureau Veritas, Russian Maritime Register of Shipping, Registro Italiano Navale, Det Norske Veritas, Polski Rejestr Statków, etc.

Because the status of currently valid shipping approvals is subject to significant variations, this Catalog does not provide an overview, as this would quickly be out of date.

Please see our corresponding, up-to-date information on the Internet. <https://wss.moeller.net/approbationen/schiff.do>

Switchgear for the global market and for North America:

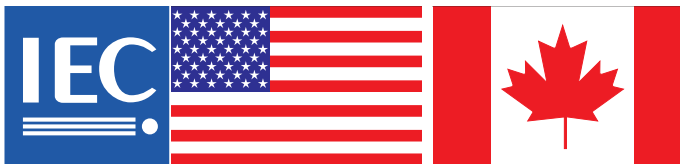

Practically all devices can be used in compliance with IEC norms.

The selection pages of this catalogue indicate the products that have been approved for the North American market with the USA and Canadian flags. This does not mean these devices are exclusively for North America! Approval for North America has been granted special emphasis due to the strong export share of these devices and because standards deviate from IEC/EN norms, selection and processing requirements must be highlighted. The article "Switchgear for North America" in the appendix of this catalogue contains everything you need to know about this subject. A glossary in the appendix explains the specifically American technical terms.

Information relevant for export to North America



Product Standards	IEC/EN 60947-5; UL 508, CSA-C22.2 No. 14; CE marking
UL File No.	E29184
UL CCN	NKCR
CSA File No.	12528
CSA Class No.	3211-03
NA Certification	UL Listed, CSA Certified
Degree of Protection	IEC: IP65, UL/CSA Type 3R, 4X (indoor use only), 12, 13

Example for such an instruction.

The Std. pack column on the order pages also uses flags to indicate the articles for which the UL/CSA notes apply. Selecting a technically appropriate device also opens information to help you document suitability for use in North America on your own with a minimum of research (see above).

Eaton is a power management company with approximately 97,000 employees. The company provides energy-efficient solutions that help our customers effectively manage electrical, hydraulic and mechanical power more efficiently, safely and sustainably. Eaton sells products to customers in more than 175 countries.

For more information, visit www.eaton.eu.



Eaton Industries (Austria) GmbH
Scheidgasse 42
1210 Wien
Austria

Eaton Industries Manufacturing GmbH
EMEA Headquarters
Route de la Longeraie
1110 Morges
Switzerland

© 2016 Eaton Industries (Austria) GmbH
Subject to technical modifications. No
responsibility is taken for misprints or errata.
Printed in Austria (08/16)
Publication number CA003002EN

Graphics: SRA
Print: