

Inductive sensors
Optical sensors
Capacitive sensors

Product range catalog

Sensors – products,
basic information, applications

EATON

Powering Business Worldwide



CUTLER-HAMMER COOPER
 BUSSMANN POWERWARE
 MEM BILL
 CROUSE-HINDS MOELLER
 SANTAK HOLEC
 WESTINGHOUSE
 MGE OFFICE PROTECTION SYSTEMS
 B-LINE

EAT•N

Powering Business Worldwide

The power of fusion.

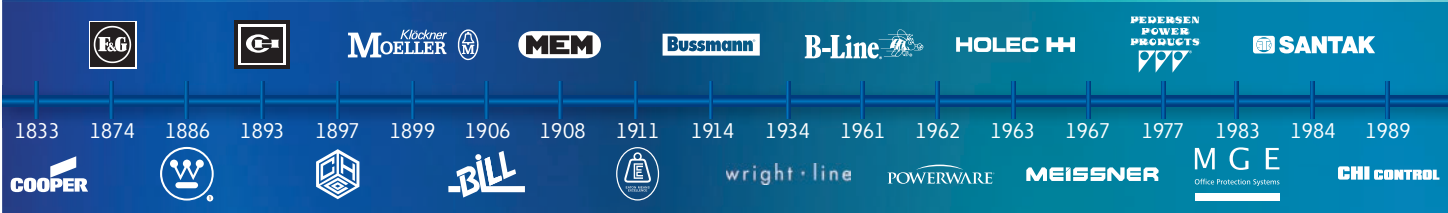

EAT•N

Powering Business Worldwide

There's a certain energy at Eaton. It's the power of uniting some of the world's most respected names to build a brand you can trust to meet your every power management need.

Eaton is dedicated to ensuring that reliable, efficient and safe power is available when it's needed most. Building on over 100 years of experience in electrical power management, the experts at Eaton deliver customized, integrated solutions to solve your most critical challenges. To learn more visit www.eaton.eu/electrical.

All of the above are trademarks of Eaton or its affiliates. •Eaton has a license to use the Westinghouse brand name in Asia Pacific. ©2013 Eaton.

Inductive Sensors

E52 Cube Series	
Description	8
Ordering/Engineering/Dimensions	9
Technical data	10
E55 Limited Switch Style Series	
Description	11
Ordering	12
Technical data	13
Engineering/Dimensions	14
E56 Pancake Series	
Description	15
Ordering/Engineering/Dimensions	16
Technical data	17
E57 Global Series	
Description	18
Ordering	19
Engineering	23
Technical data	24
Dimensions	26
E57 Premium+ Short Series	
Description	28
Ordering	29
Engineering	35
Technical data	36
Dimensions	37
E57 Miniatur Series	
Description	39
Ordering/Technical data	40
Engineering/Dimensions	41
iProx Series	
Description	42
Ordering	43
Technical data/Engineering/Dimensions	44
E59 AccuProx Series	
Description	45
Ordering	47
Engineering	48
Technical data	49
Dimensions	49

Optical sensors

Comet Series	
Description Comet-Serie	50
Ordering Comet-Serie	51
Description FO cable	56
Ordering FO cable	57
Engineering	59
Technical data	61
Dimensions	62
E58 Harsh Duty Series	
Description	66
Ordering	67
Engineering	68
Dimensions/Technical data	69
E65 SM Series	
Description	70
Ordering	71
Technical data	72
Engineering/Dimensions	73
E67 Long Range Series	
Description	74
Ordering/Dimensions	75
Engineering/Technical data	76
E71 NanoView Series	
Description	77
Ordering	78
Engineering	79
Technical data/Dimensions	80
E75/E76 IntelliView Series	
Description	81
Ordering	84
Engineering	85
Technical data	87
Dimensions	88

Capacitive sensors

E53 Capacitive Series	
Description	89
Ordering	90
Engineering	93
Technical data	93
Dimensions	94

Accessories

Ordering	95
Dimensions	100

Basic information 103

Applications 113

Appendix 116



Energizing a world that demands more.

Discover today's Eaton.

Powering business worldwide

As a global diversified power management company, we help customers worldwide manage the power needed for buildings, aircraft, trucks, cars, machinery and businesses.

Eaton's innovative technologies help customers manage electrical, hydraulic and mechanical power more reliably, efficiently, safely and sustainably.



Powering Business Worldwide



We deliver:

- **Electrical solutions** that use less energy, improve power reliability and make the places we live and work safer and more comfortable
- **Hydraulic and electrical solutions** that enable machines to deliver more productivity without wasting power
- **Aerospace solutions** that make aircraft lighter, safer and less costly to operate, and help airports operate more efficiently
- **Vehicle drivetrain and powertrain solutions** that deliver more power to cars, trucks and buses, while reducing fuel consumption and emissions

We provide integrated solutions that help make energy, in all its forms, more practical and accessible.

With 2012 sales of \$16.3 billion, Eaton has approximately 103,000 employees around the world and sells products in more than 175 countries.



Eaton's electrical business

Eaton is a global leader with expertise in:

- Power distribution and circuit protection
- Backup power protection
- Solutions for harsh and hazardous environments
- Lighting and security
- Structural solutions and wiring devices
- Control and automation
- Engineering services

Eaton is positioned through its global solutions to answer today's most critical electrical power management challenges. With 100 years of electrical experience behind us, we're energized by the challenge of powering up a world that demands twice as much energy as today. We're anticipating needs, engineering products, and creating solutions to energize our markets today and in the future.

We are dedicated to ensuring that reliable, efficient and safe power is available when it's needed most.

www.eaton.eu

Eaton Catalogs in the App Store – all catalogs close at hand!

In order to meet the needs of increasingly mobile customers and employees, Eaton is offering a mobile solution for communication and product information.

Clearly designed shelf view

The Eaton Catalogs app offers an outstandingly clear user interface and several fully developed functions. In the form of a shelf view, the user is provided with a clear overview of Eaton's latest product catalogs. These can be leafed through on the fly or downloaded to the device – for situations when there is no Internet access. Choose for yourself which catalogs are of interest and keep up-to-date using the Update function.

Intuitive browsing, searching and finding

Users can simply browse through the catalogs with intuitive navigation ensured. A linked table of contents, thumbnail views and a rapid search function are also provided for finding information quickly and conveniently.

Linked data sheets

It is often the case that product information is required which is not available in the product catalogs. The "Eaton Catalogs" contain article numbers and type designations that are linked to the Online Catalog. This enables the user to access highly detailed production information in the form of a technical data sheet. From here other documents such as installation instructions and technical publications can be called up.

Whether on the building site, at the customer, on the train or at home – "Eaton Catalogs" make sure that all product information is close to hand.

EATON Now available in the App Store

Article name	Series	Reference
RMQ-0.5	25000	25000
RMQ-0.6	25000	25000
RMQ-0.7	25000	25000
RMQ-0.8	25000	25000
RMQ-0.9	25000	25000
RMQ-1.0	25000	25000
RMQ-1.1	25000	25000
RMQ-1.2	25000	25000
RMQ-1.3	25000	25000
RMQ-1.4	25000	25000
RMQ-1.5	25000	25000
RMQ-1.6	25000	25000
RMQ-1.7	25000	25000
RMQ-1.8	25000	25000
RMQ-1.9	25000	25000
RMQ-2.0	25000	25000
RMQ-2.1	25000	25000
RMQ-2.2	25000	25000
RMQ-2.3	25000	25000
RMQ-2.4	25000	25000
RMQ-2.5	25000	25000
RMQ-2.6	25000	25000
RMQ-2.7	25000	25000
RMQ-2.8	25000	25000
RMQ-2.9	25000	25000
RMQ-3.0	25000	25000
RMQ-3.1	25000	25000
RMQ-3.2	25000	25000
RMQ-3.3	25000	25000
RMQ-3.4	25000	25000
RMQ-3.5	25000	25000
RMQ-3.6	25000	25000
RMQ-3.7	25000	25000
RMQ-3.8	25000	25000
RMQ-3.9	25000	25000
RMQ-4.0	25000	25000
RMQ-4.1	25000	25000
RMQ-4.2	25000	25000
RMQ-4.3	25000	25000
RMQ-4.4	25000	25000
RMQ-4.5	25000	25000
RMQ-4.6	25000	25000
RMQ-4.7	25000	25000
RMQ-4.8	25000	25000
RMQ-4.9	25000	25000
RMQ-5.0	25000	25000
RMQ-5.1	25000	25000
RMQ-5.2	25000	25000
RMQ-5.3	25000	25000
RMQ-5.4	25000	25000
RMQ-5.5	25000	25000
RMQ-5.6	25000	25000
RMQ-5.7	25000	25000
RMQ-5.8	25000	25000
RMQ-5.9	25000	25000
RMQ-6.0	25000	25000
RMQ-6.1	25000	25000
RMQ-6.2	25000	25000
RMQ-6.3	25000	25000
RMQ-6.4	25000	25000
RMQ-6.5	25000	25000
RMQ-6.6	25000	25000
RMQ-6.7	25000	25000
RMQ-6.8	25000	25000
RMQ-6.9	25000	25000
RMQ-7.0	25000	25000
RMQ-7.1	25000	25000
RMQ-7.2	25000	25000
RMQ-7.3	25000	25000
RMQ-7.4	25000	25000
RMQ-7.5	25000	25000
RMQ-7.6	25000	25000
RMQ-7.7	25000	25000
RMQ-7.8	25000	25000
RMQ-7.9	25000	25000
RMQ-8.0	25000	25000
RMQ-8.1	25000	25000
RMQ-8.2	25000	25000
RMQ-8.3	25000	25000
RMQ-8.4	25000	25000
RMQ-8.5	25000	25000
RMQ-8.6	25000	25000
RMQ-8.7	25000	25000
RMQ-8.8	25000	25000
RMQ-8.9	25000	25000
RMQ-9.0	25000	25000
RMQ-9.1	25000	25000
RMQ-9.2	25000	25000
RMQ-9.3	25000	25000
RMQ-9.4	25000	25000
RMQ-9.5	25000	25000
RMQ-9.6	25000	25000
RMQ-9.7	25000	25000
RMQ-9.8	25000	25000
RMQ-9.9	25000	25000
RMQ-10.0	25000	25000

Eaton Online Catalog – find product details quickly and efficiently!

You can find comprehensive up-to-date product information at <http://ecat.moeller.net>

Lookup

You can search by keywords, product names, article numbers, technical data: The search understands everything and takes you straight to the product you're looking for.

Graphical navigation

Graphical representation of the fields of application and product groups.

Selection aids

Tailored to the typical expert's approach, this search aid helps you quickly find the product you need.

Data sheets

For every article the catalog can generate a technical data sheet, which you can convert to a PDF file for printing or saving with a single click.

Parts lists

From your search results you can create a parts list that you can then send to your Eaton sales partner as a query.

You can find comprehensive up-to-date information about Eaton's automation products and switchgear in our Online Catalog.

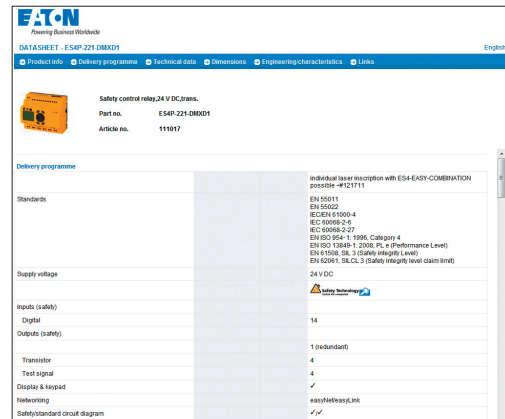

HTML data sheet; can be saved as PDF file.

The screenshot shows a parts list table with columns for Item, Qty., Photo, Article no., Part no., and Short Text. The table contains five rows of parts, each with a checkbox in the 'Item' column. Below the table are buttons for 'Delete position', 'Save changes', and 'Add free position'.

Item	Qty.	Photo	Article no.	Part no.	Short Text
<input type="checkbox"/>	1		111017	ES4P-221-DMX01	Safety control relay 24 V DC,trans.
<input type="checkbox"/>	1		228758	FAK-COMBINATION*	Complete unit
<input type="checkbox"/>	1		284831	M225-DDLM-GR-X1X0	Double act.,illum.,flat_off-button ext.
<input type="checkbox"/>	1		290090	DILM15-01 (110V/50HZ, 120V/50HZ)	Contactors 7,5kW/400V,AC-operated
<input type="checkbox"/>	1		138516	PK65SXTU-8S	PK65S + trip block Standard 8-65A

Parts list, e.g. for queries to Eaton Sales.



Sensors optimized for OEM applications

Machine builders need robust, reliable, and cost-effective sensors for a variety of challenging applications.

To meet those Eaton is your global partner.

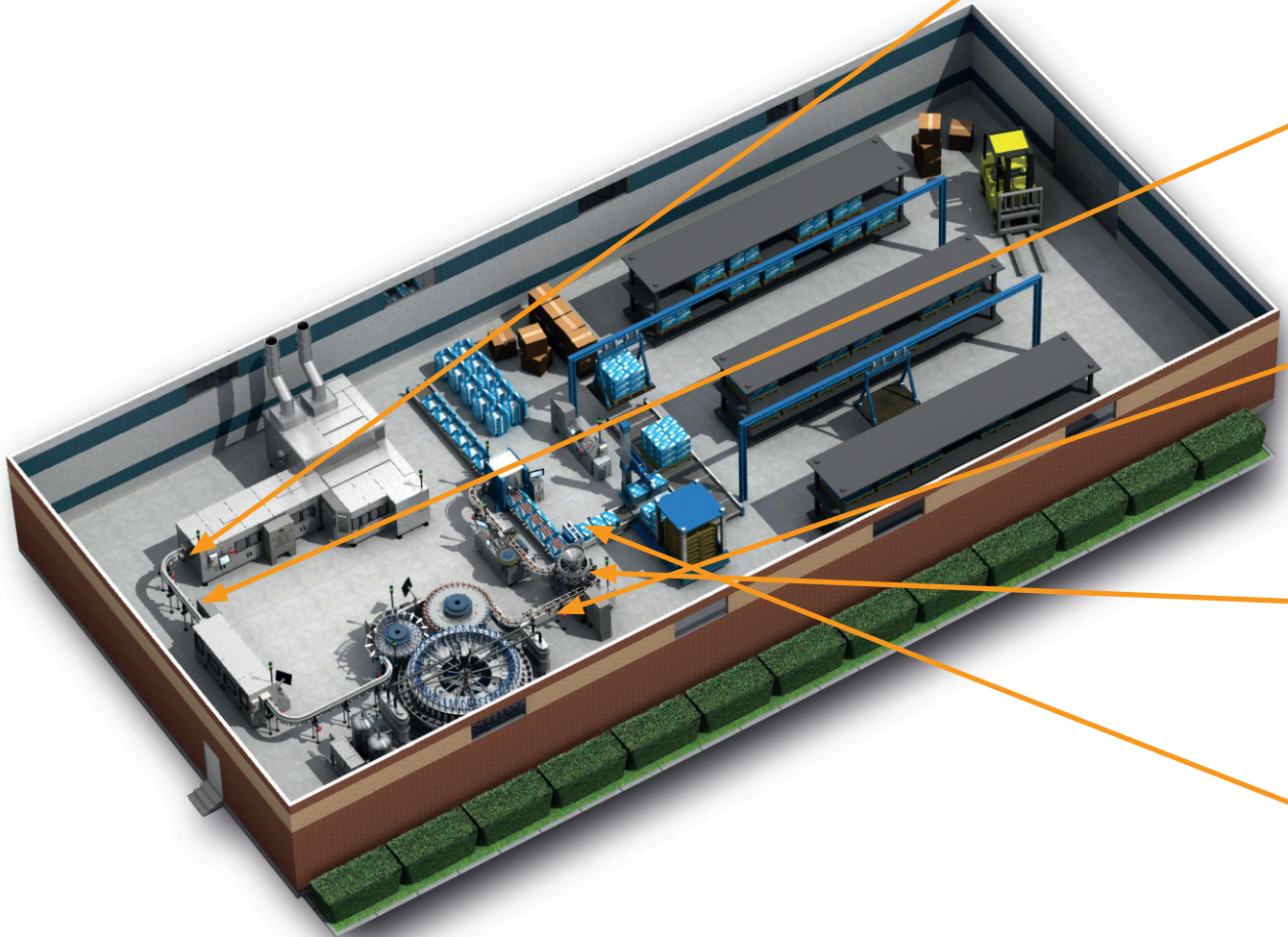

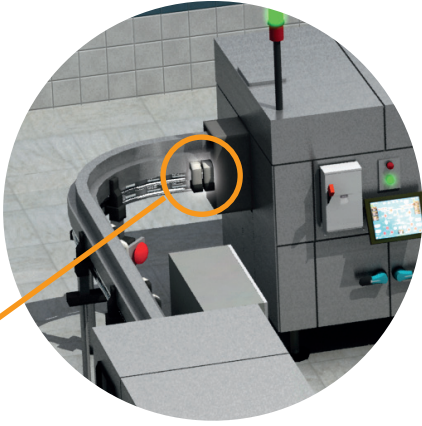

Molding

Injection blow molding machines transform raw plastic into molded bottles. These machines heat the plastic, inject it into a cavity, and expand the plastic to its final shape. Capacitive sensors and photoelectric sensors can be used to detect the level of plastic pellets in the input hopper; to verify tooling positions and count parts coming out of the molds; and can be used after the operation to verify correct bottle volume and dimensions at much lower cost and complexity than vision-based systems.



Transporting

Air transport moves product from one station to the next at incredible speed, all while a vacuum seal on open containers keeps bottles contaminant-free. Along the line, specialized photoelectric sensors with an ability to detect clear objects can be used to count bottles as they fly by, also looking for unusual gaps between adjacent products that might indicate a missing or dropped product.



Filling

Photoelectric sensors can be used to detect both bottle and filler positions and capacitive sensors or specialized photoelectric sensors can be used to confirm correct fluid fill levels.

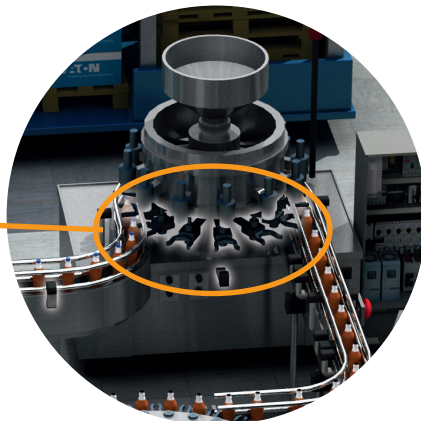

Capping

As the filled bottles are moved to the capping machine, photoelectric sensors detect bottle position, and capacitive sensors can be used to confirm correct fluid fill levels. Depending on the type of cap, photoelectric and/or inductive sensors can be used to inspect for correct cap placement and tightening. Once capped, the bottles are wrapped in a plastic seal that contains special UV dyes. As the bottles leave the machine, specialized UV-sensitive photoelectric sensors can be used to confirm the presence of the safety seal around the cap.



Packing

Bottles are batched into groupings of twelve, and moved over a cardboard box blank. The side of the cardboard is then folded up, around the product, to form the final product box. Photoelectric sensors can be used at this stage to count bottles during the batching process, to ensure that the cardboard box blank is present, and to verify the position of the batch as it is moved into place for the packing step. Sensors can also be used to verify that box sides have been folded up to the correct height, and to count finished packages moving on to a palletizer or a finished goods station.

Description

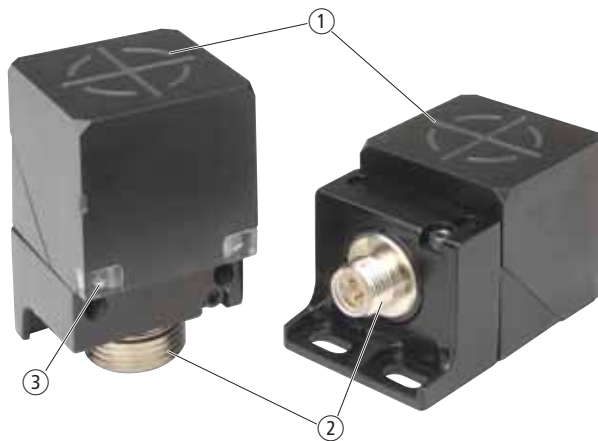

- ① Adjustable Sensing Head for Top- and Side-Sensing.
- ② Plug connector M12.
- ③ Two LED status indications.

Short Description

Sensor E52 Cube from Eaton is a powerful inductive proximity sensor. It provides a long sensing range in a compact, standard-conformant enclosure. The outputs of this series are self-configuring as PNP or NPN, without user interaction. The E52 features additional outputs for various connection types to cover many applications with just a few models. Separate indicator lights for voltage and output signal simplify installation and fault retrieval. Five different mounting methods make these sensors exceptionally versatile. The E52 Cube has been developed specially for demanding applications, for example in car production, in bulk material plants and in metal-processing industries.

Product Features

- Large measuring range up to 40 mm.
- Four-wire models feature additional outputs (1 × N/C, 1 × N/O).
- Four-wire DC models feature an automatic configuration function for independent NPN/PNP selection.
- Robust design featuring vibration and impact-absorbing potting compound
- Ideal for extreme temperatures or high pressure washdown environments.

Approvals



Ordering

	Rated operational voltage U_e	Rated switching distance S_n mm	Type of mounting	Switching type	For connection of:	Contact configuration N/O = normally open contact N/C = normally closed contact	Material	Part no. Article no.	Price see price list	Std. pack
E52-Serie										
4-wire 40 x 40 x 40 mm										
	10 – 48 V DC	15	Flush	NPN PNP	Plug-in connection M12 x 1	1 NC/1 N/O	Zinc/Insulated material	E520-DL15SAD01 135804		1 off
		15	Non-flush					E520-DL15UAD01 135805		
		20	Flush					E520-DL20SAD01 135806		
		20	Non-flush					E520-DL20UAD01 135807		
		25	Non-flush					E520-DL25UAD01 135808		
		30	Non-flush					E520-DL30UAD01 135809		
		35	Non-flush					E520-DL35UAD01 135810		
		40	Non-flush					E520-DL40UAD01 135811		

Information relevant for export to North America



Product Standards	UL 508; CSA-C22.2 No. 14; IEC60947-5-2; CE marking
UL File No.	E166051
UL CCN	NRKH, NRKH7
CSA File No.	UL report applies to both Canada and US
CSA Class No.	–
NA Certification	UL listed, certified by UL for use in Canada
Max. Voltage Rating	48 V DC
Degree of Protection	IEC: IP68; UL Type 4, 4X, 6, 6P, 12, 13

Engineering

Circuit diagrams

E52...

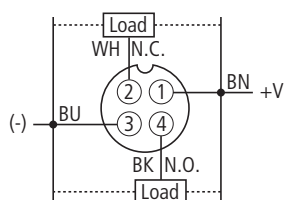

Through autoconfiguration connectable to both +V or (-).

Dimensions

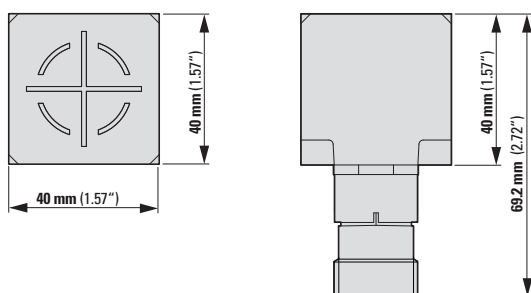

Technical data

			E52-Serie
General			
Standards			IEC/EN 60947-5-2
Ambient temperature		°C	- 40 - + 70
Protection type			IP67
Mechanical shock resistance		g	30 Shock duration 11 ms
Characteristics			
Repetition accuracy of S_n		%	2
Temperature drift of S_n		%	10
Switching hysteresis of S_n		%	15
Rated operational voltage		U_e	10 – 48 V DC
Operating current in the switched state at 24 V DC	I_b	mA	25
Maximum load current	I_e	mA	300
Voltage drop at I_e	U_d	V	2.5
Switching Frequency		Hz	100
Residual current through the load in the blocked state at 230 V AC and 24 V DC	I_r	mA	0.15
Switching state display		LED	Red
Operating voltage display		LED	Green
Protective functions			Short-circuit protective device Protection against polarity reversal Protection against wire breakage
Connection			4-wire
Design (outer dimensions)		mm	40 x 40 x 40
For connection of:			Plug-in connection M12 x 1
Material			Zinc/Insulated material
Surface			Zinc alloy
Notes			Further technical data can be found in the Online Catalog at http://de.ecat.moeller.net

Description

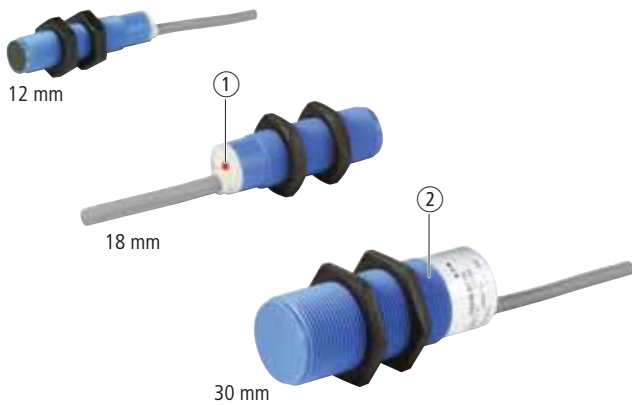

- ① LED for output status.
- ② Corrosion-resistant PBT Housing

Short Description

Cylinder design

Tubular Inductive Proximity Sensors by Eaton's electrical business are constructed of corrosion-resistant PBT insulated material. They are ideally suited for wash down applications such as those found in food processing plants. They are available in 12 mm, 18 mm and 30 mm diameters. Screened sensors can be embedded in metallic surfaces.

Product Features

Cylinder design

- Versions for 2-conductor AC voltage or 3-conductor DC voltage.
- Threaded tubular housings in three diameters allow easy integration into new and existing applications
- Nonmetallic construction offers excellent resistance to corrosion
- All models feature an output signal indicator light.

Approvals



- ① Sensor head fitted for lateral detection. Can be rotated 90°.
- ② Non-metal housing is corrosion-resistant.

Short Description

Rectangular design

These sensors from Eaton's electrical business feature PBT resin housings for high resistance to corrosion. The housing is sized to offer a direct replacement for standard limit switches. The unique sensing head is factory assembled for top sensing, but can be easily converted in the field to any one of four side sensing positions. Models are available with sensing ranges from 15 mm to 40 mm. The sensors can be wired for N/O or N/C operation.







Product Features

Rectangular design

- Nonmetallic housing offers excellent resistance to corrosion.
- Same form factor and design as standard limit switches for easy retrofit.
- Sensor head features five sensing positions (top and all four sides) that can be easily changed in the field.
- Long sensing ranges up to 40 mm.

Approvals

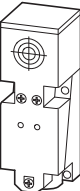

	Design (outer dimensions) mm	Rated operational voltage U_e	Rated switching distance S_n mm	Type of mounting	Switching type	Contact configuration N/O = normally open contact N/C = normally closed contact	Part no.	Article no.	Price see price list	Std. pack	
E55-Serie											
2-wire 2 m connection cable Insulated material											
	M12 x 1	20 - 250 V AC	2	Flush	-	1 N/O 1 NC	E55CAL12A2 E55CBL12A2	135816 135834	1 off		
			4	Non-flush	-	1 N/O 1 NC	E55CAL12A2E E55CBL12A2E	135817 135835			
	M18 x 1	20 - 250 V AC	5	Flush	-	1 N/O 1 NC	E55CAL18A2 E55CBL18A2	135822 135839			
			8	Non-flush	-	1 N/O 1 NC	E55CAL18A2E E55CBL18A2E	135823 135840			
	M30 x 1.5	20 - 250 V AC	10	Flush	-	1 N/O 1 NC	E55CAL30A2 E55CBL30A2	135828 135844			
			15	Non-flush	-	1 N/O 1 NC	E55CAL30A2E E55CBL30A2E	135829 135845			
3-wire 2 m connection cable Insulated material											
	M12 x 1	10 - 30 V DC	2	Flush	NPN PNP PNP	1 N/O 1 N/O 1 NC	E55CAL12T110 E55CAL12T111 E55CBL12T111	135818 135820 135837	1 off		
			4	Non-flush	NPN PNP NPN PNP	1 N/O 1 N/O 1 NC 1 NC	E55CAL12T110E E55CAL12T111E E55CBL12T110E E55CBL12T111E	135819 135821 135836 135838			
	M18 x 1	10 - 30 V DC	5	Flush	NPN PNP NPN	1 N/O 1 N/O 1 NC	E55CAL18T110 E55CAL18T111 E55CBL18T110	135824 135826 135841			
			8	Non-flush	NPN PNP NPN PNP	1 N/O 1 N/O 1 NC 1 NC	E55CAL18T110E E55CAL18T111E E55CBL18T110E E55CBL18T111E	135825 135827 135842 135843			
3-wire 2 m connection cable Insulated material											
	M30 x 1.5	10 - 30 V DC	10	Flush	NPN PNP NPN PNP	1 N/O 1 N/O 1 NC 1 NC	E55CAL30T110 E55CAL30T111 E55CBL30T110 E55CBL30T111	135830 135832 135846 135848		1 off	
			15	Non-flush	NPN PNP NPN PNP	1 N/O 1 N/O 1 NC 1 NC	E55CAL30T110E E55CAL30T111E E55CBL30T110E E55CBL30T111E	135831 135833 135847 135849			
2-wire Screw terminal Insulated material											
	40 x 40 x 118	35 - 250 V AC	15	Flush	-	1 P	E55BLT1C	135812	1 off		
			20	Non-flush	-	1 P	E55BLT1D	135813			
			30	Non-flush	-	1 P	E55BLT1E	135814			
			40	Non-flush	-	1 P	E55BLT1F	135815			

Technical data

		E55C...L12A	E55C...L18A	E55C...L30A	E55C...L12T E55C...L12T...E
General					
Standards		IEC/EN 60947-5-2			
Ambient temperature	°C	- 25 - + 70	- 25 - + 70	- 25 - + 70	- 25 - + 70
Protection type		IP66	IP66	IP66	IP66
Mechanical shock resistance	g	30 Shock duration 11 ms			
Characteristics					
Repetition accuracy of S _n	%	10	10	10	10
Temperature drift of S _n	%	10	10	10	10
Switching hysteresis of S _n	%	20	20	20	20
Rated operational voltage	U _e	20 - 250 V AC	20 - 250 V AC	20 - 250 V AC	10 - 30 V DC
Residual ripple of U _e	%	10	10	10	10
Maximum load current	I _e mA	150	150	150	200
Voltage drop at I _e	U _d V	10	10	10	8
Switching Frequency	Hz	25	25	25	2000 1000
Switching state display	LED	Red	Red	Red	Red
Protective functions					Short-circuit protective device Protection against polarity reversal
Connection		2-wire	2-wire	2-wire	3-wire
Style					
Design (outer dimensions)	mm	M12 x 1	M18 x 1	M30 x 1.5	M12 x 1
For connection of:		2 m connection cable			
Material		Insulated material			

		E55C...L18T E55C...L18T...E	E55C...L30T E55C...L30T...E	E55BLT...
General				
Standards		IEC/EN 60947-5-2		
Ambient temperature	°C	- 25 - + 70	- 25 - + 70	- 25 - + 70
Protection type		IP66	IP66	IP67
Mechanical shock resistance	g	30 Shock duration 11 ms		
Characteristics				
Repetition accuracy of S _n	%	10	10	10
Temperature drift of S _n	%	10	10	10
Switching hysteresis of S _n	%	20	20	20
Rated operational voltage	U _e	10 - 30 V DC	10 - 30 V DC	35 - 250 V AC
Residual ripple of U _e	%	10	10	10
Maximum load current	I _e mA	200	200	400
Voltage drop at I _e	U _d V	8	8	8
Switching Frequency	Hz	1000 500	300 150	25
Switching state display	LED	Red	Red	Red
Protective functions		Short-circuit protective device Protection against polarity reversal	Short-circuit protective device Protection against polarity reversal	Short-circuit protective device
Connection		3-wire	3-wire	2-wire
Style				
Design (outer dimensions)	mm	M18 x 1	M30 x 1.5	40 x 40 x 118
For connection of:		2 m connection cable		Screw terminal
Material		Insulated material		Insulated material

Notes

Further technical data can be found in the Online Catalog at <http://de.ecat.moeller.net>

Engineering

E55CAL...AZ, E55CBL...A2
E55CAL...A2E, E55CBL...A2E

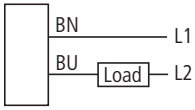

E55BL...

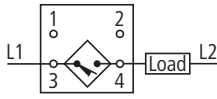

E55CAL...110, E55CBL...110
E55CAL...110E, E55CBL...110E

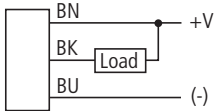

E55BL...

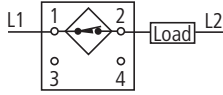

E55CAL...111, E55CBL...111E
E55CAL...111, E55CBL...111E

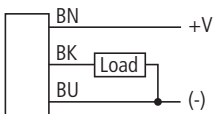

Note:

Switches are supplied configured as N/O. Can be built-in changed over to NC.

Dimensions

E55CAL12...
E55CBL12...

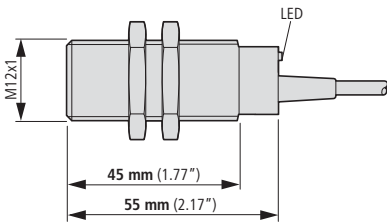

E55BL...

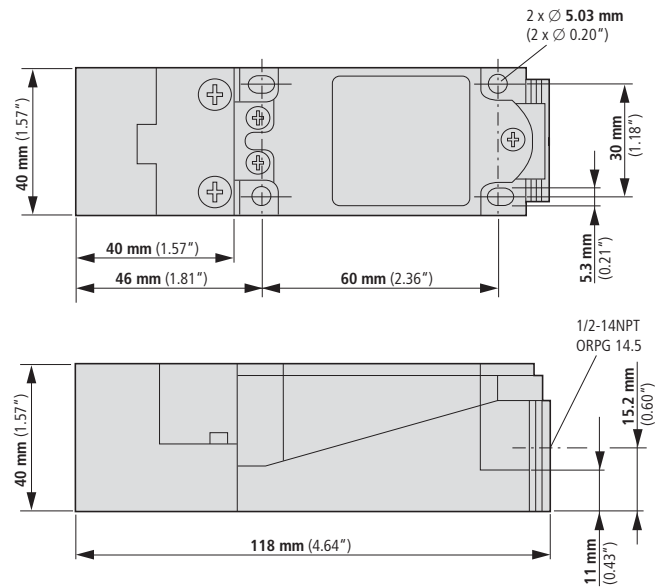

E55CAL18...
E55CBL18...

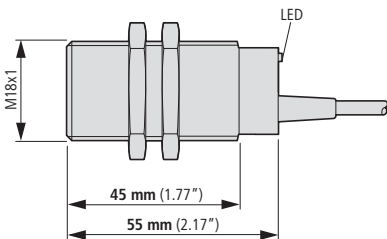

E55CAL30...
E55CBL30...

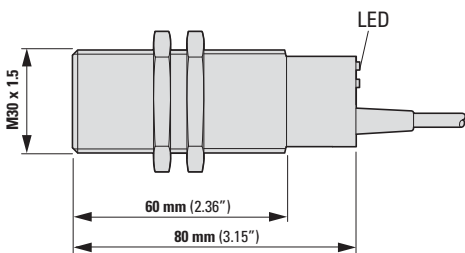

Description



① Indicator lights for current and output status.

Short Description

Eaton's E56 sensors are powerful inductive proximity sensors. The E56 Pancake provides greater sensing ranges than other inductive sensor package types. They are easy to wire and feature self-configuring complementary outputs, which automatically detect an NPN or PNP connection and configure the sensor accordingly without user interaction. Indicator lights for power and output state simplify troubleshooting compared to sensors with only an output indicator. These convenience features and their high performance make the E56 Pancake sensors ideal for applications in which a rugged design and a long range are required.



Product Features

- Large measuring with range up to 100 mm.
- Three sizes for all application scenarios; max. range 50, 70 or 100 mm.
- Complementary outputs (1 × N/C, 1 × N/O) on models with four-wire connection.
- Models with DC voltage four-wire connection feature an automatic configuration function for independent switchover between NPN and PNP.
- Robust design featuring vibration and impact-absorbing potting compound
- Ideal for extreme temperatures or high pressure washdown environments.

Approvals



Ordering

	Con- nection	Design (outer dimensions) mm	Rated operational voltage U _e	Rated switching distance S _n mm	Type of moun- -ting	Switch- -ing type	For connection of:	Contact configuration N/O = normally open contact N/C = normally closed contact	Part no. Article no.	Price see price list	Std. pack
E56-Serie											
Insulated material											
	4-wire	79 x 79 x 39	10 – 42 V DC	40	Flush	NPN	Plug-in connection M12 x 1	1 NC/1 N/O	E56ADL40SAD01 136234		1 off
		79 x 79 x 39		40	Non- flush	NPN		1 NC/1 N/O			
		109 x 110 x 41		70	Non- flush	NPN		1 NC/1 N/O	E56BDL70UAD01 136236		
		171.5 x 171.5 x 67.4		100	Non- flush	NPN		1 NC/1 N/O			

Information relevant for export to North America



Product Standards	UL 508; CSA-C22.2 No. 14; IEC60947-5-2; CE marking
UL File No.	E166051
UL CCN	NRKH, NRKH7
CSA File No.	UL report applies to both Canada and US
CSA Class No.	-
NA Certification	UL listed, certified by UL for use in Canada
Max. Voltage Rating	48 V DC
Degree of Protection	IEC: IP67, IP69K; UL/CSA Type: 4, 4x, 6, 6P, 12, 13

Engineering

Circuit diagrams

E56...

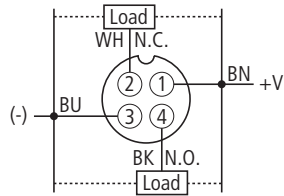

Through autoconfiguration connectable to both +V or (-).

Dimensions

E56ADL40...

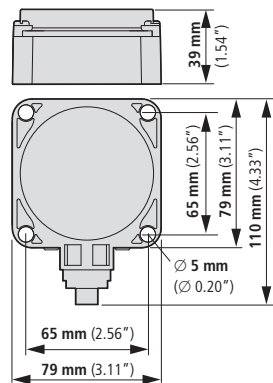

E56BDL70...

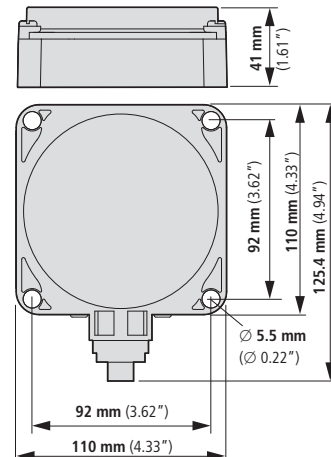

E56CDL100...

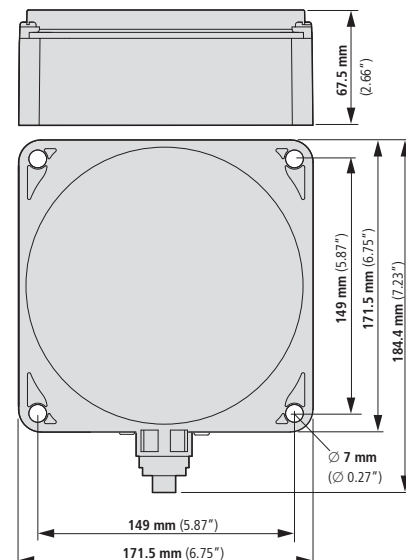

Technical data

			E56ADL40S	E56ADL40U	E56BDL70U	E56CDL100U
General						
Standards			IEC/EN 60947-5-2			
Ambient temperature		°C	- 25 - + 70	- 25 - + 70	- 25 - + 70	- 25 - + 70
Protection type			IP67	IP67	IP67	IP67
Characteristics						
Repetition accuracy of S_n		%	2	2	2	2
Temperature drift of S_n		%	10	10	10	10
Switching hysteresis of S_n		%	15	15	15	15
Rated operational voltage		U_e	10 – 42 V DC	10 – 42 V DC	10 – 42 V DC	10 – 42 V DC
Operating current in the switched state at 24 V DC	I_b	mA	25	25	25	25
Maximum load current	I_e	mA	300	300	300	300
Voltage drop at I_e	U_d	V	2.5	2.5	2.5	2.5
Switching Frequency		Hz	100	100	20	20
Min. load current	I_e	mA	1	1	1	1
Residual current through the load in the blocked state at 230 V AC and 24 V DC	I_r	mA	0.15	0.15	0.15	0.15
Switching state display		LED	Red	Red	Red	Red
Operating voltage display		LED	Green	Green	Green	Green
Protective functions			Short-circuit protective device Protection against polarity reversal			
Connection			4-wire	4-wire	4-wire	4-wire
Style						
Design (outer dimensions)		mm	79 x 79 x 39	79 x 79 x 39	109 x 110 x 41	171.5 x 171.5 x 67.4
For connection of:			Plug-in connection M12 x 1			
Material			Insulated material	Insulated material	Insulated material	Insulated material
Surface			PPS	PPS	PPS	PPS

Notes

Further technical data can be found in the Online Catalog at <http://de.ecat.moeller.net>

Description



- ① Outputs with function display on all models.
- ② All models with M12 plug connector or cable (2 m).
- ③ Versions for flush or non-flush mounting available.

Short Description

Eaton's proximity sensors of the Global series have been developed specially for OEM series production. The sensors feature only the functions required for reliable operation. This means that you do not pay for additional, unnecessary functions but get the performance and features you expect from a sensor. Our DC versions feature a short-circuit protective device and a rating of up to 2000 measuring cycles per second. The outputs of all models are equipped with a function display. The Global model series includes models with various diameters from 8 to 30 mm, making it truly versatile in installation. Versions with various ranges are also available. The proximity sensors Global are DC or AC units with 2- or 3-wire, NPN or PNP configuration. Versions for hard-wiring or with M12 plug connector are available. The DC versions have a rated load current of 100 mA, the AC versions of 200 mA.

Product Features







- The Global Proximity Line features solid performance and a basic feature set for reliable, cost-effective sensing.
- Available in a variety of sizes to fit in all of your applications: 8 mm, 12 mm, 18 mm and 30 mm diameters.
- The input voltage of the DC versions is 10 – 30 V DC in 2- and 3-wire configuration (PNP and NPN).
- The input voltage of the AC voltage variants is 2-AC 20...250 V.
- The operating frequency of the DC versions is 2 kHz.
- Versions for flush or non-flush installation available.
- Connection through cable (2 meters) or M12 plug connector
- The DC versions feature a short-circuit protective device.

Approvals



cCSAus

Ordering







	Rated operational voltage U_e	Rated switching distance S_n mm	Type of mounting	Switching type	For connection of:	Contact configuration N/O = normally open contact N/C = normally closed contact	Part no. Article no.	Price see price list	Std. pack
E57 Global series									
2-wire Metal									
M12 x 1									
	10 - 30 V DC	2	Flush	-	2 m connection cable	1 N/O	E57-12GS02-D 135883	1 off  	
					Plug-in connection M12 x 1	1 N/O	E57-12GS02-DBB 135884		
		4	Non-flush	2 m connection cable	1 N/O	E57-12GU04-D 135891			
				2 m connection cable	1 NC	E57-12GU04-D1 135892			
		8	Non-flush	Plug-in connection M12 x 1	1 N/O	E57-12GU04-DBB 135893			
				2 m connection cable	1 NC	E57-12GE08-D1 135872			
		8	Non-flush	Plug-in connection M12 x 1	1 NC	E57-12GE08-D1DB 135873			
				Plug-in connection M12 x 1	1 N/O	E57-12GE08-DBB 135874			
	8	Non-flush	2 m connection cable	1 N/O	E57-12GE08-D 135871				
			20 - 250 V AC	2	Flush	-	2 m connection cable		1 N/O
	Plug-in connection M12 x 1	1 N/O					E57-12GS02-AAB 135880		
	4	Non-flush		2 m connection cable	1 N/O	E57-12GU04-A 135887			
				Plug-in connection M12 x 1	1 N/O	E57-12GU04-AAB 135888			
	M18 x 1								
	10 - 30 V DC	5	Flush	-	2 m connection cable	1 N/O	E57-18GS05-D 135929	1 off  	
					Plug-in connection M12 x 1	1 N/O	E57-18GS05-DBB 135930		
		8	Non-flush	2 m connection cable	1 N/O	E57-18GU08-D 135937			
				Plug-in connection M12 x 1	1 N/O	E57-18GU08-DBB 135938			
		16	Non-flush	2 m connection cable	1 N/O	E57-18GE16-D 135917			
				2 m connection cable	1 NC	E57-18GE16-D1 135918			
		16	Non-flush	Plug-in connection M12 x 1	1 NC	E57-18GE16-D1DB 135919			
				Plug-in connection M12 x 1	1 N/O	E57-18GE16-DBB 135920			
	20 - 250 V AC	5	Flush	-	2 m connection cable	1 N/O	E57-18GS05-A 135925		
					Plug-in connection M12 x 1	1 N/O	E57-18GS05-AAB 135926		
		8	Non-flush	2 m connection cable	1 N/O	E57-18GU08-A 135933			
				Plug-in connection M12 x 1	1 N/O	E57-18GU08-AAB 135934			
		16	Non-flush	Plug-in connection M12 x 1	1 N/O	E57-18GE16-AAB 135916			

Information relevant for export to North America



Product Standards
UL File No.
UL CCN
CSA File No.
CSA Class No.
NA Certification
Max. Voltage Rating
Degree of Protection

UL 508; CSA-C22.2 No. 14; IEC60947-5-2; CE marking
CSA report applies to both Canada and US
-
224447
4652-04 / 4652-84
CSA certified
250 V AC, 30 V DC
IEC: IP67, IP69K; UL/CSA Type: -









Rated operational voltage U_e	Rated switching distance S_n mm	Type of mounting	Switching type	For connection of:	Contact configuration N/O = normally open contact N/C = normally closed contact	Part no. Article no.	Price see price list	Std. pack
E57 Global series								
2-wire Metal								
M30 x 1.5								
	10 - 30 V DC	10	Flush	-	2 m connection cable	1 N/O	E57-30GS10-D 135973	1 off  
					2 m connection cable	1 NC	E57-30GS10-D1 135974	
					Plug-in connection M12 x 1	1 N/C	E57-30GS10-D1DB 135975	
		Plug-in connection M12 x 1	1 N/O	E57-30GS10-DDB 135976				
		2 m connection cable	1 N/O	E57-30GU15-D 135983				
		Plug-in connection M12 x 1	1 N/O	E57-30GU15-DDB 135984				
	25	Non-flush	-	2 m connection cable	1 N/O	E57-30GE25-D 135961		
				2 m connection cable	1 N/C	E57-30GE25-D1 135962		
				Plug-in connection M12 x 1	1 NC	E57-30GE25-D1DB 135963		
		Plug-in connection M12 x 1	1 N/O	E57-30GE25-DDB 135964				
		10	Flush	-	2 m connection cable	1 N/O	E57-30GS10-A 135969	
					Plug-in connection M12 x 1	1 N/O	E57-30GS10-AAB 135970	
2 m connection cable	1 N/O				E57-30GU15-A 135979			
15	Non-flush	-	Plug-in connection M12 x 1	1 N/O	E57-30GU15-AAB 135980			
3-wire Stainless steel								
M8 x 1								
	10 - 30 V DC	1	Flush	NPN	2 m connection cable	1 N/O	E57-08GS01-C 135859	1 off  
					Plug-in connection M12 x 1	1 N/O	E57-08GS01-CDB 135860	
					2 m connection cable	1 N/O	E57-08GS01-G 135861	
		Plug-in connection M12 x 1	1 N/O	E57-08GS01-GDB 135862				
		2	Non-flush	NPN	2 m connection cable	1 N/O	E57-08GU02-C 135863	
					Plug-in connection M12 x 1	1 N/O	E57-08GU02-CDB 135864	
	2 m connection cable				1 N/O	E57-08GU02-G 135865		
	3	Flush	NPN	Plug-in connection M12 x 1	1 N/O	E57-08GU02-GDB 135866		
				NPN	2 m connection cable	1 NC	E57-08GBE03-C 135850	
					2 m connection cable	1 N/O	E57-08GE03-C 135851	
	PNP	Plug-in connection M12 x 1	1 N/O		E57-08GE03-CDB 135852			
		2 m connection cable	1 N/O	E57-08GE03-G 135853				
Plug-in connection M12 x 1		1 N/O	E57-08GE03-GDB 135854					

Information relevant for export to North America



Product Standards
UL File No.
UL CCN
CSA File No.
CSA Class No.
NA Certification
Max. Voltage Rating
Degree of Protection

UL 508; CSA-C22.2 No. 14; IEC60947-5-2; CE marking
CSA report applies to both Canada and US
-
224447
4652-04 / 4652-84
CSA certified
250 V AC, 30 V DC
IEC: IP67, IP69K; UL/CSA Type: -















	Rated operational voltage U_e	Rated switching distance S_n mm	Type of mounting	Switching type	For connection of:	Contact configuration N/O = normally open contact N/C = normally closed contact	Part no. Article no.	Price see price list	Std. pack	
E57 Global series										
3-wire										
M8 x 1, Stainless steel										
	10 - 30 V DC	6	Non-flush	NPN	2 m connection cable	1 N/O	E57-08GE06-C 135855		1 off  	
					Plug-in connection M12 x 1	1 N/O	E57-08GE06-CDB 135856			
				PNP	2 m connection cable	1 N/O	E57-08GE06-G 135857			
					Plug-in connection M12 x 1	1 N/O	E57-08GE06-GDB 135858			
M12 x 1, Metal										
	10 - 30 V DC	2	Flush	NPN	2 m connection cable	1 N/O	E57-12GS02-C 135881		1 off  	
					Plug-in connection M12 x 1	1 N/O	E57-12GS02-CDB 135882			
				PNP	2 m connection cable	1 N/O	E57-12GS02-G 135885			
					Plug-in connection M12 x 1	1 N/O	E57-12GS02-GDB 135886			
				4	NPN	2 m connection cable	1 N/O			E57-12GU04-C 135889
						Plug-in connection M12 x 1	1 N/O			E57-12GU04-CDB 135890
		PNP	2 m connection cable		1 N/O	E57-12GU04-G 135894				
			Plug-in connection M12 x 1		1 N/O	E57-12GU04-GDB 135895				
		5	NPN	2 m connection cable	1 N/O	E57-12GE05-C 135867				
				Plug-in connection M12 x 1	1 N/O	E57-12GE05-CDB 135868				
			PNP	2 m connection cable	1 N/O	E57-12GE05-G 135869				
				Plug-in connection M12 x 1	1 N/O	E57-12GE05-GDB 135870				
10	NPN		2 m connection cable	1 N/O	E57-12GE10-C 135875					
			Plug-in connection M12 x 1	1 N/O	E57-12GE10-CDB 135876					
	PNP	2 m connection cable	1 N/O	E57-12GE10-G 135877						
		Plug-in connection M12 x 1	1 N/O	E57-12GE10-GDB 135878						
M18 x 1, Metal										
	10 - 30 V DC	5	Flush	NPN	2 m connection cable	1 N/O	E57-18GS05-C 135927		1 off  	
					Plug-in connection M12 x 1	1 N/O	E57-18GS05-CDB 135928			
				PNP	2 m connection cable	1 N/O	E57-18GS05-G 135931			
					Plug-in connection M12 x 1	1 N/O	E57-18GS05-GDB 135932			
		8	NPN	2 m connection cable	1 N/O	E57-18GE08-C 135912				
				Plug-in connection M12 x 1	1 N/O	E57-18GE08-CDB 135913				
PNP	2 m connection cable	1 N/O	E57-18GE08-G 135914							
	Plug-in connection M12 x 1	1 N/O	E57-18GE08-GDB 135915							

Information relevant for export to North America



Product Standards
UL File No.
UL CCN
CSA File No.
CSA Class No.
NA Certification
Max. Voltage Rating
Degree of Protection

UL 508; CSA-C22.2 No. 14; IEC60947-5-2; CE marking
CSA report applies to both Canada and US
-
224447
4652-04 / 4652-84
CSA certified
250 V AC, 30 V DC
IEC: IP67, IP69K; UL/CSA Type: -

Rated operational voltage U_e	Rated switching distance S_n mm	Type of mounting	Switching type	For connection of:	Contact configuration N/O = normally open contact N/C = normally closed contact	Part no. Article no.	Price see price list	Std. pack			
E57 Global series											
3-wire											
M18 x 1 Metal											
	10 - 30 V DC	8	Non-flush	NPN	2 m connection cable	1 N/O	E57-18GU08-C 135935	1 off  			
					Plug-in connection M12 x 1	1 N/O	E57-18GU08-CDB 135936				
				PNP	2 m connection cable	1 N/O	E57-18GU08-G 135939				
					Plug-in connection M12 x 1	1 N/O	E57-18GU08-GDB 135940				
	18	Non-flush	NPN	2 m connection cable	1 N/O	E57-18GE18-C 135921	1 off  				
				Plug-in connection M12 x 1	1 N/O	E57-18GE18-CDB 135922					
			PNP	2 m connection cable	1 N/O	E57-18GE18-G 135923					
				Plug-in connection M12 x 1	1 N/O	E57-18GE18-GDB 135924					
3-wire											
M30 x 1.5 Metal											
	10 - 30 V DC	10	Flush	NPN	2 m connection cable	1 N/O		E57-30GS10-C 135971	1 off  		
					Plug-in connection M12 x 1	1 N/O		E57-30GS10-CDB 135972			
				PNP	2 m connection cable	1 N/O	E57-30GS10-G 135977				
					Plug-in connection M12 x 1	1 N/O	E57-30GS10-GDB 135978				
		15	Flush	NPN	2 m connection cable	1 N/O	E57-30GE15-C 135957	1 off  			
					Plug-in connection M12 x 1	1 N/O	E57-30GE15-CDB 135958				
				PNP	2 m connection cable	1 N/O	E57-30GE15-G 135959				
					Plug-in connection M12 x 1	1 N/O	E57-30GE15-GDB 135960				
	29	Non-flush	NPN	2 m connection cable	1 N/O	E57-30GU15-C 135981	1 off  				
					Plug-in connection M12 x 1	1 N/O				E57-30GU15-CDB 135982	
				PNP	2 m connection cable	1 N/O				E57-30GU15-G 135985	
					Plug-in connection M12 x 1	1 N/O				E57-30GU15-GDB 135986	
		Non-flush	NPN	2 m connection cable	1 N/O	E57-30GE29-C 135965				1 off  	
					Plug-in connection M12 x 1	1 N/O					E57-30GE29-CDB 135966
				PNP	2 m connection cable	1 N/O					E57-30GE29-G 135967
					Plug-in connection M12 x 1	1 N/O					E57-30GE29-GDB 135968

Information relevant for export to North America



Product Standards
UL File No.
UL CCN
CSA File No.
CSA Class No.
NA Certification
Max. Voltage Rating
Degree of Protection

UL 508; CSA-C22.2 No. 14; IEC60947-5-2; CE marking
CSA report applies to both Canada and US
-
224447
4652-04 / 4652-84
CSA certified
250 V AC, 30 V DC
IEC: IP67, IP69K; UL/CSA Type: -

Engineering

Circuit diagram

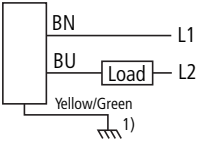
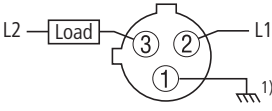
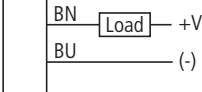
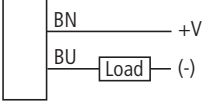
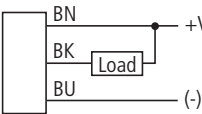
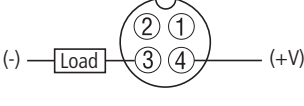
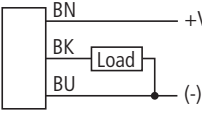
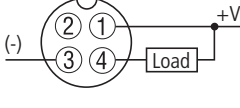
	2 m connection cable	Plug-in connection M12
AC, 2-wire	<p>E57...-A</p>  <p>¹⁾Built-in connected to enclosure (wiring optional)</p>	<p>E57...-AAB</p>  <p>¹⁾Built-in connected to enclosure (wiring optional)</p>
DC, 2-wire	<p>E57...-D E57...-D1</p> 	<p>E57...-DDB E57...-D1DB</p> 
DC, 3-wire, NPN	<p>E57...-C</p> 	<p>E57...-CDB</p> 
DC, 3-wire, PNP	<p>E57...-G</p> 	<p>E57...-GDB</p> 

Technical data

2-wire AC				E57-12...	E57-18...	E57-30...
General						
Standards				IEC/EN 60947-5-2		
Ambient temperature				- 25 - + 70	- 25 - + 70	- 25 - + 70
Protection type				IP67, IP69K	IP67, IP69K	IP67, IP69K
Mechanical shock resistance				30 Shock duration 11 ms		
Characteristics						
Repetition accuracy of S _n						
	...GS...		%	1	1	1
	...GU...		%	3	3	3
Temperature drift of S _n				10	10	10
Switching hysteresis of S _n				15	15	15
Rated operational voltage				20 - 250 V AC		
Maximum load current				I _e mA < 200		
Voltage drop at I _e				U _d V 8		
Switching Frequency				25 Hz		
Min. load current				I _e mA 5		
Residual current through the load in the blocked state at 230 V AC and 24 V DC				I _r mA 1.8		
Switching state display				LED Red		
Connection				2-wire		
Design (outer dimensions)				mm M12 x 1 / M18 x 1 / M30 x 1.5		
Material				Metal		

2-wire DC				E57-12...	E57-18...	E57-30...
General						
Standards				IEC/EN 60947-5-2		
Ambient temperature						
	...GS...		°C	- 25 - + 70	- 25 - + 70	- 25 - + 70
	...GU...		°C	- 25 - + 70	- 25 - + 70	- 25 - + 70
	...GE...		°C	- 0 - + 60	- 0 - + 60	- 0 - + 60
Protection type				IP67, IP69K	IP67, IP69K	IP67, IP69K
Mechanical shock resistance				30 Shock duration 11 ms		
Characteristics						
Repetition accuracy of S _n				2	2	2
Temperature drift of S _n				10	10	10
Switching hysteresis of S _n				15	15	15
Rated operational voltage				U _e 10 - 30 V DC		
Operating current in the switched state at 24 V DC						
	...GS...	I _b	mA	10	10	10
	...GU...	I _b	mA	20	20	20
	...GE...	I _b	mA	10	10	10
Maximum load current				I _e mA < 100		
Voltage drop at I _e				U _d V 6		
Switching Frequency						
	Flush		Hz	1000	1000	500
	Non-flush		Hz	1000	500	200
Min. load current				I _e mA 5		
Residual current through the load in the blocked state at 230 V AC and 24 V DC				I _r mA 0.01		
Switching state display				LED Red		
Connection				2-wire		
Design (outer dimensions)				mm M12 x 1 / M18 x 1 / M30 x 1.5		
Material				Metal		

Notes

Further technical data can be found in the Online Catalog at <http://de.ecat.moeller.net>

3-wire DC				E57-08...	E57-12...	E57-18...	E57-30...
General							
Standards				IEC/EN 60947-5-2			
Ambient temperature							
	...GS...		°C	- 25 - + 70	- 25 - + 70	- 25 - + 70	- 25 - + 70
	...GU...		°C	- 25 - + 70	- 25 - + 70	- 25 - + 70	- 25 - + 70
	...GB...		°C	- 25 - + 70	-	-	-
	...GE...		°C	- 0 - + 60	- 0 - + 60	- 0 - + 60	- 0 - + 60
Protection type				IP67, IP69K	IP67, IP69K	IP67, IP69K	IP67, IP69K
Mechanical shock resistance				30 Shock duration 11 ms			
Characteristics							
Repetition accuracy of S _n				1	1	1	1
Temperature drift of S _n				10	10	10	10
Switching hysteresis of S _n				15	15	15	15
Rated operational voltage				10 - 30 V DC	10 - 30 V DC	10 - 30 V DC	10 - 30 V DC
Residual ripple of U _e				10	10	10	10
Operating current in the switched state at 24 V DC							
	...GS...	I _b	mA	10	10	10	10
	...GU...	I _b	mA	10	20	20	20
	...GE...	I _b	mA	10	10	10	10
Maximum load current				< 100	< 100	< 100	< 100
Voltage drop at I _e				1.5	1.5	1.5	1.5
Switching Frequency							
	Flush		Hz	2000	2000	1000	500
	Non-flush		Hz	2000	1000	500	200
Residual current through the load in the blocked state at 230 V AC and 24 V DC				0.01	0.01	0.01	0.01
Switching state display				LED	LED	LED	LED
Protective functions				Short-circuit protective device Protection against polarity reversal Protection against wire breakage			
Connection				3-wire	3-wire	3-wire	3-wire
Design (outer dimensions)				mm	mm	mm	mm
				M8 x 1	M12 x 1	M18 x 1	M30 x 1.5
Material				Stainless steel	Metal	Metal	Metal

Dimensions

2 m connection cable

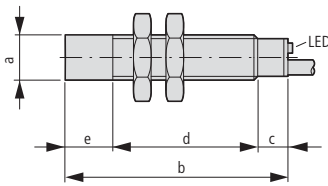

2	Typ	a	b		c		d		e		
			mm (inch)	mm (inch)	mm (inch)	mm (inch)	mm (inch)	mm (inch)			
20 - 250 V AC	E57-12GS02-A	M12 x 1	65 (2.56)	15 (0.59)	50 (1.97)	-	-	-	-	-	
	E57-12GU04-A	M12 x 1	60 (2.36)	15 (0.59)	42 (1.66)	8 (0.31)	-	-	-	-	
	E57-18GS05-A	M18 x 1	80 (3.15)	20 (0.79)	60 (2.36)	-	-	-	-	-	
	E57-18GU08-A	M18 x 1	80 (3.15)	20 (0.79)	48 (1.89)	12 (0.47)	-	-	-	-	
	E57-30GS10-A	M30	80 (3.15)	20 (0.79)	60 (2.36)	-	-	-	-	-	
	E57-30GU15-A	M30	80 (3.15)	20 (0.79)	45 (1.77)	15 (0.59)	-	-	-	-	
10 - 30 V DC	E57-12GS02-D	M12 x 1	50 (1.97)	-	50 (1.97)	-	-	-	-	-	
	E57-12GU04-D	M12 x 1	50 (1.97)	-	42 (1.66)	8 (0.31)	-	-	-	-	
	E57-12GU04-D1	M12 x 1	50 (1.97)	-	42 (1.66)	8 (0.31)	-	-	-	-	
	E57-12GE08-D	M12 x 1	50 (1.97)	-	42 (1.66)	8 (0.31)	-	-	-	-	
	E57-12GE08-D1	M12 x 1	50 (1.97)	-	42 (1.66)	8 (0.31)	-	-	-	-	
	E57-18GS05-D	M18 x 1	55 (2.17)	5 (0.20)	50 (1.97)	-	-	-	-	-	
	E57-18GU08-D	M18 x 1	55 (2.17)	5 (0.20)	38 (1.50)	12 (0.47)	-	-	-	-	
	E57-18GE16-D	M18 x 1	55 (2.17)	5 (0.20)	38 (1.50)	12 (0.47)	-	-	-	-	
	E57-18GE16-D1	M18 x 1	55 (2.17)	5 (0.20)	38 (1.50)	12 (0.47)	-	-	-	-	
	E57-30GS10-D	M30	55 (2.17)	5 (0.20)	50 (1.97)	-	-	-	-	-	
	E57-30GU15-D	M30	55 (2.17)	5 (0.20)	35 (1.38)	15 (0.59)	-	-	-	-	
	E57-30GE25-D	M30	55 (2.17)	5 (0.20)	35 (1.38)	15 (0.59)	-	-	-	-	
	E57-30GE25-D1	M30	55 (2.17)	5 (0.20)	35 (1.38)	15 (0.59)	-	-	-	-	
	3	Typ	a	b		c		d		e	
				mm (inch)	mm (inch)	mm (inch)	mm (inch)	mm (inch)	mm (inch)		
		10 - 30 V DC	E57-08GE03-C	M8 x 1	46 (1.81)	6 (0.24)	40 (1.57)	-	-	-	-
			E57-08GE06-C	M8 x 1	46 (1.81)	1 (0.04)	41 (1.61)	4 (0.16)	-	-	-
		E57-08GE03-G	M8 x 1	46 (1.81)	6 (0.24)	40 (1.57)	-	-	-	-	
		E57-08GE06-G	M8 x 1	46 (1.81)	1 (0.04)	41 (1.61)	4 (0.16)	-	-	-	
		E57-08GS01-C	M8 x 1	45 (1.77)	-	45 (1.77)	-	-	-	-	
		E57-08GS01-G	M8 x 1	45 (1.77)	-	45 (1.77)	-	-	-	-	
		E57-08GU02-C	M8 x 1	45 (1.77)	-	41 (1.61)	4 (0.16)	-	-	-	
		E57-08GU02-G	M8 x 1	45 (1.77)	-	41 (1.61)	4 (0.16)	-	-	-	
		E57-12GE05-C	M12 x 1	51 (2.00)	2 (0.08)	49 (1.93)	-	-	-	-	
E57-12GE05-G		M12 x 1	51 (2.00)	2 (0.08)	49 (1.93)	-	-	-	-		
E57-12GE10-C		M12 x 1	50.5 (1.99)	1.7 (0.07)	41 (1.61)	7.8 (0.31)	-	-	-		
E57-12GE10-G		M12 x 1	50.5 (1.99)	1.7 (0.07)	41 (1.61)	7.8 (0.31)	-	-	-		
E57-12GS02-C		M12 x 1	50 (1.97)	-	50 (1.97)	-	-	-	-		
E57-12GS02-G		M12 x 1	50 (1.97)	-	50 (1.97)	-	-	-	-		
E57-12GU04-C		M12 x 1	50 (1.97)	-	42 (1.66)	8 (0.31)	-	-	-		
E57-12GU04-G		M12 x 1	50 (1.97)	-	42 (1.66)	8 (0.31)	-	-	-		
E57-18GE08-C		M18 x 1	67.5 (2.66)	2.5 (0.10)	65 (2.56)	-	-	-	-		
E57-18GE08-G		M18 x 1	65.5 (2.58)	2.5 (0.10)	65 (2.56)	-	-	-	-		
E57-18GE18-C		M18 x 1	66 (2.60)	2.5 (0.10)	52 (2.05)	11.5 (0.45)	-	-	-		
E57-18GE18-G		M18 x 1	66 (2.60)	2.5 (0.10)	52 (2.05)	11.5 (0.45)	-	-	-		
E57-18GS05-C		M18 x 1	55 (2.17)	5 (0.20)	50 (1.97)	-	-	-	-		
E57-18GS05-G		M18 x 1	55 (2.17)	5 (0.20)	50 (1.97)	-	-	-	-		
E57-18GU08-C	M18 x 1	55 (2.17)	5 (0.20)	38 (1.50)	12 (0.47)	-	-	-			
E57-18GU08-G	M18 x 1	55 (2.17)	5 (0.20)	38 (1.50)	12 (0.47)	-	-	-			
E57-30GE15-C	M30	69 (2.72)	5 (0.20)	64 (2.52)	-	-	-	-			
E57-30GE15-G	M30	69 (2.72)	5 (0.20)	64 (2.52)	-	-	-	-			
E57-30GE29-C	M30	83 (3.27)	5 (0.20)	64 (2.52)	15 (0.59)	-	-	-			
E57-30GE29-G	M30	83 (3.27)	5 (0.20)	64 (2.52)	15 (0.59)	-	-	-			
E57-30GS10-C	M30	55 (2.17)	5 (0.20)	50 (1.97)	-	-	-	-			
E57-30GS10-G	M30	55 (2.17)	5 (0.20)	50 (1.97)	-	-	-	-			
E57-30GU15-C	M30	55 (2.17)	5 (0.20)	35 (1.38)	15 (0.59)	-	-	-			
E57-30GU15-G	M30	55 (2.17)	5 (0.20)	35 (1.38)	15 (0.59)	-	-	-			

Plug-in connection M12 x 1

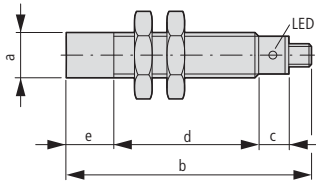

2	Typ	a	b	c	d	e
20 - 250 V AC	E57-12GS02-AAB	M12 x 1	68 (2.68)	16 (0.63)	42 (1.66)	-
	E57-12GU04-AAB	M12 x 1	68 (2.68)	16 (0.63)	34 (1.34)	8 (0.31)
	E57-18GE16-AAB	M18 x 1	94 (3.70)	20 (0.79)	48 (1.89)	12 (0.47)
	E57-18GS05-AAB	M18 x 1	91 (3.58)	20 (0.79)	60 (2.36)	-
	E57-18GU08-AAB	M18 x 1	91 (3.58)	20 (0.79)	48 (1.89)	12 (0.47)
	E57-30GS10-AAB	M30	80 (3.15)	20 (0.79)	60 (2.36)	-
	E57-30GU15-AAB	M30	91 (3.58)	20 (0.79)	45 (1.77)	15 (0.59)
10 - 30 V DC	E57-12GS02-DDB	M12 x 1	69 (2.72)	16 (0.63)	42 (1.66)	-
	E57-12GU04-DDB	M12 x 1	68 (2.68)	16 (0.63)	34 (1.34)	8 (0.31)
	E57-12GE08-DDB	M12 x 1	68 (2.68)	16 (0.63)	34 (1.34)	8 (0.31)
	E57-12GE08-D1DB	M12 x 1	68 (2.68)	10 (0.39)	50 (1.97)	8 (0.31)
	E57-18GS05-DDB	M18 x 1	76 (2.99)	15 (0.59)	61 (2.40)	-
	E57-18GU08-DDB	M18 x 1	80 (3.15)	15 (0.59)	49 (1.93)	12 (0.47)
	E57-18GE16-DDB	M18 x 1	79 (3.11)	15 (0.59)	52 (2.05)	12 (0.47)
	E57-18GE16-D1DB	M18 x 1	79 (3.11)	15 (0.59)	52 (2.05)	12 (0.47)
	E57-30GS10-DDB	M30	75 (2.95)	15 (0.59)	60 (2.36)	-
	E57-30GU15-DDB	M30	79 (3.11)	15 (0.59)	45 (1.77)	15 (0.59)
	E57-30GE25-DDB	M30	78 (3.07)	15 (0.59)	48 (1.89)	15 (0.59)
	E57-30GE25-D1DB	M30	78 (3.07)	15 (0.59)	48 (1.89)	15 (0.59)

3	Typ	a	b	c	d	e
10 - 30 V DC	E57-08GE03-CDB	M8 x 1	71 (2.80)	26 (1.02)	36 (1.42)	-
	E57-08GE03-CNB	M8 x 1	61 (2.40)	19 (0.75)	42 (1.66)	-
	E57-08GE03-GDB	M8 x 1	71 (2.80)	26 (1.02)	35 (1.38)	-
	E57-08GE03-GNB	M8 x 1	61 (2.40)	19 (0.75)	42 (1.66)	-
	E57-08GE06-CDB	M8 x 1	71 (2.80)	25 (0.98)	31 (1.22)	4 (0.16)
	E57-08GE06-GDB	M8 x 1	71 (2.80)	25 (0.98)	31 (1.22)	4 (0.16)
	E57-08GS01-CDB	M8 x 1	70 (2.76)	21 (0.83)	49 (1.93)	-
	E57-08GS01-GDB	M8 x 1	70 (2.76)	21 (0.83)	49 (1.93)	-
	E57-08GU02-CDB	M8 x 1	70 (2.76)	21 (0.83)	45 (1.77)	4 (0.16)
	E57-08GU02-GDB	M8 x 1	70 (2.76)	21 (0.83)	45 (1.77)	4 (0.16)
	E57-12GE05-CDB	M12 x 1	69 (2.72)	24 (0.94)	45 (1.77)	-
	E57-12GE05-GDB	M12 x 1	69 (2.72)	24 (0.94)	45 (1.77)	-
	E57-12GE10-CDB	M12 x 1	68.5 (2.70)	10.3 (0.41)	36 (1.42)	7.8 (0.31)
	E57-12GE10-GDB	M12 x 1	68.5 (2.70)	10.3 (0.41)	36 (1.42)	7.8 (0.31)
	E57-12GS02-CDB	M12 x 1	68 (2.68)	16 (0.63)	52 (2.05)	-
	E57-12GS02-GDB	M12 x 1	68 (2.68)	16 (0.63)	52 (2.05)	-
	E57-12GU04-CDB	M12 x 1	68 (2.68)	20 (0.79)	31 (1.22)	8 (0.31)
	E57-12GU04-GDB	M12 x 1	68 (2.68)	20 (0.79)	31 (1.22)	8 (0.31)
	E57-18GE08-CDB	M18 x 1	80 (3.15)	6 (0.24)	49 (1.93)	-
	E57-18GE08-GDB	M18 x 1	80 (3.15)	16 (0.63)	49 (1.93)	-
	E57-18GE18-CDB	M18 x 1	79 (3.11)	6 (0.24)	37 (1.46)	12 (0.47)
	E57-18GE18-GDB	M18 x 1	79 (3.11)	6 (0.24)	37 (1.46)	12 (0.47)
	E57-18GS05-CDB	M18 x 1	76 (2.99)	15 (0.59)	61 (2.40)	-
	E57-18GS05-GDB	M18 x 1	76 (2.99)	15 (0.59)	61 (2.40)	-
	E57-18GU08-CDB	M18 x 1	76 (2.99)	15 (0.59)	49 (1.93)	12 (0.47)
	E57-18GU08-GDB	M18 x 1	80 (3.15)	15 (0.59)	49 (1.93)	12 (0.47)
	E57-30GS10-CDB	M30	79 (3.11)	15 (0.59)	60 (2.36)	-
	E57-30GS10-GDB	M30	75 (2.95)	15 (0.59)	60 (2.36)	-
	E57-30GE15-CDB	M30	80 (3.15)	16 (0.63)	49 (1.93)	-
	E57-30GE15-GDB	M30	80 (3.15)	16 (0.63)	49 (1.93)	-
	E57-30GE29-CDB	M30	95 (3.74)	16 (0.63)	49 (1.93)	15 (0.59)
	E57-30GE29-GDB	M30	95 (3.74)	16 (0.63)	49 (1.93)	15 (0.59)
	E57-30GU15-CDB	M30	75 (2.95)	15 (0.59)	45 (1.77)	15 (0.59)
	E57-30GU15-GDB	M30	75 (2.95)	15 (0.59)	45 (1.77)	15 (0.59)

Description



① Measuring head angled 90° for difficult measuring tasks



Short Description

Eaton's inductive proximity sensors of the Premium+ series feature an enhanced measuring performance, durability and selection. Unlike the standard sensors, the Premium+ models feature a rugged stainless steel enclosure, impact-resistant front caps and an impact-absorbing sealant. The sensors are available in versions for AC, AC/DC and DC-only operation, with enclosure diameters of 12, 18 and 30 mm. Their interference immunity is unsurpassed at more than 20 volts/meter. The Premium+ series includes sensors with a specially short, cylindrical enclosure. Despite their small size, they feature the same measuring range as the longer standard sizes. This allows the sensors to be used in applications where mounting space is limited. All sensors are equipped with a LED with 360° visibility.







Product Features

- New, wider product range – models with two-wire, three-wire, AC, DC and AC/DC connection.
- Resistant against mechanical and environmental strain.
- Designed with stainless steel barrel and new potting compound for robust, high temperature, high pressure washdown, as well as intense shock and vibration applications.
- Unmatched high noise immunity eliminates problems associated with electrical noise (all models > 20 Volt/Meter).
- Output status lamp is visible through 360° from any direction and at all light conditions.
- AC/DC and DC models have resettable short-circuit and polarity reversal protection.
- Models with 90° measuring head offer unique problem-solving capabilities.
- Large temperature range (-25 to 70 °C).
- Small sizes for space-saving installation available.
- Versions with cable for hard wiring or M12 plug connector for fast installation and simple replacement.

Approvals

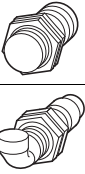
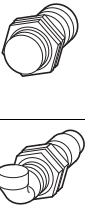



Ordering

	Rated switching distance S_n mm	Type of mounting	Switching type	For connection of:	Contact configuration N/O = normally open contact N/C = normally closed contact	Part no.	Article no.	Price see price list	Std. pack
E57 Premium Plus									
2-wire, Stainless steel Rated operational voltage U_e 20 - 250 V AC									
M12 x 1									
	2	Flush	-	2 m connection cable	1 N/O	E57LAL12A2¹⁾	135995		1 off  
			-	Plug-in connection M12 x 1	1 N/O	E57LAL12A2SA¹⁾	135998		
			-	2 m connection cable	1 NC	E57LBL12A2¹⁾	136030		
			-	Plug-in connection M12 x 1	1 NC	E57LBL12A2SA¹⁾	136033		
	4	Non-flush	-	2 m connection cable	1 N/O	E57LAL12A2E¹⁾	135996		
			-	Plug-in connection M12 x 1	1 N/O	E57LAL12A2EA¹⁾	135997		
			-	2 m connection cable	1 NC	E57LBL12A2E¹⁾	136031		
			-	Plug-in connection M12 x 1	1 NC	E57LBL12A2EA¹⁾	136032		
M18 x 1									
	5	Flush	-	2 m connection cable	1 N/O	E57LAL18A2¹⁾	136007		
			-	2 m connection cable	1 NC	E57LBL18A2¹⁾	136042		
			-	Plug-in connection M12 x 1	1 NC	E57LBL18A2SA¹⁾	136045		
			-	2 m connection cable	1 N/O	E57RAL18A2²⁾	136066		
		5	Non-flush	-	2 m connection cable	1 NC	E57RBL18A2²⁾	136078	
				-	Plug-in connection M12 x 1	1 N/O	E57RAL18A2SA²⁾	136069	
				-	Plug-in connection M12 x 1	1 NC	E57RBL18A2SA²⁾	136081	
				-	2 m connection cable	1 N/O	E57LAL18A2E¹⁾	136008	
	8	Non-flush	-	Plug-in connection M12 x 1	1 N/O	E57LAL18A2EA¹⁾	136009		
			-	2 m connection cable	1 NC	E57LBL18A2E¹⁾	136043		
			-	Plug-in connection M12 x 1	1 NC	E57LBL18A2EA¹⁾	136044		
			-	Plug-in connection M12 x 1	1 N/O	E57RAL18A2EA²⁾	136068		
		8	Non-flush	-	Plug-in connection M12 x 1	1 NC	E57RBL18A2EA²⁾	136080	
				-	2 m connection cable	1 N/O	E57RAL18A2E²⁾	136067	
				-	2 m connection cable	1 NC	E57RBL18A2E²⁾	136079	
				-	2 m connection cable	1 NC	E57LAL30A2¹⁾	136018	
M30 x 1.5									
	10	Flush	-	Plug-in connection M12 x 1	1 N/O	E57LAL30A2SA¹⁾	136021		
			-	2 m connection cable	1 NC	E57LBL30A2¹⁾	136054		
			-	Plug-in connection M12 x 1	1 NC	E57LBL30A2SA¹⁾	136057		
			-	2 m connection cable	1 N/O	E57LAL30A2E¹⁾	136019		
	15	Non-flush	-	Plug-in connection M12 x 1	1 N/O	E57LAL30A2EA¹⁾	136020		
			-	2 m connection cable	1 NC	E57LBL30A2E¹⁾	136055		
			-	Plug-in connection M12 x 1	1 NC	E57LBL30A2EA¹⁾	136056		

Information relevant for export to North America









- | | |
|----------------------|---|
| 1) Product Standards | UL 508; CSA-C22.2 No. 14; IEC60947-5-2; CE marking |
| UL File No. | E166051 |
| UL CCN | NRKH, NRKH7 |
| CSA File No. | 50513 |
| CSA Class No. | 3211-03 |
| NA Certification | UL listed, CSA certified |
| Max. Voltage Rating | 250 V AC |
| Degree of Protection | IEC: IP67, IP69K; UL/CSA Type: 4, 4x, 6, 6P, 12, 13 |
| 2) Product Standards | UL 508; IEC60947-5-2; CE marking |
| UL File No. | E166051 |
| UL CCN | NRKH, NRKH7 |
| NA Certification | UL listed |
| Max. Voltage Rating | 250 V AC |
| Degree of Protection | IEC: IP67, IP69K; UL/CSA Type: 4, 4x, 6, 6P, 12, 13 |

Rated switching distance S_n mm	Type of mounting	Switching type	For connection of:	Contact configuration N/O = normally open contact N/C = normally closed contact	Part no.	Article no.	Price see price list	Std. pack
E57 Premium Plus								
3-wire, Stainless steel Rated operational voltage U_o 6 - 48 V DC								
M12 x 1								
	2	Flush	NPN	2 m connection cable	1 N/O	E57LAL12T110 ²⁾	135999	1 off  
				Plug-in connection M12 x 1	1 N/O	E57LAL12T110SD ²⁾	136002	
				2 m connection cable	1 NC	E57LBL12T110 ²⁾	136034	
				Plug-in connection M12 x 1	1 NC	E57LBL12T110SD ²⁾	136037	
			PNP	2 m connection cable	1 N/O	E57LAL12T111 ²⁾	136003	
				Plug-in connection M12 x 1	1 N/O	E57LAL12T111SD ²⁾	136006	
				2 m connection cable	1 NC	E57LBL12T111 ²⁾	136038	
				Plug-in connection M12 x 1	1 NC	E57LBL12T111SD ²⁾	136041	
	4	Non-flush	NPN	2 m connection cable	1 N/O	E57LAL12T110E ²⁾	136000	
				Plug-in connection M12 x 1	1 N/O	E57LAL12T110ED ²⁾	136001	
				2 m connection cable	1 NC	E57LBL12T110E ²⁾	136035	
				Plug-in connection M12 x 1	1 NC	E57LBL12T110ED ²⁾	136036	
			PNP	2 m connection cable	1 N/O	E57LAL12T111E ²⁾	136004	
				Plug-in connection M12 x 1	1 N/O	E57LAL12T111ED ²⁾	136005	
				2 m connection cable	1 NC	E57LBL12T111E ²⁾	136039	
				Plug-in connection M12 x 1	1 NC	E57LBL12T111ED ²⁾	136040	
6	Semi-flush	PNP	2 m connection cable	1 N/O	E57-12LE06-B	135896	1 off	
			2 m connection cable	1 NC	E57-12LE06-B1	135897		
			Plug-in connection M12 x 1	1 NC	E57-12LE06-B1D	135898		
			Plug-in connection M12 x 1	1 N/O	E57-12LE06-BD	135899		
		NPN	2 m connection cable	1 N/O	E57-12LE06-C	135900		
			2 m connection cable	1 NC	E57-12LE06-C1	135901		
			Plug-in connection M12 x 1	1 NC	E57-12LE06-C1D	135902		
			Plug-in connection M12 x 1	1 N/O	E57-12LE06-CD	135903		
10	Semi-flush	PNP	2 m connection cable	1 N/O	E57-12LE10-B	135904		
			2 m connection cable	1 NC	E57-12LE10-B1	135905		
			Plug-in connection M12 x 1	1 NC	E57-12LE10-B1D	135906		
			Plug-in connection M12 x 1	1 N/O	E57-12LE10-BD	135907		
		NPN	2 m connection cable	1 N/O	E57-12LE10-C	135908		
			2 m connection cable	1 NC	E57-12LE10-C1	135909		
			Plug-in connection M12 x 1	1 NC	E57-12LE10-C1D	135910		
			Plug-in connection M12 x 1	1 N/O	E57-12LE10-CD	135911		

Information relevant for export to North America





²⁾ Product Standards	UL 508; CSA-C22.2 No. 14; IEC60947-5-2; CE marking
UL File No.	E166051
UL CCN	NRKH, NRKH7
CSA File No.	50513
CSA Class No.	3211-03
NA Certification	UL listed, CSA certified
Max. Voltage Rating	48 V DC
Degree of Protection	IEC: IP67, IP69K; UL/CSA Type: 4, 4x, 6, 6P, 12, 13

Rated switching distance S_n mm	Type of mounting	Switching type	For connection of:	Contact configuration N/O = normally open contact N/C = normally closed contact	Part no.	Article no.	Price see price list	Std. pack
E57 Premium Plus								
3-wire, Stainless steel Rated operational voltage U_o 6 - 48 V DC								
M18 x 1								
	5	Flush	NPN	2 m connection cable	1 N/O	E57LAL18T110 ²⁾	136010	1 off  
				Plug-in connection M12 x 1	1 N/O	E57LAL18T110SD ²⁾	136013	
				2 m connection cable	1 NC	E57LBL18T110 ²⁾	136046	
				Plug-in connection M12 x 1	1 NC	E57LBL18T110SD ²⁾	136049	
			PNP	2 m connection cable	1 N/O	E57LAL18T111 ²⁾	136014	
				Plug-in connection M12 x 1	1 N/O	E57LAL18T111SD ²⁾	136017	
				2 m connection cable	1 NC	E57LBL18T111 ²⁾	136050	
				Plug-in connection M12 x 1	1 NC	E57LBL18T111SD ²⁾	136053	
	5	Flush	NPN	2 m connection cable	1 N/O	E57RAL18T110 ¹⁾	136070	
				Plug-in connection M12 x 1	1 N/O	E57RAL18T110SD ¹⁾	136073	
				2 m connection cable	1 NC	E57RBL18T110 ¹⁾	136082	
				Plug-in connection M12 x 1	1 NC	E57RBL18T110SD ¹⁾	136085	
			PNP	2 m connection cable	1 N/O	E57RAL18T111 ¹⁾	136074	
				Plug-in connection M12 x 1	1 N/O	E57RAL18T111SD ¹⁾	136077	
				2 m connection cable	1 NC	E57RBL18T111 ¹⁾	136086	
				Plug-in connection M12 x 1	1 NC	E57RBL18T111SD ¹⁾	136089	
	8	Non-flush	NPN	2 m connection cable	1 N/O	E57LAL18T110E ²⁾	136011	
				Plug-in connection M12 x 1	1 N/O	E57LAL18T110ED ²⁾	136012	
				2 m connection cable	1 NC	E57LBL18T110E ²⁾	136047	
				Plug-in connection M12 x 1	1 NC	E57LBL18T110ED ²⁾	136048	
			PNP	2 m connection cable	1 N/O	E57LAL18T111E ²⁾	136015	
				Plug-in connection M12 x 1	1 N/O	E57LAL18T111ED ²⁾	136016	
				2 m connection cable	1 NC	E57LBL18T111E ²⁾	136051	
				Plug-in connection M12 x 1	1 NC	E57LBL18T111ED ²⁾	136052	
	8	Non-flush	NPN	2 m connection cable	1 N/O	E57RAL18T110E ¹⁾	136071	
				Plug-in connection M12 x 1	1 N/O	E57RAL18T110ED ¹⁾	136072	
				2 m connection cable	1 NC	E57RBL18T110E ¹⁾	136083	
				Plug-in connection M12 x 1	1 NC	E57RBL18T110ED ¹⁾	136084	
			PNP	2 m connection cable	1 N/O	E57RAL18T111E ¹⁾	136075	
				Plug-in connection M12 x 1	1 N/O	E57RAL18T111ED ¹⁾	136076	
				2 m connection cable	1 NC	E57RBL18T111E ¹⁾	136087	
				Plug-in connection M12 x 1	1 NC	E57RBL18T111ED ¹⁾	136088	

Information relevant for export to North America



- | | |
|----------------------|---|
| 1) Product Standards | UL 508; IEC60947-5-2; CE marking |
| UL File No. | E166051 |
| UL CCN | NRKH, NRKH7 |
| NA Certification | UL listed |
| Max. Voltage Rating | 48 V DC |
| Degree of Protection | IEC: IP67, IP69K; UL/CSA Type: 4, 4x, 6, 6P, 12, 13 |
| 2) Product Standards | UL 508; CSA-C22.2 No. 14; IEC60947-5-2; CE marking |
| UL File No. | E166051 |
| UL CCN | NRKH, NRKH7 |
| CSA File No. | 50513 |
| CSA Class No. | 3211-03 |
| NA Certification | UL listed, CSA certified |
| Max. Voltage Rating | 48 V DC |
| Degree of Protection | IEC: IP67, IP69K; UL/CSA Type: 4, 4x, 6, 6P, 12, 13 |









Rated switching distance S_n mm	Type of mounting	Switching type	For connection of:	Contact configuration N/O = normally open contact N/C = normally closed contact	Part no.	Article no.	Price see price list	Std. pack
E57 Premium Plus								
3-wire, Stainless steel Rated operational voltage U_o 6 - 48 V DC								
M18 x 1								
	12	Semi-flush	PNP	2 m connection cable	1 N/O	E57-18LE12-B	135941	1 off
				2 m connection cable	1 NC	E57-18LE12-B1	135942	
				Plug-in connection M12 x 1	1 NC	E57-18LE12-B1D	135943	
				Plug-in connection M12 x 1	1 N/O	E57-18LE12-BD	135944	
			NPN	2 m connection cable	1 N/O	E57-18LE12-C	135945	
				2 m connection cable	1 NC	E57-18LE12-C1	135946	
				Plug-in connection M12 x 1	1 NC	E57-18LE12-C1D	135947	
				Plug-in connection M12 x 1	1 N/O	E57-18LE12-CD	135948	
	20	Semi-flush	PNP	2 m connection cable	1 N/O	E57-18LE20-B	135949	
				2 m connection cable	1 NC	E57-18LE20-B1	135950	
				Plug-in connection M12 x 1	1 NC	E57-18LE20-B1D	135951	
				Plug-in connection M12 x 1	1 N/O	E57-18LE20-BD	135952	
			NPN	2 m connection cable	1 N/O	E57-18LE20-C	135953	
				2 m connection cable	1 NC	E57-18LE20-C1	135954	
				Plug-in connection M12 x 1	1 NC	E57-18LE20-C1D	135955	
				Plug-in connection M12 x 1	1 N/O	E57-18LE20-CD	135956	
M30 x 1.5								
	15	Flush	NPN	2 m connection cable	1 N/O	E57LAL30T110 ²⁾	136022	1 off 
				Plug-in connection M12 x 1	1 N/O	E57LAL30T110SD ²⁾	136025	
				2 m connection cable	1 NC	E57LBL30T110 ²⁾	136058	
			Plug-in connection M12 x 1	1 NC	E57LBL30T110SD ²⁾	136061		
			PNP	2 m connection cable	1 N/O	E57LAL30T111 ²⁾	136026	
				Plug-in connection M12 x 1	1 N/O	E57LAL30T111SD ²⁾	136029	
		2 m connection cable		1 NC	E57LBL30T111 ²⁾	136062		
		Plug-in connection M12 x 1	1 NC	E57LBL30T111SD ²⁾	136065			
		Non-flush	NPN	2 m connection cable	1 N/O	E57LAL30T110E ²⁾	136023	
				Plug-in connection M12 x 1	1 N/O	E57LAL30T110ED ²⁾	136024	
				2 m connection cable	1 NC	E57LBL30T110E ²⁾	136059	
			Plug-in connection M12 x 1	1 NC	E57LBL30T110ED ²⁾	136060		
	PNP		2 m connection cable	1 N/O	E57LAL30T111E ²⁾	136027		
			Plug-in connection M12 x 1	1 N/O	E57LAL30T111ED ²⁾	136028		
		2 m connection cable	1 NC	E57LBL30T111E ²⁾	136063			
	Plug-in connection M12 x 1	1 NC	E57LBL30T111ED ²⁾	136064				
	22	Semi-flush	PNP	2 m connection cable	1 N/O	E57-30LE22-B	135987	
				2 m connection cable	1 NC	E57-30LE22-B1	135988	
				Plug-in connection M12 x 1	1 NC	E57-30LE22-B1D	135989	
				Plug-in connection M12 x 1	1 N/O	E57-30LE22-BD	135990	
			NPN	2 m connection cable	1 N/O	E57-30LE22-C	135991	
				2 m connection cable	1 NC	E57-30LE22-C1	135992	
				Plug-in connection M12 x 1	1 NC	E57-30LE22-C1D	135993	
				Plug-in connection M12 x 1	1 N/O	E57-30LE22-CD	135994	





Information relevant for export to North America



²⁾ Product Standards
UL File No.
UL CCN
CSA File No.
CSA Class No.
NA Certification
Max. Voltage Rating
Degree of Protection

UL 508; CSA-C22.2 No. 14; IEC60947-5-2; CE marking
E166051
NRKH, NRKH7
50513
3211-03
UL listed, CSA certified
48 V DC
IEC: IP67, IP69K; UL/CSA Type: 4, 4x, 6, 6P, 12, 13

	Rated switching distance S_n mm	Type of mounting	Switching type	For connection of:	Contact configuration N/O = normally open contact N/C = normally closed contact	Part no.	Article no.	Price see price list	Std. pack
E57-Premium-Plus-Short									
2-wire, Stainless steel									
Rated operational voltage U_e 40 - 250 V AC, 20 - 250 V DC									
M12 x 1									
	2	Flush	-	2 m connection cable	1 N/O	E57SAL12A2	136090		1 off  
			-	Plug-in connection M12 x 1	1 N/O	E57SAL12A2SA	136093		
			-	2 m connection cable	1 NC	E57SBL12A2	136138		
			-	Plug-in connection M12 x 1	1 NC	E57SBL12A2SA	136141		
	4	Non-flush	-	2 m connection cable	1 N/O	E57SAL12A2E	136091		
			-	Plug-in connection M12 x 1	1 N/O	E57SAL12A2EA	136092		
			-	2 m connection cable	1 NC	E57SBL12A2E	136139		
			-	Plug-in connection M12 x 1	1 NC	E57SBL12A2EA	136140		
M18 x 1									
	5	Flush	-	2 m connection cable	1 N/O	E57SAL18A2	136106		
			-	Plug-in connection M12 x 1	1 N/O	E57SAL18A2SA	136109		
			-	2 m connection cable	1 NC	E57SBL18A2	136152		
			-	Plug-in connection M12 x 1	1 NC	E57SBL18A2SA	136155		
	8	Non-flush	-	2 m connection cable	1 N/O	E57SAL18A2E	136107		
			-	Plug-in connection M12 x 1	1 N/O	E57SAL18A2EA	136108		
			-	2 m connection cable	1 NC	E57SBL18A2E	136153		
			-	Plug-in connection M12 x 1	1 NC	E57SBL18A2EA	136154		
M30 x 1.5									
	10	Flush	-	2 m connection cable	1 N/O	E57SAL30A2	136122		
			-	Plug-in connection M12 x 1	1 N/O	E57SAL30A2SA	136125		
			-	2 m connection cable	1 NC	E57SBL30A2	136168		
			-	Plug-in connection M12 x 1	1 NC	E57SBL30A2SA	136171		
	15	Non-flush	-	2 m connection cable	1 N/O	E57SAL30A2E	136123		
			-	Plug-in connection M12 x 1	1 N/O	E57SAL30A2EA	136124		
			-	2 m connection cable	1 NC	E57SBL30A2E	136169		
			-	Plug-in connection M12 x 1	1 NC	E57SBL30A2EA	136170		
Rated operational voltage U_e 40 - 250 V AC									
M12 x 1									
	2	Flush	-	2 m connection cable	1 N/O	E57SAL12A4	136094		
			-	Plug-in connection M12 x 1	1 N/O	E57SAL12A4SA	136097		
			-	2 m connection cable	1 NC	E57SBL12A4	136142		
			-	Plug-in connection M12 x 1	1 NC	E57SBL12A4SA	136145		
	4	Non-flush	-	2 m connection cable	1 N/O	E57SAL12A4E	136095		
			-	Plug-in connection M12 x 1	1 N/O	E57SAL12A4EA	136096		
			-	2 m connection cable	1 NC	E57SBL12A4E	136143		
			-	Plug-in connection M12 x 1	1 NC	E57SBL12A4EA	136144		
M18 x 1									
	5	Flush	-	2 m connection cable	1 N/O	E57SAL18A4	136110		
			-	Plug-in connection M12 x 1	1 N/O	E57SAL18A4SA	136113		
			-	2 m connection cable	1 NC	E57SBL18A4	136156		
			-	Plug-in connection M12 x 1	1 NC	E57SBL18A4SA	136159		
	8	Non-flush	-	2 m connection cable	1 N/O	E57SAL18A4E	136111		
			-	Plug-in connection M12 x 1	1 N/O	E57SAL18A4EA	136112		
			-	2 m connection cable	1 NC	E57SBL18A4E	136157		
			-	Plug-in connection M12 x 1	1 NC	E57SBL18A4EA	136158		
M30 x 1.5									
	10	Flush	-	2 m connection cable	1 N/O	E57SAL30A4	136126		
			-	Plug-in connection M12 x 1	1 N/O	E57SAL30A4SA	136129		
			-	2 m connection cable	1 NC	E57SBL30A4	136172		
			-	Plug-in connection M12 x 1	1 NC	E57SBL30A4SA	136175		
	15	Non-flush	-	2 m connection cable	1 N/O	E57SAL30A4E	136127		
			-	Plug-in connection M12 x 1	1 N/O	E57SAL30A4EA	136128		
			-	2 m connection cable	1 NC	E57SBL30A4E	136173		
			-	Plug-in connection M12 x 1	1 NC	E57SBL30A4EA	136174		

Rated switching distance S_n mm	Type of mounting	Switching type	For connection of:	Contact configuration N/O = normally open contact N/C = normally closed contact	Part no.	Article no.	Price see price list	Std. pack		
E57-Premium-Plus-Short										
3-wire, Stainless steel										
Rated operational voltage U_e 6 - 48 V DC										
M12 x 1										
	2	Flush	NPN	2 m connection cable	1 N/O	E57SAL12T110	136098	1 off  		
			NPN	Plug-in connection M12 x 1	1 N/O	E57SAL12T110SD	136101			
			PNP	2 m connection cable	1 N/O	E57SAL12T111	136102			
			PNP	Plug-in connection M12 x 1	1 N/O	E57SAL12T111SD	136105			
			PNP	2 m connection cable	1 NC	E57SBL12T111	136148			
			PNP	Plug-in connection M12 x 1	1 NC	E57SBL12T111SD	136151			
	4	Non-flush	NPN	2 m connection cable	1 N/O	E57SAL12T110E	136099			
			NPN	Plug-in connection M12 x 1	1 N/O	E57SAL12T110ED	136100			
			PNP	2 m connection cable	1 N/O	E57SAL12T111E	136103			
			PNP	Plug-in connection M12 x 1	1 N/O	E57SAL12T111ED	136104			
			NPN	2 m connection cable	1 NC	E57SBL12T110E	136146			
			NPN	Plug-in connection M12 x 1	1 NC	E57SBL12T110ED	136147			
			PNP	2 m connection cable	1 NC	E57SBL12T111E	136149			
			PNP	Plug-in connection M12 x 1	1 NC	E57SBL12T111ED	136150			
M18 x 1										
	5	Flush	NPN	2 m connection cable	1 N/O	E57SAL18T110	136114			
			NPN	Plug-in connection M12 x 1	1 N/O	E57SAL18T110SD	136117			
			PNP	2 m connection cable	1 N/O	E57SAL18T111	136118			
			PNP	Plug-in connection M12 x 1	1 N/O	E57SAL18T111SD	136121			
			NPN	2 m connection cable	1 NC	E57SBL18T110	136160			
			NPN	Plug-in connection M12 x 1	1 NC	E57SBL18T110SD	136163			
			PNP	2 m connection cable	1 NC	E57SBL18T111	136164			
			PNP	Plug-in connection M12 x 1	1 NC	E57SBL18T111SD	136167			
	5	Non-flush	NPN	2 m connection cable	1 N/O	E57SAL18T110E	136115			
			NPN	2 m connection cable	1 NC	E57SBL18T110E	136161			
			NPN	Plug-in connection M12 x 1	1 N/O	E57SAL18T110ED	136116			
			PNP	2 m connection cable	1 N/O	E57SAL18T111E	136119			
			PNP	Plug-in connection M12 x 1	1 N/O	E57SAL18T111ED	136120			
			NPN	Plug-in connection M12 x 1	1 NC	E57SBL18T110ED	136162			
5	Non-flush	PNP	2 m connection cable	1 NC	E57SBL18T111E	136165				
		PNP	Plug-in connection M12 x 1	1 NC	E57SBL18T111ED	136166				
		M30 x 1.5								
			15	Flush	NPN	2 m connection cable	1 N/O	E57SAL30T110	136130	
					NPN	Plug-in connection M12 x 1	1 N/O	E57SAL30T110SD	136133	
					PNP	2 m connection cable	1 N/O	E57SAL30T111	136134	
					PNP	Plug-in connection M12 x 1	1 N/O	E57SAL30T111SD	136137	
					NPN	2 m connection cable	1 NC	E57SBL30T110	136176	
NPN	Plug-in connection M12 x 1				1 NC	E57SBL30T110SD	136179			
PNP	2 m connection cable				1 NC	E57SBL30T111	136180			
PNP	Plug-in connection M12 x 1				1 NC	E57SBL30T111SD	136183			
15	Non-flush		NPN	2 m connection cable	1 N/O	E57SAL30T110E	136131			
			NPN	2 m connection cable	1 NC	E57SBL30T110E	136177			
			NPN	Plug-in connection M12 x 1	1 N/O	E57SAL30T110ED	136132			
			PNP	2 m connection cable	1 N/O	E57SAL30T111E	136135			
			PNP	Plug-in connection M12 x 1	1 N/O	E57SAL30T111ED	136136			
			NPN	Plug-in connection M12 x 1	1 NC	E57SBL30T110ED	136178			
15	Non-flush	PNP	2 m connection cable	1 NC	E57SBL30T111E	136181				
		PNP	Plug-in connection M12 x 1	1 NC	E57SBL30T111ED	136182				

Information relevant for export to North America



Product Standards	UL 508; CSA-C22.2 No. 14; IEC60947-5-2; CE marking
UL File No.	E166051
UL CCN	NRKH, NRKH7
CSA File No.	50513
CSA Class No.	3211-03
NA Certification	UL listed, CSA certified
Max. Voltage Rating	250 V AC, 250 V DC
Degree of Protection	IEC: IP67; UL/CSA Type: 4, 4x, 6, 6P, 12, 13

Engineering

Circuit diagram

Rated operational voltage 2-Wire Sensors	Contact	2 m connection cable	Plug-in connection M12 (front view plug)
AC/DC and AC sensors Example AC connection	N/O and NC		
AC/DC sensor Example DC current connection	N/O and NC (NPN)		
	N/O and NC (PNP)		
3-Wire Sensors 6-48 V DC_x	N/O (NPN)		
	N/O (PNP)		
	NC (NPN)		
	NC (PNP)		

Technical data

				E57L...L12A... E57L...L18A... E57R...L18A... E57L...L30A...	E57L...L12T... E57L...L18T... E57R...L18T... E57L...L30T...	E57-12LE... E57-18LE... E57-30LE...
General						
Standards				IEC/EN 60947-5-2	IEC/EN 60947-5-2	IEC/EN 60947-5-2
Ambient temperature			°C	- 25 - + 70	- 25 - + 70	- 25 - + 70
Protection type				IP67	IP67	IP67
Mechanical shock resistance			g	30 Shock duration 11 ms	30 Shock duration 11 ms	30 Shock duration 11 ms
Characteristics						
Temperature drift of S _n			%	10	10	10
Switching hysteresis of S _n			%	20	15	15
Rated operational voltage			U _e	20 - 250 V AC	6 - 48 V DC	6 - 48 V DC
Maximum load current			I _e	mA < 500 (25 °C) / 250 (70 °C)	< 500 (6 - 30 V DC)	< 500 (6 - 30 V DC)
Switching Frequency						
	... L12A...		Hz	20	800	800
	... L18A...		Hz	20	500	500
	... L30A...		Hz	20	300	300
Switching state display			LED	Red	Red	Red
Connection				2-wire	3-wire	3-wire
Design (outer dimensions)						
	... L12A...		mm	M12 x 1	M12 x 1	M12 x 1
	... L18A...		mm	M18 x 1	M18 x 1	M18 x 1
	... L30A...		mm	M30 x 1.5	M30 x 1.5	M30 x 1
Material				Stainless steel	Stainless steel	Stainless steel

				E57S...L12A2 E57S...L18A2 E57S...L30A2	E57S...L12A4 E57S...L18A4 E57S...L30A4	E57S...L12T... E57S...L18T... E57S...L30T...
General						
Standards				IEC/EN 60947-5-2	IEC/EN 60947-5-2	IEC/EN 60947-5-2
Ambient temperature			°C	- 25 - + 70	- 25 - + 70	- 25 - + 70
Protection type				IP67	IP67	IP67
Mechanical shock resistance			g	30 Shock duration 11 ms	30 Shock duration 11 ms	30 Shock duration 11 ms
Characteristics						
Temperature drift of S _n			%	10	10	10
Switching hysteresis of S _n			%	20	20	15
Rated operational voltage			U _e	40 - 250 V AC 20 - 250 V DC	40 - 250 V AC	6 - 48 V DC
Maximum load current			I _e	mA < 250 (25 °C) / 200 (70 °C)	< 500 (25 °C) / 250 (70 °C)	< 500 (6 - 32 V DC) / 250 (32 - 48 V DC)
Switching Frequency						
	... L12A...		Hz	60	20	800
	... L18A...		Hz	60	20	500
	... L30A...		Hz	60	20	300
Switching state display			LED	Red	Red	Red
Connection				2-wire	2-wire	3-wire
Design (outer dimensions)						
	... L12A...		mm	M12 x 1	M12 x 1	M12 x 1
	... L18A...		mm	M18 x 1	M18 x 1	M18 x 1
	... L30A...		mm	M30 x 1.5	M30 x 1.5	M30 x 1.5
Material				Stainless steel	Stainless steel	Stainless steel

Notes

Further technical data can be found in the Online Catalog at <http://de.ecat.moeller.net>

Dimensions

2 m connection cable

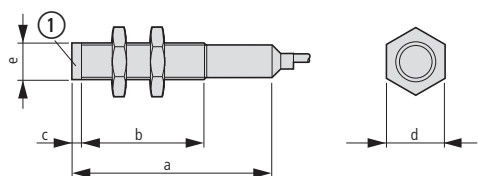

① Sensor surface

Plug-in connection M12 x 1

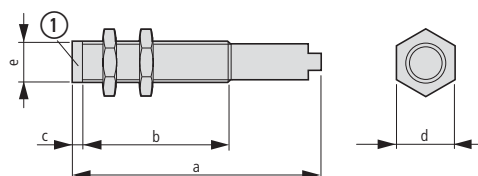

2	a	b	c	d	e
mm (inch)	mm (inch)	mm (inch)	mm (inch)	mm (inch)	mm

AC, 2 m connection cable						
∅ 12	①	62.4 (2.46)	50.3 (1.98)	-	16.8 (0.67)	M12 x 1
	③	72.7 (2.87)	50.3 (1.98)	9.14 (0.36)	16.8 (0.67)	M12 x 1
∅ 18	①	64.5 (2.54)	50.9 (2.00)	-	23.8 (0.94)	M18 x 1
	③	66.0 (2.60)	37.2 (1.47)	14.1 (0.56)	23.8 (0.94)	M18 x 1
∅ 30	①	69.3 (2.73)	50.3 (1.98)	-	35.9 (1.41)	M30 x 1.5
	③	69.3 (2.73)	37.8 (1.49)	13.26 (0.52)	35.9 (1.41)	M30 x 1.5

AC, plug-in connection M12						
∅ 12	①	68.4 (2.69)	50.3 (1.98)	-	16.8 (0.67)	M12 x 1
	③	77.7 (3.06)	50.3 (1.98)	9.14 (0.36)	9.14 (0.36)	M12 x 1
∅ 18	①	69.06 (2.72)	50.9 (2.00)	-	23.8 (0.94)	M18 x 1
	③	69.4 (2.74)	37.2 (1.47)	14.1 (0.56)	23.8 (0.94)	M18 x 1
∅ 30	①	73.8 (2.91)	50.3 (1.98)	-	35.9 (1.41)	M30 x 1.5
	③	73.8 (2.91)	37.8 (1.49)	13.26 (0.52)	35.9 (1.41)	M30 x 1.5

3	a_x	b_x	c_x	d_x	e_x
mm (inch)_x	mm (inch)_x	mm (inch)_x	mm (inch)_x	mm (inch)_x	MM_x

DC, 2 m connection cable						
∅ 12	①	62.4 (2.46)	50.3 (1.98)	-	16.8 (0.67)	_xM12 x 1
	②	72.8 (2.87)	57.9 (2.28)	1.62 (0.06)	16.8 (0.67)	_xM12 x 1
	③	72.7 (2.87)	50.3 (1.98)	9.14 (0.36)	16.8 (0.67)	_xM12 x 1
∅ 18	①	64.5 (2.54)	50.9 (2.00)	-	23.8 (0.94)	_xM18 x 1
	②	66.1 (2.60)	48.2 (1.90)	2.54 (0.10)	23.8 (0.94)	_xM18 x 1
	③	66.0 (2.60)	37.2 (1.47)	14.1 (0.56)	23.8 (0.94)	_xM18 x 1
∅ 30	①	69.3 (2.73)	50.3 (1.98)	-	35.9 (1.41)	M30 x 1.5
	②	67.8 (2.67)	48.2 (1.90)	3.30 (0.13)	35.9 (1.41)	M30 x 1.5
	③	69.3 (2.73)	37.8 (1.49)	13.26 (0.52)	35.9 (1.41)	M30 x 1.5

DC, plug-in connection M12						
∅ 12	①	68.7 (2.71)	50.3 (1.98)	-	16.8 (0.67)	_xM12 x 1
	②	77.2 (3.04)	57.9 (2.28)	1.62 (0.06)	16.8 (0.67)	_xM12 x 1
	③	77.7 (3.06)	50.9 (1.98)	9.14 (0.36)	16.8 (0.67)	_xM12 x 1
∅ 18	①	69.3 (2.73)	50.9 (2.00)	-	23.8 (0.94)	_xM18 x 1
	②	69.1 (2.72)	48.2 (1.90)	2.54 (0.10)	23.8 (0.94)	_xM18 x 1
	③	69.4 (2.74)	37.2 (1.47)	14.1 (0.56)	23.8 (0.94)	_xM18 x 1
∅ 30	①	74.1 (2.92)	50.3 (1.98)	-	35.9 (1.41)	M30 x 1.5
	②	70.6 (2.78)	48.2 (1.90)	3.30 (0.13)	35.9 (1.41)	M30 x 1.5
	③	74.1 (2.92)	37.8 (1.49)	13.26 (0.52)	35.9 (1.41)	M30 x 1.5

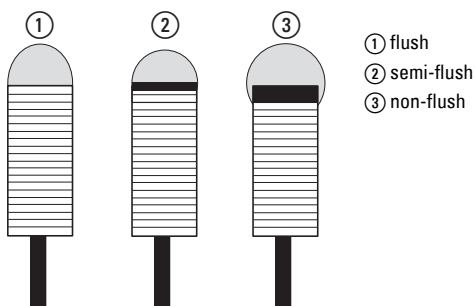

E57R...A2...
E57R...110...
E57R...111...

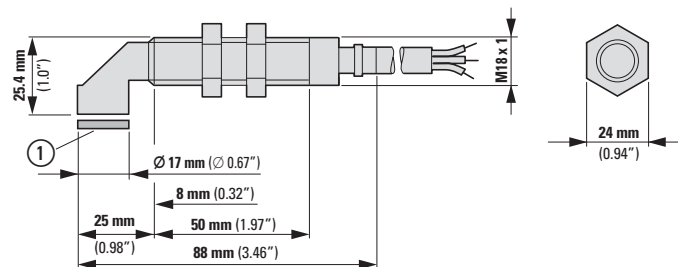

① Sensor surface

E57R...SA
E57R...EA
E57R...SD
E57R...ED

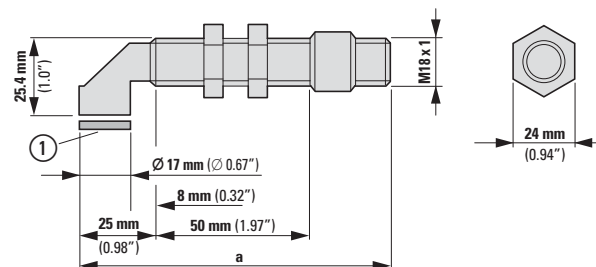

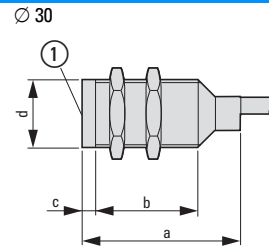
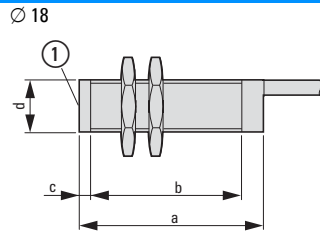
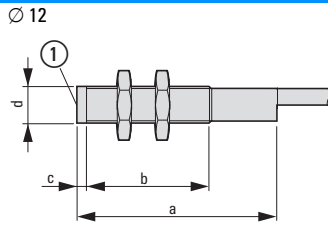

① Sensor surface

	a_x mm (inch)_x	b_x mm (inch)_x	c_x mm (inch)_x	d_x MM_x
---	--------------------	--------------------	--------------------	-------------

AC, 2 m connection cable					
Ø 12	①	51.7 (2.04)	39.6 (1.56)	0.5 (0.02)	_xM12 x 1
	③	51.7 (2.04)	35.1 (1.38)	5 (0.20)	_xM12 x 1
Ø 18	①	35.3 (1.39)	0.86 (21.82)	0.5 (0.02)	_xM18 x 1
	③	35.3 (1.39)	15.32 (0.60)	7 (0.28)	_xM18 x 1
Ø 30	①	40.2 (1.58)	25.15 (0.99)	0.8 (0.03)	M30 x 1.5
	③	44.9 (1.77)	17.27 (0.68)	13.26 (0.52)	M30 x 1.5

AC/DC, 2 m connection cable					
Ø 12	①	62.4 (2.46)	50.27 (1.98)	-	_xM12 x 1
	③	62.4 (2.46)	45.77 (1.80)	5 (0.20)	_xM12 x 1
Ø 18	①	64.5 (2.54)	50.9 (2.00)	-	_xM18 x 1
	③	64.5 (2.54)	44.4 (1.75)	7 (0.28)	_xM18 x 1
Ø 30	①	69.3 (2.72)	53.8 (2.12)	-	M30 x 1.5
	③	69.3 (2.72)	41.4 (1.63)	13.26 (0.52)	M30 x 1.5

	a_x mm (inch)_x	b_x mm (inch)_x	c_x mm (inch)_x	d_x MM_x
---	--------------------	--------------------	--------------------	-------------

DC, 2 m connection cable					
Ø 12	①	35.3 (1.39)	23.09 (0.91)	0.5 (0.02)	_xM12 x 1
	③	35.3 (1.39)	18.59 (0.73)	5 (0.20)	_xM12 x 1
Ø 18	①	35.3 (1.39)	21.82 (0.86)	0.5 (0.02)	_xM18 x 1
	③	35.3 (1.39)	15.32 (0.60)	7 (0.28)	_xM18 x 1
Ø 30	①	40.2 (1.58)	21.26 (0.84)	0.8 (0.03)	M30 x 1.5
	③	44.9 (1.77)	13.46 (0.53)	13.26 (0.52)	M30 x 1.5

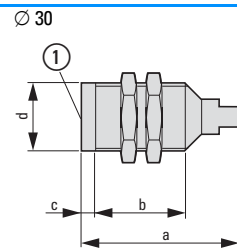
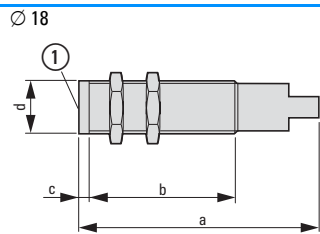
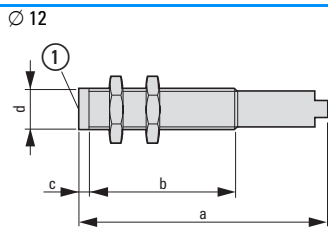
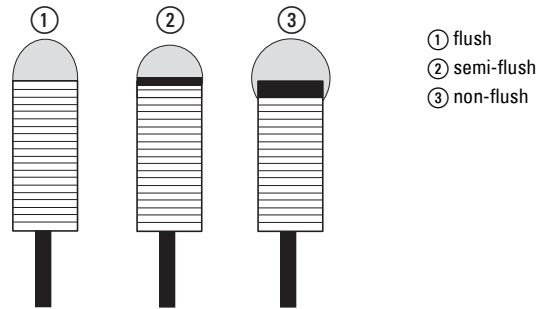

① Sensor surface

	a_x mm (inch)_x	b_x mm (inch)_x	c_x mm (inch)_x	d_x MM_x
---	--------------------	--------------------	--------------------	-------------

AC, plug-in connection M12					
Ø 12	①	57.8 (2.27)	39.6 (1.56)	0.5 (0.02)	_xM12 x 1
	③	57.8 (2.27)	35.1 (1.38)	5 (0.20)	_xM12 x 1
Ø 18	①	40.0 (1.57)	21.82 (0.86)	0.5 (0.02)	_xM18 x 1
	③	40.0 (1.57)	15.32 (0.60)	7 (0.28)	_xM18 x 1
Ø 30	①	44.8 (1.76)	25.15 (0.99)	0.8 (0.03)	M30 x 1.5
	③	49.5 (1.95)	17.27 (0.68)	13.26 (0.52)	M30 x 1.5

AC/DC, plug-in connection M12					
Ø 12	①	68.4 (2.69)	50.27 (1.98)	-	_xM12 x 1
	③	68.4 (2.69)	45.77 (1.80)	5 (0.20)	_xM12 x 1
Ø 18	①	69.06 (2.72)	50.9 (2.00)	-	_xM18 x 1
	③	69.06 (2.72)	44.4 (1.75)	7 (0.28)	_xM18 x 1
Ø 30	①	73.8 (2.91)	53.8 (2.12)	-	M30 x 1.5
	③	73.8 (2.91)	41.4 (1.63)	13.26 (0.52)	M30 x 1.5

	a_x mm (inch)_x	b_x mm (inch)_x	c_x mm (inch)_x	d_x MM_x
---	--------------------	--------------------	--------------------	-------------

DC, plug-in connection M12					
Ø 12	①	41.5 (1.64)	23.09 (0.91)	0.5 (0.02)	_xM12 x 1
	③	41.5 (1.64)	18.59 (0.73)	5 (0.20)	_xM12 x 1
Ø 18	①	40.3 (1.59)	21.82 (0.86)	0.5 (0.02)	_xM18 x 1
	③	40.3 (1.59)	15.32 (0.60)	7 (0.28)	_xM18 x 1
Ø 30	①	45.0 (1.77)	21.26 (0.84)	0.8 (0.03)	M30 x 1.5
	③	49.7 (1.96)	13.46 (0.53)	13.26 (0.52)	M30 x 1.5

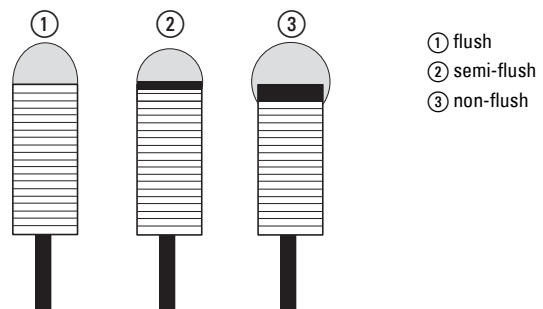

Description



- ① High Quality Stainless Steel Housings.
- ② M12 plug connector available for sizes 6.5 and 8 mm.
- ③ Sizes 5 mm and 8 mm with thread; 4 mm and 6.5 mm without thread.
- ④ Size 6.5 mm supplied complete with mounting bracket.

Short description

Eaton's unique inductive proximity have been developed specially for use in extremely small spaces. The wide range of available models with housing diameters from 8 mm down to 4 mm covers a multitude of application scenarios. The sensors feature three-wire connections with an input voltage of 10 to 30 V DC. Both shielded and unshielded versions are available.





Product features

- Small 4, 5, 6.5 and 8 mm diameters for use in applications with limited space for mounting sensors.
- Stainless steel enclosure.
- All models have an output status display.
- Short-circuit and reverse polarity protection.
- High degree of protection IP67.

Approvals



Ordering

mm	Rated switching distance S_n mm	Type of mounting	Switching type	For connection of:	Contact configuration N/O = normally open contact N/C = normally closed contact	Part no.	Article no.	Price see price list	Std. pack
E57-Miniatur									
Stainless steel, 3-wire, Rated operational voltage U_e 10 - 30 V DC									
$\varnothing 4$									
	0.8	Flush	NPN PNP	2 m connection cable	1 N/O	E57EAL4T110SP E57EAL4T111SP	136238 136239		1 off
M5 x 1									
	0.8	Flush	NPN PNP	2 m connection cable	1 N/O	E57EAL5T110SP E57EAL5T111SP	136240 136241		1 off
$\varnothing 6,5$									
	1	Flush	NPN PNP	2 m connection cable	1 N/O	E57EAL6T110SP E57EAL6T111SP	136243 136245		1 off
	2	Non-flush	NPN PNP	2 m connection cable	1 N/O	E57EAL6T110EP E57EAL6T111EP	136242 136244		
M8 x 1									
	1	Flush	NPN	2 m connection cable	1 N/O	E57EAL8T110SP	136249		1 off
				1 NC	E57EBL8T110SP	136257			
			Plug-in connection M12 x 1	1 N/O	E57EAL8T110SD	136248			
			1 NC	E57EBL8T110SD	136256				
	PNP	2 m connection cable	1 N/O	E57EAL8T111SP	136253				
		1 NC	E57EBL8T111SP	136261					
	Plug-in connection M12 x 1	1 N/O	E57EAL8T111SD	136252					
	1 NC	E57EBL8T111SD	136260						
	2	Non-flush	NPN	2 m connection cable	1 N/O	E57EAL8T110EP	136247		
				1 NC	E57EBL8T110EP	136255			
			Plug-in connection M12 x 1	1 N/O	E57EAL8T110ED	136246			
			1 NC	E57EBL8T110ED	136254				
PNP	2 m connection cable	1 N/O	E57EAL8T111EP	136251					
	1 NC	E57EBL8T111EP	136259						
Plug-in connection M12 x 1	1 N/O	E57EAL8T111ED	136250						
1 NC	E57EBL8T111ED	136258							

Technical data	Miniature series E-57		
General			
Standards			IEC/EN 60947-5
Ambient temperature		°C	- 25 - + 70
Protection type			IP67
Mechanical shock resistance		g	30 Shock duration 11 ms
Characteristics			
Repetition accuracy of S_n		%	1
Temperature drift of S_n		%	10
Switching hysteresis of S_n		%	15
Rated operational voltage		U_e	10 - 30 V DC
Operating current in the switched state at 24 V DC	I_b	mA	10
Maximum load current	I_e	mA	200
Voltage drop at I_e	U_d	V	1.5
Switching Frequency		Hz	2000
Residual current through the load in the blocked state at 230 V AC and 24 V DC	I_r	mA	0.01
Switching state display		LED	Red
Protective functions			Short-circuit protective device
Connection			3-wire
Material			Stainless steel

Notes

Further technical data can be found in the Online Catalog at <http://de.ecat.moeller.net>

Engineering

Circuit diagram

Rated operational voltage
3-Wire Sensors
10 – 30 V DC

Contact

2 m connection cable

Plug-in connection M12 (front view plug)

N/O (NPN)

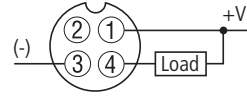
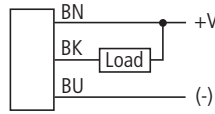

N/O (PNP)

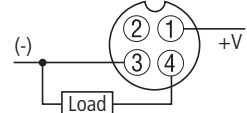
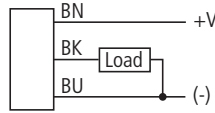

NC (NPN)

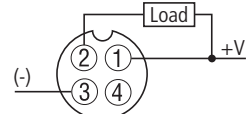
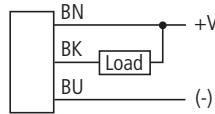

NC (PNP)

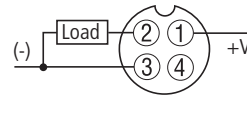
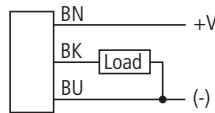

Dimensions

E57EAL4T...

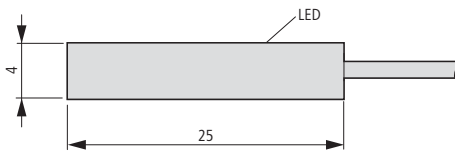

E57EAL5T...

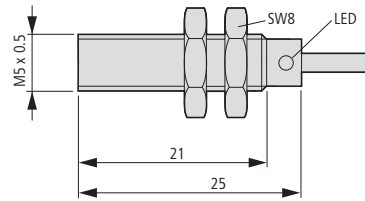

E57EAL6T...

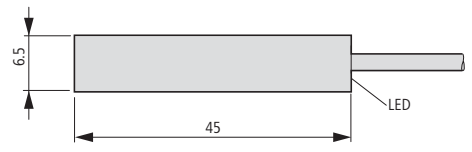

E57...8T...SP

E57...8T...EP

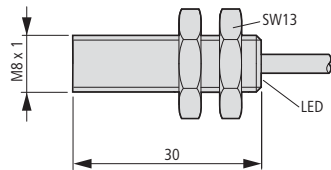

E57...8T...SD

E57...8T...ED

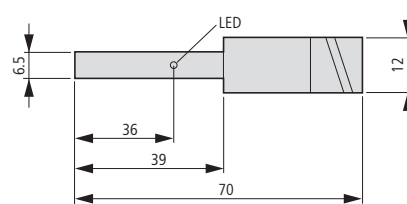

Description

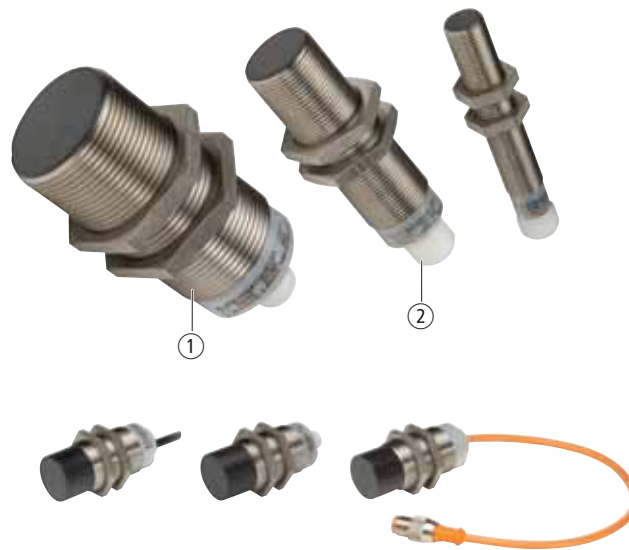

- ① Two-color 360° output signal lamp
② Shock Absorbing Ryton Face Cap Material®

Short Description

The iProx is Eaton's highest-performance and most versatile inductive, cylindrical sensor. With its built-in microprocessor and unique Smart-Sense™ technology this sensor has three times the range of other sensors in its class and offers unique configurability. Both screened and unscreened versions of the sensor have an extended range so that the sensor can be positioned further away from the target object. This reduces the risk of a collision with the target object and increases operational reliability. The iProx also has many extended functions, which can be activated through the optionally available programming tools. With Windows software ProxView the sensor can be programmed for any application. Sensor characteristics such as range can be set to the nearest tenth of a millimeter. The outputs can be configured as N/O or NC. Even interference immunity and response time can be adjusted. In addition the iProx features a built-in logic for deceleration and speed detection – without complex PLC programming. With its large range, high quality, sophisticated design, and adaptability to its environment, iProx is the ideal choice for demanding applications.









Product Features

- Available as DC 3-wire version.
- Reliably detect metal targets at up to three times the range of conventional screened or unscreened tubular inductive sensors
- Quality construction using a stainless steel barrel, 360°-degree dual-color LED indicator, Ryton impact-resistant cap® and vibration-absorbing potting compound.
- The automatic configuration automatically detects NPN and PNP connections and switches the sensor accordingly and without user interaction.
- Configurable range, band detection, background (metal) object detection, deceleration and speed detection thanks to the microprocessor-based Smart-Sense™ technology.
- Optional computer programming cable and Windows-based ProxView configuration software makes it easy to customize sensors.
- Resistant to high interference levels (up to 20 V/m).
- Resistant to extreme temperatures (-40 °C).

Approvals



Ordering

	Rated operational voltage U_e	Rated switching distance S_n mm	Type of mounting	Switching type	For connection of:	Contact configuration N/O = normally open contact N/C = normally closed contact	Material	Part no. Article no.	Price see price list	Std. pack
iProx										
3-wire										
M12 x 1										
	6 - 48 V DC	4	Flush	NPN PNP	2 m connection cable	1 N/O	Stainless steel	E59-M12A105C02-D1 136205	1 off	 
						1 NC		E59-M12A105C02-D2 136206		
			Plug-in connection M12 x 1	1 N/O	E59-M12A105D01-D1 136207					
				1 NC	E59-M12A105D01-D2 136208					
	10	Non-flush	NPN PNP	2 m connection cable	1 N/O	Stainless steel	E59-M12C110C02-D1 136209			
					1 NC		E59-M12C110C02-D2 136210			
		Plug-in connection M12 x 1	1 N/O	E59-M12C110D01-D1 136211						
			1 NC	E59-M12C110D01-D2 136212						
M18 x 1										
	6 - 48 V DC	8	Flush	NPN PNP	2 m connection cable	1 N/O	Stainless steel	E59-M18A108C02-D1 136213	1 off	 
						1 NC		E59-M18A108C02-D2 136214		
			Plug-in connection M12 x 1	1 N/O	E59-M18A108D01-D1 136215					
				1 NC	E59-M18A108D01-D2 136216					
	18	Non-flush	NPN PNP	2 m connection cable	1 N/O	Stainless steel	E59-M18C116C02-D1 136217			
					1 NC		E59-M18C116C02-D2 136218			
		Plug-in connection M12 x 1	1 N/O	E59-M18C116D01-D1 136219						
			1 NC	E59-M18C116D01-D2 136220						
M30 x 1.5										
	6 - 48 V DC	15	Flush	NPN PNP	2 m connection cable	1 N/O	Stainless steel	E59-M30A115C02-D1 136221	1 off	 
						1 NC		E59-M30A115C02-D2 136222		
			Plug-in connection M12 x 1	1 N/O	E59-M30A115D01-D1 136223					
				1 NC	E59-M30A115D01-D2 136224					
	29	Non-flush	NPN PNP	2 m connection cable	1 N/O	Stainless steel	E59-M30C129C02-D1 136225			
					1 NC		E59-M30C129C02-D2 136226			
		Plug-in connection M12 x 1	1 N/O	E59-M30C129D01-D1 136227						
			1 NC	E59-M30C129D01-D2 136228						
Programming cable	-	-	-	-	Plug-in connection M12 x 1	-	E59RP1 136229	-	1 off	
Programming software	-	-	-	-	Plug-in connection M12 x 1	-	E59SW1 136230	-	1 off	

Information relevant for export to North America



Product Standards

UL File No.
UL CCN
CSA File No.

UL 508; CSA-C22.2 No. 14; IEC60947-5-2; CE marking
E166051
NRKH, NRKH7
UL report applies to both Canada and US

CSA Class No.
NA Certification

Max. Voltage Rating
Degree of Protection

UL listed, certified by UL for use in Canada
48 V DC
IEC: IP67, IP69K; UL/CSA Type: 4, 4x, 6, 6P, 12, 13

Technical data

		E59-M12A105	E59-M18A108	E59-M12C110	E59-M30A115	E59-M18C116	E59-M30C129
General							
Standards		IEC/EN 60947-5-2					
Ambient temperature	°C	- 40 - + 70					
Protection type		IP67	IP69K	IP67	IP69K	IP69K	IP69K
Mechanical shock resistance	g	30 Shock duration 11 ms					
Characteristics							
Rated switching distance							
Rated switching distance	S_n mm	4	8	10	15	18	29
Repetition accuracy of S_n	%	1	1	3	1	3	3
Temperature drift of S_n	%	10	10	10	10	10	10
Switching hysteresis of S_n	%	15	15	15	15	15	15
Range	mm	-	-	-	-	-	-
Rated operational voltage	U_e	6 - 48 V DC					
Supply frequency							
Residual ripple of U_e	%	-	-	-	-	-	-
Operating current in the switched state at 24 V DC	I_b mA	15	15	15	15	15	15
Maximum load current	I_e mA	300	300	300	300	300	300
Voltage drop at I_e	U_d V	2.5	2.5	2.5	2.5	2.5	2.5
Switching Frequency	Hz	580	390	300	240	150	145
Min. load current	I_e mA	1	1	1	1	1	1
Short-time current (10 ms, 5 Hz)	A	-	-	-	-	-	-
Residual current through the load in the blocked state at 230 V AC and 24 V DC	I_r mA	0.15	0.15	0.15	0.15	0.15	0.15
Switching state display	LED	Red	Red	Red	Red	Red	Red
Operating voltage display	LED	Green	Green	Green	Green	Green	Green
Boundary gain		-	-	-	-	-	-
Protective functions		Short-circuit protective device					
Connection		3-wire	3-wire	3-wire	3-wire	3-wire	3-wire
Design (outer dimensions)	mm	M12 x 1	M18 x 1	M12 x 1	M30 x 1.5	M18 x 1	M30 x 1.5
Material		Stainless steel	Stainless steel	Stainless steel	Stainless steel	Stainless steel	Stainless steel

Notes

Further technical data can be found in the Online Catalog at <http://de.ecat.moeller.net>

Engineering

Circuit diagram

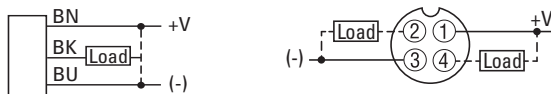
E59...C02-D1
E59...C02-D2E59...D01-D1
E59...D01-D2

Pins 2 and 4 internally interconnected.

Dimensions

2 m connection cable

E59-M...C02...

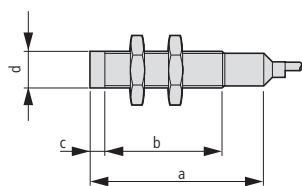

Type	a_x mm (inch)_x	b_x mm (inch)_x	c_x mm (inch)_x	d_x mm (inch)_x
E59-M12A...	62.4 (2.46)	50.3 (1.98)	0.5 (0.02)	_xM12 x 1
E59-M12C...	62.4 (2.46)	41.6 (1.64)	9 (0.35)	_xM12 x 1
E59-M18A...	64.5 (2.54)	50.9 (2.0)	0.5 (0.02)	_xM18 x 1
E59-M18C...	64.5 (2.54)	37.4 (1.47)	14 (0.55)	_xM18 x 1
E59-M30A...	69.6 (2.74)	54.1 (2.13)	0.75 (0.03)	M30 x 1.5
E59-M30CA...	69.6 (2.74)	35.8 (1.41)	19 (0.75)	M30 x 1.5

Plug-in connection M12 x 1

E59-M...D01...

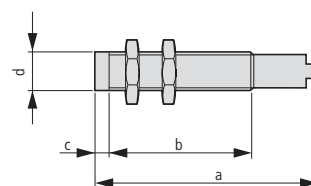

Type	a_x mm (inch)_x	b_x mm (inch)_x	c_x mm (inch)_x	d_x mm (inch)_x
E59-M12A...	68.7 (2.7)	50.3 (1.98)	0.5 (0.02)	_xM12 x 1
E59-M12C...	68.7 (2.7)	41.6 (1.64)	9 (0.35)	_xM12 x 1
E59-M18A...	69.3 (2.73)	50.9 (2.0)	0.5 (0.02)	_xM18 x 1
E59-M18C...	69.3 (2.73)	37.4 (1.47)	14 (0.55)	_xM18 x 1
E59-M30A...	74.1 (2.92)	54.1 (2.13)	0.75 (0.03)	M30 x 1.5
E59-M30CA...	74.1 (2.92)	35.8 (1.41)	19 (0.75)	M30 x 1.5

Description



Short Description

The AccuProx is a high performance analog inductive proximity sensor. The AccuProx family of analog sensors provide unmatched sensing range, linearity and resolution in an affordable and compact tubular enclosure.

Unlike standard inductive sensors, which send an open or close signal upon target presence or absence, AccuProx analog sensors provide an electrical signal that varies in proportion to the position of the metal target within its sensing range.

This makes AccuProx ideal for applications requiring precise position sensing and measurement.

The sensing performance of AccuProx sets it apart from traditional analog inductive designs. Utilizing components from the cutting-edge iProx family, AccuProx provides sensing ranges of three to four times that of typical tubular analog inductive sensors — all without compromising accuracy.

AccuProx has the range and precision to solve your most difficult measurement applications.

Typical Applications

- Part positioning.
- Distance, size and thickness measurement.
- General inspection and error proofing, such as material imperfection or blemish detection.
- Eccentricity or Absolute Angle Detection.
- Identification of different metals.
- Two mounting options for maximum flexibility

Product Features

- Extended linear sensing range of up to 25 millimeters—three times longer than standard tubular analog inductive sensors.
- Current outputs (4-20 or 0-20 mA) and voltage outputs (0-10 V) available.
- High output resolution and repeatability for applications requiring precision sensing performance.
- Robust stainless steel barrel, shock-resistant front cap, polycarbonate end bell and impact-absorbing potting compound.
- Resistant to elevated temperatures and high-pressure sprays - ideal for environments with extreme temperatures and wet areas.
- High noise immunity of 20V/m prevents many problems associated with electrical noise.

Approvals



AccuProx - Powerful analog range in a tried-and-true enclosure

Historically, the range of applications for analog sensors has been severely limited due to short sensing ranges, which rarely exceed one or two millimeters. This, however, has changed with the use of a perfected technology that enables AccuProx sensors to sense objects at distances of up to 25 millimeters, all while maintaining excellent output accuracy levels.

AccuProx utilizes many of the proven materials found in other tubular sensor families. The threaded barrel and included mounting nuts are made of stainless steel, which exhibits superior corrosion and abrasion resistance versus nickel-plated brass. AccuProx also features a proprietary internal potting compound that absorbs impacts and vibration while sealing out moisture. The materials used in the construction of AccuProx are time-tested and proven to work.

High Output Accuracy

Analog inductive sensors are often used in applications that require a higher level of precision than a standard digital sensor. For example, applications such as part inspection require a sensor that can detect very small variances. AccuProx has been designed with these applications in mind.

Output accuracy is determined by the repetition accuracy, resolution, linearity and response time of the sensor.

The **Repetition accuracy** refers to the variations in sensing distance between successive sensor operations due to component tolerances, where all operating conditions are kept the same. The repetition accuracy of an 18 millimeter, unscreened AccuProx sensor is less than 20 micrometers.

Resolution refers to the number of "steps" in the sensor output. A higher resolution is ideal because it will allow the sensor to detect smaller changes in target position.

An 18 millimeter, unscreened AccuProx features more than 350 output steps, ensuring consistent performance.

The **Linearity** refers to the shape of the output curve. Many analog sensors exhibit a wavy or "S-shaped" output curve. This means that a change in target distance may not always translate into an equivalent change in output, particularly at the innermost and outermost ranges of a non-linear analog sensor. AccuProx features a linear output. See the diagram below for an example of AccuProx versus a non-linear sensor.

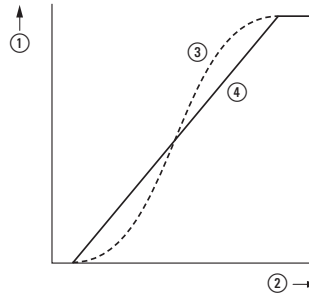

- ① Output
- ② Distance
- ③ Non-linear sensor
- ④ AccuProx Sensor

Typical Analog Applications

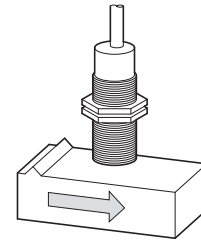



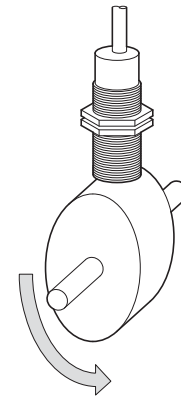



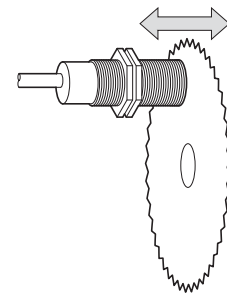

Material Imperfection or Blemish Detection



Eccentricity or Absolute Angle Detection



Saw Blade Deflection

	Design (outer dimensions) mm	Rated switching distance S _n mm	Type of mounting	For connection of:	Description	Part no. Article no.	Price see price list	Std. pack
E59 AccuProx								
3-wire/4-wire Rated operational voltage U _e 15 - 30 V DC Analog Stainless steel								
	M12 x 1	0.5 - 4	Flush	Plug-in connection M12 x 1	Current output (0 - 20 mA) and voltage output (0 - 10 V)	E59-A12A104D01-CV 166834		1 off  
				2 m connection cable		E59-A12A104C02-CV 166832		
		Plug-in connection M12 x 1	Current output (4 - 20 mA)	E59-A12A104D01-C1 166833				
		2 m connection cable		E59-A12A104C02-C1 166831				
	1 - 8	Non-flush	Plug-in connection M12 x 1	Current output (0 - 20 mA) and voltage output (0 - 10 V)	E59-A12C108D01-CV 166838			
			2 m connection cable		E59-A12C108C02-CV 166836			
		Plug-in connection M12 x 1	Current output (4 - 20 mA)	E59-A12C108D01-C1 166837				
		2 m connection cable		E59-A12C108C02-C1 166835				
	M18 x 1	1 - 7	Flush	Plug-in connection M12 x 1	Current output (0 - 20 mA) and voltage output (0 - 10 V)	E59-A18A107D01-CV 166806		1 off  
				2 m connection cable		E59-A18A107C02-CV 166804		
		Plug-in connection M12 x 1	Current output (4 - 20 mA)	E59-A18A107D01-C1 166805				
		2 m connection cable		E59-A18A107C02-C1 166839				
	1 - 15	Non-flush	Plug-in connection M12 x 1	Current output (0 - 20 mA) and voltage output (0 - 10 V)	E59-A18C115D01-CV 166994			
			2 m connection cable		E59-A18C115C02-CV 166807			
		Plug-in connection M12 x 1	Current output (4 - 20 mA)	E59-A18C115D01-C1 166808				
		2 m connection cable		E59-A18C115C02-C1 138201				
	M30 x 1.5	1 - 12	Flush	Plug-in connection M12 x 1	Current output (0 - 20 mA) and voltage output (0 - 10 V)	E59-A30A112D01-CV 166685		1 off  
				2 m connection cable		E59-A30A112C02-CV 166719		
		Plug-in connection M12 x 1	Current output (4 - 20 mA)	E59-A30A112D01-C1 166684				
		2 m connection cable		E59-A30A112C02-C1 166809				
	1 - 25	Non-flush	Plug-in connection M12 x 1	Current output (0 - 20 mA) and voltage output (0 - 10 V)	E59-A30C125D01-CV 166689			
			2 m connection cable		E59-A30C125C02-CV 166687			
		Plug-in connection M12 x 1	Current output (4 - 20 mA)	E59-A30C125D01-C1 166688				
		2 m connection cable		E59-A30C125C02-C1 166686				

Engineering

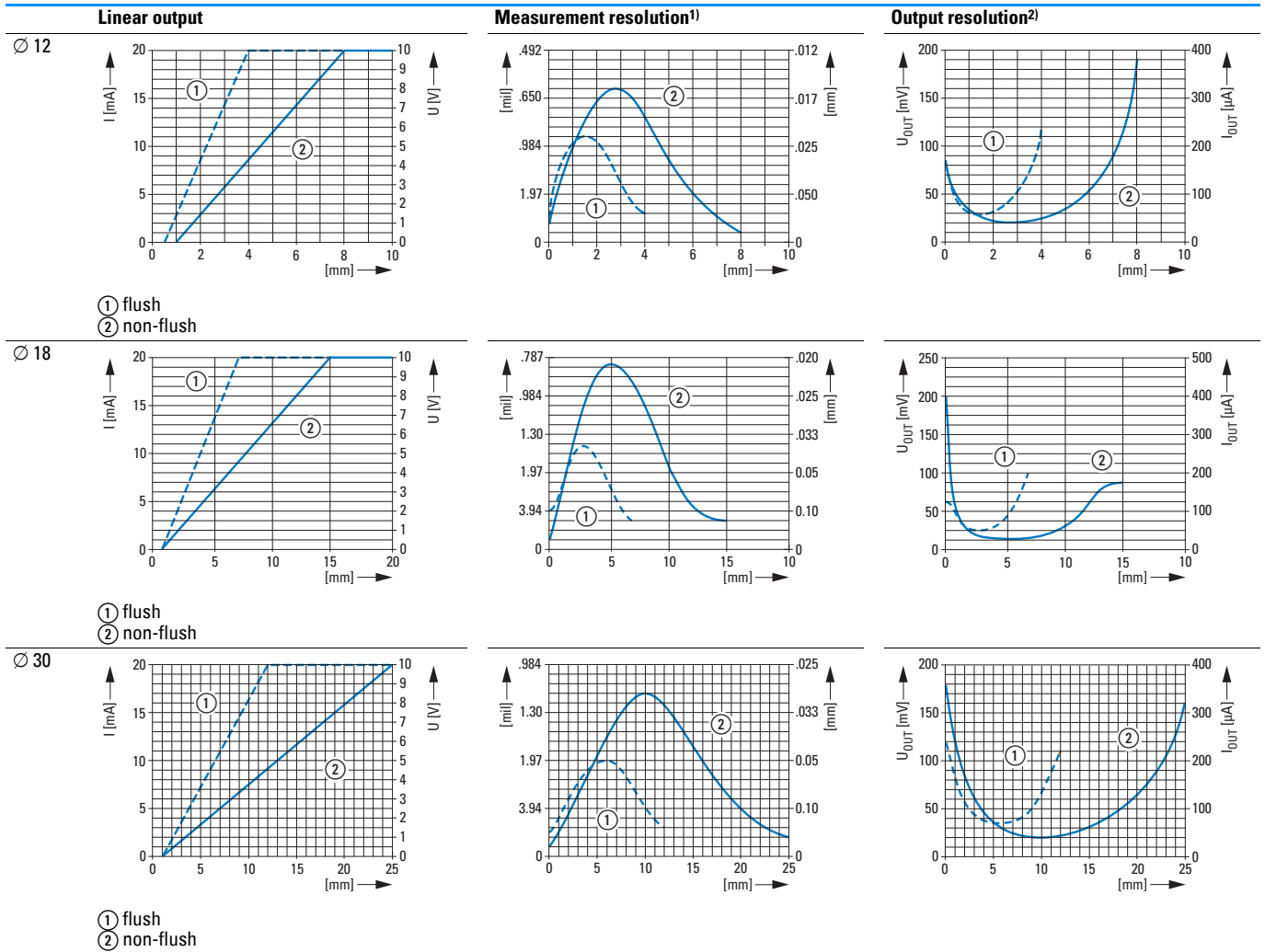

¹⁾Measurement resolution is the sensor's ability to detect a change in target position. The measurement resolution is the finest at the highest point in the curve.
²⁾Output resolution is the change in output signal relative to target position. The minimum change in output resolution is defined by the lowest point in the curve.

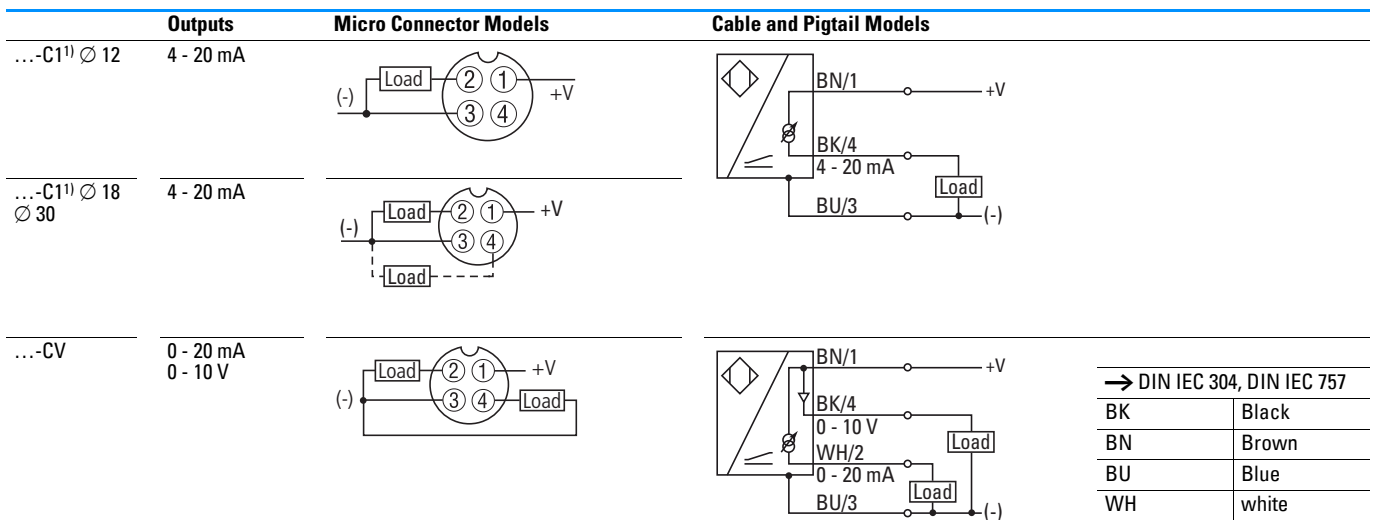

¹⁾ Pins 2 and 4 are internally connected in all models ending in -C1 (models with current output only).
 → Do not connect the outputs of C1 models to different loads—these sensors should only be connected to one single output load!

Technical data

		E59-A12A...	E59-A12C...	E59-A18A...	E59-A18C...	E59-A30A...	E59-A30C...
General							
Standards		IEC/EN 60947-5-2	IEC/EN 60947-5-2	IEC/EN 60947-5-2	IEC/EN 60947-5-2	IEC/EN 60947-5-2	IEC/EN 60947-5-2
Ambient temperature	°C	- 40 - + 70	- 40 - + 70	- 40 - + 70	- 40 - + 70	- 40 - + 70	- 40 - + 70
Protection type		IP67	IP67	IP67	IP67	IP67	IP67
Mechanical shock resistance	g	30 Shock duration 11 ms					
Characteristics							
Rated switching distance	S _n mm	0.5 - 4	1 - 8	1 - 7	1 - 15	1 - 12	1 - 25
Repetition accuracy of S _n	%	3	1	2	1	1	1
Temperature drift of S _n	%	10	10	10	10	10	10
Rated operational voltage	U _e	15 - 30 V DC	15 - 30 V DC	15 - 30 V DC	15 - 30 V DC	15 - 30 V DC	15 - 30 V DC
Switching state display	LED	Red	Red	Red	Red	Red	Red
Operating voltage display	LED	Green	Green	Green	Green	Green	Green
Connection		3-wire/4-wire	3-wire/4-wire	3-wire/4-wire	3-wire/4-wire	3-wire/4-wire	3-wire/4-wire
Design (outer dimensions)	mm	M12 x 1	M12 x 1	M18 x 1	M18 x 1	M30 x 1.5	M30 x 1.5
For connection of:		Plug-in connection M12 x 1					
...D01...		2 m connection cable					
...C02...							
Material		Stainless steel	Stainless steel	Stainless steel	Stainless steel	Stainless steel	Stainless steel

Dimensions

Plug-in connection M12 x 1

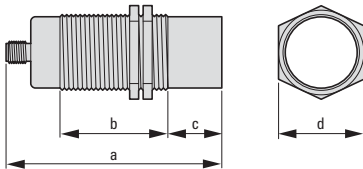

2 m connection cable

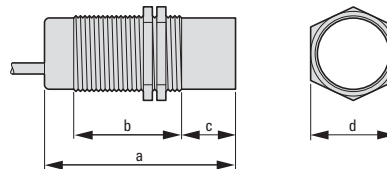

mm		a mm (inch)	b mm (inch)	c mm (inch)	d mm (inch)
∅ 12	①	77.5 (3.05)	50.3 (1.98)	0.5 (0.02)	17 (0.67)
	③	77.5 (3.05)	41.6 (1.64)	9 (0.36)	17 (0.67)
∅ 18	①	69.3 (2.73)	50.9 (2)	0.5 (0.02)	24 (0.94)
	③	69.3 (2.73)	37.4 (1.47)	14 (0.55)	24 (0.94)
∅ 30	①	74.1 (2.92)	54.1 (2.13)	0.75 (0.03)	36 (1.41)
	③	74.1 (2.92)	35.8 (1.41)	19 (0.75)	36 (1.41)

mm		a mm (inch)	b mm (inch)	c mm (inch)	d mm (inch)
∅ 12	①	62.4 (2.46)	50.3 (1.98)	0.5 (0.02)	17 (0.67)
	③	62.4 (2.46)	41.6 (1.64)	9 (0.36)	17 (0.67)
∅ 18	①	64.5 (2.54)	50.9 (2)	0.5 (0.02)	24 (0.94)
	③	64.5 (2.54)	37.4 (1.47)	14 (0.55)	24 (0.94)
∅ 30	①	69.6 (2.74)	54.1 (2.13)	0.75 (0.03)	36 (1.41)
	③	64.5 (2.54)	35.8 (1.41)	19 (0.75)	36 (1.41)

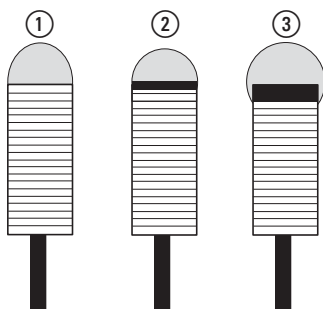

- ① bündig
- ② halbbündig
- ③ nicht bündig

Description

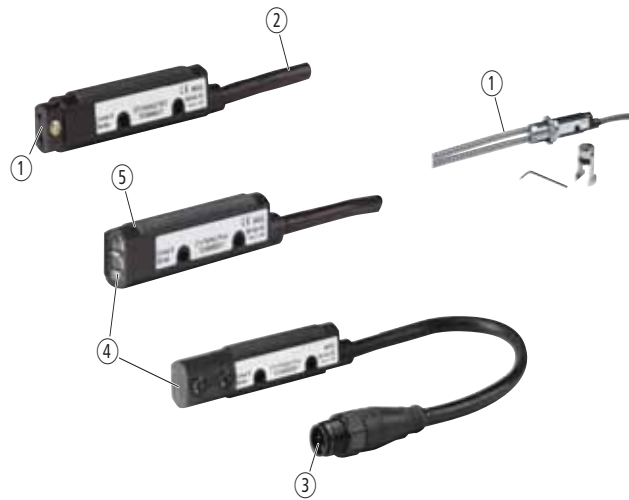

- ① FO cable versions possible.
- ② Bright/dark selector switch on all models.
- ③ Models with M12 plug connector.
- ④ Sensing beam 0° or 90°.
- ⑤ Solid Polyurethane Body for Rugged Use.

Short Description

Eaton's high-performance light barriers feature a tubular enclosure with a diameter of 18 mm and are available in a range of versions to solve virtually any sensing problem. The sensors are available in thru-beam, reflex, polarized reflex, diffuse reflective, focused diffuse reflective, wide-angle diffuse reflective, Perfect Prox[®]_x, Fine Spot Perfect Prox[®]_x and fiber optic sensing versions. Perfect Prox[®]_x light barriers are among the most powerful on the market. These sensors can reliably detect targets of different color, reflectance, contrast or surface shape at the same range, while ignoring background objects just a fraction of an inch away. The Comet model series includes AC/DC and DC-only models with 2-, 3- and 4-wire circuitry, and with cable or M 12 micro-connector. Each light barrier features a Light/ Dark changeover switch and a gain control to provide for quick adjustment to peak optical performance. The unique threaded housing with flat sides allows quick mounting in a 3/4 mm hole or against any flat surface. Internal components are rigidly sealed in a solid encapsulated package for excellent performance in high vibration and high-shock applications.































Product Features

- Industry standard 18 mm diameter threaded body has flat sides allowing it to be mounted like a tubular sensor or against any flat surface.
- Models with a 90° measurement direction can be installed in holes with a depth of only 152 mm.
- Perfect Prox[®]_x technology provides exceptional background rejection and application problem-solving.
- Visible sensing beams let you see where the light barrier is aimed for quick flush mounting and alignment.
- Solid polyurethane housing completely encapsulates internal circuits for high resistance to shock and vibration
- Adaptable modulation circuit provides immunity to crosstalk from other closely mounted sensors
- Models available with both AC and DC operation in a single unit – up to 264 volts AC.
- 4-wire DC sensors offer both NPN and PNP outputs.
- Output status indicator visible from a wide 270° angle.



Approvals







Ordering

	Rated operational voltage U_e	Switching type	Rated switching distance S_n mm	For connection of:	Description	Type of light	Part no. Article no.	Price see price list	Std. pack				
Comet series													
M18 x 1, Light/dark switching adjustable, Insulated material													
3-wire													
Thru-beam photoelectric sensor, Beam: straight													
	20 - 264 V AC 15 - 30 V DC	NPN	6000	2 m connection cable	Detector (for combination with source)	Visible red	12100A6513 135566		1 off  				
				Plug-in connection M12 x 1			12100AQD03 135568						
			24000	2 m connection cable	Source (for combination with detector)	Visible red	12102A6513 135574						
				Plug-in connection M12 x 1			12102AQD03 135576						
		6000	2 m connection cable	Source (for combination with detector)	Visible red	11100A6513 135554		1 off  					
		24000	2 m connection cable			11100AQD03 135556							
			2 m connection cable	Source (for combination with detector)	Visible red	11102A6513 135562				1 off  			
			Plug-in connection M12 x 1			11102AQD03 135564							
Thru-beam photoelectric sensor, Beam: right-angled													
	20 - 264 V AC 15 - 30 V DC	NPN	6000	2 m connection cable	Detector (for combination with source)	Visible red	12100R6513 135570				1 off  		
				Plug-in connection M12 x 1			12100RQD03 135572						
					6000	2 m connection cable	Source (for combination with detector)		Visible red	11100R6513 135558			1 off  
					24000	2 m connection cable				11100RQD03 135560			
			2 m connection cable	Source (for combination with detector)	Visible red	14101A6513 135646		1 off  					
			Plug-in connection M12 x 1			14101AQD03 135648							
Reflex photoelectric sensor, Beam: straight													
	20 - 264 V AC 15 - 30 V DC	NPN	4500	2 m connection cable	Polarized light for combination with reflector	Visible red			14101A6513 135646		1 off  		
				Plug-in connection M12 x 1			14101AQD03 135648						
					7600	2 m connection cable	non-polarized for combination with reflector	Infra-red	14100A6513 135642				1 off  
					24000	2 m connection cable			14100AQD03 135644				
			2 m connection cable	non-polarized for combination with reflector	Visible red	14102A6513 135654		1 off  					
			Plug-in connection M12 x 1			14102AQD03 135656							
Reflex photoelectric sensor, Beam: right-angled													
	20 - 264 V AC 15 - 30 V DC	NPN	3000	2 m connection cable	Polarized light for combination with reflector	Visible red			14101R6513 135650		1 off  		
				Plug-in connection M12 x 1			14101RQD03 135652						
					4500	2 m connection cable	non-polarized for combination with reflector	Visible red	14102R6513 135658				1 off  
					24000	2 m connection cable			14102RQD03 135660				
			2 m connection cable	non-polarized for combination with reflector	Visible red	13102A6513 135590		1 off  					
			Plug-in connection M12 x 1			13102AQD03 135592							
Reflected-light beam, Beam: focused, forward viewing													
	20 - 264 V AC 15 - 30 V DC	NPN	40	2 m connection cable		Visible red			13102A6513 135590		1 off  		
			40	Plug-in connection M12 x 1			13102AQD03 135592						













Information relevant for export to North America

 	Product Standards	UL 508; CSA-C22.2 No. 14; IEC60947-5-2; CE marking
	UL File No.	E117028
	UL CCN	NRKH, NRKH7
	CSA File No.	50513
	CSA Class No.	3211-07
	NA Certification	UL listed, CSA certified
	Max. Voltage Rating	264 V AC, 30 V DC
	Degree of Protection	IEC: IP68, IP69K; UL/CSA Type: 1, 4, 6

	Rated operational voltage U_e	Switching type	Rated switching distance S_n mm	For connection of:	Description	Type of light	Part no. Article no.	Price see price list	Std. pack
Reflected-light beam, Beam: straight									
	20 - 264 V AC 15 - 30 V DC	NPN	50	2 m connection cable	with background suppression (Perfect Prox)	Visible red	13104A6513		1 off  
				Plug-in connection M12 x 1			13104A0D03		
			100	2 m connection cable	with background suppression (Perfect Prox) Fine Spot Sensors	Infra-red	13105A6513		
				Plug-in connection M12 x 1			13105A0D03		
			150	2 m connection cable	Detection of transparent objects	Infra-red	13107AS6513		
				Plug-in connection M12 x 1			13107AS0D03		
			200	2 m connection cable	with background suppression (Perfect Prox)	Infra-red	13108A6513		
				Plug-in connection M12 x 1			13108A0D03		
			225	2 m connection cable	Expandable with fiber optic cable → Accessories	Infra-red	13106A6513		
				Plug-in connection M12 x 1			13106A0D03		
			610	2 m connection cable	with background suppression (Perfect Prox)	Infra-red	13103A6513		
				Plug-in connection M12 x 1			13103A0D03		
			610	2 m connection cable	Expandable with fiber optic cable → Accessories	Infra-red	13100A6513		
				Plug-in connection M12 x 1			13100A0D03		
Reflected-light beam, Beam: right-angled									
	20 - 264 V AC 15 - 30 V DC	NPN	50	2 m connection cable	with background suppression (Perfect Prox)	Visible red	13104R6513		1 off  
				Plug-in connection M12 x 1			13104R0D03		
			100	Plug-in connection M12 x 1	with background suppression (Perfect Prox)	Visible red	13104RS5003		
				2 m connection cable			13104RS5013		
			150	2 m connection cable	Detection of transparent objects	Infra-red	13107RS6513		
				Plug-in connection M12 x 1			13107RS0D03		
			200	2 m connection cable	with background suppression (Perfect Prox)	Infra-red	13108R6513		
				Plug-in connection M12 x 1			13108R0D03		
			225	2 m connection cable	with background suppression (Perfect Prox)	Infra-red	13106R6513		
				Plug-in connection M12 x 1			13106R0D03		
			610	2 m connection cable	with background suppression (Perfect Prox)	Infra-red	13103R6513		
				Plug-in connection M12 x 1			13103R0D03		
			610	2 m connection cable	Expandable with fiber optic cable → Accessories	Infra-red	13100R6513		
				Plug-in connection M12 x 1			13100R0D03		

Information relevant for export to North America



Product Standards	UL 508; CSA-C22.2 No. 14; IEC60947-5-2; CE marking
UL File No.	E117028
UL CCN	NRKH, NRKH7
CSA File No.	50513
CSA Class No.	3211-07
NA Certification	UL listed, CSA certified
Max. Voltage Rating	264 V AC, 30 V DC
Degree of Protection	IEC: IP68, IP69K; UL/CSA Type: 1, 4, 6

	Rated operational voltage U_e	Switching type	Rated switching distance S_n mm	For connection of:	Description	Type of light	Part no. Article no.	Price see price list	Std. pack
Comet series									
M18 x 1, Light/dark switching adjustable, Insulated material									
4-wire									
Thru-beam photoelectric sensor, Beam: straight									
	10 - 30 V DC	NPN PNP	6000	2 m connection cable	Detector (for combination with source)	Visible red	12100A6517 135567		1 off  
				Plug-in connection M12 x 1			12100AQD07 135569		
			24000	2 m connection cable			12102A6517 135575		
				Plug-in connection M12 x 1			12102AQD07 135577		
	6000	NPN PNP	6000	2 m connection cable	Source (for combination with detector)	Visible red	11100A6517 135555		
				Plug-in connection M12 x 1			11100AQD07 135557		
			24000	2 m connection cable			11102A6517 135563		
				Plug-in connection M12 x 1			11102AQD07 135565		
Thru-beam photoelectric sensor, Beam: right-angled									
	10 - 30 V DC	NPN PNP	6000	2 m connection cable	Detector (for combination with source)	Visible red	12100R6517 135571		1 off  
				Plug-in connection M12 x 1			12100RQD07 135573		
				2 m connection cable	Source (for combination with detector)	Visible red	11100R6517 135559		
							Plug-in connection M12 x 1		
Reflex photoelectric sensor, Beam: right-angled									
	10 - 30 V DC	NPN PNP	3000	2 m connection cable	Polarized light for combination with reflector	Visible red	14101R6517 135651		1 off  
				Plug-in connection M12 x 1			14101RQD07 135653		
			4500	2 m connection cable	non-polarized for combination with reflector	14102R6517 135659			
				Plug-in connection M12 x 1		14102RQD07 135661			
Reflex photoelectric sensor, Beam: straight									
	10 - 30 V DC	NPN PNP	4500	2 m connection cable	Polarized light for combination with reflector	Visible red	14101A6517 135647		1 off  
				Plug-in connection M12 x 1			14101AQD07 135649		
			7600	2 m connection cable	non-polarized for combination with reflector	14100A6517 135643			
				Plug-in connection M12 x 1		14100AQD07 135645			
			2 m connection cable	Visible red	14102A6517 135655				
					Plug-in connection M12 x 1	14102AQD07 135657			

Information relevant for export to North America





Product Standards	UL 508; CSA-C22.2 No. 14; IEC60947-5-2; CE marking
UL File No.	E117028
UL CCN	NRKH, NRKH7
CSA File No.	50513
CSA Class No.	3211-07
NA Certification	UL listed, CSA certified
Max. Voltage Rating	30 V DC
Degree of Protection	IEC: IP68, IP69K; UL/CSA Type: 1, 4, 6

	Rated operational voltage U_e	Switching type	Rated switching distance S_n mm	For connection of:	Description	Type of light	Part no. Article no.	Price see price list	Std. pack	
Comet series										
M18 x 1, Light/dark switching adjustable, Insulated material										
	10 - 30 V DC	NPN PNP	40	2 m connection cable	with background suppression (Perfect Prox)	Visible red	13102A6517 135591		1 off  	
				Plug-in connection M12 x 1						13102AQD07 135593
			50	2 m connection cable	with background suppression (Perfect Prox)	Visible red	13104A6517 135603			
				Plug-in connection M12 x 1						13104AQD07 135605
				2 m connection cable	with background suppression (Perfect Prox) Fine Spot Sensors		13105A6517 135615			
				Plug-in connection M12 x 1						13105AQD07 135617
			100	2 m connection cable	with background suppression (Perfect Prox)	Infra-red	13101A6517 135587			
				Plug-in connection M12 x 1						13101AQD07 135589
			150	2 m connection cable	Detection of transparent objects		13107AS6517 135627			
				Plug-in connection M12 x 1						13107ASQD07 135629
				2 m connection cable						with background suppression (Perfect Prox)
			Plug-in connection M12 x 1	13108AQD07 135637						
			200	2 m connection cable	Expandable with fiber optic cable → Accessories		13106A6517 135619			
				Plug-in connection M12 x 1						13106AQD07 135621
225	2 m connection cable	with background suppression (Perfect Prox)		13103A6517 135595						
	Plug-in connection M12 x 1					13103AQD07 135597				
610	2 m connection cable	Expandable with fiber optic cable → Accessories		13100A6517 135579						
	Plug-in connection M12 x 1					13100AQD07 135581				

Information relevant for export to North America

Product Standards	UL 508; CSA-C22.2 No. 14; IEC60947-5-2; CE marking
UL File No.	E117028
UL CCN	NRKH, NRKH7
CSA File No.	50513
CSA Class No.	3211-07
NA Certification	UL listed, CSA certified
Max. Voltage Rating	30 V DC
Degree of Protection	IEC: IP68, IP69K; UL/CSA Type: 1, 4, 6

	Rated operational voltage U_e	Switching type	Rated switching distance S_n mm	For connection of:	Description	Type of light	Part no. Article no.	Price see price list	Std. pack
Comet series									
M18 x 1, Light/dark switching adjustable, Insulated material									
	10 - 30 V DC	NPN PNP	50	2 m connection cable	with background suppression (Perfect Prox)	Visible red	13104R6517 135607		1 off 
				Plug-in connection M12 x 1			13104RQD07 135609		
			100	Plug-in connection M12 x 1		13104RS5007 135611			
				2 m connection cable		13104RS5020 135613			
			150	2 m connection cable	Detection of transparent objects	Infra-red	13107RS6517 135631		
				Plug-in connection M12 x 1			13107RSQD07 135633		
				2 m connection cable	with background suppression (Perfect Prox)	13108R6517 135639			
				Plug-in connection M12 x 1		13108RQD07 135641			
			200	2 m connection cable			13106R6517 135623		
				Plug-in connection M12 x 1			13106RQD07 135625		
			225	2 m connection cable	with background suppression (Perfect Prox)		13103R6517 135599		
				Plug-in connection M12 x 1			13103RQD07 135601		
			610	2 m connection cable			13100R6517 135583		
				Plug-in connection M12 x 1			13100RQD07 135585		

Information relevant for export to North America

Product Standards	UL 508; CSA-C22.2 No. 14; IEC60947-5-2; CE marking
UL File No.	E117028
UL CCN	NRKH, NRKH7
CSA File No.	50513
CSA Class No.	3211-07
NA Certification	UL listed, CSA certified
Max. Voltage Rating	30 V DC
Degree of Protection	IEC: IP68, IP69K; UL/CSA Type: 1, 4, 6

Description



Short Description

Eaton's Plastic Fiber Optic Cables from offer a lower-cost alternative to glass fibers.











Single fiber optic cable is normally used for thru-beam sensing and duplex fiber optic cable (two isolated cables running in parallel) for diffuse reflective.















Pre-assembled fiber optic cables are special purpose cables to solve a variety of fiber optic sensing applications.

Product Features

- Fiber optic cables allow remote sensing in areas where space is restricted or tight viewing angles are required
- Single cable styles are ideal for thru-beam sensing.
- Duplex fiber optic cable styles are typically used for diffuse reflective sensing
- Pre-assembled cables are available in 0.5 mm for sensing extremely small targets

Ordering

	Design (outer dimensions) mm	Material	Sheathing	Part no. Article no.	Price see price list	Std. pack
Glass fibre-Component adapter						
In combination with reflex sensors 13106A... or 13100A... and E51KF fiber optic						
	-	Metal	-	6235A-6501 135759		1 off
Glass fiber duplex cable						
	2.4 Ø x 914	-	PVC	E51KF163 135761		1 off
	2.4 Ø x 914	-	Stainless steel	E51KF563 135783		
	1.6 Ø x 914	-	PVC	E51KF183 135763		
	1.6 Ø x 914	-	Stainless steel	E51KF583 135785		
	0.5 x 3.9 Ø x 914	-	PVC	E51KF193 135764		
	0.5 x 3.9 Ø x 914	-	Stainless steel	E51KF593 135786		
	3.2 Ø x 914	-	PVC	E51KF323 135771		
	3.2 Ø x 914	-	Stainless steel	E51KF723 135793		
	3.2 Ø x 914	-	PVC	E51KF313 135770		
	3.2 Ø x 914	-	Stainless steel	E51KF713 135792		
	0.8 x 9.7 Ø x 914	-	PVC	E51KF343 135773		
	0.8 x 9.7 Ø x 914	-	Stainless steel	E51KF743 135795		
	0.5 x 3.9 Ø x 914	-	Stainless steel	E51KF553 135782		
	0.5 x 3.9 Ø x 914	-	PVC	E51KF153 135760		
	1.6 Ø x 914	-	Stainless steel	E51KF573 135784		
	3.2 Ø x 914	-	Stainless steel	E51KF733 135794		
	1.6 Ø x 914	-	PVC	E51KF173 135762		
	3.2 Ø x 914	-	PVC	E51KF333 135772		
	3.2 Ø x 914	-	Stainless steel	E51KF7A3 135796		
	3.2 Ø x 914	-	PVC	E51KF3A3 135774		
	3.2 Ø x 914	-	Stainless steel	E51KF7B3 135797		
	3.2 Ø x 914	-	PVC	E51KF3B3 135775		

	Design (outer dimensions) mm	Material	Sheathing	Part no. Article no.	Price see price list	Std. pack
Glass fiber simplex cable						
	2.4 Ø x 914	-	Stainless steel	E51KF663 135788		1 off
	2.4 Ø x 914	-	PVC	E51KF263 135766		
	1.6 Ø x 914	-	Stainless steel	E51KF683 135790		
	1.6 Ø x 914	-	PVC	E51KF283 135768		
	0.5 x 3.9 Ø x 914	-	Stainless steel	E51KF693 135791		
	3.2 Ø x 914	-	Stainless steel	E51KF823 135799		
	3.2 Ø x 914	-	PVC	E51KF423 135777		
	0.5 x 3.9 Ø x 914	-	PVC	E51KF293 135769		
	3.2 Ø x 914	-	Stainless steel	E51KF813 135798		
	3.2 Ø x 914	-	PVC	E51KF413 135776		
	0.8 x 9.7 Ø x 914	-	Stainless steel	E51KF843 135801		
	0.8 x 9.7 Ø x 914	-	PVC	E51KF443 135779		
	0.5 x 3.9 Ø x 914	-	Stainless steel	E51KF653 135787		
	0.5 x 3.9 Ø x 914	-	PVC	E51KF253 135765		
	1.6 Ø x 914	-	Stainless steel	E51KF673 135789		
	3.2 Ø x 914	-	Stainless steel	E51KF833 135800		
	1.6 Ø x 914	-	PVC	E51KF273 135767		
	3.2 Ø x 914	-	PVC	E51KF433 135778		
	3.2 Ø x 914	-	Stainless steel	E51KF8A3 135802		
	3.2 Ø x 914	-	PVC	E51KF4A3 135780		
	3.2 Ø x 914	-	Stainless steel	E51KF8B3 135803		
	3.2 Ø x 914	-	PVC	E51KF4B3 135781		
Safety bar						
	-	Metal	-	E58KS5200 135757		1 off
Fixing bracket						
	53 x 44	Stainless steel	-	6161AS5296 135738		1 off
	53 x 44	Stainless steel	-	6161AS5297 135739		1 off

Engineering

Circuit diagrams

AC/DC Models (AC Connection)

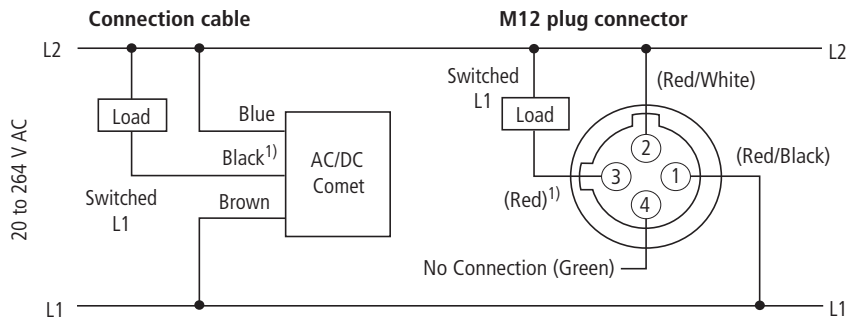

1) Note: Cable not connected on source of thru-beam sensors.

AC/DC Models (DC Connection)

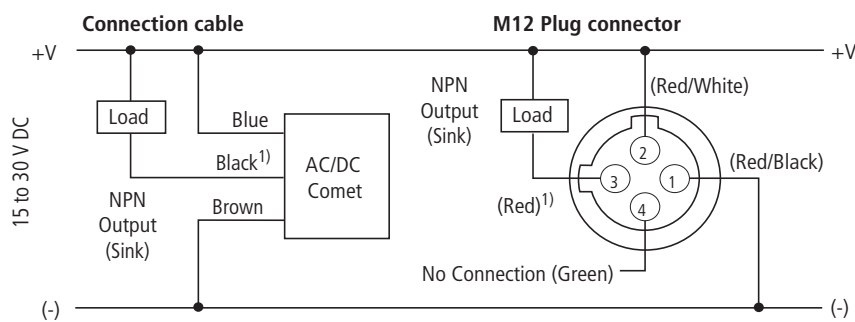

1) Note: Cable not connected on source of thru-beam sensors.

DC Models (DC Connection)

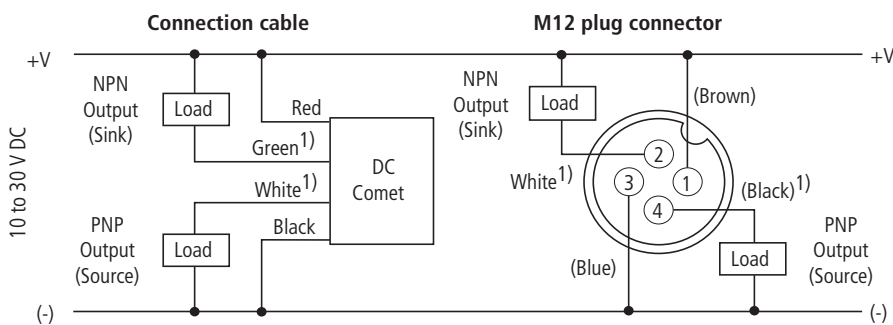

1) Note: Cable not connected on source of thru-beam sensors.

Note: AC/DC sensors have AC plug connectors. Take into account when using with DC voltage.

Excess gain chart

Thru-beam photoelectric sensor

- ① Detector 12100A and 12100R with source 11100A or 11100R
- ② Detector 12102A with source 11102A

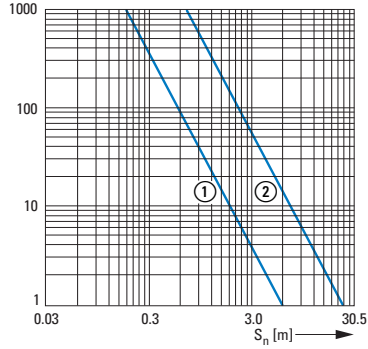

Retroreflective sensing sensor (84-mm-Reflector)

- ① 14100A/14102A
- ② 14102R
- ③ 14101A
- ④ 14101R

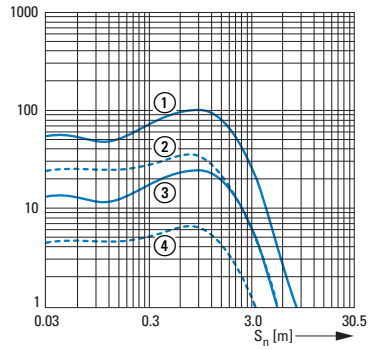

Diffuse reflective sensor (90% reflex test card)

- ⑤ 13107
- ⑥ 13100
- ⑦ 13106

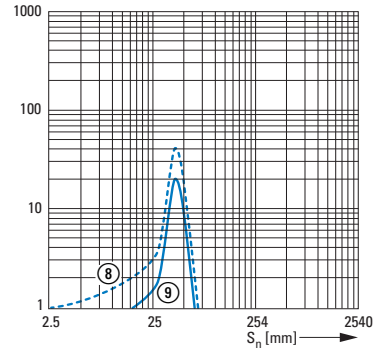
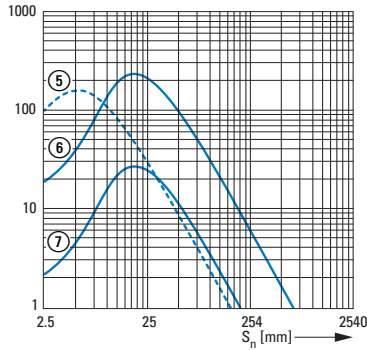

Focused diffuse reflective sensor (90% reflex test card)

- ⑧ 13102A typ.
- ⑨ 13102A minimum

Perfect Prox®

- ① 13108A/13108R
- ② 13104A
- ③ 14104RS
- ④ 13103A/13103R
- ⑤ 13101A typ.
- ⑥ 13101A minimum
- ⑦ 13102A typ.
- ⑧ 13102A min.
- ⑨ 13105A typ.
- ⑩ 13105A minimum

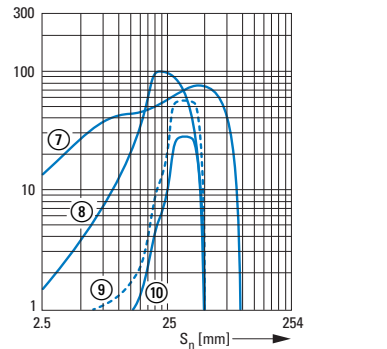
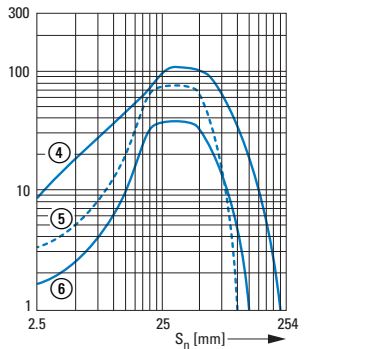
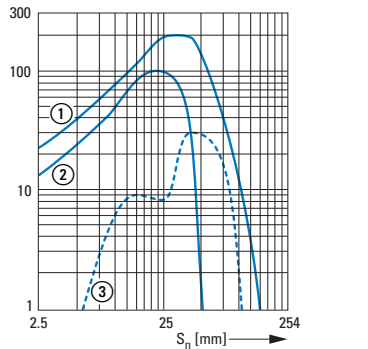

Fibre optic sensors

Thru-beam photoelectric sensor

- With single FO cable E51KF823
- ① 13100A Comet
- ② 13106A Comet

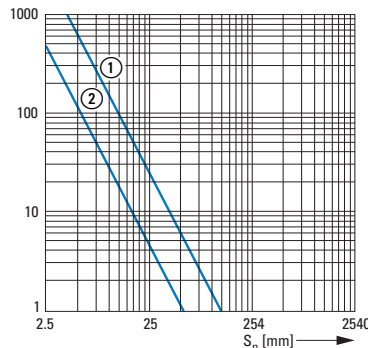

Diffuse reflective sensor

- With duplex FO cable E51KF723
- ③ 13100A Comet
- ④ 13106A Comet

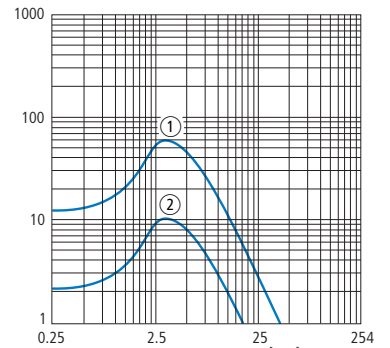

Technical data

			3-wire 111-Part no.	121 Part no.	131-Part no.	141-Part no.
General						
Standards			IEC/EN 60947-5-2			
Ambient temperature		°C	- 20 - + 70	- 20 - + 70	- 40 - + 70	- 40 - + 70
Protection type			IP67	IP67	IP67	IP67
Mechanical shock resistance		g	100 Shock duration 3 ms			
Characteristics						
Rated operational voltage		U _e	20 - 264 V AC 15 - 30 V DC	20 - 264 V AC 15 - 30 V DC	20 - 264 V AC 15 - 30 V DC	20 - 264 V AC 15 - 30 V DC
Operating current in the switched state at 24 V DC	I _b	mA	30	30	30	30
Maximum load current	I _e	mA	< 300	< 300	< 300	< 300
Response time		ms	10	10	10	10
Switching state display		LED	Red	Red	Red	Red
Operating voltage display		LED	-	-	-	-
Protective functions			Short-circuit protective device Protection against polarity reversal			
Connection			3-wire	3-wire	3-wire	3-wire
Design (outer dimensions)		mm	M18 x 1	M18 x 1	M18 x 1	M18 x 1
For connection of:			2 m connection cable			
Material			Insulated material			

			4-wire 111-Part no.	121 Part no.	131-Part no.	141-Part no.
General						
Standards			IEC/EN 60947-5-2			
Ambient temperature		°C	- 20 - + 70	- 20 - + 70	- 40 - + 70	- 40 - + 70
Protection type			IP67	IP67	IP67	IP67
Mechanical shock resistance		g	100 Shock duration 3 ms			
Characteristics						
Rated operational voltage		U _e	10 - 30 V DC	10 - 30 V DC	10 - 30 V DC	10 - 30 V DC
Operating current in the switched state at 24 V DC	I _b	mA	25	30	30	30
Maximum load current	I _e	mA	PNP: 100 NPN: 250 (120 > 55 °C)	PNP: 100 NPN: 250 (120 > 55 °C)	PNP: 100 NPN: 250 (120 > 55 °C)	PNP: 100 NPN: 250 (120 > 55 °C)
Response time		ms	3.5	3.5	1	1
Switching state display		LED	-	Red	Red	Red
Operating voltage display		LED	red	-	-	-
Protective functions			Short-circuit protective device Protection against polarity reversal			
Connection			4-wire	4-wire	4-wire	4-wire
Design (outer dimensions)		mm	M18 x 1	M18 x 1	M18 x 1	M18 x 1
For connection of:			2 m connection cable			
Material			Insulated material			

Notes

Further technical data can be found in the Online Catalog at <http://de.ecat.moeller.net>

Dimensions

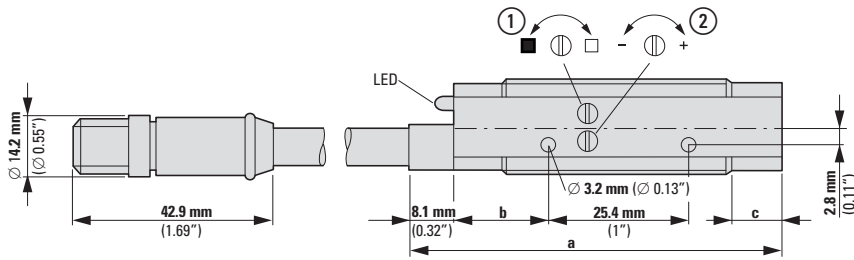

- ① Brightness setting
- ② Gain adjustment

Type	a_x mm (inch)_x	b_x mm (inch)_x	c_x mm (inch)_x	d_x mm (inch)_x	Settings		Enclosure style
					① Light/dark	② Gain	
11100A...	56 (2.2)	17 (0.67)	6 (0.24)	-	-	-	2
11100R...	65 (2.56)	17 (0.67)	15 (0.59)	5 (0.197)	-	-	4
11102A...	70 (2.78)	17 (0.67)	28 (1.10)	-	-	-	1
12100A...	56 (2.2)	17 (0.67)	6 (0.24)	-	x	x	2
12100R...	65 (2.56)	17 (0.67)	15 (0.59)	5 (0.197)	x	x	4
12102A...	66 (2.60)	15 (0.59)	7 (0.28)	-	x	x	1
13100A..., 13106A...	56 (2.2)	17 (0.67)	6 (0.24)	-	x	x	2
13100R..., 13106R...	65 (2.56)	17 (0.67)	15 (0.59)	5 (0.197)	x	x	4
13101A..., 13104A...	66 (2.60)	15 (0.59)	6 (0.24)	-	x	-	1
13102A..., 13103A..., 13105A..., 13108A...	66 (2.60)	15 (0.59)	6 (0.24)	-	x	x	1
13104R...	77 (3.03)	15 (0.59)	28 (1.10)	5 (0.197)	x	-	6
14100A..., 14102A...	66 (2.60)	15 (0.59)	7 (0.28)	-	x	x	1
14101R..., 14102R...	76 (2.99)	15 (0.59)	18 (0.71)	5 (0.197)	x	x	5
14101A...	67 (2.64)	15 (0.59)	7 (0.28)	-	x	x	1
15100A..., 15101A...	73 (2.87)	15 (0.59)	15 (0.59)	-	x	x	3

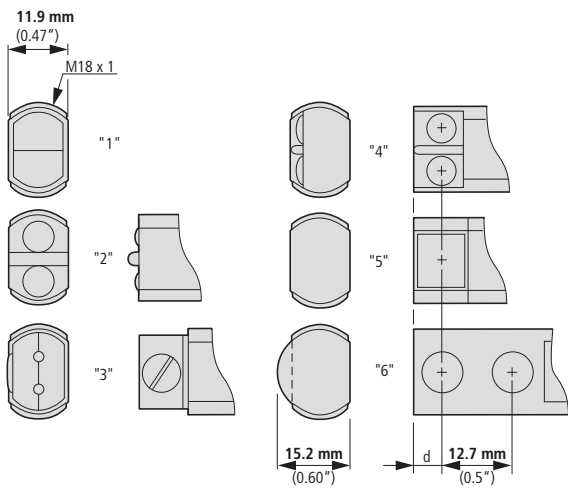

Enclosure style

Type	S_xn_x mm (inch)_x
13104A..., 13104R6..., 13104RQ..., 131055_x	50 (1.97)
13104RS..., 13101..._X	100 (3.94)
13107..., 13108...	150 (5.91)
13106...	200 (7.87)
13103...	225 (8.86)
13100...	610 (24.02)
14101R...	3000 (118.11)
14101A..., 14102R..._x	4500 (177.17)
11100..., 12100...	6000 (236.22)
14100A..., 14102A...	7600 (299.21)
11102..., 12102...	24000 (944.88)

Glass fiber duplex cable

E51KF313
E51KF713

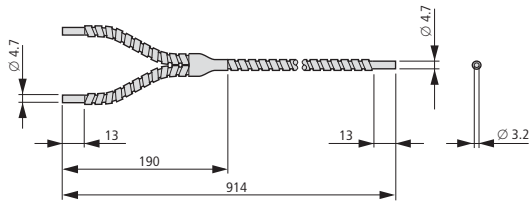

E51KF3B3
E51KF7B3

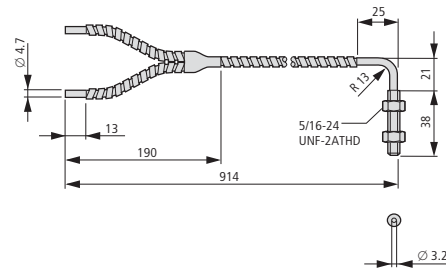

E51KF333
E51KF733

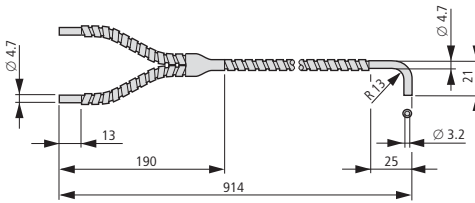

E51KF163
E51KF563

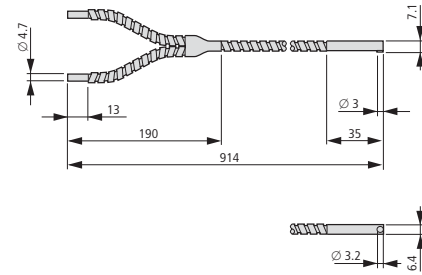

E51KF323
E51KF723

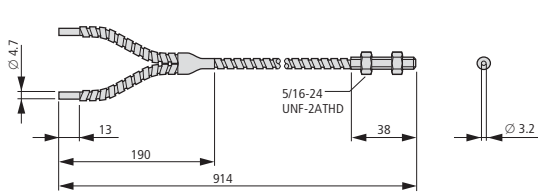

E51KF183
E51KF583

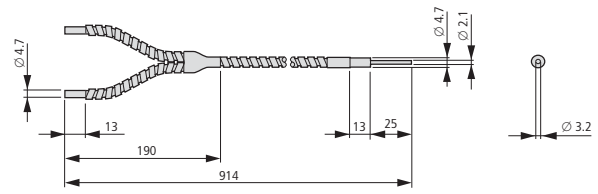

E51KF193
E51KF593

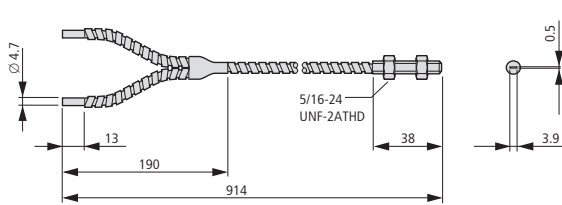

E51KF173
E51KF573

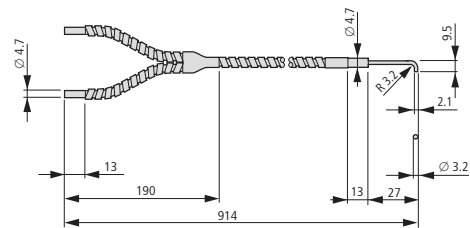

E51KF3A3
E51KF7A3

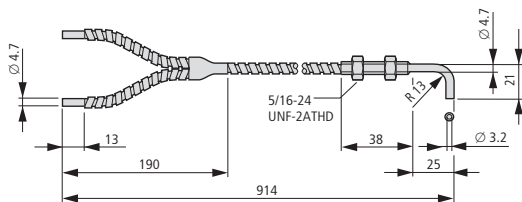

E51KF343
E51KF743



E51KF153
E51KF553

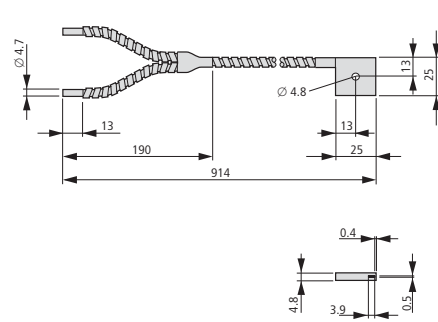

Glass fiber simplex cable

E51KF413
E51KF813

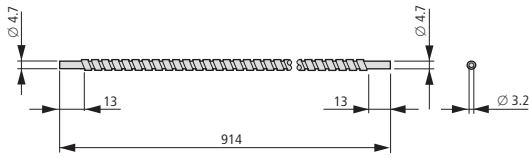

E51KF4B3
E51KF8B3

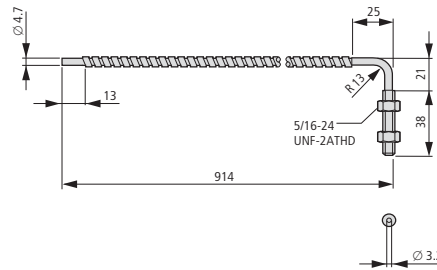

E51KF433
E51KF833

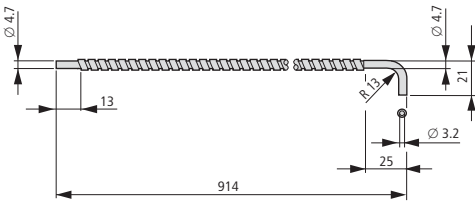

E51KF263
E51KF663

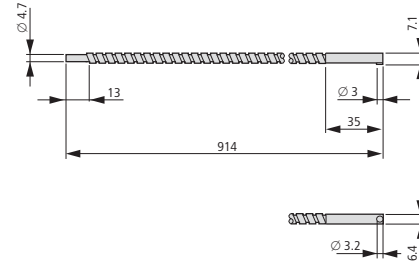

E51KF423
E51KF823

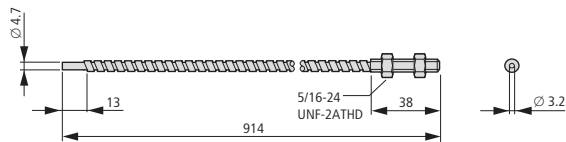

E51KF283
E51KF683

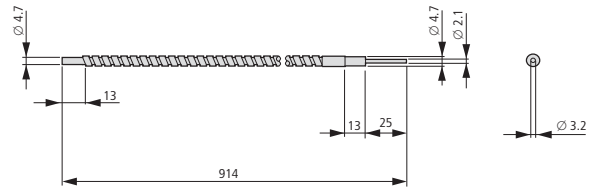

E51KF293
E51KF693

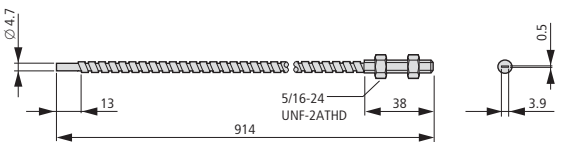

E51KF273
E51KF673

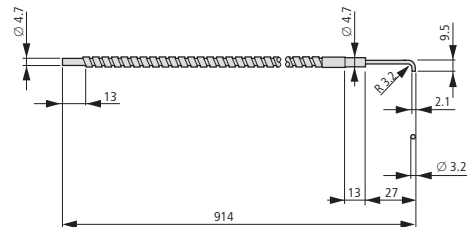

E51KF4A3
E51KF8A3

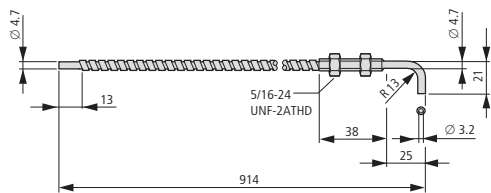

E51KF443
E51KF843



E51KF253
E51KF653

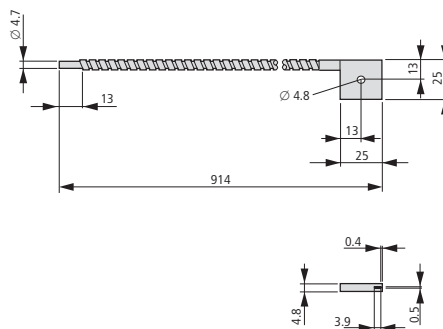

Safety bar, adjustable

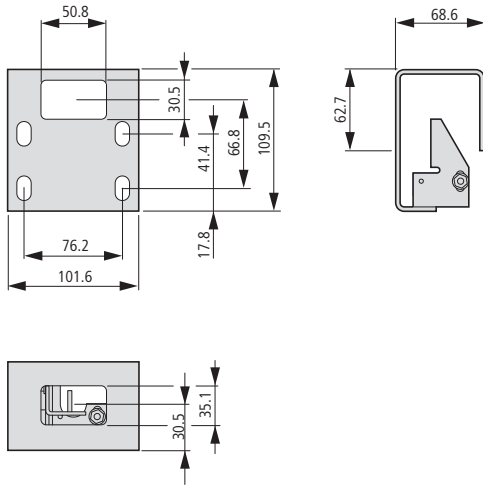

Clip-type fixing bracket, increased

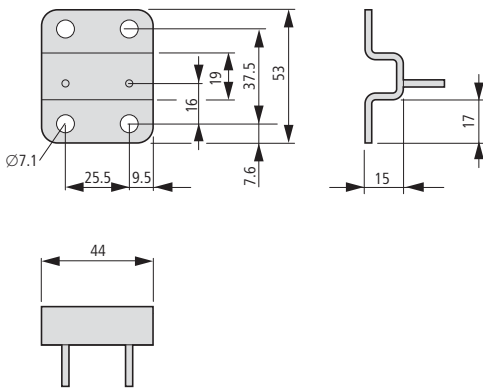

Clip-type fixing bracket, flat

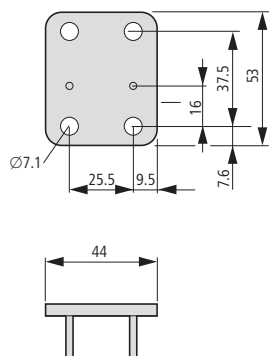

Description



- ① Tempered Glass Lens Cover Protects Against Abrasion.
- ② Bright 360° function display.
- ③ All models with visible red light.
- ④ All models are available in versions with M12 (micro) plug connector.

Short Description





Eaton's E58 series was designed to withstand harshest physical, chemical and optical environments. Stainless steel, PVDF and tempered glass components are mechanically assembled using Viton® seals to ensure complete sealing and resistance to industry chemicals. All adhesives and potting subject to failure from chemical attack have been eliminated from the design. The result is a sensor highly resistant to chemical attack and moisture intrusion, that can withstand heavy shock and vibration in almost any application. E58 Harsh Duty sensors feature unparalleled optical performance. They are ideal for automotive applications where exposure to lubricants, cutting fluids, coolants and glycols is common. For food processing applications, a smooth housing version simplifies high-pressure chemical washdowns. Furthermore it withstands the use of sanitizers, surfactants, and cleaning agents including diluted bases and acids.

Product Features

- Sensor with a diameter of 18 mm and 30 mm.
- Highly refined optics for long sensing ranges and to see through high levels of contamination – unmatched optical performance
- Perfect Prox® technology provides exceptional background rejection and extremely high excess gain.
- Resistant to the wide range of chemicals used in the automotive, food processing and forest products industries
- Suitable for high temperature, high pressure washdown (82 bar).
- Mechanical Viton gaskets are resistant to extreme temperature variations.
- Visible sensing beam on all models lets you see where the beam is aimed for quick flush mounting and alignment.
- The function display is the brightest available and is visible from any angle and in any lighting condition
- The industry's only background suppression sensors with a 2-wire circuit design
- Four-wire DC sensors feature an NPN and a PNP output

Approvals









Con- nection	Design (outer dimen- sions) mm	Rated operational voltage U _e	Rated switching distance S _n mm	Switch- ing type	Switching principle	For connection of:	Type of light	Part no. Article no.	Price see price list	Std. pack
E58										
Stainless steel										
Reflected-light beam with background suppression (Perfect Prox)										
	2-wire	M18 x 1	18 - 50 V DC	50	-	Dark switching	Plug-in connection M12 x 1	Visible red		1 off  
					-	Light switching				
					-	Dark switching				
					-	Light switching				
					-	Dark switching				
					-	Light switching				
M30 x 1.5	150	-	Dark switching	Plug-in connection M12 x 1	Visible red		1 off  			
		-	Light switching							
		-	Dark switching							
		-	Light switching							
		-	Dark switching							
		-	Light switching							













Information relevant for export to North America



Product Standards
UL File No.
UL CCN
CSA File No.
CSA Class No.
NA Certification
Max. Voltage Rating
Degree of Protection

UL 508; CSA-C22.2 No. 14; IEC60947-5-2; CE marking
E166051
NRKH, NRKH7
UL report applies to both Canada and US
-
UL listed, certified by UL for use in Canada
50 V DC
IEC: IP68, IP69K; UL/CSA Type: 1, 2, 3, 3R, 3S, 4, 4x, 6, 6P, 12, 12K, 13

Con- nection	Design (outer dimen- sions) mm	Rated operational voltage U _e	Rated switching distance S _n mm	Switch- ing type	Switching principle	For connection of:	Type of light	Part no. Article no.	Price see price list	Std. pack				
E58														
Stainless steel														
Reflected-light beam with background suppression (Perfect Prox)														
	4-wire	M18 x 1	10 - 30 V DC	50	NPN PNP	Dark switching	2 m connection cable	Visible red		1 off  				
						Light switching	2 m connection cable							
						Dark switching	2 m connection cable							
						Light switching	2 m connection cable							
						Dark switching	2 m connection cable							
						Light switching	2 m connection cable							
				M30 x 1.5	150	NPN PNP	Dark switching				2 m connection cable	Visible red		1 off  
							Light switching				2 m connection cable			
							Dark switching				2 m connection cable			
							Light switching				2 m connection cable			
							Dark switching				2 m connection cable			
							Light switching				2 m connection cable			
280	NPN PNP	Dark switching	2 m connection cable	Visible red		1 off  								
		Light switching	2 m connection cable											
		Dark switching	2 m connection cable											
		Light switching	2 m connection cable											
		Dark switching	2 m connection cable											
		Light switching	2 m connection cable											

	Con- nection	Design (outer dimen- sions) mm	Rated operational voltage U _e	Rated switching distance S _n mm	Switch- ing type	Switching principle	For connection of:	Type of light	Part no. Article no.	Price see price list	Std. pack
E58											
Stainless steel											
Reflex photoelectric sensor											
Polarized light											
for combination with reflector											
	4-wire	M30 x 1.5	10 - 30 V DC	10000	NPN PNP	Dark switching	2 m connection cable Plug-in connection M12 x 1	Visible red	E58-30RP10-HD 135684		1 off  
						Light switching	2 m connection cable Plug-in connection M12 x 1		E58-30RP10-HDP 135685		
								E58-30RP10-HL 135686			
								E58-30RP10-HLP 135687			
Reflex photoelectric sensor											
for combination with reflector											
	4-wire	M30 x 1.5	10 - 30 V DC	18000	NPN PNP	Dark switching	2 m connection cable Plug-in connection M12 x 1	Visible red	E58-30RS18-HD 135688		1 off  
						Light switching	2 m connection cable Plug-in connection M12 x 1		E58-30RS18-HDP 135689		
								E58-30RS18-HL 135690			
								E58-30RS18-HLP 135691			
Thru-beam photoelectric sensor											
Detector (for combination with source)											
	4-wire	M30 x 1.5	10 - 30 V DC	250000	NPN PNP	Dark switching	2 m connection cable Plug-in connection M12 x 1	-	E58-30TD250-HD 135692		1 off  
						Light switching	2 m connection cable Plug-in connection M12 x 1		E58-30TD250-HDP 135693		
								E58-30TD250-HL 135694			
								E58-30TD250-HLP 135695			
Thru-beam photoelectric sensor											
Source (for combination with detector)											
	4-wire	M30 x 1.5	10 - 30 V DC	250000	NPN PNP	- -	2 m connection cable Plug-in connection M12 x 1	Visible red	E58-30TS250-HA 135696		1 off  
									E58-30TS250-HAP 135697		

Information relevant for export to North America



Product Standards
UL File No.
UL CCN
CSA File No.
CSA Class No.
NA Certification
Max. Voltage Rating
Degree of Protection

UL 508; CSA-C22.2 No. 14; IEC60947-5-2; CE marking
E166051
NRKH, NRKH7
UL report applies to both Canada and US
-
UL listed, certified by UL for use in Canada
30 V DC
IEC: IP68, IP69K; UL/CSA Type: 1, 2, 3, 3R, 3S, 4, 4x, 6, 6P, 12, 12K, 13

Engineering

Circuit diagrams

E58...HA

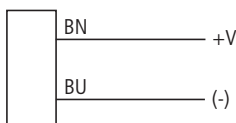

E58...HAP

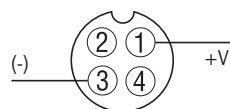

E58...DDP, E58...DLP

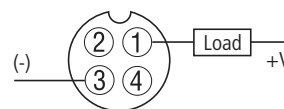

E58...HD

E58...HL

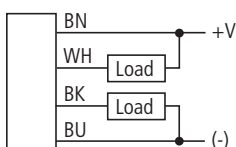

E58...HDP

E58...HLP

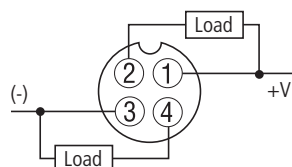

Excess gain chart

- One-way light barrier**
 ① One-way light barrier
Reflex
 ② 84-mm-Reflector
Polarized reflex
 ③ 84-mm-Reflector

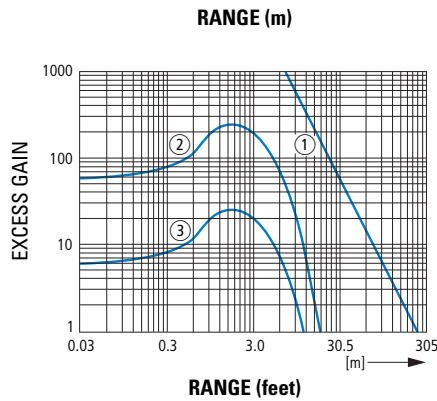

- Perfect Prox®**
 ① 18 mm Diameter, 50-mm-Designs
 ② 18 mm Diameter, 100-mm-Designs
 ③ 30 mm Diameter, 150-mm-Designs
 ④ 30 mm Diameter, 280-mm-Design

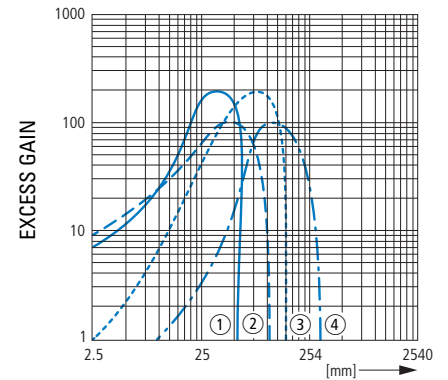

Dimensions

E58-Serie

E58-18...

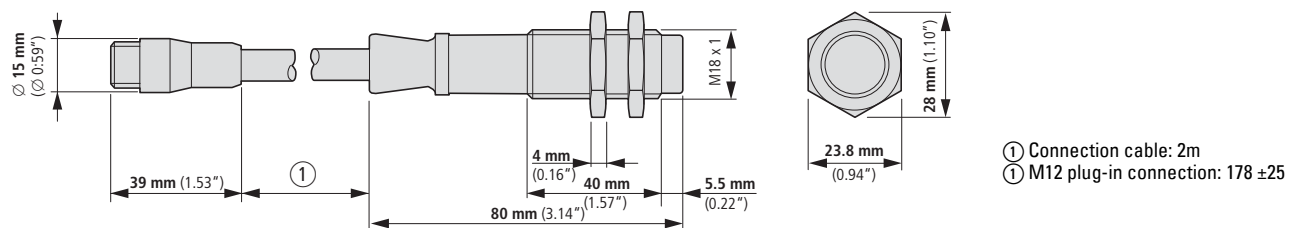

E58-30...

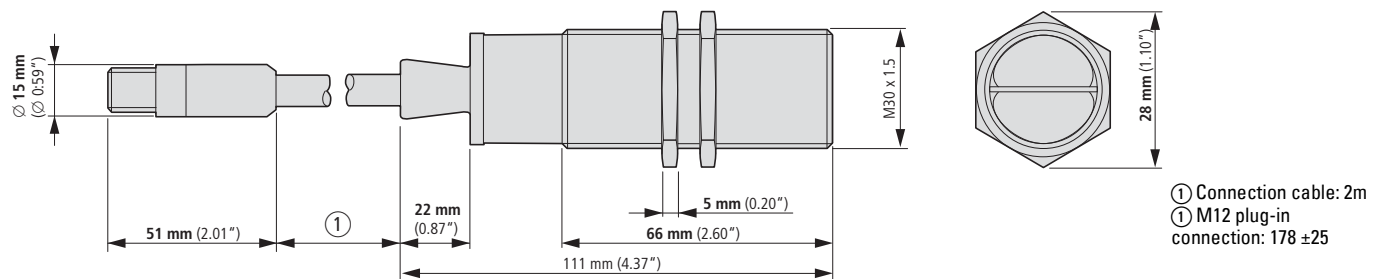

Technical data

		2-wire		4-wire	
		E58-18...	E58-30...	E58-18...	E58-30...DP150
General					
Standards		IEC/EN 60947-5-2			
Ambient temperature	°C	- 40 - + 70	- 25 - + 55	- 40 - + 55	- 40 - + 55
Protection type		IP69K	IP69K	IP69K	IP69K
Mechanical shock resistance	g	100 Shock duration 3 ms			
Characteristics					
Rated operational voltage	U _e	18 - 50 V DC	18 - 50 V DC	10 - 30 V DC	10 - 30 V DC
Operating current in the switched state at 24 V DC	I _b	1.7 mA	1.7	-	-
Maximum load current	I _e	100	300	PNP: 100 NPN: 250	100
Response time	ms	35	35	1	1.6
Switching state display	LED	Red	Red	Red	Red
Protective functions		Short-circuit protective device			
Connection					
Design (outer dimensions)	mm	M18 x 1	M30 x 1.5	M18 x 1	M30 x 1.5
Material		Stainless steel	Stainless steel	Stainless steel	Stainless steel

Notes

Further technical data can be found in the Online Catalog at <http://de.ecat.moeller.net>

Description



- ① 18 mm thread
- ② Voltage LED (green)
- ③ Output LED (red)
- ④ Targetlock™ LED (orange)
- ⑤ Gain adjustment

Short Description

Eaton's SM series photoelectric sensors offer a high performance and simple use in a compact, cost-effective design. Regardless how good a sensor's performance just a slight maladjustment or incorrectly positioned target will sooner or later impact reliability. TargetLock™ not only simplifies sensor setup but visually confirms your sensor is positioned to operate with the highest possible reliability. In addition TargetLock™ outputs diagnostic information during operation, which provide an early warning about potential problems to help prevent costly downtimes. The SM Series includes many other features that simplify use. Visible sensing beams on all models show you exactly where the sensors are pointing. The durable enclosure features multiple fixing possibilities to easily fit on your equipment in the tightest of spaces. Full protection from overvoltage, reverse polarity and short circuits reduces the chance of damage. Bright 360° LED indicators clearly show sensor status.







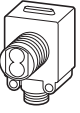

Product Features

- Bright indicators for current, output, and TargetLock™.
- TargetLock™ simplifies setup and ensures a high operational reliability.
- Perfect Prox® models detect targets with different colors at the same range while ignoring background objects.
- DC-models feature PNP and NPN outputs.
- Visible sensing beam on all models lets you see where the beam is aimed for quick flush mounting and alignment.
- Compact design for space-saving flush mounting.
- Range of mounting options, including standard 18 mm thread.
- Short-circuit, overload and protection against polarity reversal.
- Full family includes thru-beam, polarized reflex, diffuse reflective and Perfect Prox® background rejection.

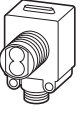
Approvals



Ordering

Rated operational voltage U_e	Description	Rated switching distance S_n mm	Switching type	Switching principle	For connection of:	Part no. Article no.	Price see price list	Std. pack	
E65-SM									
4-wire Insulated material									
Reflected-light beam									
	10 - 30 V DC	with background suppression (Perfect Prox)	50	NPN PNP	Dark switching	2 m connection cable	E65-SMPP050-HD 135702	1 off  	
						Plug-in connection M12 x 1	E65-SMPP050-HDD 135703		
					Light switching	2 m connection cable	E65-SMPP050-HL 135704		
				Plug-in connection M12 x 1	E65-SMPP050-HLD 135705				
			100	NPN PNP	Dark switching	2 m connection cable	E65-SMPP100-HD 135710		
						Plug-in connection M12 x 1	E65-SMPP100-HDD 135711		
	Light switching	2 m connection cable			E65-SMPP100-HL 135712				
		Plug-in connection M12 x 1	E65-SMPP100-HLD 135713						
	-	200	NPN PNP	Dark switching	2 m connection cable	E65-SMSD200-HD 135726			
					Plug-in connection M12 x 1	E65-SMSD200-HDD 135727			
				Light switching	2 m connection cable	E65-SMSD200-HL 135728			
					Plug-in connection M12 x 1	E65-SMSD200-HLD 135729			
Reflex photoelectric sensor									
	10 - 30 V DC	Polarized light for combination with reflector	3000	NPN PNP	Dark switching	2 m connection cable	E65-SMPR3-HD 135718	1 off  	
						Plug-in connection M12 x 1	E65-SMPR3-HDD 135719		
					Light switching	2 m connection cable	E65-SMPR3-HL 135720		
						Plug-in connection M12 x 1	E65-SMPR3-HLD 135721		
Thru-beam photoelectric sensor									
	10 - 30 V DC	Detector (for combination with source)	15000	NPN PNP	Dark switching	2 m connection cable	E65-SMTD15-HD 135730	1 off  	
						Plug-in connection M12 x 1	E65-SMTD15-HDD 135731		
					Light switching	2 m connection cable	E65-SMTD15-HL 135732		
						Plug-in connection M12 x 1	E65-SMTD15-HLD 135733		
		-	15000	NPN PNP	-	Dark switching	2 m connection cable		E65-SMTS15-HA 135734
							Plug-in connection M12 x 1		E65-SMTS15-HAD 135735
						Light switching	2 m connection cable		E65-SMTS15-HL 135732
							Plug-in connection M12 x 1		E65-SMTS15-HLD 135733

Information relevant for export to North America



Product Standards
UL File No.
UL CCN
CSA File No.
CSA Class No.
NA Certification
Max. Voltage Rating
Degree of Protection

UL 508; CSA-C22.2 No. 14; IEC60947-5-2; CE marking
E166051
NRKH, NRKH7
UL report applies to both Canada and US
-
UL listed, certified by UL for use in Canada
132 V AC, 30 V DC
IEC: IP68, IP69K; UL/CSA Type: 1, 3, 4, 4x, 6, 6P, 12, 13

Technical data

				E65...50-H...	E65...15-H...	E65...-HA...
General						
Standards				IEC/EN 60947-5-2		
Ambient temperature				-	-	-
Operation	θ	°C		-25 - +55	-25 - +55	-25 - +55
Storage	θ	°C		-25 - +70	-25 - +70	-25 - +70
Protection type				IP68, IP69K	IP68, IP69K	IP68, IP69K
Mechanical shock resistance		g		50 Shock duration 10 ms		
Characteristics						
Rated operational voltage		U _e		10 - 30 V DC	10 - 30 V DC	10 - 30 V DC
Operating current in the switched state at 24 V DC	I _b	mA		20	20	40
Maximum load current	I _e	mA		100	100	100
Switching Frequency		Hz		-	-	-
Switching state display		LED		Red	Red	Red
Operating voltage display		LED		Green	Green	Green
Boundary gain				Yellow	Yellow	Yellow
Protective functions				Short-circuit protective device Protection against polarity reversal Protection against wire breakage		
Connection				4-wire	4-wire	4-wire
Design (outer dimensions)		mm		33 x 41 x 37	33 x 41 x 37	33 x 41 x 37
Material				Insulated material	Insulated material	Insulated material
Notes				Further technical data can be found in the Online Catalog at http://de.ecat.moeller.net		

Engineering

Circuit diagrams

E65...HA



E65...HAD

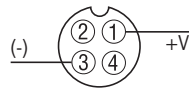

E65...HD
E65...HL

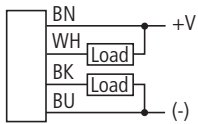

E65...HDD
E65...HLD

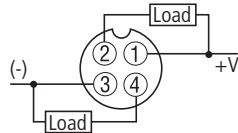

Excess gain chart

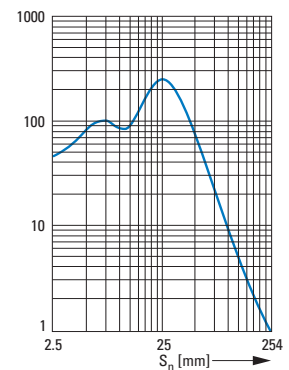
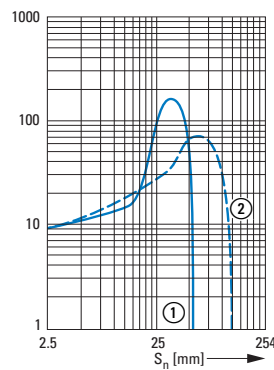
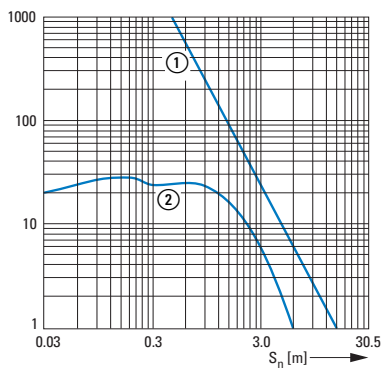

- ① One-way light barrier
- ② Retroreflective sensing sensor with polarization filter

- ① 50 mm Perfect Prox®
- ② 100 mm Perfect Prox®

- Light switch
- 90% reflection test card

Dimensions

E65-SM-Series

- E65...-HD
- E65...-HL
- E65...-HA

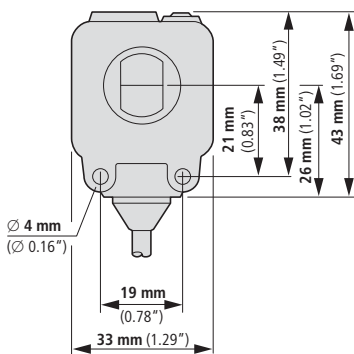

- E65...-HDD
- E65...-HLD
- E65...-HAD

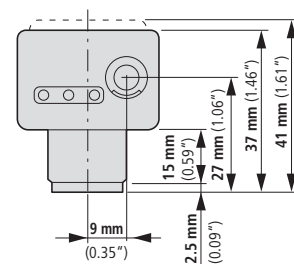
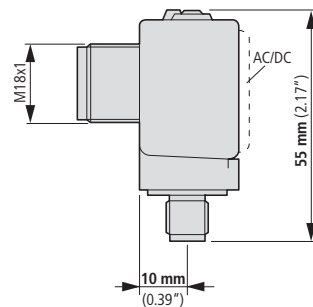

Description



Short Description

The E67 Long Range Perfect Prox series includes long-range sensors with background suppression, making it ideal for demanding sensing applications. E67 Long Range Perfect Prox sensors will reliably detect target objects within their sensing range regardless of variations in color, reflectance, contrast, or surface shape. Accordingly, they will simply ignore objects that are just outside their target range.

Product Features

- Perfect Prox technology provides exceptional background rejection and application problem solving
- Sensing ranges of 60 to 240 cm are available.
- No user adjustments required.
- Dual indicators communicate both output and power status from an easy-to-see location at the top of the sensor enclosure
- The DC sensors come with NPN and PNP outputs.
- Two mounting options for maximum flexibility
- Fully sealed enclosure.

Approvals

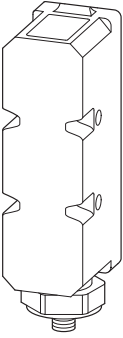

Ordering

Rated switching distance S_n mm	Switching type	Type of light	Light switching		Dark switching		Std. pack
			Part no. Article no.	Price see price list	Part no. Article no.	Price see price list	
E67 Long Range Series with background suppression (Perfect Prox) 4-wire Reflected-light beam Rated operational voltage U_e 18 – 30 V DC Plug-in connection M12 x 1							
	600	NPN PNP	Infra-red	E67-LRDP060-HLD 100540		E67-LRDP060-HDD 100539	1 off
	700			E67-LRDP070-HLD 100542		E67-LRDP070-HDD 100541	
	800			E67-LRDP080-HLD 100544		E67-LRDP080-HDD 100543	
	900			E67-LRDP090-HLD 100546		E67-LRDP090-HDD 100545	
	1000			E67-LRDP100-HLD 100548		E67-LRDP100-HDD 100547	
	1100			E67-LRDP110-HLD 100550		E67-LRDP110-HDD 100549	
	1200			E67-LRDP120-HLD 100552		E67-LRDP120-HDD 100551	
	1300			E67-LRDP130-HLD 100554		E67-LRDP130-HDD 100553	
	1400			E67-LRDP140-HLD 100556		E67-LRDP140-HDD 100555	
	1500			E67-LRDP150-HLD 100558		E67-LRDP150-HDD 100557	
	1600			E67-LRDP160-HLD 100560		E67-LRDP160-HDD 100559	
	1700			E67-LRDP170-HLD 100562		E67-LRDP170-HDD 100561	
	1800			E67-LRDP180-HLD 100564		E67-LRDP180-HDD 100563	
	1900			E67-LRDP190-HLD 100566		E67-LRDP190-HDD 100565	
	2000			E67-LRDP200-HLD 100568		E67-LRDP200-HDD 100567	
	2100			E67-LRDP210-HLD 100570		E67-LRDP210-HDD 100569	
	2200			E67-LRDP220-HLD 100572		E67-LRDP220-HDD 100571	
	2300			E67-LRDP230-HLD 100574		E67-LRDP230-HDD 100573	
	2400			E67-LRDP240-HLD 100576		E67-LRDP240-HDD 100575	

Dimensions

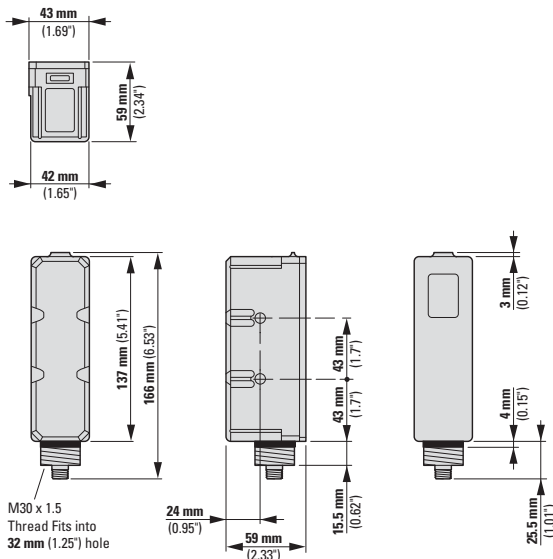

Engineering

Excess gain chart

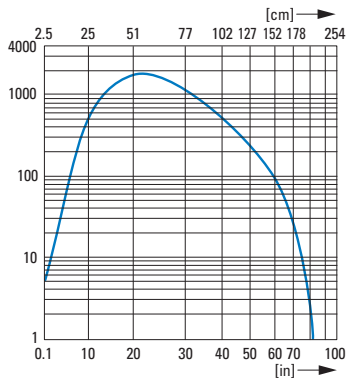

① This fixed sensing range is printed on the product label. Other ranges are available from Eaton upon request.

Circuit diagram

Connector Version - Face view male

DC current¹⁾

NPN & PNP

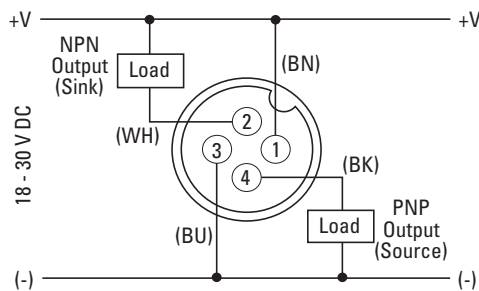

→ DIN IEC 304, DIN IEC 757

BK	Black
BN	Brown
BU	Blue
GN	Green
RD	Red
WH	white

¹⁾ Connector Versions: The pin numbering and wire colors are typical of several manufacturers, however, variations are possible.

→ In case of discrepancies, rely on function indicated and pin location rather than pin number or wire color.

Technical data

			E67
General			
Ambient temperature		°C	
Operation	θ	°C	-35 - + 55
Storage	θ	°C	-40 - +70
Protection type			IP67
Mechanical shock resistance		g	30 Shock duration 6 ms
Vibration			10 g (10 Hz - 2 kHz)
Characteristics			
Rated operational voltage		U_e	18 – 30 V DC
Maximum load current		I_e	< 100
Response time		ms	15
Switching state display		LED	Red
Operating voltage display		LED	Green
Connection			4-wire
Design (outer dimensions)		mm	Rectangular (166 x 59 x 43)
For connection of:			Plug-in connection M12 x 1

Description



Short Description

The NanoView™ Series from Eaton is a family of miniature rectangular photoelectric sensors designed for optimum value and sensing performance in a wide range of applications.

These small sensors are available for a wide variety of optical operating modes: retroreflective sensing sensor, diffuse reflective sensor, and thru-beam photoelectric sensor. They can even be used to detect transparent objects, such as plastic bottles, molded parts, containers, and films. NanoView sensors are housed in ABS enclosures rated IP66 or better. Two top-mounted indicator LEDs communicate power and output status.

Each model includes both light operate and dark operate modes. Termination options include a 4pole M8 connector cable or a built-in 6 ft (2m) cable. NanoView is the ultimate solution to sensing challenges that require reduced dimensions and costs.



Product Features

- Complete range.
- Small size: With a length of less than 38 mm and a depth of 13 mm, NanoView sensors can fit pretty much anywhere.
- Models with focused beam path: A focal length of 100 mm makes them perfect for detecting small target objects. In addition, a visible red LED beam makes them easy to set up.

Approvals

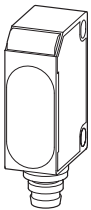

Ordering

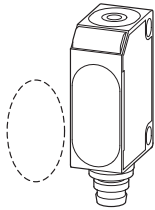
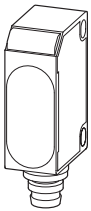
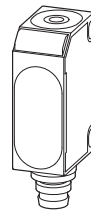
	Description	Rated operational voltage U_e	Switching principle	Rated switching distance S_n mm	Switching type	For connection of:	Type of light	Part no. Article no.	Price see price list	Std. pack
E71-Serie NanoView 4-wire										
	Source (for combination with detector)	10 - 30 V DC	Light/dark switching adjustable	1500	9999999	Plug-in connection M8 x 1	Infra-red	E71-NTBS-M8¹⁾ 100522	1 off 	
					9999999	2 m connection cable		E71-NTBS-CA¹⁾ 100521		
				6000	9999999	Plug-in connection M8 x 1		E71-TBS-M8¹⁾ 100536		
					9999999	2 m connection cable		E71-TBS-CA¹⁾ 100535		
	Detector (for combination with source)	10 - 30 V DC	Light/dark switching adjustable	6000	NPN	Plug-in connection M8 x 1	Infra-red	E71-TBRN-M8¹⁾ 100532		
					NPN	2 m connection cable		E71-TBRN-CA¹⁾ 100531		
					PNP	Plug-in connection M8 x 1		E71-TBRP-M8¹⁾ 100534		
					PNP	2 m connection cable		E71-TBRP-CA¹⁾ 100533		
	for combination with reflector Detecting transparent objects	10 - 30 V DC	Light/dark switching adjustable	800	NPN	Plug-in connection M8 x 1	Visible red	E71-CON-M8²⁾ 100426		
					NPN	2 m connection cable		E71-CON-CA²⁾ 100069		
				2500	PNP	Plug-in connection M8 x 1		E71-COP-M8²⁾ 100428		
					PNP	2 m connection cable		E71-COP-CA²⁾ 100427		
	for combination with reflector (polarized light)	10 - 30 V DC	Light/dark switching adjustable	2500	PNP	Plug-in connection M8 x 1	Visible red	E71-PRP-M8²⁾ 100526		
					PNP	2 m connection cable		E71-PRP-CA²⁾ 100525		
				NPN	Plug-in connection M8 x 1	E71-PRN-M8²⁾ 100524				
					2 m connection cable	E71-PRN-CA²⁾ 100523				
	Beam: focused, forward viewing	10 - 30 V DC	Light/dark switching adjustable	100	NPN	Plug-in connection M8 x 1	Visible red	E71-FFDN-M8¹⁾ 100511		
					NPN	2 m connection cable		E71-FFDN-CA¹⁾ 100429		
				PNP	2 m connection cable	E71-FFDP-CA¹⁾ 100517				
					PNP	Plug-in connection M8 x 1		E71-FFDP-M8¹⁾ 100518		
	Beam: straight	10 - 30 V DC	Light/dark switching adjustable	350	NPN	Plug-in connection M8 x 1	Infra-red	E71-SDN-M8²⁾ 100528		
					NPN	2 m connection cable		E71-SDN-CA²⁾ 100527		
				PNP	Plug-in connection M8 x 1	E71-SDP-M8²⁾ 100530				
					2 m connection cable	E71-SDP-CA²⁾ 100529				

Information relevant for export to North America



- Product Standards
UL File No.
UL CCN
CSA File No.
NA Certification
Max. Voltage Rating
Degree of Protection

UL 508; CSA-C22.2 No. 14; IEC60947-5-2; CE marking
E166051
NRKH, NRKH7
UL report applies to both Canada and US
UL listed, certified by UL for use in Canada
30 V DC
IEC: IP67; UL/CSA Type: -

- Product Standards
UL File No.
UL CCN
CSA File No.
NA Certification
Max. Voltage Rating
Degree of Protection

UL 508; CSA-C22.2 No. 14; IEC60947-5-2; CE marking
E166051
NRKH, NRKH7
UL report applies to both Canada and US
UL listed, certified by UL for use in Canada
30 V DC
IEC: IP66; UL/CSA Type: -

Engineering

Charts

E71-P

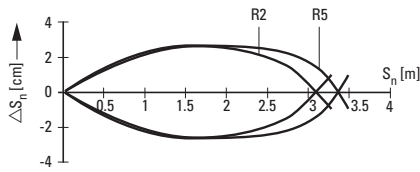

R2 = 48-mm reflector, R5 = 75-mm reflector

E71-F

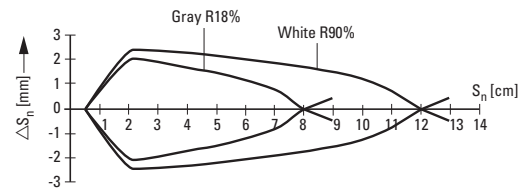

E71-S

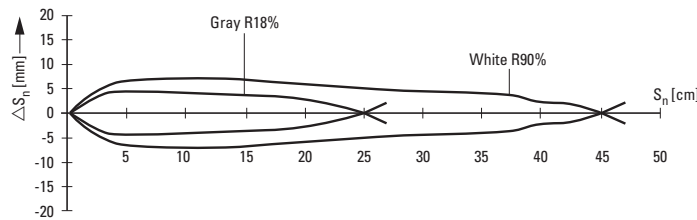

E71-C

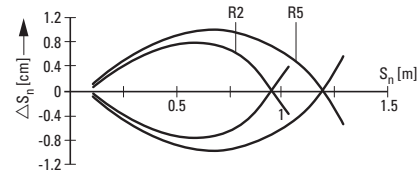

R2 = 48-mm reflector, R5 = 75-mm reflector

Circuit diagrams

NPN

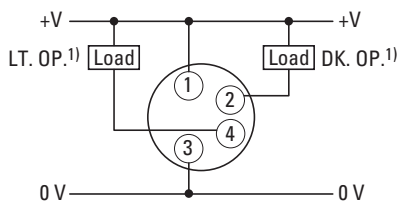

PNP

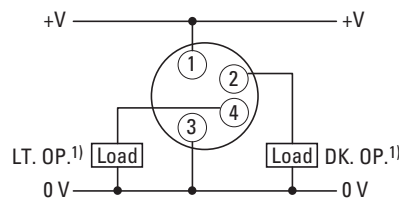

→ DIN IEC 304, DIN IEC 757

BK	Black
BN	Brown
BU	Blue
WH	white

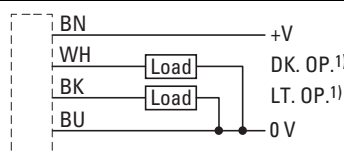
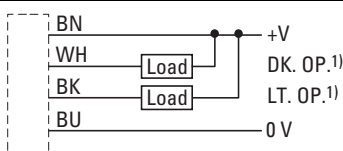

¹⁾ LT. OP. = Light operated
DK. OP. = dark operated

Dimensions

E71...

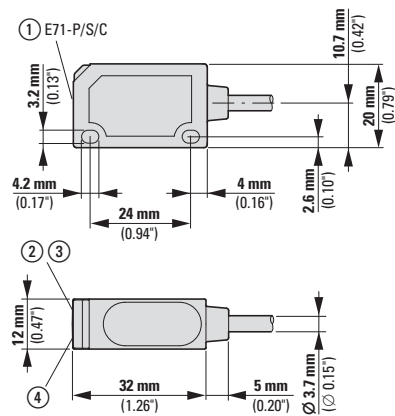

- ① Sensitivity potentiometer
- ② Stability LED
- ③ Power On LED
- ④ Output LED

Technical data

	E71-T...	E71-N...	E71-P...	E71-S...	E71-F...	E71-C...
General						
Ambient temperature	°C					
Operation	θ	°C	-25 - +55	-25 - +55	-25 - +55	-25 - +55
Storage	θ	°C	-25 - +70	-25 - +70	-25 - +70	-25 - +70
Protection type		IP67	IP67	IP66	IP66	IP67
Mechanical shock resistance	g	30 Shock duration 11 ms	30 Shock duration 11 ms	30 Shock duration 11 ms	30 Shock duration 11 ms	30 Shock duration 11 ms
Vibration		Amplitude 0.5 mm: 10 - 55 Hz. IEC/EN 60068-2-6	Amplitude 0.5 mm: 10 - 55 Hz. IEC/EN 60068-2-6	Amplitude 0.5 mm: 10 - 55 Hz. IEC/EN 60068-2-6	Amplitude 0.5 mm: 10 - 55 Hz. IEC/EN 60068-2-6	Amplitude 0.5 mm: 10 - 55 Hz. IEC/EN 60068-2-6
Characteristics						
Bemessungsschaltabstand	S_n	mm	6000	1500	2500	350
Rated operational voltage		U_e	10 - 30 V DC	10 - 30 V DC	10 - 30 V DC	10 - 30 V DC
Maximum load current		I_e	mA	< 100	< 100	< 100
Switching Frequency		Hz	500	500	500	500
Response time		ms	1	1	1	1
Switching state display		LED	Yellow	Yellow	Yellow	Yellow
Operating voltage display		LED	Green	Green	Green	Green
Protective functions			Short-circuit protective device Protection against polarity reversal	Short-circuit protective device Protection against polarity reversal	Short-circuit protective device Protection against polarity reversal	Short-circuit protective device Protection against polarity reversal
Connection			4-wire	4-wire	4-wire	4-wire
Bauform (äußere Abmessungen)		mm	Rectangular (20 x 12 x 32)	Rectangular (20 x 12 x 32)	Rectangular (20 x 12 x 32)	Rectangular (20 x 12 x 32)
For connection of:						
...CA			2 m connection cable	2 m connection cable	2 m connection cable	2 m connection cable
...M8...			Plug-in connection M8 x 1	Plug-in connection M8 x 1	Plug-in connection M8 x 1	Plug-in connection M8 x 1
Material			Insulated material	Insulated material	Insulated material	Insulated material

Description



Short Description

The IntelliView™ Series from Eaton is a family of compact, high performance specialty photoelectric sensors designed to solve a wide array of sensing challenges.

IntelliView encompasses a variety of new sensing technologies: color, contrast and luminescence sensing; field-adjustable foreground and background suppression sensing; short-range distance sensing with analog outputs; and long-range, high-precision laser distance sensing with analog outputs.

To fit into your application, IntelliView sensors are available in industry-standard M18 flat-tubular and compact rectangular enclosure sizes. For ease of installation and replacement, all models are available with micro-connectors.

Product Features

- **New Sensing Technologies**—Eaton has developed high-accuracy sensing solutions designed to detect color, contrast, luminescence, and distance.
- **Small Size, Big Solutions**—IntelliView sensors come in either compact rectangular or flat-tubular enclosure sizes, both rugged sealed enclosures
- **Simple "learning mode" installation:** Most models feature a learning mode for quick and simple installation and setup.
- **Adjustable Background Suppression**—For the first time, Eaton offers a fully field-adjustable background suppression photoelectric sensor capable of detecting targets as far as 3.9 ft (1.9m) away.
- **LED Indicators and Pushbuttons**—Multiple LEDs communicate output and power status while built-in pushbuttons and adjustment potentiometers simplify the teaching of sensor settings.

Approvals



Adjustable Foreground/ Background Suppression Models



- Ignores nuisance foreground or background objects.
- Field-adjustable sensing ranges.
- Compact 50x50 mm rectangular enclosure size.
- M12 micro-connector termination with 90- and 180-degree rotation options.
- Sensing ranges up to 47.2 in (120 cm).

Foreground/Background Sensing Basic Information

Foreground/background suppression sensors make it possible to set exact minimum and maximum detection distances. In other words, they can be used to ensure that targets will only be detected if they are exactly within the specified range. This prevents false positives caused by objects that are too close (foreground) or too far (background). This type of sensor is ideal for suppressing the detection of box edges and bottoms, sending an output only upon the presence of goods actually contained in the box.

Distance Sensing Models with Analog Outputs



Long-Range, High-Precision Laser
Distance Measurement Sensor



Short-Range Distance Sensor

- When within the effective range of the sensor, outputs a 0–10V signal proportional to the target's distance from the sensor face
- Class II laser emitter detects objects from 0.3 to 4m (1 to 13.1 ft) away.
- Two additional PNP outputs can be programmed to switch at predetermined ranges.
- Simple three-step learning mode for programming range limits.
- Unmatched accuracy and resolution at long sensing distances.
- Visible red LED emitter detects objects from 5 to 10 cm (1.9 to 3.9 in).
- Two indicator LEDs communicate sensor status: a yellow LED with light intensity proportional to the target's distance within the sensor's range, and a red LED that activates when the target is beyond maximum sensing range.
- Flat tubular enclosure can be mounted using the body threads or flat against a surface

Distance Sensing Explained

Distance sensors output a 0–10V analog signal in proportion to the measurement of the distance between the sensor and target. Optical triangulation, a technology similar to that used in Eaton's Perfect Prox or diffuse sensors, is used for short- to mid-range distance sensing applications that do not require a high degree of accuracy. For distance sensing applications that involve longer ranges, time-of-flight technology is used instead. "Time-of-flight" is a method that measures the time it takes for the emitted beam to bounce off the target and return to the sensor. Time-of-flight is highly accurate, with precise resolution over long sensing distances.

Color Sensors



- Can be programmed to recognize three different colors independently.
- Capable of sensing targets 5–45 mm away from the sensor face.
- Rectangular plastic enclosure features a four-digit display, two programming buttons and output status LEDs.
- Optional serial connection (RS485) allows for remote communications.
- Standard 8pole M12 micro connector.

Color Sensing Basic Information

Color sensors work by using a chromaticity detection algorithm. Chromaticity is determined by two characteristics: hue and saturation. Hue is determined by the reflected light's wavelength, while saturation indicates the pureness percentage (with white representing 0%). Eaton's color sensor goes one step further and provides an optional "chromaticity plus intensity" algorithm. This operating mode provides a higher sensitivity to tone variations and is recommended for detection of different colors on the same type of material. It will also better distinguish between gray tones.

The color of a target is determined by the color components of the reflected source light. The target color is identified by analyzing the red (R), green (G) and blue (B) channels of reflected light.

For example, yellow can be identified by the following reflections:

R=50%, G=50%, B=0%

orange can be identified by

R=75%, G=25%, B=0%

pink by

R=50%, G=0%, B=0%

The RGB combinations are practically unlimited. Applications for color sensors are common in many industries, ranging from quality and process control, to automatic material handling for identification, to orientation and selection of objects according to their color.

Contrast Sensors



- Ideal for detecting different colored or grayscale contrasts, such as registration marks
- Capable of sensing targets out to 10 mm from the sensor face
- Simple three-step setup routine for quick installation or optional "fine setup routine" for more complicated applications
- Complementary outputs can function in either light operate or dark operate modes.
- Standard M12 4pole micro-connector.

Contrast Sensing Basic Information

Contrast sensors (also defined as color mark readers, according to their most popular application) go beyond simple presence/absence detection to distinguish two surfaces according to the contrast produced by their difference in reflectivity.

For example, a dark reference mark (low reflectivity) can be detected by comparing it against the contrast of the lighter surface (high reflectivity). A white LED light source is used for general-purpose contrast detection. This makes it possible to detect the slightest contrast changes even when the reference material has the same composition and color.

Contrast sensors are frequently used in automated packaging applications for registration mark detection to automate the folding, cutting and sorting phases.

Luminescence Sensor



- Perfect for the detection of any luminescent target, even on reflective materials such as ceramics, metal or mirrored glass.
- Capable of sensing from 8–20 mm from the sensor face.
- Simple three-step setup routine. An advanced setup routine is also available for more complex applications.
- Can function in either light operate or dark operate mode.
- Standard M12 4pole micro-connector.







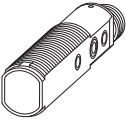

Luminescence Sensing Basic Information

Luminescence is defined as visible light emission from fluorescent or phosphorescent substances.

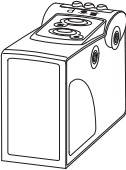
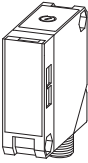
Luminescence sensors emit ultraviolet light, which is then reflected at a higher wavelength from the target surface. The UV emission from the sensor is modulated and the visible light received is synchronized, resulting in immunity against external interferences such as reflections caused by shiny objects.

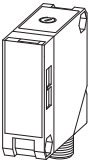
Luminescence sensors are used in various industries to detect labels, fluorescent marks or signs, fluorescent glues on paper, to distinguish cutting and sewing guides, and to check fluorescent paints or lubricants.

Ordering

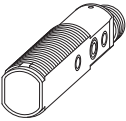
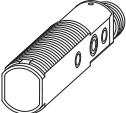
	Conne- ction	Rated operational voltage U_e	Switching principle	Rated switching distance S_n mm	Switch- ing type	Type of light	Part no. Article no.	Price see price list	Std. pack
E75-Serie IntelliView Reflected-light beam Plug-in connection M12 x 1									
Distance sensor 5 - 10 cm Analog output 0 - 10 V 	4-wire	18 - 30 V DC	analog (0 - 10 V)	100	Analog	Infra- red	E75-DST010A010-M12 166995		1 off  
Distance sensor 30 - 400 cm 2 programmable PNP outputs 1 analog output 0 - 10 V 	5 conduct or	15 - 30 V DC	analog (0 - 10 V) Light switching	4000	PNP	Visible red	E75-DST400A010-M12 166996		
Background suppression (Perfect Prox) 	4-wire	10 - 30 V DC	Light/dark switching adjustable	100	PNP	Visible red	E75-PPA010P-M12 166998		
				250		Infra- red	E75-PPA025P-M12 166999		
				500		Infra- red	E75-PPA050P-M12 166924		
Background suppression (Perfect Prox) 	4-wire	10 - 30 V DC	Light/dark switching adjustable	1200	PNP	Infra- red	E75-PP1MP-M12 166997		
Fore-/background suppression (Perfect Prox) 	4-wire	10 - 30 V DC	Light/dark switching adjustable	1100	PNP	Infra- red	E75-PPA110P-M12 166925		
E76-Serie IntelliView Reflected-light beam Plug-in connection M12 x 1									
Color sensing 	3 NO NPN outputs 3 NO PNP outputs 3 NO NPN outputs RS485-connection possible → Engineering	8 conduct or	10 - 30 V DC	-	450	NPN	Infra- red	E76-CLRMKN-M12 166926	1 off  
						PNP		E76-CLRMKP-M12 166927	
						NPN		E76-CLRMKRS-M12 166928	
Contrast sensing 	4-wire	10 - 30 V DC	Light/dark switching adjustable	100	NPN	Infra- red	E76-CNT010N-M12 166929		
				100	PNP		E76-CNT010P-M12 166892		
Luminescence sensing 	4-wire	10 - 30 V DC	Light/dark switching adjustable	200	PNP	UV (white LED, 400 - 700 nm)	E76-UV020P-M12 166830		

Engineering

Detection diagram E75-DST400A010-M12

Analog output

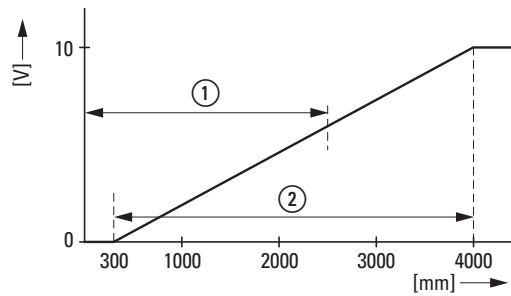

- ① Measuring distance
- ② Measurement range

Digital output

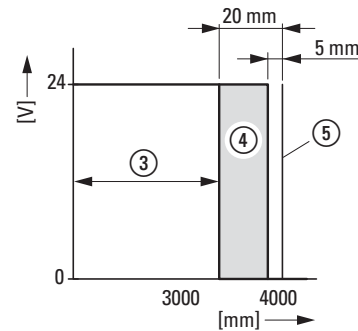

- ③ Switching distance
- ④ Hysteresis
- ⑤ Background

Black / white difference

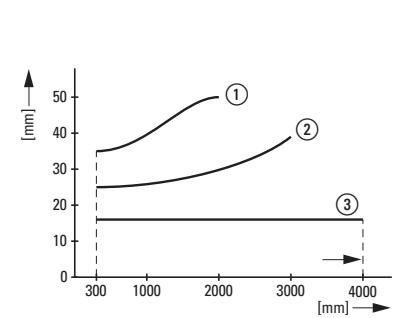

- ① White = 90 %, Black = 4 %
- ② White = 90 %, Grey = 18 %
- ③ White = 90 %

Detection diagram E75-DST010A010-M12

Analog output, proportional (default setting)

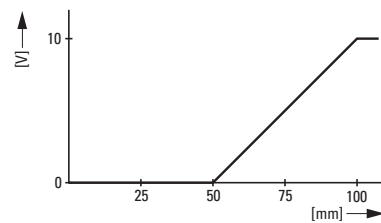

Analog output, proportionally inverted

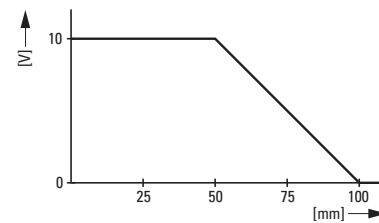

Detection diagram E76-CLR...

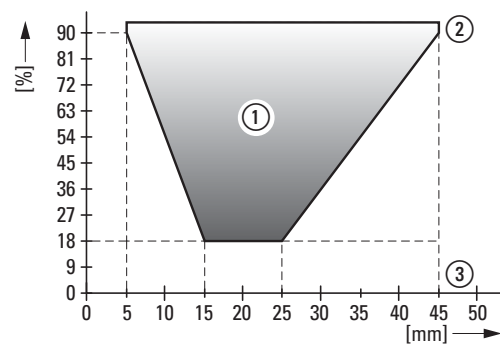

- ① Detectable Colors
- ② White/Light yellow
- ③ Dark blue/Black

Detection diagram E76-CN...

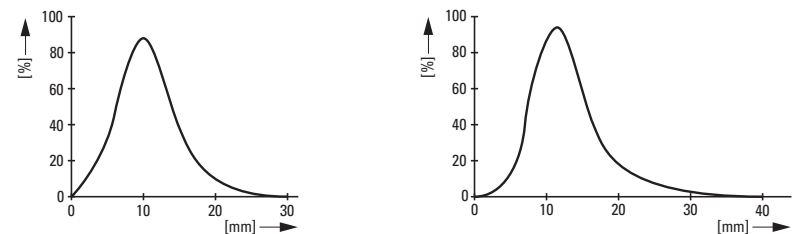

Circuit diagram E75-PPA.../E76PP1...

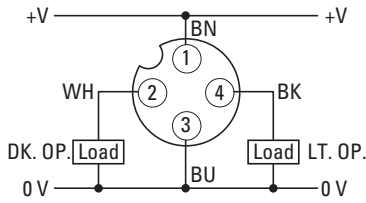

→ DIN IEC 304, DIN IEC 757

BN	Brown
BU	Blue
GN	Green
GY	Gray
PK	Pink
RD	Red
WH	white
YE	Yellow

Circuit diagram E75-DST010A010-M12

"Directly proportional" (DIR) is enabled when the white wire is connected to +V. "Indirectly proportional" is enabled when the white wire is connected to 0V. The white wire must be connected!

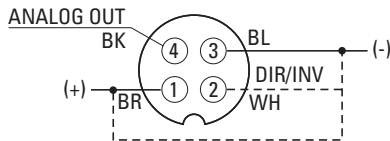

Circuit diagram E75-DST400A010-M12

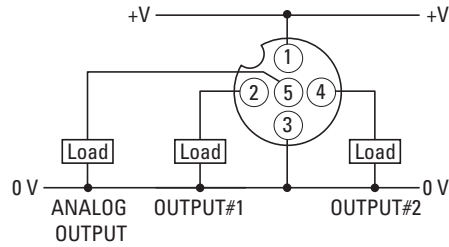

Circuit diagrams E76-CLR...

NPN

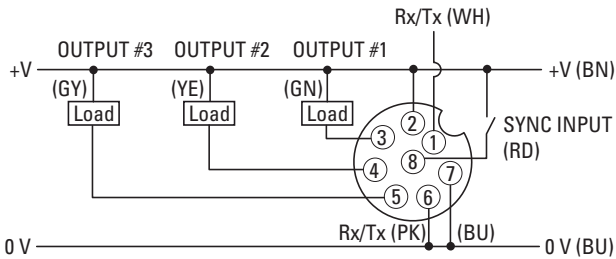

PNP

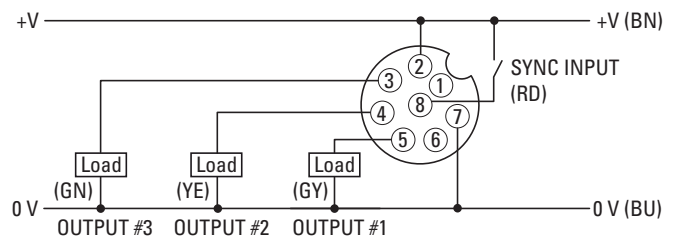

RS485

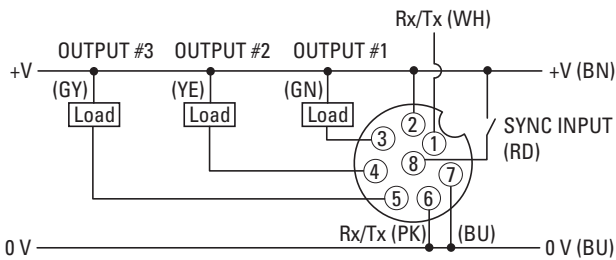

Circuit diagrams E76-CN...

NPN

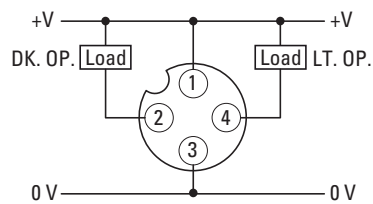

PNP

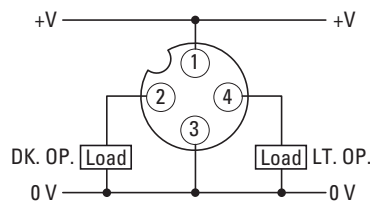

Circuit diagram E76-UV

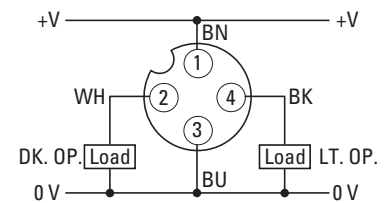

Technical data

			E76-CLR...	E76-CNT...	E76-UV...
General					
Standards			IEC/EN 60947-5-2	IEC/EN 60947-5-2	IEC/EN 60947-5-2
Ambient temperature		°C			
Operation	θ	°C	-10 - +55	-10 - +55	-10 - +55
Storage	θ	°C	-20 - +70	-20 - +70	-10 - +70
Protection type			IP67	IP67	IP67
Mechanical shock resistance		g	30 Shock duration 11 ms	30 Shock duration 11 ms	30 Shock duration 11 ms
Vibration			Amplitude 0.5 mm: 10 - 55 Hz. IEC/EN 60068-2-6	Amplitude 0.5 mm: 10 - 55 Hz. IEC/EN 60068-2-6	Amplitude 0.5 mm: 10 - 55 Hz. IEC/EN 60068-2-6
Characteristics					
Rated switching distance	S_n	mm	450	100	200
Rated operational voltage		U_e	10 - 30 V DC	10 - 30 V DC	10 - 30 V DC
Maximum load current	I_e	mA	-	< 100	< 100
Switching Frequency		Hz	770	2700	445
Response time		ms	0.65	0.19	1.1
Switching state display		LED	Yellow	Yellow	Yellow
Operating voltage display		LED	-	Green	Green
Protective functions			Short-circuit protective device	Short-circuit protective device	Short-circuit protective device
Connection			8 conductor	4-wire	4-wire
Design (outer dimensions)		mm	Rectangular (50 x 50 x 25)	M18 x 1	M18 x 1
For connection of:			Plug-in connection M12 x 1	Plug-in connection M12 x 1	Plug-in connection M12 x 1

			E75-DST0...	E75-DST4...	E75-PP1...	E75-PPA...
General						
Standards			IEC/EN 60947-5-2	IEC/EN 60947-5-2	IEC/EN 60947-5-2	IEC/EN 60947-5-2
Ambient temperature		°C				
Operation	θ	°C	-10 - +55	0 - +50	-25 - +55	-25 - +55
Storage	θ	°C	-20 - +70	-20 - +70	-25 - +70	-25 - +70
Protection type			IP67	IP67	IP67	IP65
Mechanical shock resistance		g	30 Shock duration 11 ms	30 Shock duration 11 ms	30 Shock duration 11 ms	30 Shock duration 11 ms
Vibration			Amplitude 0.5 mm: 10 - 55 Hz. IEC/EN 60068-2-6	Amplitude 0.5 mm: 10 - 55 Hz. IEC/EN 60068-2-6	Amplitude 0.5 mm: 10 - 55 Hz. IEC/EN 60068-2-6	Amplitude 0.5 mm: 10 - 55 Hz. IEC/EN 60068-2-6
Characteristics						
Rated switching distance	S_n	mm	100	4000	1200	
	... 010...		-	-	-	100
	... 025...		-	-	-	250
	... 050...		-	-	-	500
	... 110...		-	-	-	1100
Rated operational voltage		U_e	18 - 30 V DC	15 - 30 V DC	10 - 30 V DC	10 - 30 V DC
Maximum load current		I_e	mA	< 100	< 100	< 100
Switching Frequency		Hz	68	42	500	500
Response time		ms	7.3	12	-	-
Switching state display		LED	Yellow	Yellow	Yellow	Red
Operating voltage display		LED	Green	Green	Green	Green
Protective functions			-	Short-circuit protective device	Short-circuit protective device	Short-circuit protective device
Connection			4-wire	5 conductor	4-wire	4-wire
Design (outer dimensions)		mm	M18 x 1	Rectangular (80 x 53 x 31)	Rectangular (50 x 50 x 18)	Rectangular (50 x 50 x 18)
For connection of:			Plug-in connection M12 x 1	Plug-in connection M12 x 1	Plug-in connection M12 x 1	Plug-in connection M12 x 1

Dimensions

E75...

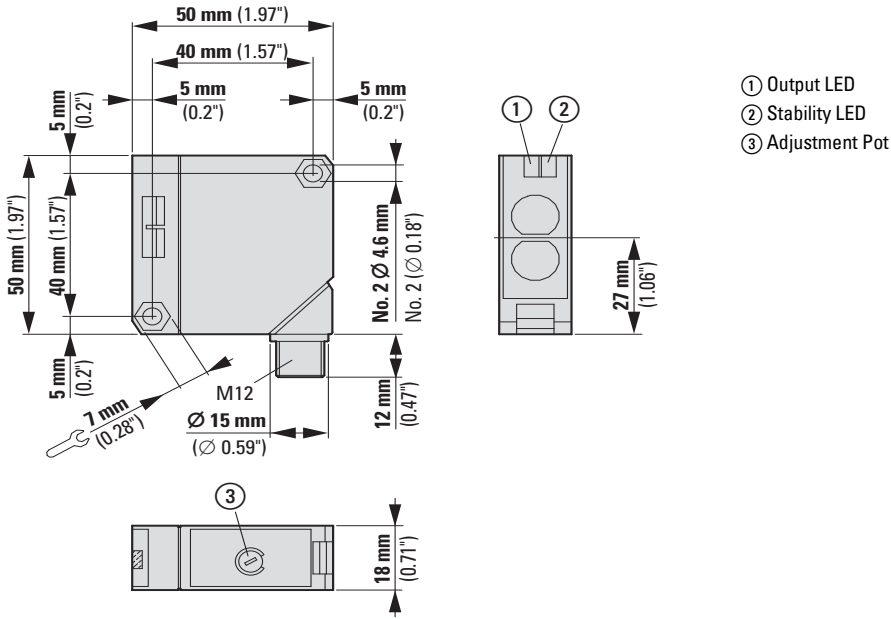

E76...

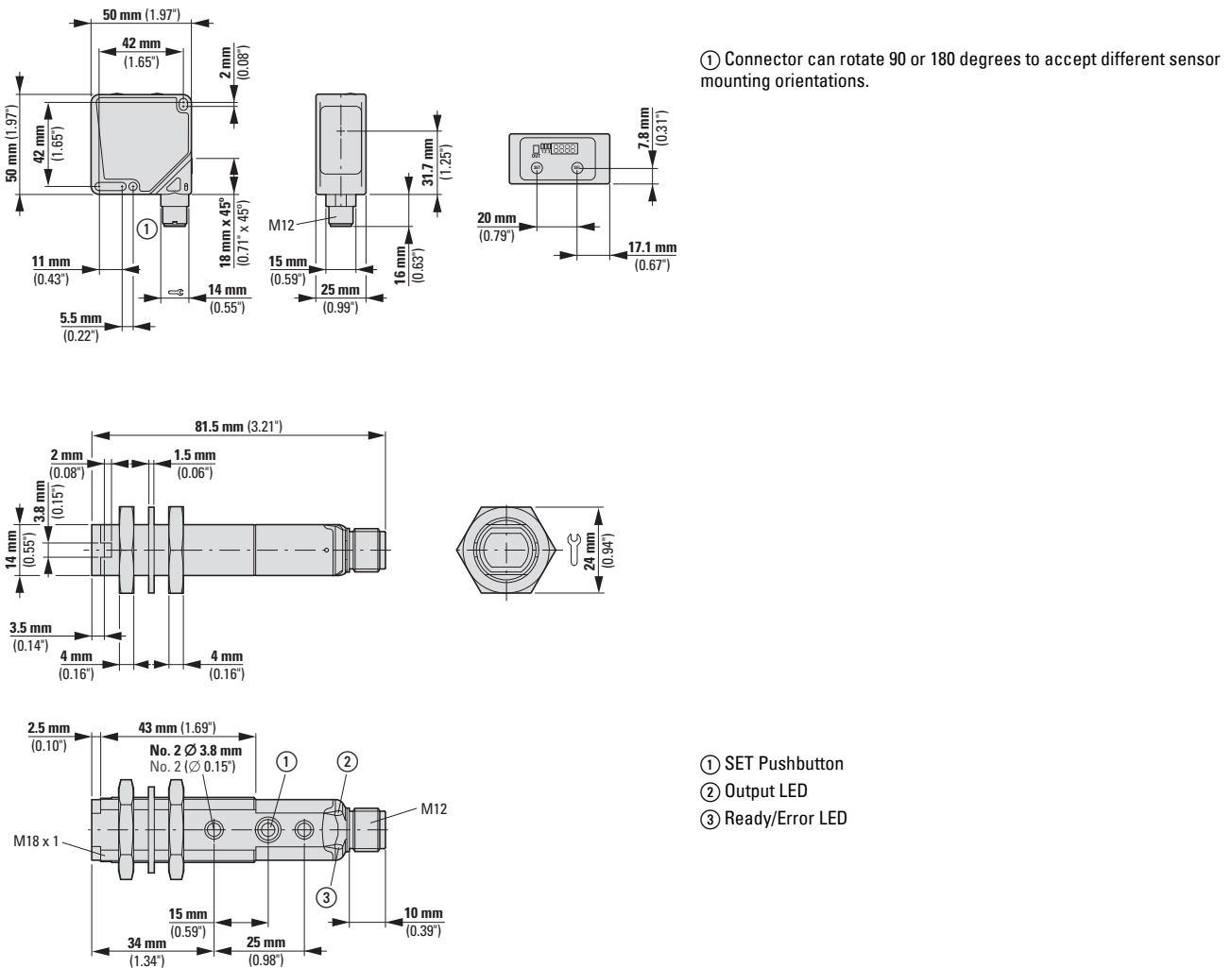

Description



- ① Models with cable or plug connectors available.
- ② All models feature an output signal indicator light.



- ① With mounting bracket.

Short Description

Capacitive Proximity Sensors from Eaton’s electrical business are self-contained devices designed to detect both metallic and nonmetallic targets. They are ideally suited for liquid level control and for sensing powdered or granulated material. For best operation, they should be used in an environment having relatively constant temperature and humidity.



Product Features



- Detect liquids, powders and other materials that are difficult or impossible with other sensor types.
- Corrosion-resistant insulated enclosure.
- Adjustable sensitivity.

Approvals



Ordering

	Rated operational voltage U_e	Rated switching distance S_n mm	Type of mounting	Switching type	For connection of:	Contact configuration N/O = normally open contact N/C = normally closed contact	Material	Part no. Article no.	Price see price list	Std. pack
E53										
2-wire										
M18 x 1										
	20 - 250 V AC	8	Flush	-	2 m connection cable	1 N/O	Insulated material	E53KAL18A2 134517		1 off
				-	Plug-in connection M12 x 1	1 N/O		E53KAL18A2SA 134760		
				-	2 m connection cable	1 NC		E53KBL18A2 134791		
				-	Plug-in connection M12 x 1	1 NC		E53KBL18A2SA 134794		
	15	Non-flush	-	2 m connection cable	1 N/O	E53KAL18A2E 134518				
			-	Plug-in connection M12 x 1	1 N/O	E53KAL18A2EA 134519				
			-	2 m connection cable	1 NC	E53KBL18A2E 134792				
			-	Plug-in connection M12 x 1	1 NC	E53KBL18A2EA 134793				
M30 x 1.5										
	20 - 250 V AC	20	Flush	-	2 m connection cable	1 N/O	Insulated material	E53KAL30A2 134769		1 off
				-	Plug-in connection M12 x 1	1 N/O		E53KAL30A2SA 134772		
				-	2 m connection cable	1 NC		E53KBL30A2 134803		
				-	Plug-in connection M12 x 1	1 NC		E53KBL30A2SA 134806		
	25	Non-flush	-	2 m connection cable	1 N/O	E53KAL30A2E 134770				
			-	Plug-in connection M12 x 1	1 N/O	E53KAL30A2EA 134771				
			-	2 m connection cable	1 NC	E53KBL30A2E 134804				
			-	Plug-in connection M12 x 1	1 NC	E53KBL30A2EA 134805				
3-wire										
M18 x 1										
	10 - 30 V DC	8	Flush	NPN	2 m connection cable	1 N/O	Insulated material	E53KAL18T110 134761		1 off
					Plug-in connection M12 x 1	1 N/O		E53KAL18T110SD 134764		
					2 m connection cable	1 NC		E53KBL18T110 134795		
					Plug-in connection M12 x 1	1 NC		E53KBL18T110SD 134798		
				PNP	2 m connection cable	1 N/O		E53KAL18T111 134765		
					Plug-in connection M12 x 1	1 N/O		E53KAL18T111SD 134768		
					2 m connection cable	1 NC		E53KBL18T111 134799		
					Plug-in connection M12 x 1	1 NC		E53KBL18T111SD 134802		

	Rated operational voltage U_e	Rated switching distance S_n mm	Type of mounting	Switching type	For connection of:	Contact configuration N/O = normally open contact N/C = normally closed contact	Material	Part no. Article no.	Price see price list	Std. pack								
3-wire																		
M18 x 1																		
	10 - 30 V DC	15	Non-flush	NPN	2 m connection cable	1 N/O	Insulated material	E53KAL18T110E 134762		1 off								
					Plug-in connection M12 x 1	1 N/O		E53KAL18T110ED 134763										
					2 m connection cable	1 NC		E53KBL18T110E 134796										
					Plug-in connection M12 x 1	1 NC		E53KBL18T110ED 134797										
					PNP	2 m connection cable		1 N/O			E53KAL18T111E 134766							
						Plug-in connection M12 x 1		1 N/O			E53KAL18T111ED 134767							
				2 m connection cable		1 NC		E53KBL18T111E 134800										
				Plug-in connection M12 x 1		1 NC		E53KBL18T111ED 134801										
				M30 x 1.5														
						10 - 30 V DC		20			Flush	NPN	2 m connection cable	1 N/O	Insulated material	E53KAL30T110 134773		1 off
					Plug-in connection M12 x 1								1 N/O	E53KAL30T110SD 134776				
					2 m connection cable								1 NC	E53KBL30T110 134807				
Plug-in connection M12 x 1	1 NC	E53KBL30T110SD 134810																
PNP	2 m connection cable	1 N/O	E53KAL30T111 134777															
	Plug-in connection M12 x 1	1 N/O	E53KAL30T111SD 134780															
	2 m connection cable	1 NC	E53KBL30T111 134811															
	Plug-in connection M12 x 1	1 NC	E53KBL30T111SD 134814															
	NPN	Non-flush	2 m connection cable		1 N/O		E53KAL30T110E 134774											
			Plug-in connection M12 x 1		1 N/O		E53KAL30T110ED 134775											
2 m connection cable			1 NC		E53KBL30T110E 134808													
Plug-in connection M12 x 1			1 NC		E53KBL30T110ED 134809													
PNP			2 m connection cable		1 N/O	E53KAL30T111E 134778												
			Plug-in connection M12 x 1		1 N/O	E53KAL30T111ED 134779												
	2 m connection cable	1 NC	E53KBL30T111E 134812															
	Plug-in connection M12 x 1	1 NC	E53KBL30T111ED 134813															
	10 - 30 V DC	25	Non-flush		NPN	2 m connection cable	1 N/O	Insulated material	E53KAL30T110E 134774		1 off							
						Plug-in connection M12 x 1	1 N/O		E53KAL30T110ED 134775									
2 m connection cable				1 NC		E53KBL30T110E 134808												
Plug-in connection M12 x 1				1 NC		E53KBL30T110ED 134809												
PNP				2 m connection cable		1 N/O	E53KAL30T111E 134778											
				Plug-in connection M12 x 1		1 N/O	E53KAL30T111ED 134779											
	2 m connection cable	1 NC	E53KBL30T111E 134812															
	Plug-in connection M12 x 1	1 NC	E53KBL30T111ED 134813															

Rated operational voltage U_e	Rated switching distance S_n mm	Type of mounting	Switching type	For connection of:	Contact configuration N/O = normally open contact N/C = normally closed contact	Material	Part no. Article no.	Price see price list	Std. pack
2-wire									
34 Ø									
	20 - 250 V AC	35	Non-flush	-	2 m connection cable	Insulated material	E53KAL34A2E 134781		1 off
				-	Plug-in connection M12 x 1		E53KAL34A2EA 134782		
				-	2 m connection cable		E53KBL34A2E 134815		
				-	Plug-in connection M12 x 1		E53KBL34A2EA 134816		
3-wire									
34 Ø									
10 - 30 V DC	25	Flush	NPN	-	2 m connection cable	Insulated material	E53KAL34T110 134783		1 off
				-	Plug-in connection M12 x 1		E53KAL34T110SD 134786		
				-	2 m connection cable		E53KBL34T110 134817		
				-	Plug-in connection M12 x 1		E53KBL34T110SD 134820		
			PNP	-	2 m connection cable		E53KAL34T111 134787		
				-	Plug-in connection M12 x 1		E53KAL34T111SD 134790		
				-	2 m connection cable		E53KBL34T111 134821		
				-	Plug-in connection M12 x 1		E53KBL34T111SD 134824		
	35	Non-flush	NPN	-	2 m connection cable	Insulated material	E53KAL34T110E 134784		1 off
				-	Plug-in connection M12 x 1		E53KAL34T110ED 134785		
				-	2 m connection cable		E53KBL34T110E 134818		
				-	Plug-in connection M12 x 1		E53KBL34T110ED 134819		
		PNP	-	2 m connection cable	E53KAL34T111E 134788				
			-	Plug-in connection M12 x 1	E53KAL34T111ED 134789				
			-	2 m connection cable	E53KBL34T111E 134822				
			-	Plug-in connection M12 x 1	E53KBL34T111ED 134823				

Engineering

Circuit diagram

Rated operational voltage	Contact	2 m connection cable	Plug-in connection M12 (front view plug)
2-Wire Sensors 20–250 V AC	N/O and NC		
3-Wire Sensors 10–30 V DC	N/O (NPN)		
	N/O (PNP)		
	NC (NPN)		
	NC (PNP)		

Technical data

			E53...A...	E53...T...
General				
Standards			IEC/EN 60947-5-2-EMC	
Ambient temperature		°C	- 25 - + 70	- 25 - + 70
Protection type			IP65	IP65
Mechanical shock resistance		g	30 Shock duration 11 ms	
Characteristics				
Repetition accuracy of S_n		%	10	10
Temperature drift of S_n		%	10	10
Switching hysteresis of S_n		%	20	20
Rated operational voltage		U_e	20 - 250 V AC	10 - 30 V DC
Residual ripple of U_e		%	10	10
Maximum load current	I_e	mA	300	300
Voltage drop at I_e	U_d	V	9	2
Switching Frequency		Hz	15	250
Min. load current	I_e	mA	5	-
Switching state display		LED	Red	Red
Connection			2-wire	3-wire
Material			Insulated material	Insulated material

Notes

Further technical data can be found in the Online Catalog at <http://de.ecat.moeller.net>

Dimensions

E53KAL18...
E53KBL18...

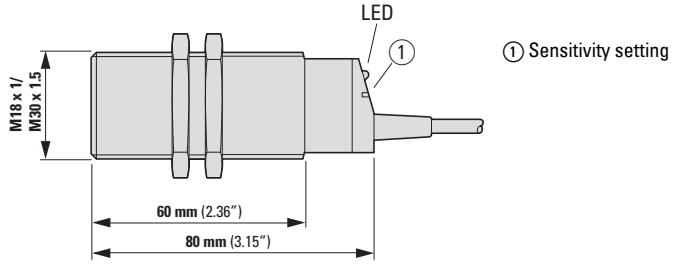
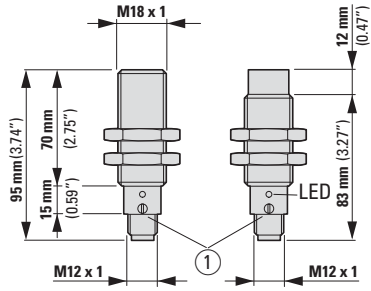

E53KAL30...
E53KBL30...

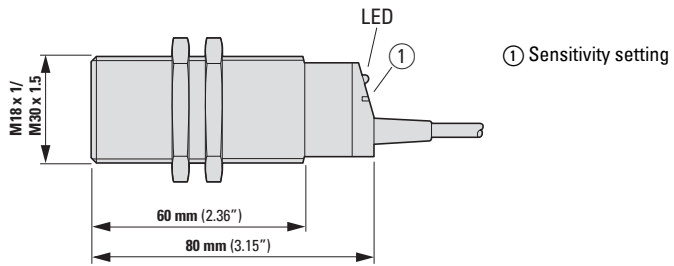
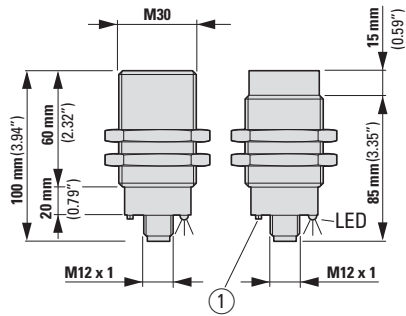

E53KAL34...
E53KBL34...
Plug-in connection M12 x 1

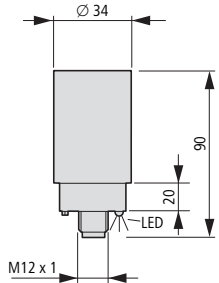



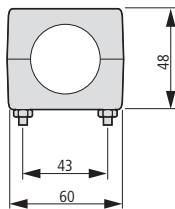

Fixing bracket included as standard

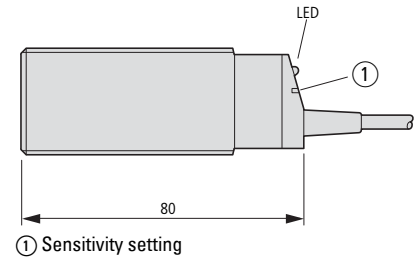







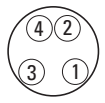
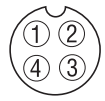
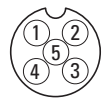
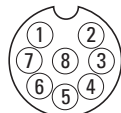



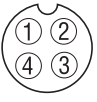
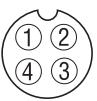
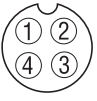
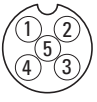





2 m connection cable



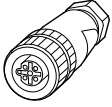















Ordering

Pin assignment	Description	Switching type	Voltage type	Pole	Length mm	For use with	Part no. Article no.	Price see price list	Std. pack
Connecting cables									
Open wire end									
Coupling, straight									
  <ul style="list-style-type: none"> 1 = Green 2 = Red/Black 3 = Red/White 	-	-	AC	3 pole	2000	AC sensors, 3 pole, M12	CSAS3F3CY2202 136265		1 off
	-	-			5000		CSAS3F3CY2205 136266		
	-	-			10000		CSAS3F3CY2210 136267		
 <ul style="list-style-type: none"> 1 = Brown 2 = Blue 3 = Black 4 = White 	-	-	AC	4 pole	2000	AC sensors, 4 pole, M12	CSAS4A4CY2202 136268		
	-	-			5000		CSAS4A4CY2205 136269		
	-	-			10000		CSAS4A4CY2210 136312		
 <ul style="list-style-type: none"> 1 = Brown 2 = White 3 = Blue 4 = Black 	-	-	DC	4 pole	2000	DC sensors, 4 pole, 2, 3 or 4-wire connection, M12	CSDS4A4CY2202 136292		
	-	-			5000	DC sensors, 4 pole, 2, 3 or 4-wire connection, M12	CSDS4A4CY2205 136294		
	-	-			10000	DC sensors, 4 pole, 2, 3 or 4-wire connection, M12	CSDS4A4CY2210 136296		
 <ul style="list-style-type: none"> 1 = Brown 2 = White 3 = Blue 4 = Black 	-	-	DC	4 pole	2000	DC sensors NanoView, 4 pole, M8, 24 AWG	CSNS4A4CY2402 100060		
	-	-			5000	DC sensors NanoView, 4 pole, M8, 24 AWG	CSNS4A4CY2405 100065		
	-	-			10000	DC sensors NanoView, 4 pole, M8, 24 AWG	CSNS4A4CY2410 100066		
 <ul style="list-style-type: none"> 1 = Brown 2 = No wire 3 = Blue 4 = Black 	-	-	DC	4-pole, 3-conductor	2000	DC sensors, 4 pole, 2 or 3-wire connection, M12	CSDS4A3CY2202 136287		
	-	-			5000		CSDS4A3CY2205 136288		
	-	-			10000		CSDS4A3CY2210 136289		
 <ul style="list-style-type: none"> 1 = Brown 2 = White 3 = Blue 4 = Black 5 = Green/Yellow 	-	-	DC	5 pole	5000	DC sensors, IntelliView E75-DST4..., 5 pole, M12	CSDS5A5CY2205 166986		
	-	-			10000		CSDS5A5CY2210 166987		
 <ul style="list-style-type: none"> 1 = White 2 = Brown 3 = Green 4 = Yellow 5 = Gray 6 = Pink 7 = Blue 8 = Red 	-	-	DC	8 pole	-	DC sensors, IntelliView E76-CLR..., 8 pole, M12	CSDS8A8CB2402 100578		
	-	-			-		CSDS8A8CB2410 100580		
	-	-			-		CSDS8A8CB2405 100579		

Pin assignment	Des- cription	Switch- ing type	Voltage type	Pole	Length mm	For use with	Part no. Article no.	Price see price list	Std. pack
Open wire end									
Coupling, angled									
  1 = Green 2 = Red/Black 3 = Red/White	-	-	AC	3 pole	2000	AC sensors, 3 pole, M12	CSAR3F3CY2202 136262		1 off
	-	-			5000		CSAR3F3CY2205 136263		
	-	-			10000		CSAR3F3CY2210 136264		
 1 = Brown 2 = White 3 = Blue 4 = Black	-	-	DC	4 pole	2000	DC sensors, 4 pole, 2, 3 or 4-wire connection, M12	CSDR4A4CY2202 136279		
	-	-			5000		CSDR4A4CY2205 136282		
	-	-			10000		CSDR4A4CY2210 136284		
 1 = Brown 2 = No wire 3 = Blue 4 = Black	-	-	DC	4-pole, 3- conduc tor	2000	DC sensors, 4 pole, 2 or 3-wire connection, M12	CSDR4A3CY2202 136272		
	-	-			5000		CSDR4A3CY2205 136273		
	-	-			10000	DC sensors, 4 pole, 2 or 3-wire connection, M12	CSDR4A3CY2210 136276		
 1 = Brown 2 = White 3 = Blue 4 = Black	LED	NPN	DC	4-pole, 3- conduc tor	5000	DC sensors, 4 pole, 2 or 3-wire connection, M12	CSDR4A3CY2205-LN 136274		
	LED	PNP					CSDR4A3CY2205-LP 136275		
 1 = Brown 2 = White 3 = Blue 4 = Black 5 = Green/Yellow	-	-	DC	5 pole	2000	DC sensors, IntelliView E75-DST4..., 5 pole, M12	CSDR5A5CY2202 166983		
	-	-			5000		CSDR5A5CY2205 166984		
	-	-			10000		CSDR5A5CY2210 166985		
Plug, straight									
Coupling, straight									
 Face view female  Face view male 	-	-	DC	4 pole	1000	DC sensors, 4 pole, 2, 3 or 4-wire connection, M12	CSDS4A4CY2201-D 136291		1 off
	-	-			1500		CSDS4A4CY2201.5-D 136316		
	-	-			3000		CSDS4A4CY2203-D 136293		
	-	-			5000		CSDS4A4CY2205-D 136295		
Plug, angled									
Coupling, straight									
 Face view female  Face view male 	-	-	DC	4 pole	1000	DC sensors, 4 pole, 2, 3 or 4-wire connection, M12	CSDR4A4CY2201-D 136278		1 off
	-	-			1500		CSDR4A4CY2201.5-D 136313		
	-	-			2000		CSDR4A4CY2202-D 136314		
	-	-			3000		CSDR4A4CY2203-D 136315		
	-	-			5000		CSDR4A4CY2205-D 136283		
material sold by the meter									
	-	-	AC, DC	3 pole	-	Plug, coupling M8 x 1	CS3ACY24XX 100033		1 off
	-	-		4 pole	-	Plug, coupling M12 x 1	CS4ACY22XX 100046		

	Description	Length mm	Switching type	Pole	For use with	Material	Part no. Article no.	Price see price list	Std. pack
Coupling									
	angled	-	-	4 pole	DC sensors, 4 pole, 2, 3 or 4-wire connection, M12	-	CSDR4 136271		1 off
		-	-		DC sensors, 4 pole, 2, 3 or 4-wire connection, M8	-	CSNR4 100047		
	straight	-	-	3 pole	DC sensors, 3 pole, 2 or 3-wire connection, M8	-	CSNS3 100054		
		-	-	4 pole	DC sensors, 4 pole, 2, 3 or 4-wire connection, M12	-	CSDS4 136286		
		-	-	-	-	-	CSNS4 100055		
Plug									
	angled	-	-	4 pole	DC sensors, 4 pole, 2, 3 or 4-wire connection, M12	-	CSDRM4 136285		1 off
		-	-		DC sensors, 4 pole, 2, 3 or 4-wire connection, M8	-	CSNRM4 100053		
	straight	-	-	3 pole	DC sensors, 3 pole, 2 or 3-wire connection, M8	-	CSNSM3 100067		
		-	-	4 pole	DC sensors, 4 pole, 2, 3 or 4-wire connection, M12	-	CSDSM4 136297		
		-	-	-	-	-	CSNSM4 100068		
Protection cap									
	Plug-in connection M12 x 1	-	-	-	M12 (micro) multi-connector strip Plug	-	CBMCAP 136298		1 off
		-	-	-	M12 (micro) multi-connector strip Coupling	-	CBCAP 136317		
	Plug-in connection M12 x 1	-	-	-	M12 sensors, inductive	-	E57KP12 136202		
		-	-	-	M18 sensors, inductive	-	E57KP18 136203		
		-	-	-	M30 sensors, inductive	-	E57KP30 136204		
Conduit adapter									
	Plug-in connection M12 x 1	-	-	-	M8 sensors	Metal	E57KC8 136187		1 off
		-	-	-	M12 sensors		E57KC12 136184		
		-	-	-	M18 sensors		E57KC18 136185		
		-	-	-	M30 sensors		E57KC30 136186		
		-	-	-	M30 sensors	Stainless steel	E58KC30 135754		
		-	-	-	-	-	-		

	Design (outer dimensions) mm	For use with	Material	Part no. Article no.	Price see price list	Std. pack
Fixing bracket						
	-	M8 sensors	Stainless steel	E57KM8 136191		1 off
	-	M12 sensors		E57KM12 136188		
	-	M18 sensors		E57KM18 136189		
	-	M30 sensors		E57KM30 136190		
	38 x 38 x 44	M18 sensors	aluminum	6161A-6501 135736		2 off
	76 x 38			6161AS5295 135737		
	38 x 38 x 44			6161AS7050 135741		
	69 x 76 x 64	M30 sensors	Metal	6167A-6501 135742		
	51 x 102 x 41 adjustable, insulated	M18 sensors	Stainless steel	E58KAM18 135749		1 off
	51 x 102 x 41 adjustable, not insulated	M18 sensors		E58KAM18U 135751		
	51 x 102 x 50 adjustable, insulated	M30 sensors		E58KAM30 135752		
	51 x 102 x 50 adjustable, not insulated	M30 sensors		E58KAM30U 135753		
	38 x 38 x 44 with ball joint	M18 sensors	Insulated material	E58KAM18B 135750		
	-	E71 NanoView series	Metal	E71-MTB1 100520		
	-	E75-PPA...	Metal	E75-MTB1 100537		
	-	E76-CLR... E75-PP1MP-M12	Metal	E76-MTB1 100538		
	53 x 44	Comet series	Stainless steel	6161AS5296 135738		
	53 x 44	Comet series	Stainless steel	6161AS5297 135739		

	Description	Design (outer dimensions) mm	For use with	Material	Part no. Article no.	Price see price list	Std. pack	
Replacement nuts								
	-	-	M8 sensors	Metal	E57KNM8 136194		2 off	
	-	-	M12 sensors		E57KNM12 136193		2 off	
	-	-	M18 sensors	Insulated material	E57KNC18 136192		2 off	
	-	-	M12 sensors	Stainless steel	E57KNS12 136195		2 off	
	-	-	M18 sensors		E57KNS18 136196		2 off	
	-	-	M30 sensors		E57KNS30 136197		2 off	
	-	-	M18 sensors E58-Serie		E58KNS18 135755		1 off	
	-	-	M30 sensors E58-Serie		E58KNS30 135756		1 off	
Sensor fixing								
	-	-	M8 sensors, inductive	-	E57KNZ8 136201		1 off	
	-	-	M12 sensors, inductive	-	E57KNZ12 136198			
	-	-	M18 sensors, inductive	-	E57KNZ18 136199			
	-	-	M30 sensors, inductive	-	E57KNZ30 136200			
Retro-reflector								
	Adhesive film	∅ 33 mm	Reflex photoelectric sensor with or without polarized filter	Insulated material	6200A-6504 135745		1 off	
	Adhesive film	∅ 61 mm			6200A-6505 135746			
	Screw mounting	∅ 61 mm			6200A-6502 135744			
	Screw mounting	∅ 63 mm			E65KR55 135758			
	Screw mounting	∅ 84 mm			6200A-6501 135743			2 off
	Screw mounting	∅ 84 mm			Plastic/metal	6200A-6506 135747		
	Screw mounting	38 x 81 mm		Insulated material	6200A-6507 135748		1 off	

Dimensions

Retro-reflector

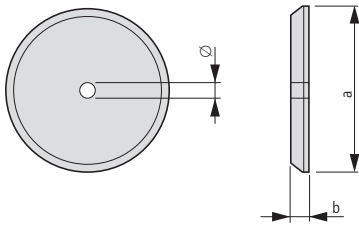

	a	b	∅
6200A-6501	3.30 (84)	0.35 (9)	0.20 (5)
6200A-6502	2.40 (61)	0.30 (7.5)	-
6200A-6504	1.30 (33)	0.25 (6)	-
6200A-6505	2.40 (61)	0.30 (7.5)	0.25 (6)
6200A-6506	3.30 (84)	0.30 (7.5)	0.20 (5)

E65KR55

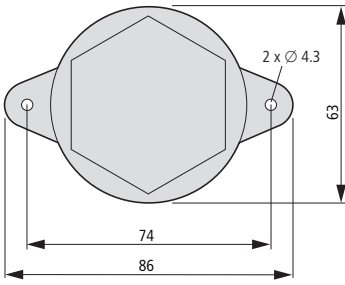

Fixing bracket

E58KAM18

E58KAM18U

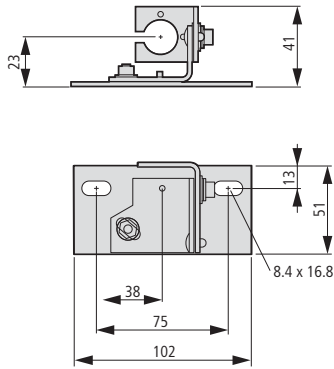

6161A-6501

6161AS-6501

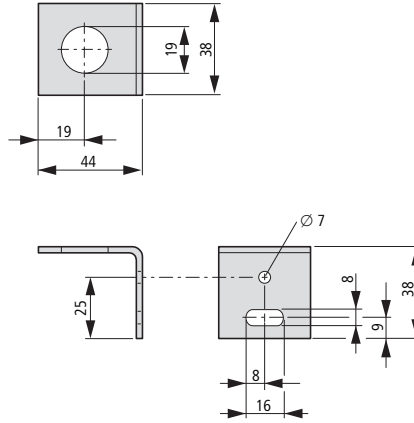

E58KAM30

E58KAM30U

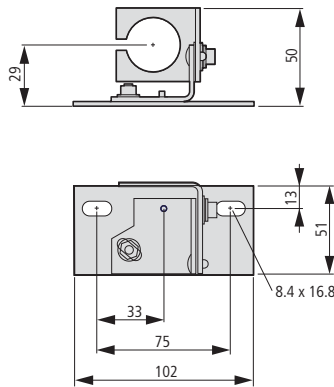

6167A-6501

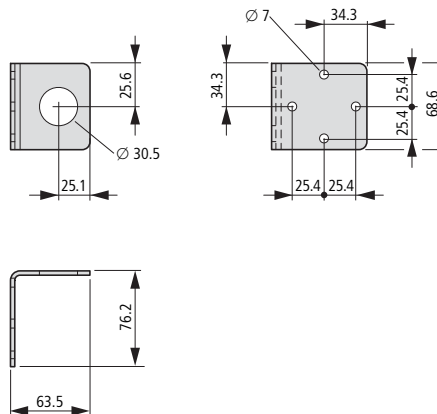

E58KAM18B

6161AS-7050

6161AS-5295

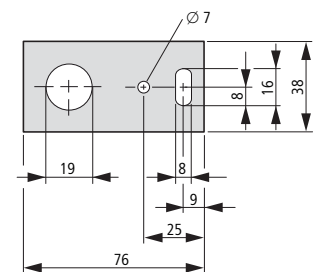
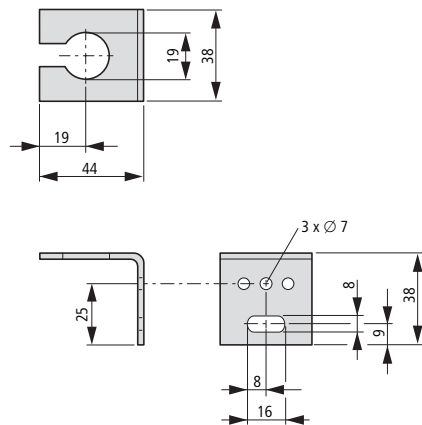
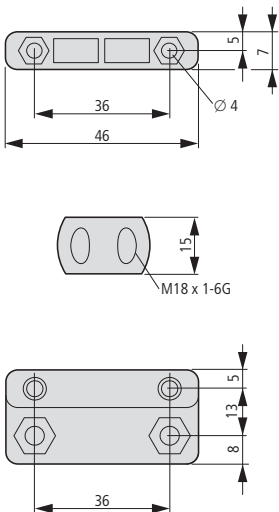

E57KM...

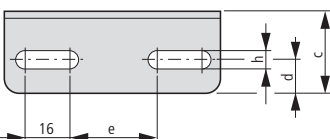
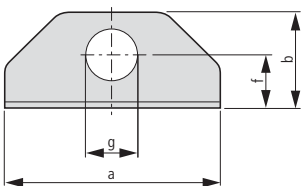

	a	b	c	d	e	f	g	h
8 mm	76	34	29	17	31	19	8	6
12 mm	76	34	29	17	31	19	12	6
18 mm	76	34	29	17	31	19	18	6
30 mm	108	55	45	25	51	29	30	7

Conduit adapter

E57KC...

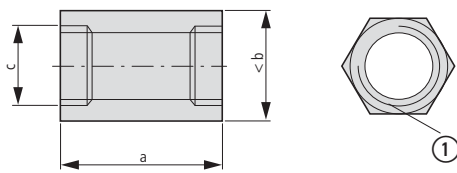

	a	b	c
8 mm	25	25	M8x1
12 mm	38	25	M12x1
18 mm	38	25	M18x1
30 mm	48	38	M30x1.5

① 1/2" - 14 NPT for conduit

E58KC30

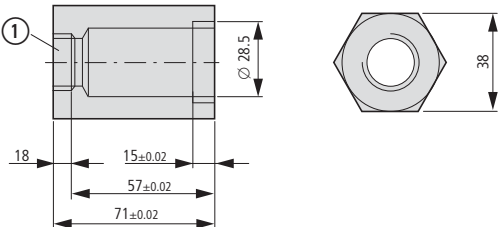

① 1/2" - 14 NPT for conduit

Sensor fixing

E57KNZ

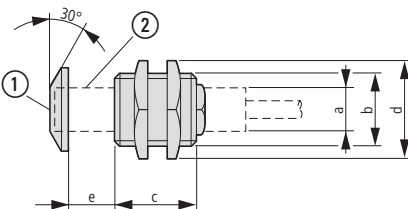

① Protection cap
② Overtravel

Sensor	a	b	c	d	e
8 mm	M8 x 1	M16x1.5	o.87 (22)	o.87 (22)	0.35 (9)
12 mm	M12x1	M22x1.5	o.87 (22)	1.12 (29)	0.41 (10)
18 mm	M18x1	M30x1.5	1.17 (30)	1.41 (36)	0.49 (12)
30 mm	M30x1.5	M47x1.5	1.47 (37)	1.72 (51)	0.57(15)

Connecting cables

Coupling straight, cable end open

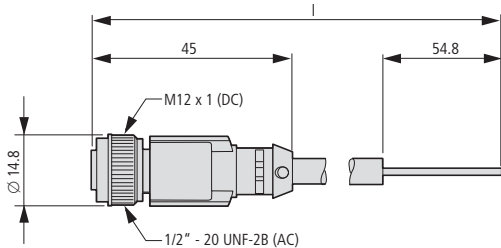

Coupling angled, cable end open

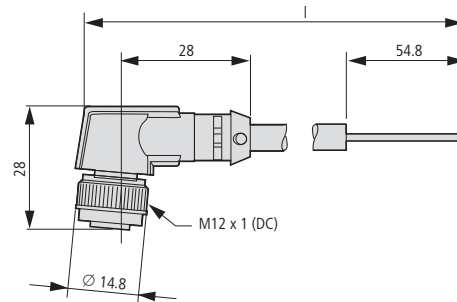

Straight coupling, straight plug

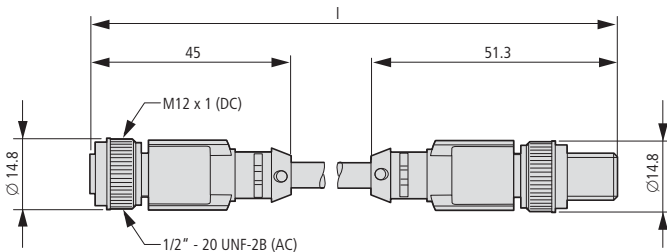

Coupling angled, angled

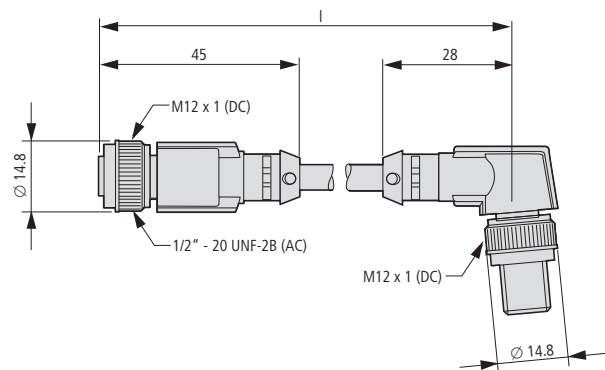

Basic Information

Sensors are devices that sense the presence or absence of objects. Sensors perform a number of functions in automated manufacturing and material handling systems. For example, sensors can determine if an object is present, if tooling is broken, or if product is running down a conveyor line.

A sensor can be thought of as an automatic switch. In a factory, a sensor can be used to detect a problem on the line and stop the line automatically.

Sensors have contributed significantly to recent advances in manufacturing technology. The use of sensors makes it possible to increase the degree of automation in processes and systems. In addition, it eliminates the need for human operators to monitor and control situations.

The two main categories of sensors are proximity sensors and light sensors.

Proximity Sensors



This type of sensor uses an electromagnetic or electrical field to detect when an object is near. There is no physical contact between the object and the sensor. Inductive proximity sensors detect only metal objects. Capacitive proximity sensors can sense both metallic and non-metallic objects.

Proximity sensors can be used, for example, to ensure that a part in a manufacturing process is aligned within a specific tolerance.

This type of sensor is generally used to sense at distances less than one inch (2.5 cm).

Photoelectric sensors



This type of sensor uses light to detect the presence or absence of an object.

A **thru-beam photoelectric sensor** uses two devices on opposite sides (a source and a detector).

Detection occurs when an object blocks or breaks the beam of light passing between them.



Light beam blocked: object detected

- ① Source
- ② Detector

A **diffuse reflective sensor** (proximity sensing) emits a beam of light that must be reflected by the target object in order for the object to be detected.

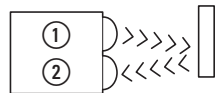
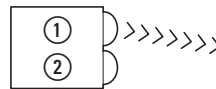

Reflected light beam: object detected

- ① Source
- ② Detector

A **retroreflective sensor** emits a beam of light that is reflected towards the sensor by a reflector. An object is detected when it blocks the beam of light between the sensor and the reflector. We will go over this type of light sensor in greater detail later on in this chapter.

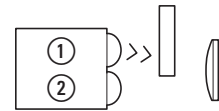
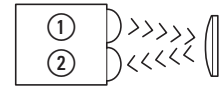

Light beam blocked: object detected

- ① Source
- ② Detector

Most electric garage door openers include a light sensor for safety reasons. If the light sensor's beam of light is blocked (by a child, for example) while the door is being closed, the sensor will tell the door opener to reverse the direction of the door's movement or to stop the door.

Although environmental factors can affect light sensors, these devices have a long sensing range. The objects they detect can be of any material.

Sensor Comparison

Each of the two sensor categories has its strengths and weaknesses. The table below provides you with a comparison.

	Proximity Sensors	Light sensors
Method of Detection	Electromagnetic/electrical field	Light beam
Sensing Range	Close: within 2.5 cm (1 in)	Far: can be 800 ft (240 m)
Target Material	Inductive: metallic only Capacitive: metallic and non-metallic	Can be affected by target surface, for example, if the target is shiny or transparent
Object Markings	Not able to detect	Able to detect
Cost	Low	Low to high depending upon sensing method
Sensor Size	Small to large	Very small (fiber optic) to large
Environmental Sensitivity	Inductive: electrical interference Capacitive: humidity	Light interference
Response Time	Milliseconds	Microseconds

Inductive Proximity Sensors

The inductive proximity sensor can be used to detect metal objects. It does this by creating an electromagnetic field.

With the ability to detect at close range, inductive proximity sensors are very useful for precision measurement and inspection applications.

Strengths and Weaknesses

Strengths

- Immune to adverse environmental conditions.
- High switching frequencies for fast processes.
- Can detect metallic targets through non-metallic barriers
- Long operational life with virtually unlimited operating cycles.
- Bounceless switch outputs; e.g., to PLCs.

Weaknesses

- Limited sensing range (maximum of 25 mm, also up to 100 mm in E56 series).
- Detects only metal objects.
- May be affected by metal chips accumulating on sensor face.

Scopes of application

Proximity sensors are used in a variety of applications. For example:

- Detecting the limit of a positioning table's travel
- Determining a speed by counting the teeth on a sprocket
- Checking whether a valve is fully open or closed

Proximity sensors can be used to detect the presence or absence of metallic workpieces or workpiece fixtures on conveyor belts.

Inductive sensors can be used to control robotic arms. They can be used, for example, to ensure that objects are actually gripped correctly.

In metal machining, proximity sensors can make sure the workpiece is mounted in the fixture correctly, and that the drill bit has not broken off.

How an Inductive Proximity Sensor Works

Inductive proximity sensors generate a high-frequency (HF) electromagnetic field. When a metal object is brought near the sensor's face, the field changes. The detector circuit detects this change and the sensor switches an output to a connected device. Each sensor has a specific sensing range, which ensures that metallic objects will be detected with utmost precision in a repeatable manner.

Surface mounting

Let's look at the components and the process step-by-step:

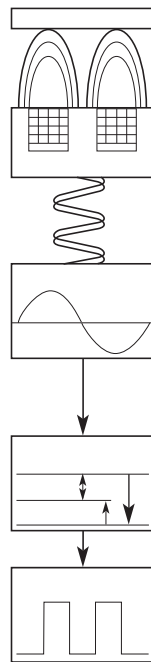

Components

A metal object, or target, enters the sensing field.

The **sensor coil** is a coil of wire typically wound around a ferrite core. If you could see the electromagnetic field created by it, it would be cone shaped. The target will pass through this field.

The ferrite core shapes the field and the size of the coil determines the sensing range.

The **oscillator circuit** makes the field oscillate at a specific high frequency (100 kHz to 1 MHz). The presence of metal in the field causes this vibration to change. Eddy currents, which take energy from the field, are induced on the target object. Accordingly, the metallic object causes a change in the magnetic field. This change creates a damping effect on the amount of signal that cycles back to the sensor coil. The amplitude is reduced accordingly.

The **detector circuit** detects this change and switches at a specific set-point value. This signal, in turn, produces a change at the switching output.

The output remains active until the target leaves the sensing field. The oscillator responds with an increase in amplitude, and when it reaches the setpoint value, the detector circuit switches. The output returns to its normal state.

Hysteresis

Hysteresis is a fixed distance between the ON and OFF points. If hysteresis were not included in a sensor's design, the output would continuously switch on and off when close to the operating point.

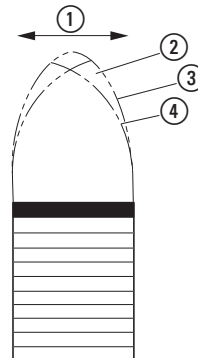

Hysteresis

- ① Direction of movement
- ② Hysteresis
- ③ operate point
- ④ release point

With hysteresis, the operate point and the release point are slightly different distances from the sensor face.

Proximity Sensor Types

Proximity sensors come in a wide variety of designs to meet the requirements of almost any industrial application.

- Tubular



This is the design of choice for a growing number of applications. The small size allows for easy mounting in a fixture or for use in tight spaces found on many assembly lines.

- Right angle tubular



This design enables mounting in tight locations.

- Plastic housing



This corrosion-resistant unit performs well in high wash-down areas or places where caustic chemicals abound.

- Pancake



The extra-large coil in this unit makes it possible to achieve the widest and tallest available sensing range of 100 mm. It is ideal for use in heavy industry applications and for the assembly of large components.

Inductive Proximity Sensor Influences

When applying inductive proximity sensors, it is important to understand the sensing range and the factors that influence that range. The sensing range refers to the distance between the sensor face and the target.

Four considerations are of particular importance when selecting and using proximity sensors:

- Target considerations (material, size, shape and approach)
- Coil size and screening
- Sensor mounting requirements
- Environment

Target Material

The target object's material will affect the maximum sensing range. If this maximum distance is exceeded, the damping effect needed to switch the sensor output will not be produced and the sensor will not detect the target object.

Proximity sensors work best with ferrous alloys. Though these sensors detect other metals, the range will not be as great. Generally, the less iron in the target, the closer the target has to be to the sensor to be detected.

Manufacturers generally provide charts showing the necessary correction factors for various types of metals when applying their sensors. Each sensor style will have a correction factor to enable calculation for a particular target material.

Correction factors

Multiply the sensing distance by the factor given below.

Target object	Sensor size				Limit Switch Style
	4 - 8 mm	12 mm	18 mm	30 mm	
Stainless Steel 400 ¹⁾	0.90	0.90	1.0	1.0	1.0
Stainless Steel 300 ²⁾	0.65	0.70	0.70	0.75	0.85
Brass	0.35	0.45	0.45	0.45	0.5
Aluminium	0.35	0.40	0.45	0.40	0.47
Copper	0.30	0.25	0.35	0.30	0.40

- ¹⁾ Stainless steel 400 series to ASTM A240, martensitic or ferritic, magnetizable.
 - ²⁾ Stainless steel 300 series to ASTM A240, austenitic, non-magnetizable.
- The index of stainless steels is provided in EN 10088-1.

Target Size

If the target object is smaller than the sensor's "standard target size," the sensing range will also be smaller. This is because a smaller target creates a weaker eddy current. However, a bigger target does not mean a longer sensing range.

The thickness of the target does not impact sensing range much. However, a very thin non-ferrous target can actually achieve a greater sensing range because it generates an eddy current on both sides.

So, how big should the target be? The rule of thumb is: the size of the sensor's diameter, or three times the sensor's sensing range, whichever is greater.

Target Shape

The shape of the target can have an impact on the sensing range. A round object, or an object with a rough surface can affect the damping effect of the sensor, and may require a closer sensing distance. Using a larger sensor size or an extended range sensor will also minimize this effect.

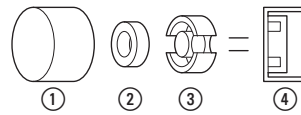

Coil/Core Construction

- ① Protection cap
- ② Coil
- ③ Cup core
- ④ Sensor head

A protective **cap** prevents dust or other environmental hazards from entering the sensor.

Screening

The coil can be screened in order to focus the field strength. In standard range sensors, the ferrite cup core will shape the field in such a way that it is emitted straight forward from the sensor's sensing face - i.e., "screened" in a manner of speaking.

An extended-range coil/core assembly does not use the standard cup core, but rather just a ferrite core. This unshielded sensor makes it possible to expand the sensing range. The reason why is that there is less ferrite to absorb the electromagnetic field. Accordingly, the sensor's effective range will become wider and a little longer.

The decision to use an unshielded sensor will impact the mounting of the sensor, as we will discuss that next.

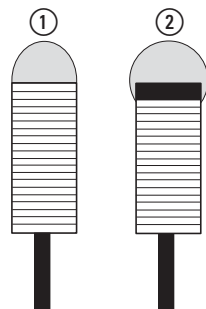

Screening

- ① flush mounting (screened)
- ② non-flush mounting (unscreened)

Mounting Considerations

A flush-mounted screened sensor can be fully embedded in a metal mounting block without affecting the sensor's sensing range.

In contrast, an unshielded sensor will require a certain distance (metal-free zone) around it - this distance will depend on the sensor's sensing range. Otherwise, the sensor will sense the metal fixing and be continuously operating.

Accordingly, a sensor's design (screening) will affect the way it is mounted.

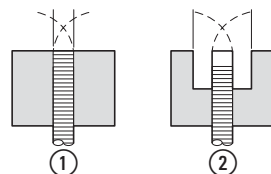

Clear Zone

- ① flush mounting (screened)
- ② non-flush mounting (unscreened)

Target Approach

How the target approaches the sensor matters as well. When an object comes at the sensor straight on, that's an **axial approach**. With this type of approach, you will need to protect the sensor physically. Allow for 25% over-travel.

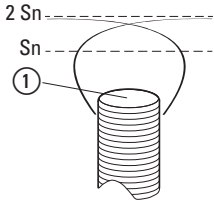

Axial Approach

- ① sensing face

Hysteresis tends to be greater for an axial approach than a lateral approach.

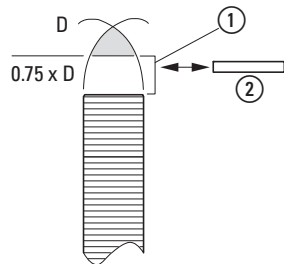

Lateral Approach

- ① recommended detection range
- ② Target

On a slide-by, or **lateral approach**, the target approaches the center axis of the sensing field from the side (lateral).

The target should not pass closer than the basic tolerance built into the machine design.

For both approach types, it is necessary to ensure that the distance between the target object and the sensor face does not exceed 75% of the sensing range.

Coil/Core Size

An important factor in the range of the sensor is the construction of the coil/core. An open coil with no core will produce a field that could be actuated by a target from any direction. That wouldn't be recommended for industrial applications.

For an inductive proximity sensor, the sensor coil that generates the field fits inside of a ferrite core. This cup-shaped piece of ferrite material is called a **cup core**. This core directs the field and shapes it.

Mounting two sensors closely together can also be a problem. If you position two proximity sensors too close together—either side by side or facing each other head to head—the two fields will clash with one another. Each sensor needs to be mounted at least three times its own sensing range away from the other. The use of an alternative frequency head on one of the sensors will prevent adjacent sensors' sensing fields from interacting.

Mounting Ranges

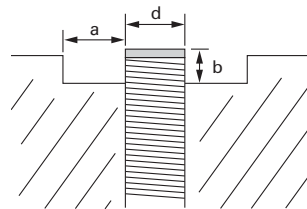

	a	b
shielded	0	0
unshielded	2 x Sn	Cap height
semishielded	Sn	d

Environment

The sensor's environment can affect its performance dramatically. Some of these environmental factors are:

- Debris
Debris can accumulate on the sensing cap, changing the range of the sensing field. In an application where metal chips are created, the sensor should be mounted to prevent those chips from building up on the sensor face. If this is not possible, then coolant fluid should be used to wash the chips off the face. An individual chip generally doesn't have enough surface area to cause the sensor to turn on, but several of them could extend the sensing range and interfere with the accuracy of the sensor.

- Electrical cables
Magnetic fields caused by electrical wiring located in the vicinity may affect sensor operation. If the field around the wires reaches an intensity that would saturate the ferrite or the coil, the sensor will not operate. Sensors used in areas with high frequency welders can also be affected. To compensate for a welder, weld field immune sensors can be installed. Or, if the sensor is used with a PLC, a time delay can be programmed to ignore the signal from the sensor for the time period that the welder is operating.

- High frequency source (HF)
RF sources (such as walkie-talkies) can produce signals that use the same frequency as the sensor's oscillator circuit. This is called radio frequency interference (RFI). Sensors have integrated EMC protection components in order to provide maximum protection against radio frequency interference and sensor malfunctions.

Electrical interference from nearby motors, solenoids, relays and the like could have an affect on sensor operation as well.

- Induced line or current spike
An induced line or current spike can cause a false operation of the sensor. This spike can be produced by the electrical arc created when an electrical/mechanical switch or a contactor closes. If the lines connecting the sensor and these devices are adjacent and parallel to one another, the spike will affect the sensor. Most codes and specifications call for a separation of control and power leads.

- Ambient air temperature
The ambient temperature can affect sensing range. The effect is referred to as temperature drift. The sensing range can change by as much as ±10%.

Component variations, power-line noise, ambient air temperature, and the effects of normal machine wear can all contribute to changes in sensing ranges. Because of this, sensors must be selected in such a way that they will detect target objects at 75% of the nominal switching distance and will be deactivated at 125%.

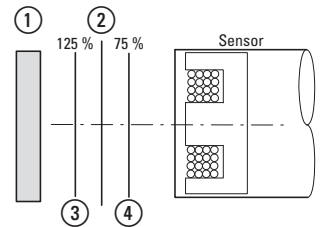

Sensing Distance Tolerances

- ① Target
- ② Nominal sensing range
- ③ Maximum reset distance
- ④ Maximum real operating range

Capacitive Proximity Sensors

Capacitive proximity sensors basically have the same function as inductive proximity sensors, but their detection method is considerably different.



Capacitive Proximity Sensors

Capacitive proximity sensors are designed to detect both metallic and nonmetallic targets. They are ideally suited for liquid level control and for sensing powdered or granulated material.

Strengths and Weaknesses

Consider these strengths and weaknesses of the capacitive proximity sensor:

Strengths

- Can detect both metallic and non-metallic objects at greater ranges than inductive sensors.
- High switching rate for rapid response applications (counting).
- Can detect liquid targets through non-metallic barriers (glass, plastic).
- Long operation life, solid-state output for "bounce free" signals

Weaknesses

- Affected by varying temperature, humidity and moisture
- Not as accurate as inductive proximity sensors

Scopes of application

Here are some examples showing how the detection power of capacitive proximity sensors is used:

- Detecting liquid levels in order to prevent overflowing and dry-running is a frequent application in the packaging industry.
- Checking material quantities in order to make sure, for example, that the label roll on a labeling line is not completely used up.
- Counting applications, such as tracking units passing a point on a conveyor.
- Injection molding machines: detecting the fill level of the plastic granules in the feed hopper.

Capacitive Proximity Sensor Operation

A capacitor consists of two metal plates separated by a insulator (called a **dielectric**). The function of this type of sensor is based on dielectric capacitance, which is the ability of a dielectric to store an electrical charge.

The distance between the plates determines the ability of the capacitor to store a charge.

The capacitance value changes when an object enters the electric field. This change is evaluated for the switching

function.

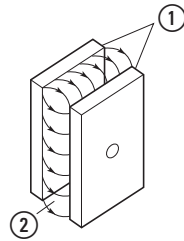

Capacitor

- ① Plates
- ② Dielectric

When this principle is applied to the capacitive proximity sensor, one capacitive plate is part of the switch, the enclosure (the sensor face) is the insulator. The target is the other "plate." Earth is the common path.

Capacitive proximity sensors can detect any target that has a dielectric constant greater than air. Liquids have high dielectric constants. Metal also makes a good target.

The capacitive proximity sensor has four basic elements: a sensor (which is a dielectric), an oscillator circuit, a detector circuit and an output circuit.

When an object approaches the sensor, the capacitor's permittivity changes and the vibration in the oscillator circuit starts. This means that capacitive sensors work exactly the opposite way as inductive proximity sensors, in which the vibration is damped when a target object approaches.

Oscillator Damping

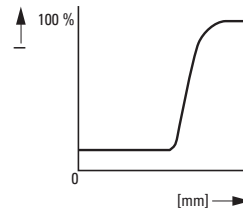

Inductive
I = Current in oscillator circuit

The **detector circuit** monitors the oscillator's output. When it detects sufficient change in the field, it switches on the output circuit.

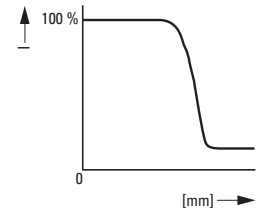

Capacitive
I = Current in oscillator circuit

The output circuit remains active until the target leaves the sensing field. The oscillator then responds by reducing the amplitude. The detector circuit is switched off if the change in the electric field becomes too small.

The internally fixed difference between the vibration's ON and OFF amplitudes forms the hysteresis.

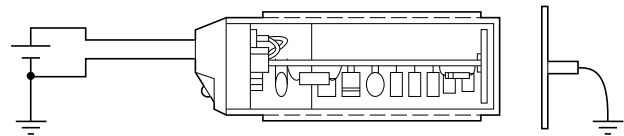

Capacitive Proximity Sensor Operation

Capacitive Proximity Sensor Influences

Typically, capacitive sensors have a greater sensing range than inductive sensors.

Sensing distance for capacitive proximity sensors is dependent on plate diameter. With inductive proximity sensors, the size of the coil is the determining factor.

Typical Proximity Sensing Ranges

non-flush sensor with Ø	Inductive	Capacitive
18 mm	8 mm	15 mm
30 mm	15 mm	25 mm
34 mm	-	35 mm

Sensitivity Adjustment

Most capacitive proximity sensors are equipped with sensitivity adjustment potentiometers. In inductive sensors, the coil size is the decisive factor. Since the sensor measures a dielectric gap, the sensing range needs to be adjusted in line with the various relevant ambient conditions.

Target Material and Size

A capacitive sensor should not be hand-held during set up. Because your hand has a dielectric constant greater than air, the sensor may detect your hand rather than the intended target.

Capacitive sensors can detect both ferrous and non-ferrous materials equally well. There is no derating factor to be applied when sensing metal targets. But, other materials do affect the sensing range.

Because they can be used to detect liquid through a nonmetallic material such as glass or plastic, you need to ensure that the sensor detects just the liquid, not the container. The transparency of the container has no effect on the sensing.

For all practical purposes, the target size can be determined in the same

manner as was discussed in "Target Size" on Page page 104 for inductive proximity sensors.

Environment

Many of the same factors that affect inductive proximity sensors, also affect capacitive sensors, only more so.

- Embeddable mounting—capacitive sensors are generally treated as unscreened devices, and therefore, are not embeddable.
- Deposits / chips: They are more sensitive to metallic and nonmetallic chips and residue.
- Adjacent sensors—more space between devices is required due to the greater, unscreened sensing range
- Target background—because of both the greater sensing range, and its ability to sense metallic and non-metallic materials, greater care in applying these sensors is needed when background conditions are present
- Ambient atmosphere—the amount of humidity in the air may cause a capacitive sensor to operate even when no target is present
- Welding magnetic fields—capacitive sensors are generally not applied in a welding environment
- Radio Frequency Interference (RFI)—in the same way that inductive proximity sensors are affected, RFI interferes with capacitive sensor circuitry

Light sensors

Light sensors can be used in a wide variety of applications. They can detect objects more quickly and at longer distances than many competing technologies. This is why light sensors have quickly become one of the most frequently used automatic detection methods in manufacturing.



Scopes of application

Some of the common uses for light sensors include:

- **Material handling:** A sensor can ensure that products move along a conveyor belt in an orderly manner. The sensor will stop the operation if a jam occurs. In addition, individual objects can be counted as they move down the flat conductor.
- **Packaging:** Sensors can check whether containers have been filled, labeled, and sealed correctly.

- **Machine operation:** Sensors can monitor a machine's proper operation and ensure that the required materials are present and that tools are in good condition.
- **Paper Industry:** Sensors can detect web flaws, web splice, clear web and paper presence, while maintaining high web speeds.

Design Flexibility

Light sensors are available in a wide variety of designs. Sources and detectors can be arranged in a multitude of manners in order to meet the requirements of the application in question.

Operating modes

We will briefly introduce you to these modes, and fully explain them later (→ Page 107).

Operating mode	Description	Operating mode	Description
<p>Thru-beam photoelectric sensors</p>	<p>A source unit in one location sends a light beam to a detector unit in another location. An object is detected when it passes between the source unit and the detector unit, interrupting the light beam.</p>	<p>Diffuse reflective sensor</p>	<p>The light source and the detector are located in a single housing. If a target object moves in front of the optical sensor, it will directly reflect the beam of light back to the detector.</p>
<p>Polarized retroreflective arrangement</p>	<p>The light source and the detector are located in a single housing. The emitted beam of light is mirrored by the polarizing reflector with a phase offset of 90°. The target object blocks the polarized beam of light.</p>	<p>Background suppression (Perfect Prox)</p>	<p>This is a special type of diffuse reflective sensor that consists of two detectors. This sensor offers reliable detection of target objects in a defined sensing range and at the same time ignores objects outside of this range.</p>

Basic Operation of Light Sensors

The operation of the light sensor is quite simple. A source light-emitting diode (LED) sends a beam of light, which is picked up by a photodetector.

When an object moves into the path of the light beam, the object is detected. Let's look at how a light sensor works.

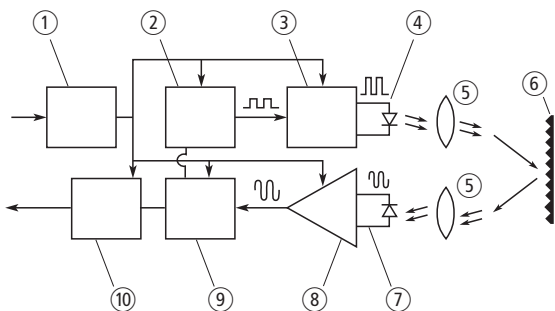

- ① Power supply
- ② Modulator: generates pulses to cycle amplifier and LED at desired frequency.
- ③ Amplifier
- ④ LED
- ⑤ Lens
- ⑥ Target object or reflector
- ⑦ ⑧ Detector: Either a photodiode or a photo-transistor device, selected for a

- maximum sensitivity at the source LED's emitted light wave-length. Both the source LED and the detector have protective lenses.
- When the detector picks up the light, it sends a small amount of current to the detector amplifier.
- ⑧ Detector Amplifier: Blocks current generated by the background light. It also provides amplification of the signal received to a usable level, and







- sends it through to the demodulator.
- ⑨ Demodulator: Sorts out the light thrown out by the detector from all other light in the area. If the demodulator decides the signals it receives are okay, it signals the output.
- ⑩ Output: Performs switching routine when directed to do so by the demodulator.

The Light Source

Today's light sensors use a light-emitting diode (LED) to produce their beam of light. Using LEDs offers many significant advantages:

- A LED can be rapidly switched and instantly turned ON and OFF
- .Extremely small
- Consume very little power
- Generate a negligible amount of heat.
- Life exceeds 100,000 hours (11 years) continuous use.

Light Sensors Styles and Uses

	Design/model series	Application
	Tubular Comet series	Small, easy to mount body enables mounting within machinery and other tight places. This sensor comes end sensing and right angle view sensor face, depending upon the type of mounting required.
	Harsh operational conditions E58-Series	Heavy-duty construction makes this sensor ideal for rugged environments.
	E65-SM-Series	A family of high performance DC light sensors in an economical compact enclosure. Diagnostic LEDs for correct target sensing.
	Fiber Optics	Made for fast response and for sensing in very tight areas. The cables are made of individual glass or plastic fibers and contain no electronics. Accessories to Comet series
	Miniature E71 series NanoView	A complete line of miniature light sensors for optimum placement and protection with no compromise in performance.
	Long-range sensors E67 series	The E67 series reliably detects target objects within its sensing range independently of variations in color, reflectance, contrast, and surface shape. Its Perfect Prox technology enables flawless background suppression, which makes these sensors ignore objects that are barely outside the target range.

Fiber Optics

Applying fiber optic technology to light sensors means applications with space restrictions are not a problem. A fiber optic cable can detect objects in locations too jammed for a standard sensor. Fiber optic cable is available in sizes as small as 0.002 inches (0.05 mm) in diameter.

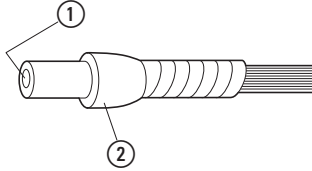

Glass Fiber Optic Cable

- ① Glass fiber embedded in insulated material
- ② Stainless steel sheath

A glass fiber optic cable is made up of a large number of individual glass fibers, sheathed for protection against damage and excess flexing.

Because light—rather than current—travels down these cables, the signal is unaffected by electromagnetic interference (EMI) and vibration.

Fiber optics can withstand high temperatures; standard glass up to 480°F (249°C) and specialized high temperature versions up to 900°F (482°C). Glass fibers can stand up to the harsh wash-down chemicals used in many food, beverage and pharmaceutical applications.

However, glass fibers have their disadvantages. They have a limited sensing distance, so they can be used only in tight areas. The maximum distance when using the thru-beam mode is 380 mm. In addition, these sensors have a relatively small sensing field. Also, small drops of water and dirt smudges can affect glass fibers applications.

Modes of Detection

In most applications, light sensors generate an output any time an object is detected.

Light operated or dark operated

"Light operated" means that an output signal will be generated if the light sensor receives light.

"Dark operated" means that an output signal will be generated if the light sensor does not receive any light.

• Light operated

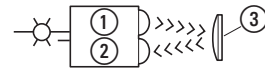

Reflected beam of light:
Activated output signal

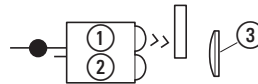

Blocked beam of light:
No output signal

• Dark operated

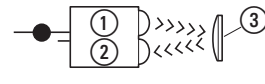

Reflected beam of light:
No output signal

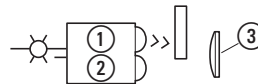

Blocked beam of light:
Output signal activated

- ① Source
- ② Detector
- ③ Reflector

Operating modes

On page 107, we briefly discussed the four basic operating modes used with light sensors. These are:

- Thru-beam photoelectric sensors
- Retroflective sensing sensor (polarized)
- Diffuse reflective sensor
- Background suppression (Perfect Prox)

Thru-beam photoelectric sensor

Source and detector units face one another across an area. The column of light traveling in a straight line between the two lenses is the effective sensing beam. An object crossing the path has to completely block the beam to be detected.

Strengths:

- Long sensing distance (up to 800 ft)
- Highly reliable
- Can "see" through opaque objects.

Weaknesses:

- Two components to mount and wire.
- Alignment could be difficult with a longer distance detection zone.

Function:

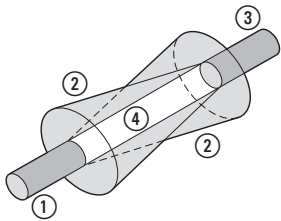

Normal state

- ① Station
- ② Field of view
- ③ Detectors
- ④ Effective light beam

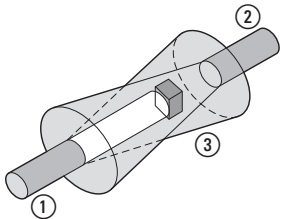

Target detected

- ① Station
- ② Detectors
- ③ Object blocks beam of light.

Retroflective sensing sensor, polarized

The source and detector are placed on the same side of the object to be detected, parallel to each other. A reflector is on the other side. This reflector sends the emitted light back to the detector.

When a target object passes between the source/detector unit and the reflector, the beam is no longer reflected, and the target is sensed. The target has to block the entire beam.

In certain cases, target objects with a shiny surface can result in false positives by activating the retroflective sensing sensor. A polarized retroflective sensing sensor can be used to prevent this. The polarizing filter on the sensor will ensure that the sensor will only detect light that has been offset by the reflector with a phase offset of 90°.

Strengths:

- Medium range sensing distance.
- Low cost.
- Ease of installation.
- Alignment does not need to be exact.
- A polarizing filter can be used to ensure that shiny surfaces will be reliably detected.

Weaknesses:

- Reflector must be mounted.
- Problems detecting clear objects.
- Dirt on reflector can hamper operation.
- Not suitable for detecting small objects.

Function:

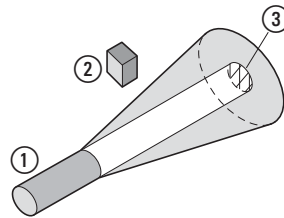

Normal state

- ① Source/detector
- ② Target
- ③ Retro-reflector

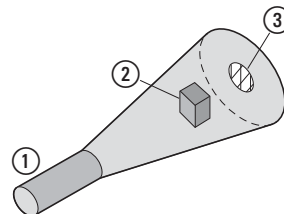

"Target object detected" state

- ① Source/detector
- ② Target object preventing reflection; i.e., target object detected.
- ③ Retro-reflector

Diffuse reflective sensor

The source and detector are positioned on the same side of the target. The two components are aligned so that their fields of view cross. When the target moves into the area, light from the source is reflected back to the detector.

Strengths:

- Application flexibility.
- Low cost.
- Easy installation.
- Easy alignment.
- Many varieties available for many application types.

Weaknesses:

- Short sensing distance (under 10 ft).
- Sensing distance depends on target size, surface and shape.

Function:

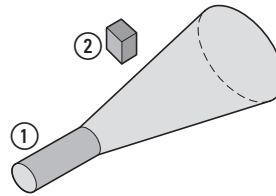

Normal state

- ① Source/detector
- ② Target

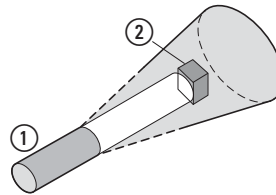

Target object detected

- ① Source/detector
- ② Target object reflecting beam of light; i.e., target object detected.

Background suppression (Perfect Prox)

This detection mode is a special type of diffuse reflective sensor. It combines extremely high sensing performance with a sharp optical cut-off. This enables the sensor to reliably detect target objects independently of their color, degree of reflection, contrast, and surface texture and ignore objects that are immediately outside the target range.

This method uses two different photo-detectors. For the Perfect Prox unit with a six-inch (150 mm) range, the near detector has a range of 0 to 24 inches (0 to 610 mm). The far detector has a range of 6 to 24 inches (150 to 610 mm).

Objects closer than six inches are detected only by the near sensor. Objects between 6 and 24 inches are detected by both detectors.

If the near-detector signal is stronger than the far-detector signal, the sensor output will be ON. If the far-detector signal is stronger than or equal to the near-detector signal, the sensor output will be OFF. The result is a sensor with a high light intensity difference over 150 mm combined with a sharp cut-off.

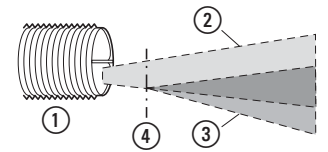

Perfect Prox Sensor

- ① Sensor
- ② Near sensing range
- ③ Far sensing range
- ④ Cut-off distance

Excess gain

Definition

The term "excess gain" is used to indicate a light sensor's excess light, i.e., the light that goes beyond the quantity of light required to detect an object.

A excess gain of "1" for a specific range means that the quantity of light available is exactly enough to detect an object within the range in perfect conditions. In other words, the range at which the light intensity difference is "1" equals the sensor's maximum range.

Every sensor model comes with a excess gain diagram that can be used to determine the excess gain for the sensing distance used in a specific application.

However, we have to take into consideration the following real-world variables:

- Target size
- Target color
- Target surface texture
- Ability to block the beam of light
- Background
- Application environment

In the real world, there is contamination—dust, humidity and debris—that can settle on the lenses and reduce light transmission. Furthermore, each individual target may vary slightly from the next in color, reflectivity or distance from the sensor.

If you use a sensor with a excess gain of exactly "1," it is highly likely that the target object will not be detected reliably. To be on the safe side, you will need a sensor with the largest possible excess gain at the range you will be using. This ensures the sensor will continue to operate reliably when you need it. If the degree of soiling or pollution increases, you will need a larger excess gain in order to compensate for the decrease in "visibility."

Thru-beam photoelectric sensor

The excess gain for this type of sensor is the easiest to measure. The excess gain is almost exclusively a function of the distance between the source and detector.

When implementing the excess gain for an application, start with the excess gain chart for the thru-beam sensor. Then consider:

- Misalignment of the two units.
- Dirt in the environment reduces gain.

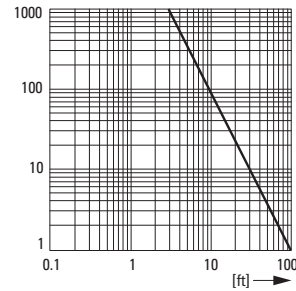

Typical Gain Curve for a Thru-Beam

If these sensors are spaced 30 ft (9 m) apart, the excess gain at that distance would be an excess gain of "10".

Diffuse reflective sensor

Almost every diffuse reflective sensor has a uniquely specific combination of lenses and beam angles. Accordingly, almost every sensor will have its own specific excess gain curve.

Diffuse reflection ranges:

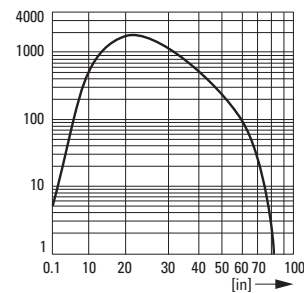

Perfect Prox long range sensor, example

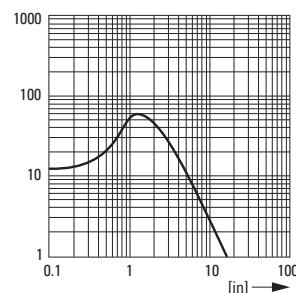

Short Range

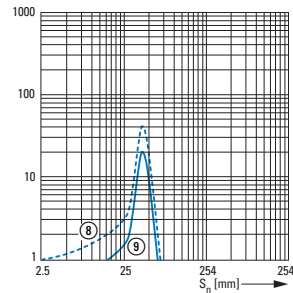

Diffuse reflective sensor

- ⑧ Comet 13102A typical
- ⑨ Comet 13102A minimum

Sensing range referenced to 90% reflective white target.

The excess gain of a short-range sensor is large within the focused range and then decreases quickly. The source's beam of light and the detector's field of view converge a short distance behind the lenses. The energy present in that area is very high, allowing the detection of small targets. The sensor will ignore objects in the near background.

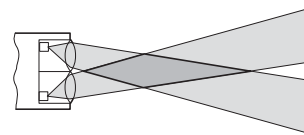

Short Range

In the case of a long-range sensor, the source's beam of light and the detector's field of view will be close to each other on the same shaft. The sensor's detection capabilities will extend across a larger distance. The excess gain will peak a few centimeters away from the sensor and then decrease slowly as the distance increases.

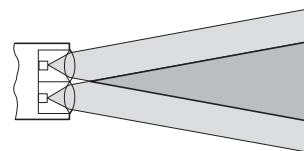

Long range

To sense into holes or cavities, or to pick up very small objects, use a focused diffuse reflective sensor. Or, a sensor with a very small light spot size. The source and detector are positioned behind the lens in order to focus the energy to a point. The excess gain is extremely high at this point and then drops off on either side of the sensing zone.

Retroreflective sensing sensor

Calculating the excess gain for a retroreflective sensing sensor is done with a method similar to that used for diffuse reflective sensors.

With this type of sensor, excess gain and range are related to the light bouncing back from the reflector. Maximum operating range also depends upon lens geometry and detector amplifier gain.

The effective beam is defined as the actual size of the reflector surface. The target must be larger than the reflector before the sensor will recognize the target and switch its output.

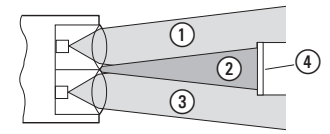

Effective Reflex Sensor Beam

- ① Emitted light beam
- ② Effective light beam
- ③ The detector's field of view
- ④ Retro-reflector

Retroreflector / Corner cube retroreflector

The range and excess gain of a retro-reflector will depend on the reflector's quality.

Retroreflectors deliver the highest signal return to the sensor. A corner reflector has 2,000- to 3,000 times the reflectivity of white paper.

A retroreflector is made up of three adjacent faces that are arranged at right angles to each other (hollow corner retroreflector).

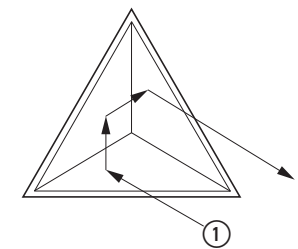

Retro-reflector

- ① Light beam

When a ray of light strikes one of the three adjoining sides, the ray is reflected to the second side, then to the third, and then back to its source in a direction parallel to its original course. Thousands of these prisms are molded into a rugged plastic reflector or vinyl tape material.

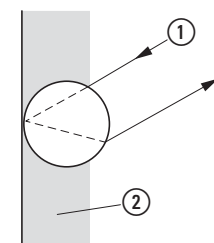

Glass Bead

- ① Light beam
- ② Opaque material

There are reflectors made up of glass beads placed on flat conductors that are intended for use in dispensers for package coding on conveyors. These reflectors are also available in sheets, and can be cut to size as necessary. The bead surface is typically rated at 200 to 900 times the reflectivity of white paper.

Only retroreflectors can be used with polarized retroreflective sensing sensors. The light reflected by the prisms in the corner cube retroreflector will have a phase offset of 90°. The polarizing filters on the source and detector will only let the light reflected by the retroreflector through. Glass bead reflectors cannot be used with polarized retroreflective sensing sensor.

Contrast

Contrast measures the ability of a light sensor to detect an object. A sensor's contrast is the ratio of the excess gain in lighted conditions to the excess gain in dark conditions. A ratio of 10:1 is desired. Contrast is important when a sensor has to detect semi-transparent objects or extremely small objects.

Each operating mode handles contrast differently.

- Thru-beam photoelectric sensor and retroreflective sensing sensor
These operating modes are affected by:
 - Light permeability of an object or surface
 - Size of an object in relation to the beam size

- Diffuse reflective sensor
This operating mode is affected by:
 - Distance of the object or surface from the sensor
 - Color or material of the object or surface
 - Size of the object or surface
- The ideal application provides infinite contrast ratio of the detection event. This is the case when 100% of the light beam is blocked in the retroreflective or thru-beam operating mode. For diffuse sensing, this occurs when nothing is present. Taking the contrast ratio into account is important when the above situation is not the case (e.g., when detecting semitransparent objects). In certain cases, it may be necessary to use special low-contrast sensors designed for the specific application in question (e.g., featuring

a detector for transparent objects).

Environment

The list below ranks the level of pollution in a range of typical application environments.

The excess gain required in order to overcome atmospheric pollution will be larger the further down the list you go.

In addition, the light source and the reflector used in retroreflective sensing sensors and thru-beam photoelectric sensors may be located at different spots with different degrees of pollution.

For outdoor use, the environment can range from lightly dirty to extremely dirty.

Level of Contamination Ranking

Ranking	Description	Minimum required excess gain
Relatively clean	No dirt buildup on lenses or reflectors	1.5 x
Slightly dirty	Slight buildup of dust, dirt, oil, moisture, and so on, on lenses or reflectors. Lenses should be cleaned on a regular schedule.	5 x
Moderately dirty	Obvious contamination of lenses or reflectors. Lenses are cleared occasionally or when necessary.	10 x
Very dirty	Heavy contamination of lenses. Heavy fog, mist, dust, smoke or oil film. Minimal cleaning of lenses takes place.	50 x

Sensor Output Circuits

Sensors interface to other control circuits through the output circuit. The control voltage type is a determining factor when considering output type. Control voltage types, whether AC, DC or AC/DC, can be categorized as either load-powered sensor or line-powered sensor.

Load-Powered—Two-Wire Sensors

Load-powered devices are similar to limit switches. They are connected in series with the controlled load. These devices have two connection points to the circuit and are often referred to as two-wire switches. The operating current is drawn through the load.

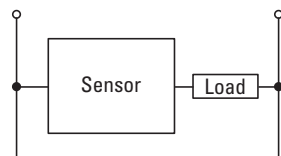

Load powered/two-Wire switch

When the switch is not operated, it must draw a minimum operating current referred to as off-state leakage current. Off-state leakage current is also sometimes referred to as residual current. This current is used to keep the sensor electronics active while it "looks" for a target. Residual current is not a problem for loads such as relays, motor starters, and so on (with low impedance). However, loads such as inputs of programmable logic controllers with high impedance require a leakage current of lower than 2 mA.

Currents larger than this may result in input devices such as PLCs (programmable logic control) interpreting the residual current as an ON signal. Most sensors require a residual current of 1.7 mA. If a particular PLC requires less than 1.7 mA, a load resistor can be connected in parallel to the input for the PLC load. The resistor lowers the current seen by the PLC so it doesn't false trigger.

The current needed to sustain the sensor when a target object is present is called minimum load or holding current. Depending on the specific sensor specifications, this current will be about 5 mA. The sensor will not work if the current drawn by the load is not large enough. Sensors with a 5 mA or less minimum holding current can be used with PLCs without concern.

Line-Powered—Three-Wire Sensors

Line-powered sensors derive their power from the line and not through the load. They have three connection points to the circuit, and are often referred to as three-wire switches.

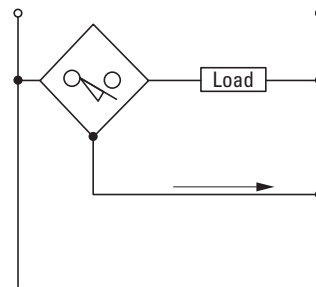

Line-powered/three-wire switches

The operating current the sensor pulls from the line is 20 mA.

Two-Wire Sensors

Although most sensors are three-wire devices, two-wire devices are also required sometimes. They are designed to be easy replacements for limit switches without the need to change wiring and logic.

Since two-wire sensors take their operating power from the load circuit, there is a voltage drop (approx. 7-9 V in AC-powered devices) across the switch when it is on.

If multiple two-wire switches are connected in series with the load, the voltage drop across the switches will increase. If multiple two-wire sensors are connected in parallel, the leakage current will increase. This needs to be taken into account when it comes to activating PLC inputs, for example.

Applications

Broken Tool Detection

Description	Catalog Number
E58 Perfect Prox Sensor	E58-30DP... E58-18DP...

This sensor is used to sense for the presence of the bit on a mill. The high sensing power and background suppression of the Perfect Prox allows reliable detection through high levels of cutting fluids, while ignoring objects just beyond the bit. The rugged harsh duty sensor survives constant exposure to lubricants, cutting fluids and flying metal chips.

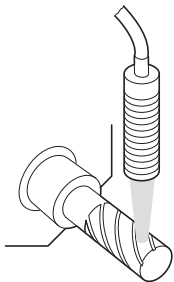

Broken Tool Detection

Description	Catalog Number
Tubular inductive sensor	E57... or iProx

A tubular sensor is used to detect the presence of a drill bit — should the drill bit be broken the sensor would signal a controller.

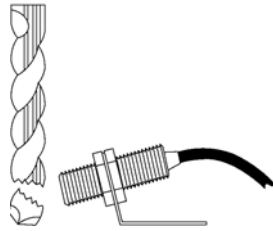

Machining process

Description	Catalog Number
Tubular inductive sensor	E57... or iProx

A ferrous only sensor is used in a process where aluminum is being machined. The ferrous only sensor ignores the aluminum (non-ferrous) chips from the machining process and only detects the ferrous target.

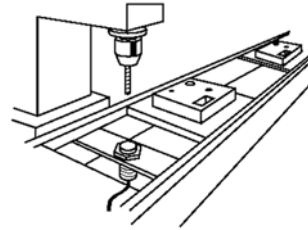

Tool Position

Description	Catalog Number
Tubular inductive sensor	E57... or iProx

A tubular sensor is used to detect the position of a tool chuck.

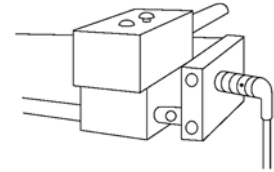

Bottle Filling Detection

Description	Catalog Number
Clear object sensor	E71-CON or E71-COP

A clear object sensor is used to sense the presence of bottles at a filling operation. The sensor offers high reliability in sensing clear bottles of different colors and thicknesses.

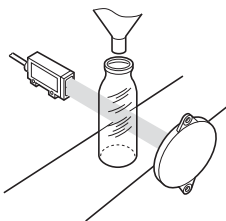

Process control engineering

Description	Catalog Number
Tubular capacitive Sensor	E53...

A capacitive sensor used to verify fill level of bottled water on a filling process line.

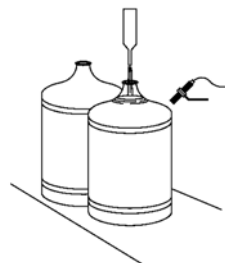

Conveyor System Control

Description	Catalog Number
Tubular inductive sensor	E57... or iProx

A tubular inductive sensor is used to detect the presence of metal carriers holding parts to be machined.

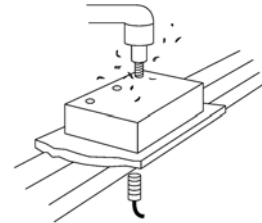

Stack Height Control

Description	Catalog Number
Comet series thru-beam photoelectric sensor	
Station	11100A
Detectors	12100A

A set of thru-beam photoelectric sensors determines the height of a scissor lift. For example, when the control is set for "dark-to-light" energize, the lift rises after a layer has been removed and stops when the next layer breaks the beam again.

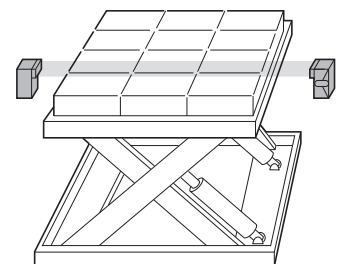

Carton Fill-Level Detection

Description	Catalog Number
Comet visible retro-reflective sensing sensor	14102A...
Comet diffuse reflective sensor with background suppression (Perfect Prox)	13103A...
Retro-reflector	6200A-6501

Two sensors work together to inspect the fill level in cartons on a conveyor. A diffuse reflective sensor senses the position of the carton and energizes the sensors located over the contents. If the sensor does not "see" the fill level, the carton does not pass inspection.

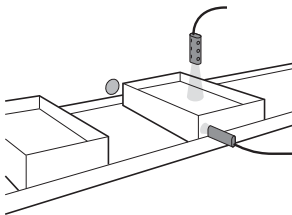

Lid Detection

Description	Catalog Number
Tubular inductive sensor	E57... or iProx

Two sensors are used to detect a can on a conveyor belt and to check whether it has a cover.

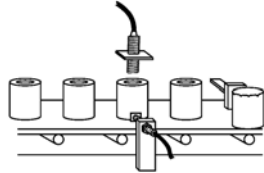

Tollbooth Control

Description	Catalog Number
Perfect Prox long range sensor	E67-LRDP...

The long range polarized retroreflective sensing sensors are used for the time control of a toll barrier. As soon as the car that has paid passes, the barrier closes in order to ensure that the next car stops. With the initiator E67 Long Range Perfect Prox you can mount the sensor on just one side instead of both. Plus with Perfect Prox, the E67 will detect cars with different colors and finishes while ignoring all other background objects. The rugged design makes it also suitable for continuous operation in extreme weather conditions.

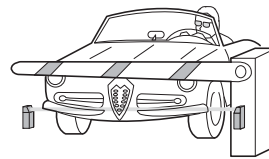

Liquid Level Detection

Description	Catalog Number
Tubular capacitive Sensor	E53...

A pair of capacitive sensors are used to sense high and low liquid levels in a tank through a sight glass. This arrangement starts a pump to fill the tank when the lower sensor is energized and shuts the pump off when the top sensor is energized.

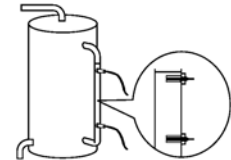

Bulk Material Detection

Description	Catalog Number
Tubular capacitive Sensor	E53...

A capacitive sensor is used to control fill level of solids such as plastic pellets in a hopper or bin.

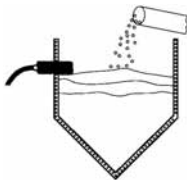

Parts Presence

Description	Catalog Number
Limit switch, inductive sensor	E57...
Comet Perfect Prox	1310...
Inductive sensor iProx	E59-M...

A sensor configured as a limit switch can be used to detect whether a component is present in an automatic assembly machine. The Comet detects all materials, colors and services and masks out the background. The iProx can be programmed to detect a particular material and thus to ignore all other materials.

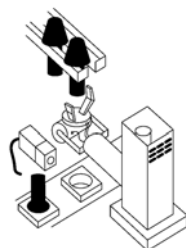

Parts Presence

Description	Catalog Number
Comet diffuse reflective sensor (Perfect Prox), 100 mm	13101A...

The sensor detects components with different heights from approx. 13 to 76 mm in a channel and can mask out the channel. Installation is simple and does not require any drilling or cutting of the channel.

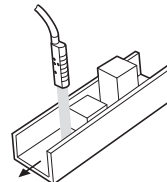

Filter Paper Length Control

Description	Catalog Number
A focused Comet diffuse reflective sensor	13102A...

A focused diffuse reflective sensor interfaces with a programmable controller to measure a specific length of corrugated automotive filter paper. The controller detects the presence or absence of a corrugation. When a predetermined number of corrugations has been detected, the programmable controller directs a shear to cut the paper.

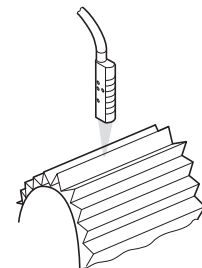

Speed monitoring

Description	Catalog Number
Tubular inductive sensor	E57... or iProx

A tubular sensor is used to detect the presence of set screws on a shaft hub providing a control device with signals for speed regulation or detection of rotation.

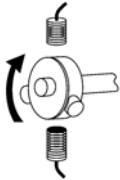

Motion Control

Description	Catalog Number
Tubular inductive sensor	E57... or iProx

A pair of tubular sensors is used to determine full open and fully closed valve position.

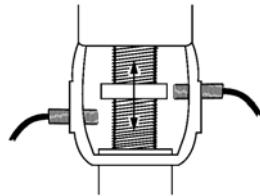

Paper detection

Description	Catalog Number
Comet Perfect Prox, 50 mm series, right angled	13104R...

Right angle viewing and compact size allow the sensor to be mounted in the tight confines of paper handling systems. High resolution and sharp optical cut-off ensure that background machinery will be ignored while paper will be detected regardless of color and texture.

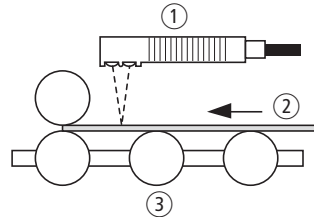

Clear Plastic Web Break Detection

Description	Catalog Number
Comet series 150 mm focus diffuse reflective sensor	13107A...

The clear web is detected by an extremely sensitive diffuse reflective sensor. Its short detection range makes it immune to reflective objects in the background. The extremely high excess gain helps it ignore reflection caused by fluttering of the web.

Damage Warning

Description	Catalog Number
Comet E58 series thru-beam photoelectric sensor	
Station	E58-30TS...
Detectors	E58-30TD...

Source and detector are mounted at opposite ends of a long warehouse storage shelf with the beam situated a safe distance below overhead obstacles (lighting, cable ducts, gas lines, etc.). If a forklift operator interrupts the beam while moving a load, a siren or flashing light will warn him to stop before any damage occurs.

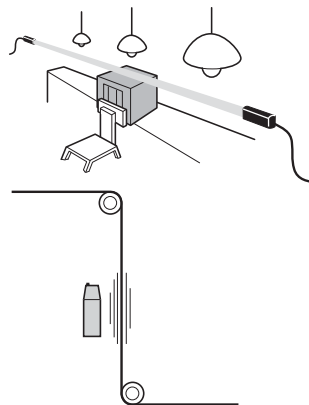



Worldwide export of machines and plants

European machine and system building and worldwide exports are closely related. Even if you don't export your machines at present, you should be prepared for it in the future. Eaton provides switchgear and protective devices with all the essential approvals and certificates for machine and system building. In most countries around the world, conformity with international standards is the sole requirement for successful exports. This is because components in these locations are governed by compliance with well known and established IEC standards. In this respect, the European CE mark is not only the passport for exports within Europe but also far beyond its borders.



World market equipment for machine building

Nearly all the switchgear and protective devices of Eaton's Moeller® series are world market devices. Each product line thus carries all the approvals and certification marks required for worldwide use.

These product lines include those for

- Pilot devices, limit switches
- Contactors and various timing and special relays
- Motor-protective circuit-breakers and relays
- Electronic components and systems.

With circuit-breakers and switch-disconnectors, Eaton offers IEC devices for use in most countries in the world and NA devices with virtually the same dimensions and the same accessories for the North American market. This considerably simplifies device selection since the North American standards often involve the need for considerably different technical specifications.

Electrical engineering products and their applications are not harmonized internationally.



The greatest differences to the IEC world are in North America, i.e. the USA and Canada. For many newcomers to the export business, it is initially surprising to experience the very different approaches and solutions.

Special components, such as handles for main switches that can only be operated by the intentional switching of an

additional handle when the control panel door is opened, may sometimes be required for export to North America. Likewise, the European motor-protective circuit-breaker is only accepted with an upstream protective device or with larger air and creepage distances at the incoming terminals. Eaton is the competent partner of choice for export-related issues here.

Qualified information is a critical key to success

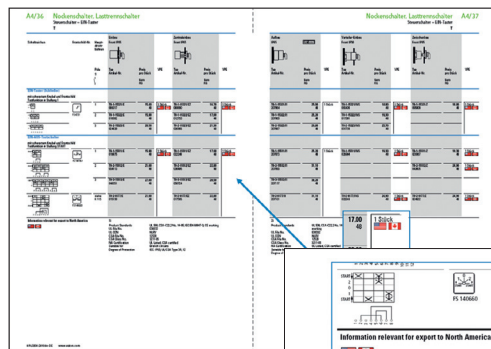

The Eaton Main Catalogue for Moeller® series products provides reliable information for machine and panel builders on the approval of components deployed for North American market. Each selection page provides information such as the relevant product standard, the E-File Number, the Category Control Number or the CSA Class Number. Many customers incorporate this information in their parts lists in order to be well prepared for the acceptance procedures.

Information relevant for export to North America

UL File No.	UL CCN	CSA File No.
UL 508; CSA-C22.2 No. 14-05; IEC/EN 60947-3; CE marking	E36332	12528
NLRV	3211-05	3211-05
UL Listed, CSA certified	UL Listed, CSA certified	UL Listed, CSA certified
Branch circuits	Branch circuits	Branch circuits
IEC: IP65; UL/CSA Type 3R, 12	IEC: IP65; UL/CSA Type 3R, 12	IEC: IP65; UL/CSA Type 3R, 12

Up to 13 data items are listed here for each product, such as the suitability for use in feeders or branch circuits, the maximum operating voltage, or the North American degree of protection, such as UL / CSA Type 4X. The Main Catalogue also contains a glossary with explanations of the American terms.



The link <http://www.moeller.net/eaton-approbationen/en/index.jsp> shows the relevant approvals or permits for each component type. This therefore enables you to view the certificates provided or, depending on the test authority, also the product report. The information given is the same as what is provided in the databases of the authorities.

Anyone wishing to avoid unfortunate experiences, should make use beforehand of the large number of publications that Eaton is offering on the issue of exports to North America. They contain the implementation of the codes & standards and a description of different practices.

These technical articles can be accessed via <http://www.moeller.net/en/company/news/publications/index.jsp> They can be downloaded or ordered free of charge.



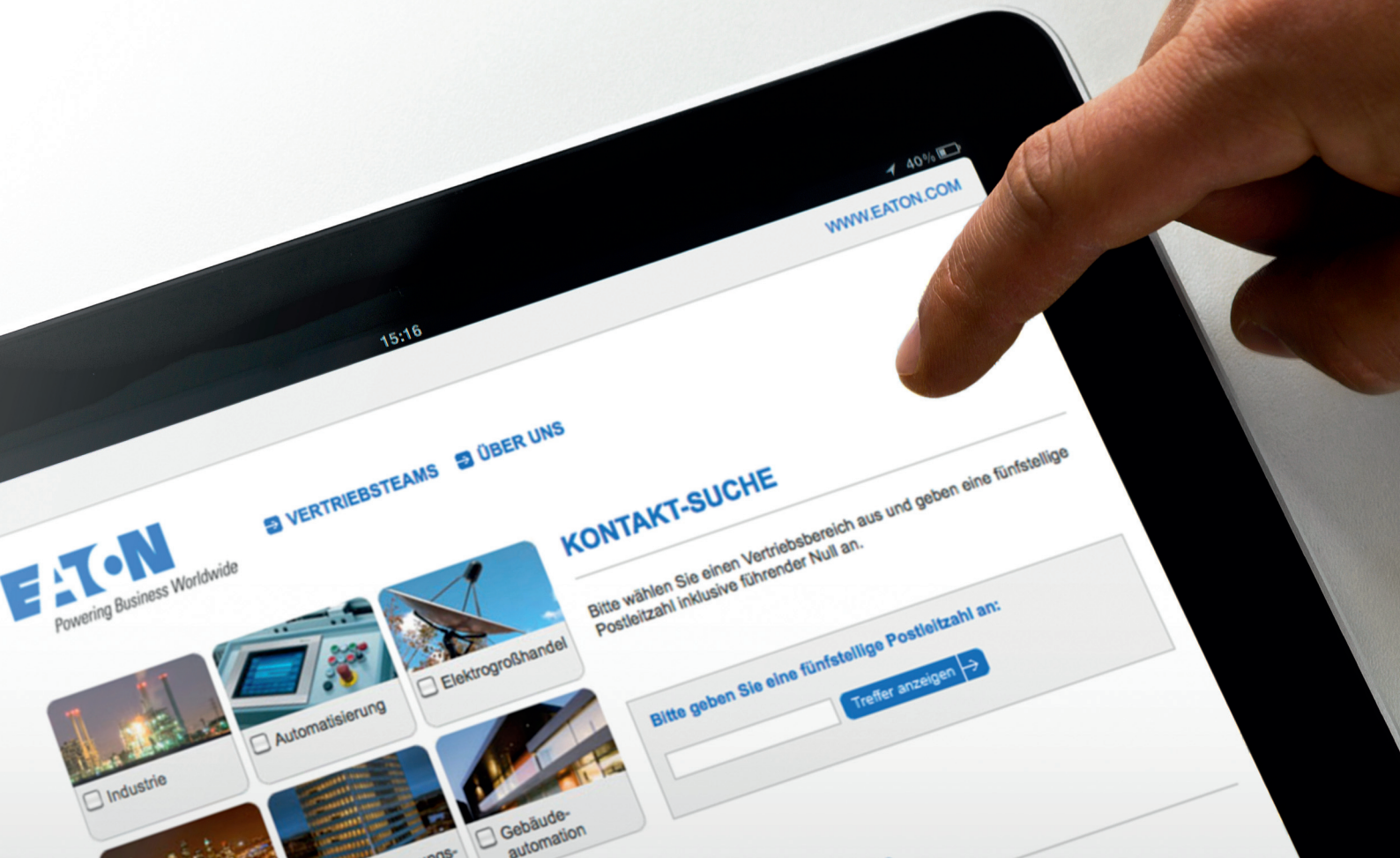

How to find the right contact:

At Eaton, an efficient customer relationship management is standard practice.

This guarantees you our support right from the start of any new project. Use these contact addresses to find your personal customer contact:

In just a few steps we can direct you to specialist local support specifically for your business sector.

Your customer contact in your region:

→ <http://salesbonn.moeller.net>

Your customer contact worldwide:

→ www.eaton.eu/electrical/contact

Service and consulting for UPS systems and hydraulic solutions.

Further developing relations with our customers is particularly important to us. Your requirements and suggestions will be passed on promptly to the relevant specialists. After all, we take up the challenges you give us as if they were our own.

Are your questions about uninterruptible power supplies (UPSs)?

Technical support

If you have any questions about our products and for technical advice send an email to our support team:

supportgermany@eaton.com

or contact our telephone hotline at

Tel.: +49 (0)7841 604 - 334

Service

If you have a problem or a fault on one of our products contact us by email:

servicegermany@eaton.com

or contact us by phone at:

Tel.: +49 (0)7841 604 - 334

We can be contacted here between
Monday – Thursday from 08.00 – 17.00 CET
and Friday from 08.00 – 16.00 CET.



Are your questions about hydraulic solutions?

Please contact the help desk of our Customer Service in Baden-Baden. This service will put you in touch with a customer contact in your locality.

Our customer service:

Eaton Hydraulics Group

Dr.-Reckeweg-Straße 1

D-76532 Baden-Baden

Tel.: +49 (0)7221 682 - 0

Fax: +49 (0)7221 682 - 788

Email: customersupportemea@eaton.com

Eaton's After Sales Service

This is the new name of Moeller's tried and trusted Field Service. Only the name has changed. The reliable and first-class service has stayed the same. Further information and general terms and conditions can be found at www.moeller.net/en/support/fieldservice/index.jsp.

Service specialists

Use our service personnel. Extensive know-how, combined with many years of experience and state-of-the-art equipment to help you find a solution for your tasks.

Material

Components, assemblies and spare parts for the Eaton product range are available for your applications.

Service products

Eaton's After Sales Service offers the right service packages for your products.

Hotline

Free hotline for round-the-clock support.

+49 (0)180 522 3822 (24/7)

0.12 euros per minute for calls from within the German Telecom network

Onsite service

Repair and replacement service for Eaton devices.

Repairs

Onsite service, analysis, conversions, expansions and maintenance.

Online services

Downloads, FAQs and interactive troubleshooting

Eaton is dedicated to ensuring that reliable, efficient and safe power is available when it's needed most. With unparalleled knowledge of electrical power management across industries, experts at Eaton deliver customized, integrated solutions to solve our customers' most critical challenges.

Our focus is on delivering the right solution for the application. But, decision makers demand more than just innovative products. They turn to Eaton for an unwavering commitment to personal support that makes customer success a top priority. For more information, **visit www.eaton.eu**.

To contact an Eaton salesperson or local distributor/agent, please visit www.eaton.eu/electrical/customersupport

Changes to the products, to the information contained in this document, and to prices are reserved; so are errors and omissions. Only order confirmations and technical documentation by Eaton is binding. Photos and pictures also do not warrant a specific layout or functionality. Their use in whatever form is subject to prior approval by Eaton. The same applies to Trademarks (especially Eaton, Moeller, Cutler-Hammer). The Terms and Conditions of Eaton apply, as referenced on Eaton internet pages and Eaton order confirmations.

Eaton Industries GmbH

Hein-Moeller-Str. 7-11
D-53115 Bonn/Germany

© 2013 by Eaton Corporation
All rights reserved
Printed in Germany 04/13
Publication No.: CA053003EN-INT
Doku/DHW/ip/mp 04/13
Article No.: 171796



Eaton is a registered trademark of Eaton Corporation

All other trademarks are property of their respective owners.