



I N D E X

COMPANY PROFILE	1 - 4
CTS SERIES SCREW CLAMP TERMINAL BLOCKS	5 - 72
CY SERIES SCREW TERMINAL BLOCKS	73 - 90
CX SERIES SPRING CLAMP TERMINAL BLOCKS	91 - 140
CP SERIES PUSH-IN TERMINAL BLOCKS	141 - 168
STUD & BOLT TYPE TERMINAL BLOCKS	169 - 193
MELAMINE TERMINAL BLOCKS	194 - 214
ACCESSORIES	215 - 236
PROFESSIONAL TOOLS	237 - 239
DIN RAIL MOUNTED SOCKETS & SWITCHES	241 - 242
TECHNICAL REFERENCE	243 - 255
ALPHABETICAL INDEX	256 - 262

INTRODUCTION

Established in 1978, Connectwell is the leading manufacturer of Terminal Blocks in India. This superior range of Terminal Blocks is complimented by a large range of Interface Modules, Surge Protection Devices and SMPS (Switched-Mode Power Supplies).

Connectwell over the years has undergone constant evolution of infrastructure, systems and personnel. This evolution is exemplified by its high quality products and a team of professionals which is always looking ahead of everyday challenges, willing to change adapt and create.

Reputed product approvals and certifications like UL, CSA, VDE, ATEX and CE and quality systems which adhere to ISO 9001:2015 verify the quality level that can be expected of Connectwell.

More than four decades of incessant dedication and commitment have made Connectwell a synonym for . . . THE RIGHT CONNECTION

PRODUCT LINES

Terminal Blocks

Interface Modules

SMPS (Switched-Mode Power Supplies)

Surge Protection Devices (SPD)

VISION

Connectwell is committed to provide safe, reliable and efficient control & connection solutions in line with ever changing technology requirements. We shall...

Empower domestic and global customers with products of the highest quality standards, with a competitive edge and at superior service levels.

Create a work culture that encourages individual growth, team spirit and creativity; helping us overcome challenges and attain goals.

Deploy fair & ethical business practices for the growth of our vendors and maximize returns to our stakeholders.

Contribute towards the welfare of our community and follow environment friendly practices.

MISSION

Connectwell is dedicated to achieve customer satisfaction by, supplying the Right Product, at the Right Time and at the Right Cost.





INFRASTRUCTURE

From product conceptualization to realization, we are well equipped with the latest software and high precision machinery to meet the requirements of our customers. Some of these strengths are listed below



Injection and Compression Moulding: Highly automated production floors with CNC moulding machines supported by high accuracy moulding auxiliaries ensures repeatable high quality production.

Sheet Metal Processing - Our strength in sheet metal processing lies in the ability to use high speed multi station and multi form presses to create complex metal components with a very high degree of accuracy. We also have the capability to carry out a number of post forming processes like tapping, welding etc.

Automatic Mechanical Assembly: A very large volume of our products are assembled automatically on automatic assembly lines, which also carry out 100% functional testing of these products, assuring quality and reliability.

Tool Development & Maintenance: At our state of the art production tool room we produce both sheet metal tools and plastic processing moulds at extremely high accuracy levels. In addition, a maintenance tool room supports production areas and ensures continuity of production.



Product Design & Development: Our team works on a Product Life cycle Management platform which enables easy use of various mechanical and electrical design and simulation tools in addition to being able to efficiently manage projects and engineering data.

This ensures that we are able to produce high quality products and tools in shorter time frames, allowing us to better service our customer's needs.



TEAM CONNECTWELL

Team Connectwell comprises of a blend of experienced and young personnel. This perfect blend is what provides us the stability and energy to look ahead of every day challenges, to constantly evolve and create.

Our HR processes ensure special attention to training for personnel across all levels. Our team constantly enhances itself through training sessions on subjects as varied as systems, soft skills, product & domain knowledge etc.

Our in house training centre is frequently used by external and internal trainers to carry out such training sessions.



QUALITY & SYSTEMS

At Connectwell we endeavour to keep evolving our systems in line with the latest standards and technology.

In addition to being an ISO 9001:2015 certified organization, all our business processes are mapped into various internal and customer facing IT systems, ranging from a world class ERP, CRM & PLM systems to extremely user friendly customer portal, product configurators and product website.

Our quality control laboratory has been approved for 'Witness Test Data Program' by Underwriters Laboratories (UL). This ensures that the quality testing carried out by our laboratory is not only accurate but also acceptable to the most stringent third party product testing organizations.

Connectwell products carry third part approvals from the most trusted organizations in the world, including but not being limited to UL, CSA, VDE, ATEX and CE.



PRESENCE

Our customers range from the largest to the smallest entities in the below industries

| Power Generation, Transmission & Utilities |

| Oil & Gas | Industrial & Process Automation |

| HVAC | Elevators & Escalators |

| Material handling | Railways & Metros |

| Ship Building & Aviation |



REACH

We serve our customers through an expansive dealer network spread across India & the globe and also through our direct offices.

In India, we have more than 150 distributors located across all major towns & cities. In addition to our distributor network, our Sales & Marketing personnel located in all major cities of India interact with customers directly, to understand and meet their requirements.

Internationally, Connectwell is present directly in China, Brazil & Middle East through its subsidiaries and personnel. In addition we reach more than 60 other countries through distributors.

Some of the reputed names who we work with regularly are listed below

| Siemens | Emerson | Indian Railways | Honeywell |

| Crompton Greaves | Rockwell Automation | ABB |

| Schneider Electric | Bharat Heavy Electrical Limited |

| Larsen & Toubro |

CORPORATE SOCIAL RESPONSIBILITY

We at Connectwell understand that the earth with its limited resources needs to be protected from environmental damage. Every positive action, no matter how small adds up to great things.

We endeavour to create products which are RoHS & REACH compliant. We are currently working on getting environmental certification for our entire organization.

We have constantly endeavoured to use technology to reduce our consumption of resources. Our plant and equipment are all upgraded constantly to reduce consumption of water and electricity.

We at Connectwell support various NGOs and Self-Help groups as a part of giving back to our communities. Some of them are listed below

Astitva Trust

School for differently abled children

Bharari Asthiviyand Viklang Sanstha

Home for people disabled by age and sickness

Adhar

Lifetime Shelter for the mentally handicapped

Triumph Foundation & Comprehensive Thalassemia Care PHO and BMT

Blood transfusions for thalassemia affected

Karuna Sharan Welfare

Home for destitute boys from juvenile custody

Bombay YMCA

Night study center and computer institute for economically backward section of the society.







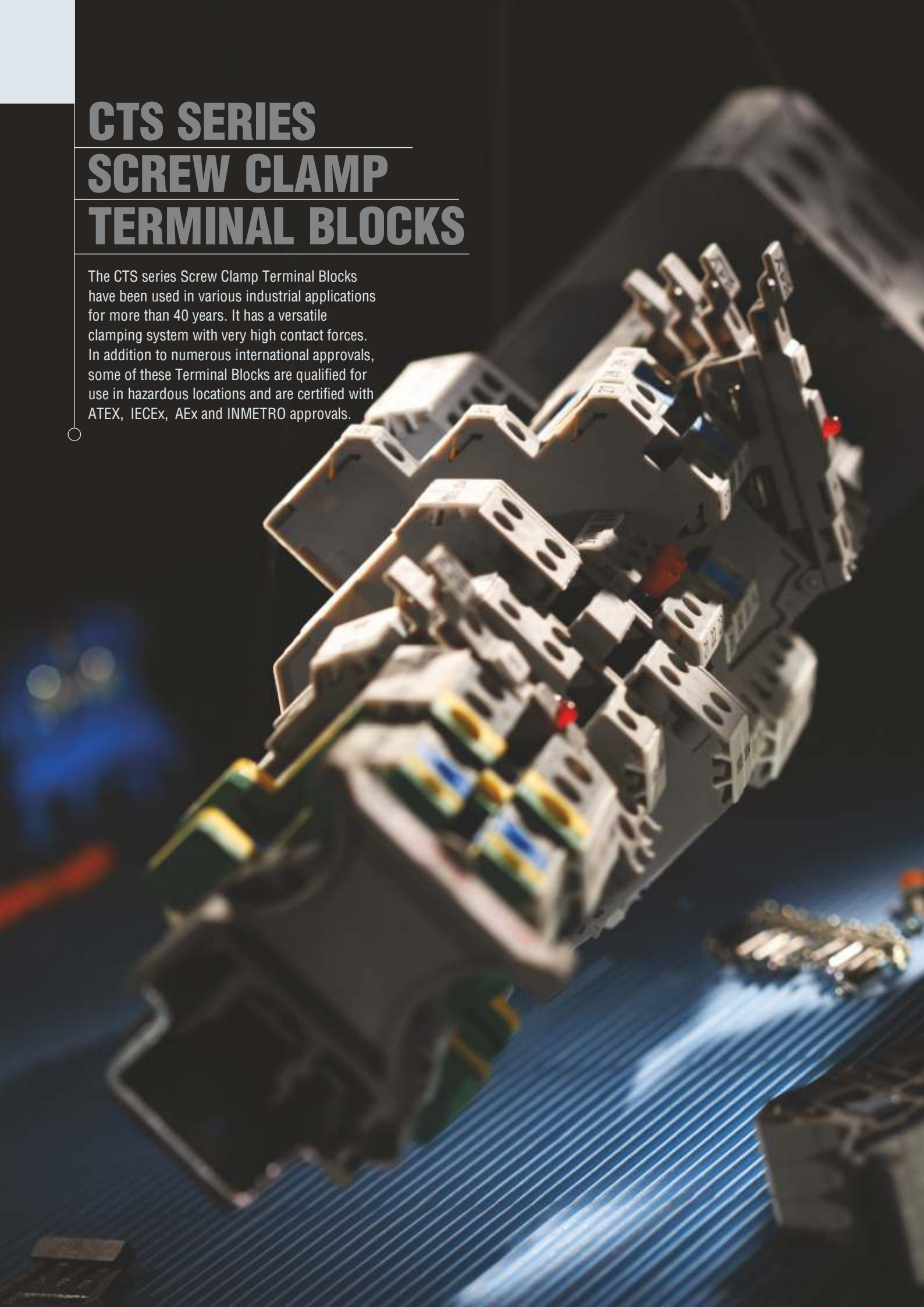











CTS SERIES SCREW CLAMP TERMINAL BLOCKS

The CTS series Screw Clamp Terminal Blocks have been used in various industrial applications for more than 40 years. It has a versatile clamping system with very high contact forces. In addition to numerous international approvals, some of these Terminal Blocks are qualified for use in hazardous locations and are certified with ATEX, IECEx, AEx and INMETRO approvals.



CTS SERIES SCREW CLAMP TERMINAL BLOCKS

	Standard Feed Through	9 - 14
	Multiple Connection	15 - 16
	Multiple Level	17 - 24
	Ground / Earth	25 - 28
	Neutral / Earth Clamps	29 - 30
	Screw & Spring Type Shield Connection Clamps	31 - 32
	Fuse Terminal	33 - 34
	Double Level Fuse	35 - 36
	Disconnect & Test	37 - 48
	Distribution Blocks	48 - 52
	Compact Distribution Blocks	53 - 55
	Component Carrier	56
	High Voltage	57 - 58
	Spring Loaded	59 - 62
	Micro & Panel Mount	63 - 64
	Thermocouple & Tab Connection	65 - 66
	With Electronic Components	67 - 72



A high torque clamping system on the Screw Clamp Terminal Blocks ensures safe, gas tight connections. Cold forged, rolled threaded screws ensure highly reliable connections.

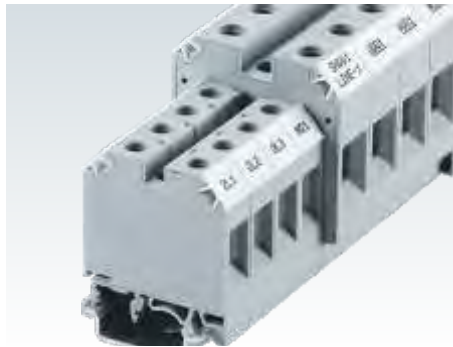

All Terminal Blocks for connecting 16mm² wires and above have a built-in integral end plate thereby covering all live parts. This ensures safe isolation for power connections.



Same profile grounding terminals are clearly identified with a green-yellow housing. Their shape and thickness is identical to the respective feed through terminal of same wire size.



In high current Terminal Blocks, an additional auxiliary terminal can be connected. This enables an additional connection of upto 6 mm² wires.



Multiple connection Terminal Blocks enable secure connection of more than one wire in a single Terminal Block.



Two level plus ground and Three level plus ground terminals facilitate single & three phase connections. These Terminal Blocks are an ideal choice for three phase and three phase plus ground circuits.



Universal voltage rating of 6 - 60V & 110 - 240V is available on Fuse Terminal Blocks with offline indication. Both AC & DC circuits can be connected without any polarisation requirement.



CDS6U Terminal Block system is a versatile wire connection method for current & voltage transformer and power meters. A wide range of accessories eases the testing of connected instruments.

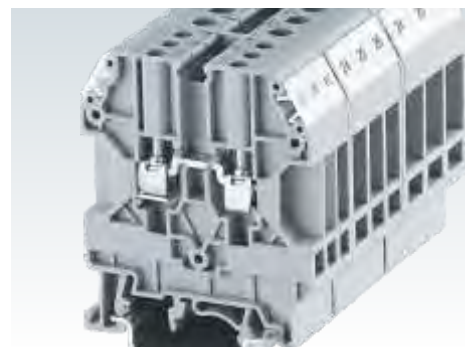

The CHV series High Voltage Terminal Blocks are suitable for upto 1500V DC applications required in the solar industry. The specially designed creepage and clearance distances help achieve the high voltage specifications.



CDB & CMDDB series distribution blocks are an ideal choice for power and signal distribution applications. They have an IP20 rating and no additional shrouds are required.



Miniature Terminal Blocks are an ideal choice for compact junction box applications. These Terminal Blocks can be mounted on DIN 15 rails.

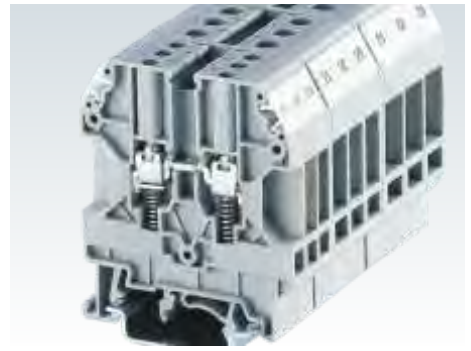

Spring Loaded Terminal Blocks are designed as per ESI standards and meet CEGB, SEC and NTPC guidelines.

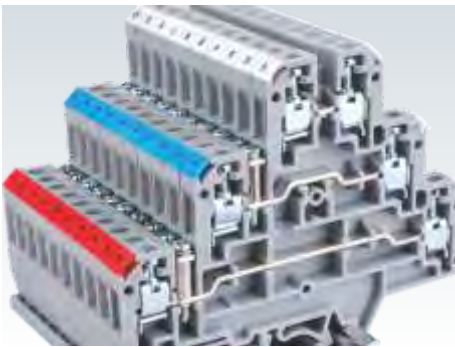

CTL series Terminal Blocks can be used for connecting sensors and actuators in control systems. Standard screw type jumpers are used to create configurations for ease of voltage distribution.



Panel mounted Terminal Blocks eliminate the need for using DIN rails. Individual terminals can be 'clicked' into each other to create specific pole configurations as per user requirements.

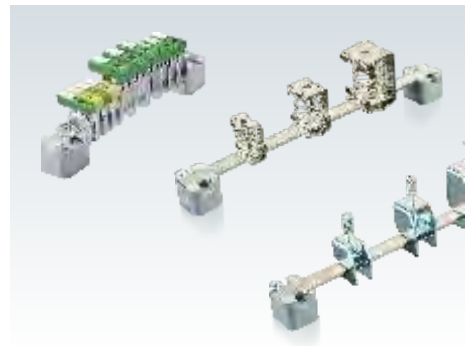

Shield connection clamps facilitate EMC continuity of shielded cables. Neutral & Earth clamps provides flexible solutions for terminating neutral & earthing wires on bus bars.



CTT series Terminal Blocks are used to terminate thermocouple wires. Different variants are available to connect 'K', 'J', 'T' and 'E' type thermocouple wires.

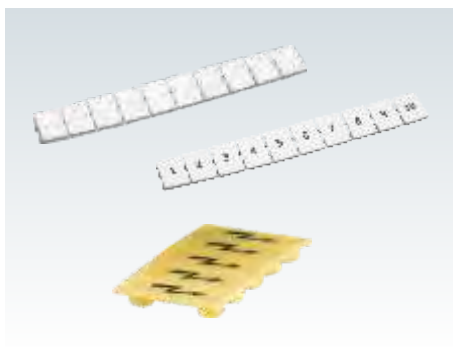

Standardized marking solutions are available to create clear and user friendly Terminal Block assemblies. Users can order blank or custom configured marking tags.















A wide range of functional Terminal Blocks are available with built in electronic components.

STANDARD FEED THROUGH TERMINAL BLOCKS

These Feed Through Terminal Blocks are the most versatile terminals for Control, Automation, Instrumentation and Power Distribution applications. A specially designed flexible foot enables easy mounting and dismounting from the DIN rail with the help of a screw driver. These Terminal Blocks have marker holding recesses to accept marking tags for circuit identification. Cross connection can be achieved with the aid of screw type jumpers.

The terminals with  & IECEx approval can be used in potentially explosive atmosphere. For detailed information refer page 243.

Width (Thickness) x Length		5 x 43 mm				
Height with DIN 35 x 7.5 / 35 x 15 / 32 mm Rail		46.2 mm / 53.7 mm / 51.1 mm				
Connection Possibility as per		IEC		UL - CSA		
With 1 Conductor per clamp	Stranded / Flexible	0.2 - 2.5 mm ²	22 - 12 AWG			
	Solid	0.2 - 4.0 mm ²	22 - 10 AWG			
	with Ferrule / Lug	0.2 - 2.5 mm ²	22 - 12 AWG			
With 2 same size Conductors per clamp	Stranded / Flexible	0.2 - 2.5 mm ²	22 - 16 AWG			
	with TWIN Ferrule / Lug	0.2 - 1.5 mm ²	22 - 16 AWG			
Wire Stripping Length		8 mm				
Ratings As Per		IEC60947-7-1	UL-1059	CSA22.2-158	IEC 60079-7	
Voltage		1000 V	600 V	600 V	690 V	
Current		24 A	25 A	25 A	21 A	
Torque		0.4 Nm	7 lb-in	7 lb-in	0.4 Nm	
Approvals						
Insulation Material / Material Group		Polyamide 6,6 / 1				
Rated Impulse Voltage / Pollution Degree		8 KV / 3				
		Type / Cat. No.		Standard Pack		
Terminal Block	Grey	CTS2.5UN		100		
	Blue	CTS2.5UNBU		100		
	Red	CTS2.5UNR		100		
	Yellow	CTS2.5UNY		100		
	Black	CTS2.5UNBK		100		
	Green	CTS2.5UNGN		100		
	Orange	CTS2.5UNO		100		
	White	CTS2.5UNW		100		
	Ground / Earth (Refer Pg. 25-26 for Details)		CGT4N		50	
	End Plate		EP2.5/4UN		50	
Partition Plate		PP2.5/4UN		50		
Separator Plate		SP2.5/4UN		100		
Mounting Rail (Refer Pg. 217 for details)		CA701-1M / CA701-1M-S		50 m		
		CA701-15-1M / CA701-15-1M-S		25 m		
End Clamp (Refer Pg. 218 for details)		CA702 / CA802		50		
Marking Tags (Refer Pg. 222 for details)		CA509/K5WHT		100		
Screw Driver		SCS0.5/3	Blade size: 0.5 x 3.0 mm	10		

Jumpers		Uninsulated	Insulated	Imax	Standard Pack
Screw Type Jumpers	2 pole	CA721/2	CA741/2	24 A	100
	3 pole	CA721/3	CA741/3	24 A	100
	4 pole	CA721/4	CA741/4	24 A	100
	10 pole	CA721/10	CA741/10	24 A	10
	100 pole	CA721/100	CA741/100	24 A	10
	Configurable Jumper Bar	2 pole	CA703/01		24 A
3 pole		CA704/01		24 A	100
4 pole		CA705/01		24 A	100
10 pole		CA731/10		24 A	100
10 pole (Breakable)					
100 pole		CA731/100		24 A	10
Short Sleeve & Screw for configurable jumper bar		CA707/S/Q/01		100	
Switchable Jumpers		CA706/01		24 A	100
Long Sleeve & Screw for Switchable Jumpers		CA707/L/Q/01		100	
External Jumpers	2 pole		CA717/2	24 A	100
	3 pole		CA717/3	24 A	100
	4 pole		CA717/4	24 A	100
	10 pole		CA717/10	24 A	20
Test Socket		CA707/TS/01		100	



CTS2.5UE



6 x 43 mm
46.2 mm / 53.7 mm / 51.1 mm

IEC	UL - CSA
0.2 - 4.0 mm ²	22 - 10 AWG
0.2 - 6.0 mm ²	
0.2 - 4.0 mm ²	22 - 10 AWG
0.2 - 2.5 mm ²	22 - 12 AWG
0.2 - 2.5 mm ²	22 - 12 AWG

8 mm
IEC60947-7-1 UL-1059 CSA22.2-158 IEC 60079-7

1000 V	600 V	600 V	690 V
30 A	35 A	30 A	28 A
0.5 Nm	7 lb-in	7 lb-in	0.4 Nm



Polyamide 6,6 / 1

8 KV / 3

Type / Cat. No.	Standard Pack
CTS2.5UE	100
CTS2.5UEBU	100
CTS2.5UER	100
CTS2.5UEY	100
CTS2.5UEBK	100
CTS2.5UEGN	100
CTS2.5UEO	100
CTS2.5UEW	100
CGT4N	50
EP2.5/4UN	50
PP2.5/4UN	50
SP2.5/4UN	100
CA701-1M / CA701-1M-S	50 m
CA701-15-1M / CA701-15-1M-S	25 m
CA702 / CA802	50
CA509/K6WHT	100
SCS0.6/3.5 Blade size: 0.6 x 3.5 mm	10

CTS4UN



6 x 43 mm
46.2 mm / 53.7 mm / 51.1 mm

IEC	UL - CSA
0.2 - 4.0 mm ²	22 - 10 AWG
0.2 - 6.0 mm ²	
0.2 - 4.0 mm ²	22 - 10 AWG
0.2 - 2.5 mm ²	22 - 12 AWG
0.2 - 2.5 mm ²	22 - 12 AWG

8 mm
IEC60947-7-1 UL-1059 CSA22.2-158 IEC 60079-7

1000 V	600 V	600 V	690 V
32 A	35 A	35 A	28 A
0.5 Nm	7 lb-in	7 lb-in	0.5 Nm



Polyamide 6,6 / 1

8 KV / 3

Type / Cat. No.	Standard Pack
CTS4UN	100
CTS4UNBU	100
CTS4UNR	100
CTS4UNY	100
CTS4UNBK	100
CTS4UNGN	100
CTS4UNO	100
CTS4UNW	100
CGT4N	50
EP2.5/4UN	50
PP2.5/4UN	50
SP2.5/4UN	100
CA701-1M / CA701-1M-S	50 m
CA701-15-1M / CA701-15-1M-S	25 m
CA702 / CA802	50
CA509/K6WHT	100
SCS0.6/3.5 Blade size: 0.6 x 3.5 mm	10

CTS6U

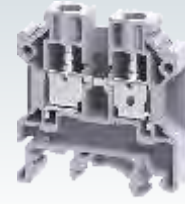

8 x 43 mm
47.8 mm / 55.5 mm / 52.8 mm

IEC	UL - CSA
0.5 - 6.0 mm ²	22 - 8 AWG
0.5 - 6.0 mm ²	
0.5 - 6.0 mm ²	22 - 8 AWG
0.5 - 4.0 mm ²	22 - 10 AWG
0.5 - 4.0 mm ²	22 - 10 AWG

9 mm
IEC60947-7-1 UL-1059 CSA22.2-158 IEC 60079-7

1000 V	600 V	600 V	690 V
41 A	50 A	50 A	36 A
0.8 Nm	14 lb-in	14 lb-in	0.8 Nm



Polyamide 6,6 / 1

8 KV / 3

Type / Cat. No.	Standard Pack
CTS6U	100
CTS6UBU	100
CTS6UR	100
CTS6UY	100
CTS6UBK	100
CTS6UGN	100
CTS6UO	100
CTS6UW	100
CGT6N	50
EP6/10U	50
PP6/10U	50
SP6/10U	100
CA701-1M / CA701-1M-S	50 m
CA701-15-1M / CA701-15-1M-S	25 m
CA702 / CA802	50
CA509/K8WHT	100
SCS0.8/4 Blade size: 0.8 x 4 mm	10

Uninsulated	Insulated	Imax	Standard Pack
CA722/2	CA742/2	32 A	100
CA722/3	CA742/3	32 A	100
CA722/4	CA742/4	32 A	100
CA722/10	CA742/10	32 A	10
CA722/100	CA742/100	32 A	10
CA703/1		32 A	100
CA704/1		32 A	100
CA705/1		32 A	100
CA732/10		32 A	100
CA732/10-A		32 A	100
CA732/100		32 A	10
CA707/S/Q/01			100
CA706/1		32A	100
CA707/L/Q/01			100
	CA713/2	30 A	100
	CA713/3	30 A	100
	CA713/4	30 A	100
	CA713/10	30 A	20
CA707/TS/01			100

Uninsulated	Insulated	Imax	Standard Pack
CA722/2	CA742/2	32 A	100
CA722/3	CA742/3	32 A	100
CA722/4	CA742/4	32 A	100
CA722/10	CA742/10	32 A	10
CA722/100	CA742/100	32 A	10
CA703/1		32 A	100
CA704/1		32 A	100
CA705/1		32 A	100
CA732/10		32 A	100
CA732/10-A		32 A	100
CA732/100		32 A	10
CA707/S/Q/01			100
CA706/1		32A	100
CA707/L/Q/01			100
	CA713/2	30 A	100
	CA713/3	30 A	100
	CA713/4	30 A	100
	CA713/10	30 A	20
CA707/TS/01			100

Uninsulated	Insulated	Imax	Standard Pack
CA723/2	CA743/2	41 A	100
CA723/3	CA743/3	41 A	50
CA723/4	CA743/4	41 A	50
CA723/10	CA743/10	41 A	10
CA703/2		41 A	100
CA704/2		41 A	100
CA705/2		41 A	100
CA733/10		41 A	100
CA707/S/Q/1			100
CA706/2		41A	100
CA707/L/Q/1			100
	CA710/2	35 A	100
	CA710/3	35 A	50
	CA710/4	35 A	50
	CA710/10	35 A	20
CA707/TS/05			100

STANDARD FEED THROUGH TERMINAL BLOCKS

CTS10U



CTS16U



Width (Thickness) x Length	10 x 43 mm
----------------------------	------------

Height with DIN 35 x 7.5 / 35 x 15 / 32 mm Rail	47.8 mm / 55.5 mm / 52.8 mm
---	-----------------------------

Connection Possibility as per	IEC	UL - CSA
-------------------------------	-----	----------

With 1 Conductor per clamp	Stranded / Flexible	0.5 - 10.0 mm ²	16 - 6 AWG
	Solid with Ferrule / Lug	0.5 - 10.0 mm ²	16 - 6 AWG

With 2 same size Conductors per clamp	Stranded / Flexible	0.5 - 6.0 mm ²	16 - 10 AWG
	with TWIN Ferrule / Lug	0.5 - 6.0 mm ²	16 - 10 AWG

Wire Stripping Length	11 mm
-----------------------	-------

Ratings As Per	IEC60947-7-1	UL-1059	CSA22.2-158	IEC 60079-7
----------------	--------------	---------	-------------	-------------

Voltage	1000 V	600 V	600 V	690 V
---------	--------	-------	-------	-------

Current	57 A	65 A	65 A	50 A
---------	------	------	------	------

Torque	1.2 Nm	14 lb-in	14 lb-in	1.2 Nm
--------	--------	----------	----------	--------

Approvals	
-----------	--

Insulation Material / Material Group	Polyamide 6,6 / 1
--------------------------------------	-------------------

Rated Impulse Voltage / Pollution Degree	8 KV / 3
--	----------

Width (Thickness) x Length	12 x 43 mm
----------------------------	------------

Height with DIN 35 x 7.5 / 35 x 15 / 32 mm Rail	47.8 mm / 55.5 mm / 52.8 mm
---	-----------------------------

Connection Possibility as per	IEC	UL - CSA
-------------------------------	-----	----------

With 1 Conductor per clamp	Stranded / Flexible	0.2 - 16.0 mm ²	20 - 4 AWG
	Solid with Ferrule / Lug	0.2 - 16.0 mm ²	20 - 4 AWG

With 2 same size Conductors per clamp	Stranded / Flexible	0.2 - 10.0 mm ²	20 - 8 AWG
	with TWIN Ferrule / Lug	0.2 - 10.0 mm ²	20 - 8 AWG

Wire Stripping Length	12 mm
-----------------------	-------

Ratings As Per	IEC60947-7-1	UL-1059	CSA22.2-158	IEC 60079-7
----------------	--------------	---------	-------------	-------------

Voltage	1000 V	600 V	600 V	690 V
---------	--------	-------	-------	-------

Current	76 A	85 A	70 A	66 A
---------	------	------	------	------

Torque	1.2 Nm	14 lb-in	14 lb-in	2.0 Nm
--------	--------	----------	----------	--------

Approvals	
-----------	--

Insulation Material / Material Group	Polyamide 6,6 / 1
--------------------------------------	-------------------

Rated Impulse Voltage / Pollution Degree	8 KV / 3
--	----------

	Type / Cat. No.	Standard Pack
Terminal Block	Grey	CTS10U 100
	Blue	CTS10UBU 100
	Red	CTS10UR 100
	Yellow	CTS10UY 100
	Black	CTS10UBK 100
	Green	CTS10UGN 100
	Orange	CTS10UO 100
	White	CTS10UW 100
	Ground / Earth (Refer Pg. 26 - 28 for Details)	CGT10N 50
	End Plate	EP6/10U 50
Partition Plate	PP6/10U 50	
Separator Plate	SP6/10U 100	
Mounting Rail (Refer Pg. 217 for details)	CA701-1M / CA701-1M-S	50 m
	CA701-15-1M / CA701-15-1M-S	25 m
End Clamp (Refer Pg. 218 for details)	CA702 / CA802	50
Marking Tags (Refer Pg. 222 for details)	CA509/K10WHT	100
Screw Driver	SCS0.8/4 Blade size: 0.8 x 4 mm	10

	Type / Cat. No.	Standard Pack
Terminal Block	CTS16U 50	
	CTS16UBU 50	
	CTS16UR 50	
	CTS16UY 50	
	CTS16UBK 50	
	CTS16UGN 50	
	Ground / Earth (Refer Pg. 26 - 28 for Details)	CGT16N 50
	End Plate	EP6/16U 50
Partition Plate	PP6/16U 50	
Separator Plate	SP6/16U 100	
Mounting Rail (Refer Pg. 217 for details)	CA701-1M / CA701-1M-S	50 m
	CA701-15-1M / CA701-15-1M-S	25 m
End Clamp (Refer Pg. 218 for details)	CA702 / CA802	50
Marking Tags (Refer Pg. 222 for details)	CA509/K12WHT	100
Screw Driver	SCS1.0/5.5 Blade size: 1.0 x 5.5 mm	10

Jumpers

	Uninsulated	Insulated	Imax	Standard Pack	
Screw Type Jumpers	2 pole	CA724/2	CA744/2	57 A	100
	3 pole	CA724/3	CA744/3	57 A	50
	4 pole	CA724/4	CA744/4	57 A	50
	10 pole	CA724/10	CA744/10	57 A	10

Jumpers

	Uninsulated	Insulated	Imax	Standard Pack	
Screw Type Jumpers	2 pole	CA751/2	CA761/2	65 A	50
	3 pole	CA751/3	CA761/3	65 A	50
	4 pole	CA751/4	CA761/4	65 A	50
	10 pole	CA751/10	CA761/10	65 A	10

	Uninsulated	Insulated	Imax	Standard Pack
Configurable Jumper Bar	2 pole	CA703/3	57 A	100
	3 pole	CA704/3	57 A	100
	4 pole	CA705/3	57 A	100
	10 pole	CA734/10	57 A	100

	Uninsulated	Insulated	Imax	Standard Pack
Configurable Jumper Bar	2 pole	CA703/8	65 A	100
	3 pole	CA704/8	65 A	100
	4 pole	CA705/8	65 A	100
	10 pole	CA739/10	65 A	100

Short Sleeve & Screw for configurable jumper bar	CA707/S/Q/1	100
--	-------------	-----

Short Sleeve & Screw for configurable jumper bar	CA707/S/Q/1	100
--	-------------	-----

Switchable Jumpers	CA706/3	57 A	100
--------------------	---------	------	-----

Switchable Jumpers	CA706/3	57 A	100
--------------------	---------	------	-----

Long Sleeve & Screw for Switchable Jumpers	CA707/L/Q/1	100
--	-------------	-----

Long Sleeve & Screw for Switchable Jumpers	CA707/L/Q/1	100
--	-------------	-----

	Uninsulated	Insulated	Imax	Standard Pack
External Jumpers	2 pole	CA718/2	57 A	100
	3 pole	CA718/3	57 A	50
	4 pole	CA718/4	57 A	50
	10 pole	CA718/10	57 A	20

	Uninsulated	Insulated	Imax	Standard Pack
External Jumpers	2 pole	CA719/2	76 A	20
	3 pole	CA719/3	76 A	20
	4 pole	CA719/4	76 A	20
	10 pole	CA719/10	76 A	20

Test Socket	CA707/TS/05	100
-------------	-------------	-----

Test Socket	CA707/TS/05	100
-------------	-------------	-----

CTS25UN



12 x 48 mm
57.2 mm / 64.7 mm / 62.3 mm

IEC	UL - CSA
4.0 - 25.0 mm ²	14 - 2 AWG
4.0 - 25.0 mm ²	14 - 2 AWG
4.0 - 16 mm ²	14 - 4 AWG
4.0 - 10 mm ²	14 - 6 AWG

14 mm

IEC60947-7-1 UL-1059 CSA22.2-158 IEC 60079-7

1000 V	600 V	600 V	690 V
101 A	105 A	85 A	88 A
2.0 Nm	30 lb-in	18 lb-in	2.0 Nm



Polyamide 6,6 / 1

8 KV / 3

Type / Cat. No.	Standard Pack
CTS25UN	50
CTS25UNBU	50
CTS25UNNR	50
CTS25UNY	50
CTS25UNBK	50
CTS25UNGN	50

CTS35UN



16 x 50.5 mm
59.2 mm / 66.7 mm / 64.3 mm

IEC	UL - CSA
4.0 - 35.0 mm ²	12 - 1/0 AWG
4.0 - 35.0 mm ²	12 - 1/0 AWG
4.0 - 16.0 mm ²	12 - 4 AWG
4.0 - 16.0 mm ²	12 - 8 AWG

15 mm

IEC60947-7-1 UL-1059 CSA22.2-158 IEC 60079-7

1000 V	600 V	600 V	800 V
125 A	150 A	130 A	109 A
2.5 Nm	50 lb-in	25 lb-in	2.5 Nm



Polyamide 6,6 / 1

8 KV / 3

Type / Cat. No.	Standard Pack
CTS35UN	50
CTS35UNBU	50
CTS35UNNR	50
CTS35UNY	50
CTS35UNBK	50
CTS35UNGN	50

CGT35U 20

PP35UN 50

CA701-1M / CA701-1M-S 50 m
CA701-15-1M / CA701-15-1M-S 25 m

CA702 / CA802 50

CA509/K16WHT 100

SCS1.0/5.5 Blade size: 1.0 x 5.5 mm 10

Uninsulated	Insulated	I _{max}	Standard Pack
CA725/2	CA745/2	90 A	50
CA725/3	CA745/3	90 A	20
CA725/4	CA745/4	90 A	20
CA725/10	CA745/10	90 A	10

CA703/4		90 A	100
CA704/4		90 A	100
CA705/4		90 A	100
CA735/10		90 A	100

CA707/S/Q/2 100

CA707/TS/06 100

CTS35UNA

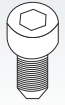

With Allen screw



16 x 50.5 mm
59.2 mm / 66.7 mm / 64.3 mm

IEC	UL - CSA
4.0 - 35.0 mm ²	12 - 2 AWG
4.0 - 35.0 mm ²	12 - 2 AWG
4.0 - 16.0 mm ²	12 - 4 AWG
4.0 - 16.0 mm ²	12 - 8 AWG

15 mm

IEC60947-7-1 UL-1059 CSA22.2-158

1000 V	600 V	600 V	
125 A	150 A	130 A	
2.5 Nm	50 lb-in	25 lb-in	



Polyamide 6,6 / 1

8 KV / 3

Type / Cat. No.	Standard Pack
CTS35UNA	50
CTS35UNABU	50
CTS35UNAR	50
CTS35UNAY	50
CTS35UNABK	50
CTS35UNAGN	50

CGT35U 20

PP35UN 50

CA701-1M / CA701-1M-S 50 m
CA701-15-1M / CA701-15-1M-S 25 m

CA702 / CA802 50

CA509/K16WHT 100

SCS1.0/5.5 Blade size: 1.0 x 5.5 mm 10

Uninsulated	Insulated	I _{max}	Standard Pack
CA771/2	CA781/2	105 A	50
CA771/3	CA781/3	105 A	20
CA771/4	CA781/4	105 A	20
CA771/10	CA781/10	105 A	10

CA703/10		105 A	100
CA704/10		105 A	100
CA705/10		105 A	100
CA770/10		105 A	10

CA707/S/Q/2 100

CA707/TS/06 100

STANDARD FEED THROUGH TERMINAL BLOCKS

CTS50/70N



CTS50/70NA

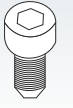

With Allen screw

Width (Thickness) x Length	20.5 x 77 mm			20.5 x 77 mm			
Height with DIN 35 x 7.5 / 35 x 15 / 32 mm Rail	71.1 mm / 78.1 mm			71.1 mm / 78.1 mm			
Connection Possibility as per	Stranded / Flexible with Ferrule / Lug	IEC	UL - CSA		IEC	UL - CSA	
		10.0 - 70.0 mm ²	8 - 2/0 AWG		10.0 - 70.0 mm ²	8 - 2/0 AWG	
With 2 same size Conductors per clamp	Stranded / Flexible	10.0 - 35.0 mm ²	8 - 2 AWG		10.0 - 35.0 mm ²	8 - 2 AWG	
Wire Stripping Length	22 mm			22 mm			
Ratings As Per	IEC60947-7-1	UL-1059	CSA22.2-158	IEC60947-7-1	UL-1059	CSA22.2-158	
Voltage	1000 V	1000 V	1000 V	1000 V	1000 V	1000 V	
Current	192 A	175 A	175 A	192 A	175 A	175 A	
Torque	3.0 Nm	38 lb-in	38 lb-in	3.0 Nm	38 lb-in	38 lb-in	
Approvals							
Insulation Material / Material Group	Polyamide 6,6 / 1			Polyamide 6,6 / 1			
Rated Impulse Voltage / Pollution Degree	8 KV / 3			8 KV / 3			

		Type / Cat. No.	Standard Pack			Type / Cat. No.	Standard Pack
Terminal Block	Grey	CTS50/70N	20	CTS50/70NA	Grey	CTS50/70NA	20
	Blue	CTS50/70NBU	20		Blue	CTS50/70NABU	20
	Red	CTS50/70NR	20		Red	CTS50/70NAR	20
	Yellow	CTS50/70NY	20		Yellow	CTS50/70NAY	20
	Black	CTS50/70NBK	20		Black	CTS50/70NABK	20
	Green	CTS50/70NGN	20		Green	CTS50/70NAGN	20
	Green-Yellow	CGT50/70N	20		Green-Yellow	CGT50/70N	20
Auxiliary / Pick Off Terminal		AUX6	10	AUX6	10		
Mounting Rail (Refer Pg. 217 for details)		CA701-1M / CA701-1M-S	50 m	CA701-1M / CA701-1M-S	50 m		
		CA701-15-1M / CA701-15-1M-S	25 m	CA701-15-1M / CA701-15-1M-S	25 m		
End Clamp (Refer Pg. 218 for details)		CA202 / CA102	50	CA202 / CA102	50		
Marking Tags (Refer Pg. 222 for details)		CA509/K16WHT	100	CA509/K16WHT	100		

		Type / Cat. No.	Imax	Standard Pack			Type / Cat. No.	Imax	Standard Pack
Screw Type Jumpers		CA628/2	192 A	10	CA628/2	192 A	10		
		CA628/3	192 A	10		CA628/3	192 A	10	

CTS95/120N



With Allen screw

27 x 85 mm

83.0 mm / 90.5 mm

IEC	UL - CSA
25.0 - 120.0 mm ²	2 - 250 kcmil
25.0 - 120.0 mm ²	2 - 250 kcmil

25.0 - 70 mm ²	2 - 2/0 AWG
---------------------------	-------------

24 mm

IEC60947-7-1 UL-1059 CSA22.2-158

1000 V	1000 V	1000 V
269 A	240 A	240 A
6.0 Nm	90 lb-in	90 lb-in



Polyamide 6,6 / 1

8 KV / 3

Type / Cat. No.	Standard Pack
CTS95/120N	10
CTS95/120NBU	10
CTS95/120NR	10
CTS95/120NY	10
CTS95/120NBK	10
CTS95/120NGN	10

AUX6	10
CA701-1M / CA701-1M-S	50 m
CA701-15-1M / CA701-15-1M-S	25 m
CA202 / CA102	50
CA509/K16WHT	100

Type / Cat. No.	I _{max}	Standard Pack
CA629/2	269 A	10
CA629/3	269 A	10

AUX6 (Auxiliary Terminal Block)

In certain power circuits, there is a need to take an extra connection for an Auxiliary circuit like an indicating light or contactor. The AUX6 terminal easily plugs into the terminal and provides this extra connection point.

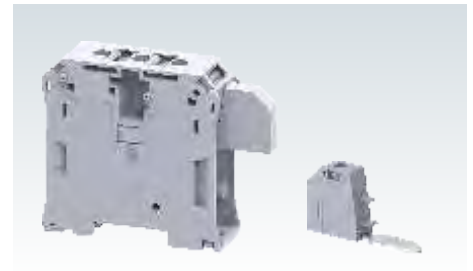

Width (Thickness) x Length x Height

With 1 Conductor per clamp	Stranded / Flexible Solid with Ferrule / Lug
With 2 same size Conductors per clamp	Stranded / Flexible with TWIN Ferrule / Lug

Ratings As Per

Voltage	1000 V
Current	41 A
Torque	0.8 Nm

8 x 53.6 x 29.4 mm

0.5 - 6.0 mm ²	22 - 8 AWG
0.5 - 6.0 mm ²	22 - 8 AWG
0.5 - 4.0 mm ²	22 - 10 AWG
0.5 - 4.0 mm ²	22 - 10 AWG

IEC60947-7-1 UL-1059 CSA22.2-158 IEC 60079-7

1000 V	600 V	600 V	630 V
41 A	50 A	50 A	36 A
0.8 Nm	14 lb-in	14 lb-in	0.8 Nm

Type / Cat. No.	Standard Pack	Suitable For
AUX6	10	CTS50/70N CTS50/70NA CTS95/120N
CA509/K8WHT	100	AUX6

Auxiliary Terminal

Marking Tag



MULTIPLE CONNECTION TERMINAL BLOCKS

These blocks are used to connect multiple wires in a single Terminal Block, thereby eliminating reliability problems encountered when connecting multiple wires in a single clamp.

CMCG4 ground terminal enables the connection of grounding wires and is available in standard Green-Yellow colour.





The terminals with  & IECEx approval can be used in potentially explosive atmosphere. For detailed information refer page 243.

CMC1-2







Width (Thickness) x Length		6 x 46.5 mm
Height with DIN 35 x 7.5 / 35 x 15 / 32 mm Rail		49.5 mm / 56.5 mm / 53.3 mm
Connection Possibility as per		
With 1 Conductor per clamp	Stranded / Flexible	0.2 - 4.0 mm ²
	Solid with Ferrule / Lug	0.2 - 6.0 mm ²
With 2 same size Conductors per clamp	Stranded / Flexible	0.2 - 4.0 mm ²
	with TWIN Ferrule / Lug	0.2 - 2.5 mm ²
Wire Stripping Length		9 mm
Ratings As Per		IEC60947-7-1 UL-1059 CSA22.2-158 IEC 60079-7
Voltage		630 V 600 V 600 V 500 V
Current		32 A 35 A 35 A 28 A
Torque		0.5 Nm 7 lb-in 7 lb-in 0.5 Nm
Approvals		
Insulation Material / Material Group		Polyamide 6,6 / 1
Rated Impulse Voltage / Pollution Degree		8 KV / 3

IEC		UL - CSA	
0.2 - 4.0 mm ²		22 - 10 AWG	
0.2 - 6.0 mm ²		22 - 10 AWG	
0.2 - 4.0 mm ²		22 - 10 AWG	
0.2 - 2.5 mm ²		22 - 12 AWG	
0.2 - 2.5 mm ²		22 - 12 AWG	

Terminal Block		Grey	Blue
Ground / Earth (Refer Pg. 16 for Details)			
End Plate			
Mounting Rail (Refer Pg. 217 for details)			
End Clamp (Refer Pg. 218 for details)			
Marking Tags (Refer Pg. 222 for details)			
Screw Driver			

Type / Cat. No.	Standard Pack
CMC1-2	100
CMC1-2BU	100
EPCMC1-2	50
CA701-1M / CA701-1M-S	50 m
CA701-15-1M / CA701-15-1M-S	25 m
CA702 / CA802	50
CA509/K6WHT	100
SCS0.6/3.5 Blade size: 0.6 x 3.5 mm	10

Jumpers		Uninsulated	Insulated	Imax	Standard Pack
Screw Type Jumpers	2 pole	CA722/2	CA742/2	32 A	100
	3 pole	CA722/3	CA742/3	32 A	100
	4 pole	CA722/4	CA742/4	32 A	100
	10 pole	CA722/10	CA742/10	32 A	10
	100 pole	CA722/100	CA742/100	32 A	10
Configurable Jumper Bar	2 pole	CA703/1		32 A	100
	3 pole	CA704/1		32 A	100
	4 pole	CA705/1		32 A	100
	10 pole	CA732/10		32 A	100
	10 pole (Breakable)	CA732/10-A		32 A	100
	100 pole	CA732/100		32 A	10
Short Sleeve & Screw for configurable jumper bar		CA707/S/Q/01			100
External Jumpers	2 pole	CA713/2		30 A	100
	3 pole	CA713/3		30 A	100
	4 pole	CA713/4		30 A	100
	10 pole	CA713/10		30 A	20
Test Socket		CA707/TS/01			100

Screw Type Jumpers					
Configurable Jumper Bar					
Short Sleeve & Screw for configurable jumper bar					
External Jumpers					
Test Socket					

* External Jumpers can be used only in the upper level clamping unit of the Terminal Block.

CMC2-2



6 x 65 mm
53.4 mm / 60.5 mm / 58.7 mm

IEC	UL - CSA
0.2 - 4.0 mm ²	22 - 10 AWG
0.2 - 6.0 mm ²	
0.2 - 4.0 mm ²	22 - 10 AWG
0.2 - 2.5 mm ²	22 - 12 AWG
0.2 - 2.5 mm ²	22 - 12 AWG

9 mm

IEC60947-7-1 UL-1059 CSA22.2-158 IEC 60079-7

630 V	600 V	600 V	690 V
32 A	35 A	35 A	28 A
0.5 Nm	7 lb-in	7 lb-in	0.5 Nm



Polyamide 6,6 / 1

8 KV / 3

Type / Cat. No.	Standard Pack
CMC2-2	50
CMC2-2BU	50
CMCG4	50
EPCMC2-2	50
CA701-1M / CA701-1M-S	50 m
CA701-15-1M / CA701-15-1M-S	25 m
CA702 / CA802	50
CA509/K6WHT	100
SCS0.6/3.5 Blade size: 0.6 x 3.5 mm	10

Uninsulated	Insulated	I _{max}	Standard Pack
CA722/2	CA742/2	32 A	100
CA722/3	CA742/3	32 A	100
CA722/4	CA742/4	32 A	100
CA722/10	CA742/10	32 A	10
CA722/100	CA742/100	32 A	10
CA703/1		32 A	100
CA704/1		32 A	100
CA705/1		32 A	100
CA732/10		32 A	100
CA732/10-A		32 A	100
CA732/100		32 A	10
CA707/S/Q/01			100
CA713/2		30 A	100
CA713/3		30 A	100
CA713/4		30 A	100
CA713/10		30 A	20
CA707/TS/01			100

CMCG4



6 x 65 mm
53.7 mm / 60.9 mm

IEC	UL - CSA
0.2 - 4.0 mm ²	24 - 10 AWG
0.2 - 6.0 mm ²	
0.2 - 4.0 mm ²	24 - 10 AWG
0.2 - 2.5 mm ²	24 - 12 AWG
0.2 - 2.5 mm ²	24 - 12 AWG

9 mm

IEC60947-7-2 UL-1059 CSA22.2-158

630 V	600 V	600 V	690 V
32 A	35 A	35 A	28 A
0.5 Nm	4.5 lb-in	4.5 lb-in	0.5 Nm



Polyamide 6,6 / 1

8 KV / 3

Type / Cat. No.	Standard Pack
CMCG4	50
EPCKT4U/4	50
CA701-1M / CA701-1M-S	50 m
CA701-15-1M / CA701-15-1M-S	25 m
CA702 / CA802	50
CA509/K6WHT	100
SCS0.6/3.5 Blade size: 0.6 x 3.5 mm	10

Uninsulated	Insulated	I _{max}	Standard Pack

MULTIPLE LEVEL TERMINAL BLOCKS

These Terminal Blocks are ideal for use in applications requiring high density wiring. In the ODL series Terminal Blocks, the top level is offset from the bottom level by half the thickness of the Terminal Block. In ODL2.5A, ODL4UA the terminals can be interlocked.

In the ODL2.5(I.S) & CDL4UN(I.S) Terminal Blocks, both levels are internally shorted.

The ODLG2.5 & CDLG4 Terminal Block have a feed through functions in the top level and grounding function on the bottom level. These grounding points are appropriately identified by the green-yellow imprint. ODLG2.5(I.S) and CDLG4(I.S) are grounding Terminal Blocks with the same profile of ODL2.5 and CDL4UN Terminal Blocks respectively.

Triple level Terminal Blocks are an ideal choice for control systems where sensor and actuator applications are involved. The simplified 3-level connections tremendously increase wiring density in the circuit.

The top level of the CTL2.5UH Terminal Block provides connection points for signal wires while the middle and bottom level are used for positive and negative potentials. In applications where switching indication is required choice of CTL2.5UL & CTL2.5UHL with built in electronic components is available.

Marking tags in blue and red colour besides the conventional white colour are suggested for effective identification. CTL2.5U(I.S) is internally shorted and CTL2.5UH(I.S)D2 is internally shorted with built in Diode for reverse polarity protection.

CTLG2.5 is a triple level Terminal Block with an additional connection point for earthing cables.

Width (Thickness) x Length	5 x 62 mm			
Height with DIN 35 x 7.5 / 35 x 15	61 mm / 68.5 mm			
Connection Possibility as per	IEC		UL - CSA	
With 1 Conductor per clamp	Stranded / Flexible	0.2 - 2.5 mm ²	24 - 12 AWG	
	Solid with Ferrule / Lug	0.2 - 4.0 mm ²	24 - 12 AWG	
With 2 same size Conductors per clamp	Stranded / Flexible	0.2 - 2.5 mm ²	24 - 16 AWG	
	with TWIN Ferrule / Lug	0.2 - 1.5 mm ²	24 - 16 AWG	
Wire Stripping Length	8 mm			
Ratings As Per	IEC60947-7-1	UL-1059	CSA22.2-158	
Voltage	800 V	300 V	300 V	
Current	24 A	25 A	25 A	
Torque	0.4 Nm	4.5 lb-in	4.5 lb-in	
Approvals				
Insulation Material / Material Group	Polyamide 6,6 / 1			
Rated Impulse Voltage / Pollution Degree	8 KV / 3			



Terminal Block	With Stackable Function	
End Plate		Front Side Back Side
Mounting Rail	(Refer Pg. 217 for details)	
End Clamp	(Refer Pg. 218 for details)	
Marking Tags	(Refer Pg. 222 for details)	
Screw Driver		

Type / Cat. No.	Standard Pack
ODL2.5A	50
ODL2.5	50
EPODL2.5	50
EP1ODL2.5	50
CA701-1M / CA701-1M-S	50 m
CA701-15-1M / CA701-15-1M-S	25 m
CA702 / CA802 / CA202	50
CA509/K5WHT	100
SCS0.5/3	Blade size: 0.5 x 3.0 mm / 10

Jumpers	Type / Cat. No.	I _{max}	Standard Pack
Pluggable Jumpers 	2 pole	JX2.5/2	24 A / 100
	3 pole	JX2.5/3	24 A / 50
	4 pole	JX2.5/4	24 A / 50
	5 pole	JX2.5/5	24 A / 50
	6 pole	JX2.5/6	24 A / 10
	7 pole	JX2.5/7	24 A / 10
	8 pole	JX2.5/8	24 A / 10
	10 pole	JX2.5/10	24 A / 10
	Test Plug	TX2.5	50

Type / Cat. No.	I _{max}	Standard Pack
JX2.5/2	24 A	100
JX2.5/3	24 A	50
JX2.5/4	24 A	50
JX2.5/5	24 A	50
JX2.5/6	24 A	10
JX2.5/7	24 A	10
JX2.5/8	24 A	10
JX2.5/10	24 A	10
TX2.5		50

ODL2.5A(I.S)



5 x 62 mm

61 mm / 68.5 mm

IEC	UL - CSA
0.2 - 2.5 mm ²	24 - 12 AWG
0.2 - 4.0 mm ²	
0.2 - 2.5 mm ²	24 - 12 AWG
0.2 - 1.5 mm ²	24 - 16 AWG
0.2 - 1.5 mm ²	24 - 16 AWG

8 mm

IEC60947-7-1 UL-1059 CSA22.2-158

800 V	300 V	300 V
24 A	25 A	25 A

0.4 Nm	4.5 lb-in	4.5 lb-in



Polyamide 6,6 / 1

8 KV / 3

Type / Cat. No.	Standard Pack
ODL2.5A(I.S)	50
ODL2.5(I.S)	50
EPODL2.5	50
EP1ODL2.5	50
CA701-1M / CA701-1M-S	50 m
CA701-15-1M / CA701-15-1M-S	25 m
CA702 / CA802 / CA202	50
CA509/K5WHT	100
SCS0.5/3 Blade size: 0.5 x 3.0 mm	10

Type / Cat. No.	I _{max}	Standard Pack
JX2.5/2	24 A	100
JX2.5/3	24 A	50
JX2.5/4	24 A	50
JX2.5/5	24 A	50
JX2.5/6	24 A	10
JX2.5/7	24 A	10
JX2.5/8	24 A	10
JX2.5/10	24 A	10
TX2.5		50

ODLG2.5A



5 x 62 mm

61 mm / 68.5 mm

IEC	UL - CSA
0.2 - 2.5 mm ²	24 - 12 AWG
0.2 - 4.0 mm ²	
0.2 - 2.5 mm ²	24 - 12 AWG
0.2 - 1.5 mm ²	24 - 16 AWG
0.2 - 1.5 mm ²	24 - 16 AWG

8 mm

IEC60947-7-1 UL-1059 CSA22.2-158

800 V	300 V	300 V
24 A	25 A	25 A

0.4 Nm	4.5 lb-in	4.5 lb-in



Polyamide 6,6 / 1

8 KV / 3

Type / Cat. No.	Standard Pack
ODLG2.5A	50
ODLG2.5	50
EPODL2.5	50
EP1ODL2.5	50
CA701-1M / CA701-1M-S	50 m
CA701-15-1M / CA701-15-1M-S	25 m
CA702 / CA802 / CA202	50
CA509/K5WHT	100
SCS0.5/3 Blade size: 0.5 x 3.0 mm	10

Type / Cat. No.	I _{max}	Standard Pack
JX2.5/2	24 A	100
JX2.5/3	24 A	50
JX2.5/4	24 A	50
JX2.5/5	24 A	50
JX2.5/6	24 A	10
JX2.5/7	24 A	10
JX2.5/8	24 A	10
JX2.5/10	24 A	10
TX2.5		50

ODLG2.5A(I.S)

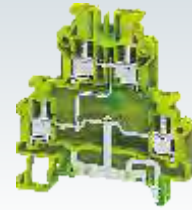

5 x 62 mm

61 mm / 68.5 mm

IEC	UL - CSA
0.2 - 2.5 mm ²	24 - 12 AWG
0.2 - 4.0 mm ²	
0.2 - 2.5 mm ²	24 - 12 AWG
0.2 - 1.5 mm ²	24 - 16 AWG
0.2 - 1.5 mm ²	24 - 16 AWG

8 mm

IEC60947-7-1 UL-1059 CSA22.2-158

800 V	300 V	300 V
24 A	25 A	25 A

0.4 Nm	4.5 lb-in	4.5 lb-in



Polyamide 6,6 / 1

8 KV / 3

Type / Cat. No.	Standard Pack
ODLG2.5A(I.S)	50
ODLG2.5(I.S)	50
EPODL2.5	50
EP1ODL2.5	50
CA701-1M / CA701-1M-S	50 m
CA701-15-1M / CA701-15-1M-S	25 m
CA702 / CA802 / CA202	50
CA509/K5WHT	100
SCS0.5/3 Blade size: 0.5 x 3.0 mm	10

Type / Cat. No.	I _{max}	Standard Pack
JX2.5/2	24 A	100
JX2.5/3	24 A	50
JX2.5/4	24 A	50
JX2.5/5	24 A	50
JX2.5/6	24 A	10
JX2.5/7	24 A	10
JX2.5/8	24 A	10
JX2.5/10	24 A	10
TX2.5		50

CDL4UN

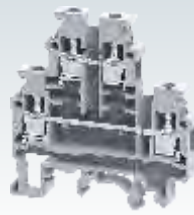

CDL4UN(I.S)



Width (Thickness) x Length	6 x 57 mm			
Height with DIN 35 x 7.5 / 35 x 15 / 32 mm Rail	59.5 mm / 67.2 mm / 64.5 mm			
Connection Possibility as per	IEC	UL - CSA		
	With 1 Conductor per clamp	Stranded / Flexible	0.2 - 4.0 mm ²	22 - 10 AWG
		Solid	0.2 - 6.0 mm ²	
With 2 same size Conductors per clamp		with Ferrule / Lug	0.2 - 4.0 mm ²	22 - 10 AWG
	Stranded / Flexible	0.2 - 2.5 mm ²	22 - 12 AWG	
		with TWIN Ferrule / Lug	0.2 - 2.5 mm ²	22 - 12 AWG
Wire Stripping Length	9 mm			
Ratings As Per	IEC60947-7-1	UL-1059	CSA22.2-158	IEC 60079-7
Voltage	800 V	600 V	600 V	550 V
Current	32 A	35 A	35 A	28 A
Torque	0.5 Nm	7 lb-in	7 lb-in	0.5 Nm

Width (Thickness) x Length	6 x 57 mm			
Height with DIN 35 x 7.5 / 35 x 15 / 32 mm Rail	59.5 mm / 67.2 mm / 64.5 mm			
Connection Possibility as per	IEC	UL - CSA		
	With 1 Conductor per clamp	Stranded / Flexible	0.2 - 4.0 mm ²	22 - 10 AWG
		Solid	0.2 - 6.0 mm ²	
With 2 same size Conductors per clamp		with Ferrule / Lug	0.2 - 4.0 mm ²	22 - 10 AWG
	Stranded / Flexible	0.2 - 2.5 mm ²	22 - 12 AWG	
		with TWIN Ferrule / Lug	0.2 - 2.5 mm ²	22 - 12 AWG
Wire Stripping Length	9 mm			
Ratings As Per	IEC60947-7-1	UL-1059	CSA22.2-158	IEC 60079-7
Voltage	800 V	600 V	600 V	
Current	32 A	35 A	35 A	
Torque	0.5 Nm	7 lb-in	7 lb-in	

Approvals

Approvals

Insulation Material / Material Group: Polyamide 6,6 / 1
 Rated Impulse Voltage / Pollution Degree: 8 KV / 3

Insulation Material / Material Group: Polyamide 6,6 / 1
 Rated Impulse Voltage / Pollution Degree: 8 KV / 3

		Type / Cat. No.	Standard Pack	
Terminal Block	Grey	CDL4UN	100	
	Blue	CDL4UNBU	100	
	Red	CDL4UNR	100	
	Yellow	CDL4UNY	100	
	Black	CDL4UNBK	100	
	Green	CDL4UNGN	100	
	Orange	CDL4UNO	100	
	White	CDL4UNW	100	
	Ground / Earth (Refer Pg. 20 for Details)		CDLG4(I.S)	100
	End Plate		EPCDL4UN	50
Separator Plate		SPCDL4U	100	
Mounting Rail (Refer Pg. 217 for details)		CA701-1M / CA701-1M-S	50 m	
		CA701-15-1M / CA701-15-1M-S	25 m	
End Clamp (Refer Pg. 218 for details)		CA702 / CA802 / CA202	50	
Marking Tags (Refer Pg. 222 for details)		CA509/K6WHT	100	
Screw Driver		SCS0.6/3.5 Blade size: 0.6 x 3.5 mm	10	

		Type / Cat. No.	Standard Pack	
Terminal Block		CDL4UN(I.S)	100	
		CDL4UN(I.S)BU	100	
		CDL4UN(I.S)R	100	
		CDL4UN(I.S)Y	100	
		CDL4UN(I.S)BK	100	
		CDL4UN(I.S)GN	100	
		CDL4UN(I.S)O	100	
		CDL4UN(I.S)W	100	
	Ground / Earth (Refer Pg. 20 for Details)		CDLG4(I.S)	100
	End Plate		EPCDL4UN	50
Separator Plate		SPCDL4U	100	
Mounting Rail (Refer Pg. 217 for details)		CA701-1M / CA701-1M-S	50 m	
		CA701-15-1M / CA701-15-1M-S	25 m	
End Clamp (Refer Pg. 218 for details)		CA702 / CA802 / CA202	50	
Marking Tags (Refer Pg. 222 for details)		CA509/K6WHT	100	
Screw Driver		SCS0.6/3.5 Blade size: 0.6 x 3.5 mm	10	

Jumpers		Uninsulated	Insulated	Imax	Standard Pack
Screw Type Jumpers		CA722/2	CA742/2	32 A	100
		CA722/3	CA742/3	32 A	100
		CA722/4	CA742/4	32 A	100
		CA722/10	CA742/10	32 A	10
		CA722/100	CA742/100	32 A	10
Configurable Jumper Bar		CA703/1		32 A	100
		CA704/1		32 A	100
		CA705/1		32 A	100
		CA732/10		32 A	100
		CA732/10-A		32 A	100
100 pole	CA732/100		32 A	10	
Short Sleeve & Screw for configurable jumper bar		CA707/S/Q/01			100
External Jumpers		CA714/2		32 A	100
		CA714/3		32 A	100
		CA714/4		32 A	100
		CA714/10		32 A	20
		CA714/10		32 A	20
Test Socket		CA707/TS/01			100

Jumpers		Uninsulated	Insulated	Imax	Standard Pack
Screw Type Jumpers		CA722/2	CA742/2	32 A	100
		CA722/3	CA742/3	32 A	100
		CA722/4	CA742/4	32 A	100
		CA722/10	CA742/10	32 A	10
		CA722/100	CA742/100	32 A	10
Configurable Jumper Bar		CA703/1		32 A	100
		CA704/1		32 A	100
		CA705/1		32 A	100
		CA732/10		32 A	100
		CA732/10-A		32 A	100
100 pole	CA732/100		32 A	10	
Short Sleeve & Screw for configurable jumper bar		CA707/S/Q/01			100
External Jumpers		CA714/2		32 A	100
		CA714/3		32 A	100
		CA714/4		32 A	100
		CA714/10		32 A	20
		CA714/10		32 A	20
Test Socket		CA707/TS/01			100

CDLG4



6 x 57 mm
59.5 mm / 67.2 mm

IEC	UL - CSA
0.2 - 4.0 mm ²	24 - 10 AWG
0.2 - 6.0 mm ²	24 - 10 AWG
0.2 - 4.0 mm ²	24 - 10 AWG
0.2 - 2.5 mm ²	24 - 12 AWG
0.2 - 2.5 mm ²	24 - 12 AWG

8 mm

IEC60947-7-2 UL-1059 CSA22.2-158

500 V	150 V	150 V
32 A	32 A	30 A

0.5 Nm	4.5 lb-in	4.5 lb-in



Polyamide 6,6 / 1

6 KV / 3

Type / Cat. No.	Standard Pack
CDLG4	100

EPCDL4UN	50
SPCDL4U	100
CA701-1M / CA701-1M-S	50 m
CA701-15-1M / CA701-15-1M-S	25 m
CA702 / CA802 / CA202	50
CA509/K6WHT	100
SCS0.6/3.5 Blade size: 0.6 x 3.5 mm	10

Uninsulated	Insulated	Imax	Standard Pack
CA722/2	CA742/2	32 A	100
CA722/3	CA742/3	32 A	100
CA722/4	CA742/4	32 A	100
CA722/10	CA742/10	32 A	10
CA722/100	CA742/100	32 A	10
CA703/1		32 A	100
CA704/1		32 A	100
CA705/1		32 A	100
CA732/10		32 A	100
CA732/10-A		32 A	100
CA732/100		32 A	10
CA707/S/Q/01			100
CA714/2		32 A	100
CA714/3		32 A	100
CA714/4		32 A	100
CA714/10		32 A	20
CA707/TS/01			100

CDLG4(I.S)

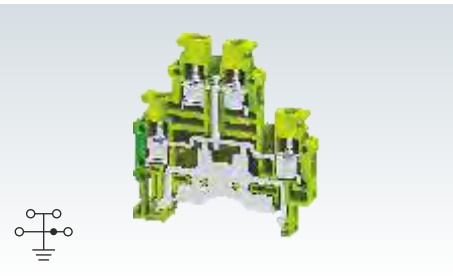

6 x 57 mm
59.5 mm / 67.2 mm

IEC	UL - CSA
0.2 - 4.0 mm ²	24 - 10 AWG
0.2 - 6.0 mm ²	24 - 10 AWG
0.2 - 4.0 mm ²	24 - 10 AWG
0.2 - 2.5 mm ²	24 - 12 AWG
0.2 - 2.5 mm ²	24 - 12 AWG

8 mm

IEC60947-7-2 UL-1059 CSA22.2-158

0.5 Nm	4.5 lb-in	4.5 lb-in



Polyamide 6,6 / 1

6 KV / 3

Type / Cat. No.	Standard Pack
CDLG4(I.S) (Green-Yellow)	100

EPCDL4UN	50
SPCDL4U	100
CA701-1M / CA701-1M-S	50 m
CA701-15-1M / CA701-15-1M-S	25 m
CA702 / CA802 / CA202	50
CA509/K6WHT	100
SCS0.6/3.5 Blade size: 0.6 x 3.5 mm	10

Uninsulated	Insulated	Imax	Standard Pack
CA722/2	CA742/2	32 A	100
CA722/3	CA742/3	32 A	100
CA722/4	CA742/4	32 A	100
CA722/10	CA742/10	32 A	10
CA722/100	CA742/100	32 A	10
CA703/1		32 A	100
CA704/1		32 A	100
CA705/1		32 A	100
CA732/10		32 A	100
CA732/10-A		32 A	100
CA732/100		32 A	10
CA707/S/Q/01			100
CA714/2		32 A	100
CA714/3		32 A	100
CA714/4		32 A	100
CA714/10		32 A	20
CA707/TS/01			100

ODL4U



6 x 68 mm
65.0 mm / 71.7 mm / 69.2 mm

IEC	UL - CSA
0.2 - 4.0 mm ²	22 - 10 AWG
0.2 - 6.0 mm ²	22 - 10 AWG
0.2 - 4.0 mm ²	22 - 10 AWG
0.2 - 2.5 mm ²	22 - 12 AWG
0.2 - 2.5 mm ²	22 - 12 AWG

9 mm

IEC60947-7-1 UL-1059 CSA22.2-158 IEC 60079-7

800 V	600 V	600 V	550 V
32 A	35 A	35 A	28 A

0.5 Nm	7 lb-in	7 lb-in	0.5 Nm



Polyamide 6,6 / 1

6 KV / 3

Type / Cat. No.	Standard Pack
ODL4U	50
ODL4UBU	50
ODL4UA (Grey Stackable)	50

EPODL4U (Front Side)	50
EP1ODL4U (Back Side)	50
CA701-1M / CA701-1M-S	50 m
CA701-15-1M / CA701-15-1M-S	25 m
CA702 / CA802 / CA202	50
CA509/K6WHT	100
SCS0.6/3.5 Blade size: 0.6 x 3.5 mm	10

Uninsulated	Insulated	Imax	Standard Pack
CA727/2	CA747/2	32 A	100
CA727/3	CA747/3	32 A	100
CA727/4	CA747/4	32 A	100
CA727/10	CA747/10	32 A	10
CA703/1		32 A	100
CA704/1		32 A	100
CA705/1		32 A	100
CA732/10		32 A	100
CA732/10-A		32 A	100
CA732/100		32 A	10
CA607/S/Q			100
CA714/2		32 A	100
CA714/3		32 A	100
CA714/4		32 A	100
CA714/10		32 A	20
CA707/TS/01			100

CDLG2.5

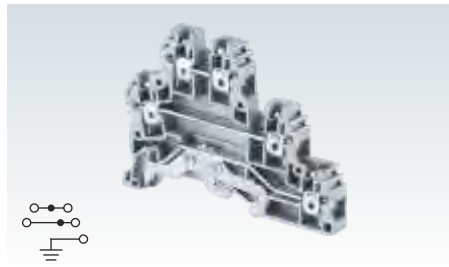

CTL2.5U



Width (Thickness) x Length

6 x 71.7 mm

6 x 84 mm

Height with DIN 35 x 7.5 / 35 x 15 / 32 mm Rail

52.5 mm / 61.0 mm

68.0 mm / 75.6 mm / 73.8 mm

Connection Possibility as per

IEC	UL - CSA
0.2 - 2.5 mm ²	24 - 12 AWG
0.2 - 4.0 mm ²	24 - 10 AWG
0.2 - 2.5 mm ²	24 - 12 AWG
0.2 - 1.5 mm ²	22 - 14 AWG
0.2 - 1.5 mm ²	22 - 16 AWG

IEC	UL - CSA
0.2 - 2.5 mm ²	22 - 12 AWG
0.2 - 4.0 mm ²	22 - 10 AWG
0.2 - 2.5 mm ²	22 - 12 AWG
0.2 - 1.5 mm ²	22 - 14 AWG
0.2 - 1.5 mm ²	22 - 14 AWG

Wire Stripping Length

9 mm

9 mm

Ratings As Per

IEC60947-7-2 UL-1059

IEC60947-7-1 UL-1059 CSA22.2-158 IEC 60079-7

Voltage

500 V 300 V

500 V 300 V 300 V 380 V

Current

24 A 24 A

24 A 25 A 25 A 21 A

Torque

0.4 Nm 4.5 lb-in

0.4 Nm 4.5 lb-in 4.5 lb-in 0.4 Nm

Approvals

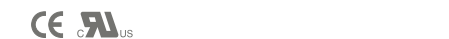

Insulation Material / Material Group

Polyamide 6,6 / 1

Polyamide 6,6 / 1

Rated Impulse Voltage / Pollution Degree

6 KV / 3

4 KV / 3

Terminal Block	Grey Blue	Type / Cat. No.	Standard Pack
End Plate		EPCDLG2.5	50
Separator Plate		SPCDLG2.5	100
Mounting Rail (Refer Pg. 217 for details)		CA701-1M / CA701-1M-S CA701-15-1M / CA701-15-1M-S	50 m 25 m
End Clamp (Refer Pg. 218 for details)		CA702 / CA802 / CA202	50
Marking Tags (Refer Pg. 222 for details)		CA509/K2GWHT	100
Screw Driver		SCS0.5/3 Blade size: 0.5 x 3 mm	10

Terminal Block	Type / Cat. No.	Standard Pack
End Plate	EPCTL2.5U	50
Separator Plate	SPCTL2.5UBU	50
Mounting Rail (Refer Pg. 217 for details)	CA701-1M / CA701-1M-S CA701-15-1M / CA701-15-1M-S	50 m 25 m
End Clamp (Refer Pg. 218 for details)	CA702 / CA802 / CA202	50
Marking Tags (Refer Pg. 222 for details)	CA509/K2WHT	100
Screw Driver	SCS0.5/3 Blade size: 0.5 x 3 mm	10

Jumpers	Type / Cat. No.	I _{max}	Standard Pack
Screw Type Jumpers	2 pole CA627/2	24 A	100
	3 pole CA627/3	24 A	100
	4 pole CA627/4	24 A	100
	10 pole CA627/10	24 A	10
	100 pole		
Jumper Bar	2 pole CA703/1	24 A	100
	3 pole CA704/1	24 A	100
	4 pole CA705/1	24 A	100
	10 pole CA732/10	24 A	100
	10 pole (Breakable) CA732/10-A	24 A	100
	100 pole CA732/100	24 A	10
Short Sleeve & Screw for configurable jumper bar	CA611/S/Q		100
External Jumpers	2 pole CA715/2	24 A	100
	3 pole CA715/3	24 A	100
	4 pole CA715/4	24 A	100
	10 pole CA715/10	24 A	20
	Test Socket	CA707/TS/01	

Jumpers	Type / Cat. No.	I _{max}	Standard Pack
Screw Type Jumpers	2 pole CA722/2	24 A	100
	3 pole CA722/3	24 A	100
	4 pole CA722/4	24 A	100
	10 pole CA722/10	24 A	10
	100 pole CA722/100	24 A	10
Jumper Bar	2 pole CA703/1	24 A	100
	3 pole CA704/1	24 A	100
	4 pole CA705/1	24 A	100
	10 pole CA732/10	24 A	100
	10 pole (Breakable) CA732/10-A	24 A	100
	100 pole CA732/100	24 A	10
Short Sleeve & Screw for configurable jumper bar	CA707/S/Q/01		100
External Jumpers	2 pole CA715/2	24 A	100
	3 pole CA715/3	24 A	100
	4 pole CA715/4	24 A	100
	10 pole CA715/10	24 A	20
	Test Socket	CA707/TS/01	

CTL2.5UH

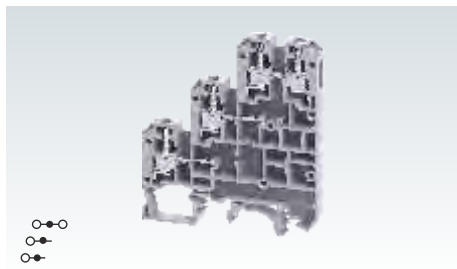

6 x 61 mm
68.0 mm / 75.6 mm / 73.8 mm

IEC	UL - CSA
0.2 - 2.5 mm ²	22 - 12 AWG
0.2 - 4.0 mm ²	22 - 10 AWG
0.2 - 2.5 mm ²	22 - 12 AWG
0.2 - 1.5 mm ²	22 - 14 AWG
0.2 - 1.5 mm ²	22 - 14 AWG

9 mm
IEC60947-7-1 UL-1059 CSA22.2-158 IEC 60079-7

500 V	300 V	300 V	380 V
24 A	25 A	25 A	21 A
0.4 Nm	4.5 lb-in	4.5 lb-in	0.4 Nm



Polyamide 6,6 / 1
4 KV / 3

Type / Cat. No.	Standard Pack
CTL2.5UH	50
CTL2.5UHBU	50
EPCTL2.5UH	50

CA701-1M / CA701-1M-S	50 m
CA701-15-1M / CA701-15-1M-S	25 m
CA702 / CA802 / CA202	50
CA509/K2WHT	100
SCS0.5/3 Blade size: 0.5 x 3 mm	10

Type / Cat. No.	I _{max}	Standard Pack
CA722/2	24 A	100
CA722/3	24 A	100
CA722/4	24 A	100
CA722/10	24 A	10
CA722/100	24 A	10
CA703/1	24 A	100
CA704/1	24 A	100
CA705/1	24 A	100
CA732/10	24 A	100
CA732/10-A	24 A	100
CA732/100	24 A	10
CA707/S/Q/01		100
CA715/2	24 A	100
CA715/3	24 A	100
CA715/4	24 A	100
CA715/10	24 A	20
CA707/TS/01		100

CTL2.5U(I.S)

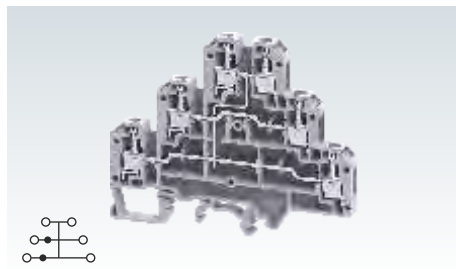

6 x 84 mm
68.0 mm / 75.6 mm / 73.8 mm

IEC	UL - CSA
0.2 - 2.5 mm ²	22 - 12 AWG
0.2 - 4.0 mm ²	22 - 10 AWG
0.2 - 2.5 mm ²	22 - 12 AWG
0.2 - 1.5 mm ²	22 - 14 AWG
0.2 - 1.5 mm ²	22 - 14 AWG

9 mm
IEC60947-7-1 UL-1059 CSA22.2-158

500 V	150 V	150 V
24 A	25 A	25 A
0.4 Nm	4.5 lb-in	4.5 lb-in



Polyamide 6,6 / 1
4 KV / 3

Type / Cat. No.	Standard Pack
CTL2.5U(I.S)	50
EPCTL2.5U	50

CA701-1M / CA701-1M-S	50 m
CA701-15-1M / CA701-15-1M-S	25 m
CA702 / CA802 / CA202	50
CA509/K2WHT	100
SCS0.5/3 Blade size: 0.5 x 3 mm	10

Type / Cat. No.	I _{max}	Standard Pack
CA722/2	24 A	100
CA722/3	24 A	100
CA722/4	24 A	100
CA722/10	24 A	10
CA722/100	24 A	10
CA703/1	24 A	100
CA704/1	24 A	100
CA705/1	24 A	100
CA732/10	24 A	100
CA732/10-A	24 A	100
CA732/100	24 A	10
CA707/S/Q/01		100
CA715/2	24 A	100
CA715/3	24 A	100
CA715/4	24 A	100
CA715/10	24 A	20
CA707/TS/01		100

CTL2.5UH(I.S)D2



6 x 61 mm
68.0 mm / 75.6 mm / 73.8 mm

IEC	UL - CSA
0.2 - 2.5 mm ²	22 - 12 AWG
0.2 - 4.0 mm ²	22 - 10 AWG
0.2 - 2.5 mm ²	22 - 12 AWG
0.2 - 1.5 mm ²	22 - 14 AWG
0.2 - 1.5 mm ²	22 - 14 AWG

9 mm
IEC60947-7-1 UL-1059

500 V	150 V
24 A	25 A
0.4 Nm	4.5 lb-in

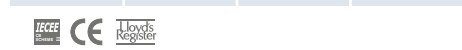

Polyamide 6,6 / 1
4 KV / 3

Type / Cat. No.	Standard Pack
CTL2.5UH(I.S)D2	50
EPCTL2.5UH	50

CA701-1M / CA701-1M-S	50 m
CA701-15-1M / CA701-15-1M-S	25 m
CA702 / CA802 / CA202	50
CA509/K2WHT	100
SCS0.5/3 Blade size: 0.5 x 3 mm	10

Type / Cat. No.	I _{max}	Standard Pack
CA722/2	24 A	100
CA722/3	24 A	100
CA722/4	24 A	100
CA722/10	24 A	10
CA722/100	24 A	10
CA703/1	24 A	100
CA704/1	24 A	100
CA705/1	24 A	100
CA732/10	24 A	100
CA732/10-A	24 A	100
CA732/100	24 A	10
CA707/S/Q/01		100
CA715/2	24 A	100
CA715/3	24 A	100
CA715/4	24 A	100
CA715/10	24 A	20
CA707/TS/01		100

CTL2.5UL

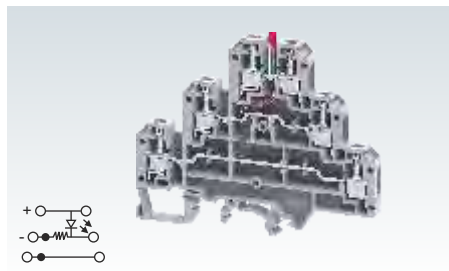

CTL2.5UHL

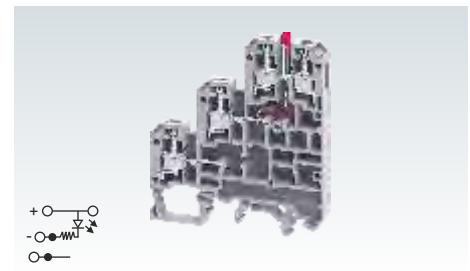

Width (Thickness) x Length	6 x 84 mm			6 x 61 mm		
Height with DIN 35 x 7.5 / 35 x 15 / 32 mm Rail	68.0 mm / 75.6 mm / 73.8 mm			68.0 mm / 75.6 mm / 73.8 mm		
Connection Possibility as per	IEC	UL - CSA		IEC	UL - CSA	
	With 1 Conductor per clamp	Stranded / Flexible	0.2 - 2.5 mm ²	22 - 12 AWG	0.2 - 2.5 mm ²	22 - 12 AWG
		Solid	0.2 - 4.0 mm ²	22 - 10 AWG	0.2 - 4.0 mm ²	22 - 10 AWG
		with Ferrule / Lug	0.2 - 2.5 mm ²	22 - 12 AWG	0.2 - 2.5 mm ²	22 - 12 AWG
With 2 same size Conductors per clamp	Stranded / Flexible	0.2 - 1.5 mm ²	22 - 14 AWG	0.2 - 1.5 mm ²	22 - 14 AWG	22 - 14 AWG
	with TWIN Ferrule / Lug	0.2 - 1.5 mm ²	22 - 14 AWG	0.2 - 1.5 mm ²	22 - 14 AWG	22 - 14 AWG
Wire Stripping Length	9 mm			9 mm		
Ratings As Per	IEC60947-7-1	UL-1059	CSA22.2-158	IEC60947-7-1	UL-1059	CSA22.2-158
Voltage	500 V	300 V	300 V	500 V	300 V	300 V
	Current	24 A	25 A	25 A	24 A	25 A
Torque	0.4 Nm	4.5 lb-in	4.5 lb-in	0.4 Nm	4.5 lb-in	4.5 lb-in
	Approvals					
Insulation Material / Material Group	Polyamide 6,6 / 1			Polyamide 6,6 / 1		
Rated Impulse Voltage / Pollution Degree	4 KV / 3			4 KV / 3		

	Type / Cat. No.	Standard Pack	Type / Cat. No.	Standard Pack
Terminal Block	CTL2.5UL*	50	CTL2.5UHL*	50
End Plate	EPCTL2.5U	50	EPCTL2.5UH	50
Mounting Rail (Refer Pg. 217 for details)	CA701-1M / CA701-1M-S	50 m	CA701-1M / CA701-1M-S	50 m
	CA701-15-1M / CA701-15-1M-S	25 m	CA701-15-1M / CA701-15-1M-S	25 m
End Clamp (Refer Pg. 218 for details)	CA702 / CA802 / CA202	50	CA702 / CA802 / CA202	50
Marking Tags (Refer Pg. 222 for details)	CA509/K2WHT	100	CA509/K2WHT	100
Screw Driver	SCS0.5/3 Blade size: 0.5 x 3 mm	10	SCS0.5/3 Blade size: 0.5 x 3 mm	10

	Type / Cat. No.	I _{max}	Standard Pack	Type / Cat. No.	I _{max}	Standard Pack	
Screw Type Jumpers	2 pole	CA722/2	24 A	100	CA722/2	24 A	100
	3 pole	CA722/3	24 A	100	CA722/3	24 A	100
	4 pole	CA722/4	24 A	100	CA722/4	24 A	100
	10 pole	CA722/10	24 A	10	CA722/10	24 A	10
	100 pole	CA722/100	24 A	10	CA722/100	24 A	10
Jumper Bar	2 pole	CA703/1	24 A	100	CA703/1	24 A	100
	3 pole	CA704/1	24 A	100	CA704/1	24 A	100
	4 pole	CA705/1	24 A	100	CA705/1	24 A	100
	10 pole	CA732/10	24 A	100	CA732/10	24 A	100
	10 pole (Breakable)	CA732/10-A	24 A	100	CA732/10-A	24 A	100
	100 pole	CA732/100	24 A	10	CA732/100	24 A	10
Short Sleeve & Screw for configurable jumper bar	CA707/S/Q/01		100	CA707/S/Q/01		100	
External Jumpers	2 pole	CA715/2	24 A	100	CA715/2	24 A	100
	3 pole	CA715/3	24 A	100	CA715/3	24 A	100
	4 pole	CA715/4	24 A	100	CA715/4	24 A	100
	10 pole	CA715/10	24 A	20	CA715/10	24 A	20
	Test Socket	CA707/TS/01		100	CA707/TS/01		100

* Standard voltage for "LED Indication" is 12 V D.C. Other variations in voltage is available on request. Add required voltage to Type / Cat. No. as suffix e.g. CTL2.5UL24 for 24V D.C.

CTLG2.5

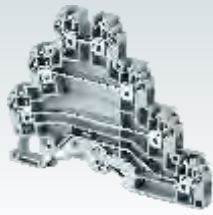

6 x 87.5 mm

66.0 mm / 74.0 mm

IEC	UL - CSA
0.2 - 2.5 mm ²	24 - 12 AWG
0.2 - 4.0 mm ²	24 - 10 AWG
0.2 - 2.5 mm ²	24 - 12 AWG
0.2 - 1.5 mm ²	24 - 14 AWG
0.2 - 1.5 mm ²	24 - 14 AWG

9 mm

IEC60947-7-1 UL-1059

440 V	300 V		
24 A	24 A		
0.4 Nm	4.5 lb-in		



Polyamide 6,6 / 1

6 KV / 3

Type / Cat. No.	Standard Pack
CTLG2.5	50
EPCTLG2.5	50
CA701-1M / CA701-1M-S	50 m
CA701-15-1M / CA701-15-1M-S	25 m
CA702 / CA802 / CA202	50
CA509/K2GWHT	100
SCS0,5/3 Blade size: 0.5 x 3 mm	10

Type / Cat. No.	I _{max}	Standard Pack
CA627/2	24 A	100
CA627/3	24 A	100
CA627/4	24 A	100
CA627/10	24 A	10
CA703/1	24 A	100
CA704/1	24 A	100
CA705/1	24 A	100
CA732/10	24 A	100
CA732/10-A	24 A	100
CA732/100	24 A	10

CA611/S/Q		100
CA715/2	24 A	100
CA715/3	24 A	100
CA715/4	24 A	100
CA715/10	24 A	20
CA707/TS/01		100

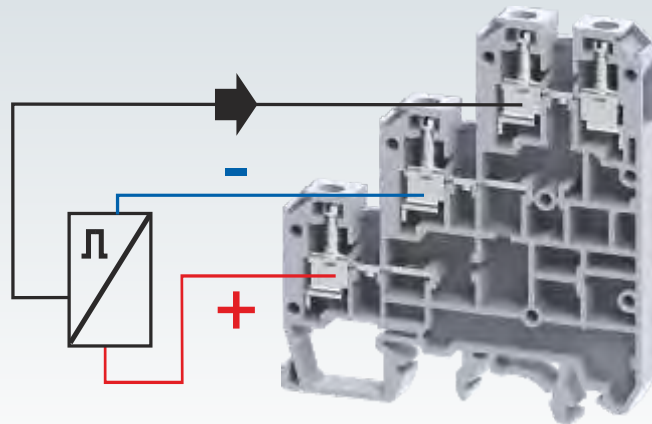
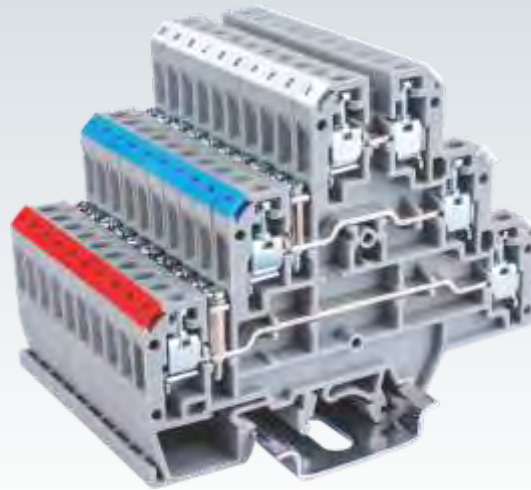

GROUND / EARTH TERMINAL BLOCKS

CGT series Terminal Blocks are used for terminating Grounding / Earthing wires. They are green-yellow colour coded as per industry standards.

CGT4N, CGT6N, CGT10N, CGT16N & CGT50/70N terminals can be mounted only on the DIN 35 & DIN 35-15 Rails. They have the same top profile as their respective feed through Terminal Blocks.





CGT4U, CGT10U & CGT35U can be mounted on the DIN 35 and DIN 32 rails.

CGMT4 is suitable for DIN 15 micro rail & can be used in conjunction with CMT4 (Pg - 63) Terminal Blocks.

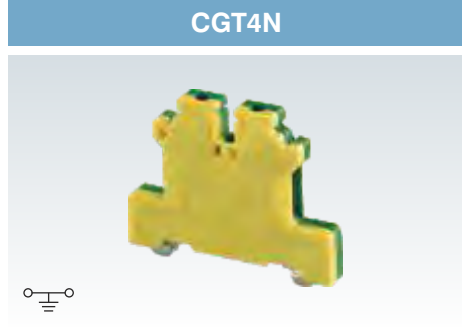
The terminals with  & IECEx approval can be used in potentially explosive atmosphere. For detailed information refer page 243.

Width (Thickness) x Length	6 x 54.5 mm			
Height with DIN 35 x 7.5 / 35 x 15 / 32 mm Rail	47.0 mm / 54.4 mm			
Connection Possibility as per	IEC		UL - CSA	
With 1 Conductor per clamp	Stranded / Flexible	0.2 - 4.0 mm ²	22 - 10 AWG	
	Solid	0.2 - 6.0 mm ²		
With 2 same size Conductors per clamp	with Ferrule / Lug	0.2 - 4.0 mm ²	22 - 10 AWG	
	Stranded / Flexible	0.2 - 2.5 mm ²	22 - 12 AWG	
with TWIN Ferrule / Lug	0.2 - 2.5 mm ²	22 - 12 AWG		
Wire Stripping Length	8 mm			
Ratings As Per	IEC60947-7-2	UL-1059	CSA22.2-158	IEC 60079-7
Torque	0.5 Nm	7 lb-in	7 lb-in	0.5 Nm
Torque at Center Screw	0.8 Nm	7 lb-in	7 lb-in	
Approvals				
Insulation Material / Material Group	Polyamide 6,6 / 1			
Rated Impulse Voltage / Pollution Degree	8 KV / 3			



	Type / Cat. No.	Standard Pack
Terminal Block	CGT4N	50
End Plate 		
Mounting Rail (Refer Pg. 217 for details) 	CA701-1M / CA701-1M-S	50 m
	CA701-15-1M / CA701-15-1M-S	25 m
Marking Tags (Refer Pg. 222 for details) 	CA509/K6WHT	100
Screw Driver 	SCS0.6/3.5 Blade size: 0.6 x 3.5 mm	10

CGT4U



6 x 43 mm

49.5 mm / 56.7 mm / 54.3 mm

IEC	UL - CSA
0.2 - 4.0 mm ²	22 - 10 AWG
0.2 - 6.0 mm ²	
0.2 - 4.0 mm ²	22 - 10 AWG
0.2 - 2.5 mm ²	22 - 12 AWG
0.2 - 2.5 mm ²	22 - 12 AWG

8 mm

IEC60947-7-2 UL-1059 CSA22.2-158 IEC 60079-7

0.5 Nm	7 lb-in	7 lb-in	0.5 Nm
0.8 Nm	7 lb-in	7 lb-in	



Polyamide 6,6 / 1

8 KV / 3

Type / Cat. No.	Standard Pack
CGT4U	50
EPCGT4UY	50
CA701-1M / CA701-1M-S	50 m
CA701-15-1M / CA701-15-1M-S	25 m
CA501-1M / CA501-1M-S	50 m
CA509/K6WHT	100
SCS0.6/3.5 Blade size: 0.6 x 3.5 mm	10

CGT6N



8 x 54.5 mm

48.2 mm / 55.8 mm

IEC	UL - CSA
0.2 - 6.0 mm ²	22 - 8 AWG
0.2 - 6.0 mm ²	
0.2 - 6.0 mm ²	22 - 8 AWG
0.2 - 4.0 mm ²	22 - 10 AWG
0.2 - 4.0 mm ²	22 - 10 AWG

9 mm

IEC60947-7-2 UL-1059 CSA22.2-158 IEC 60079-7

1.6 Nm	14 lb-in	14 lb-in	0.8 Nm
0.8 Nm	7 lb-in	7 lb-in	



Polyamide 6,6 / 1

8 KV / 3

Type / Cat. No.	Standard Pack
CGT6N	50
CA701-1M / CA701-1M-S	50 m
CA701-15-1M / CA701-15-1M-S	25 m
CA509/K8WHT	100
SCS0.8/4 Blade size: 0.8 x 4 mm	10

CGT10N



10 x 55 mm

48.5 mm / 56.0 mm

IEC	UL - CSA
0.2 - 10.0 mm ²	16 - 6 AWG
0.2 - 10.0 mm ²	
0.2 - 10.0 mm ²	16 - 6 AWG
0.2 - 6.0 mm ²	16 - 10 AWG
0.2 - 6.0 mm ²	16 - 10 AWG

11 mm

IEC60947-7-2 UL-1059 CSA22.2-158 IEC 60079-7

1.6 Nm	14 lb-in	14 lb-in	1.2 Nm
1.6 Nm	14 lb-in	14 lb-in	



Polyamide 6,6 / 1

8 KV / 3

Type / Cat. No.	Standard Pack
CGT10N	50
CA701-1M / CA701-1M-S	50 m
CA701-15-1M / CA701-15-1M-S	25 m
CA509/K10WHT	100
SCS0.8/4 Blade size: 0.8 x 4 mm	10

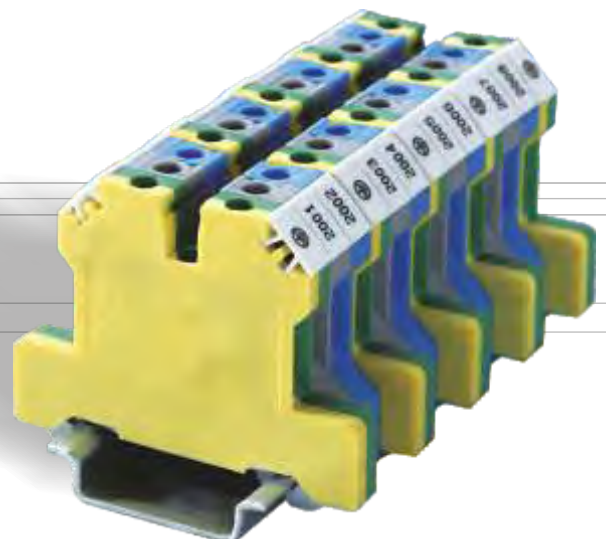

GROUND / EARTH TERMINAL BLOCKS

CGT10U



CGT16N



Width (Thickness) x Length	10 x 45 mm				12 x 55 mm			
Height with DIN 35 x 7.5 / 35 x 15 / 32 mm Rail	51.0 mm / 58.2 mm / 55.7 mm				48.5 mm / 56.0 mm			
Connection Possibility as per	IEC		UL - CSA		IEC		UL - CSA	
	0.2 - 10.0 mm ²		16 - 8 AWG		0.2 - 16.0 mm ²		20 - 4 AWG	
With 1 Conductor per clamp	Stranded / Flexible		16 - 8 AWG		0.2 - 16.0 mm ²		20 - 4 AWG	
	Solid with Ferrule / Lug		16 - 8 AWG		0.2 - 10.0 mm ²		20 - 6 AWG	
With 2 same size Conductors per clamp	Stranded / Flexible		16 - 10 AWG		0.2 - 10.0 mm ²		20 - 6 AWG	
	with TWIN Ferrule / Lug		16 - 10 AWG		0.2 - 10.0 mm ²		20 - 6 AWG	
Wire Stripping Length	11 mm				12 mm			
Ratings As Per	IEC60947-7-2	UL-1059	CSA22.2-158	IEC 60079-7	IEC60947-7-2	UL-1059	CSA22.2-158	IEC 60079-7
Torque	1.6 Nm	14 lb-in	14 lb-in	1.2 Nm	1.6 Nm	14 lb-in	14 lb-in	2.0 Nm
Torque at Center Screw	0.5 Nm	4.5 lb-in	4.5 lb-in		1.6 Nm	14 lb-in	14 lb-in	
Approvals								
Insulation Material / Material Group	Polyamide 6,6 / 1				Polyamide 6,6 / 1			
Rated Impulse Voltage / Pollution Degree	8 KV / 3				8 KV / 3			

	Type / Cat. No.	Standard Pack	Type / Cat. No.	Standard Pack
Terminal Block	CGT10U	50	CGT16N	50
Mounting Rail (Refer Pg. 217 for details)	CA701-1M / CA701-1M-S	50 m	CA701-1M / CA701-1M-S	50 m
	CA701-15-1M / CA701-15-1M-S	25 m	CA701-15-1M / CA701-15-1M-S	25 m
	CA501-1M / CA501-1M-S	50 m		
Marking Tags (Refer Pg. 222 for details)	CA509/K10WHT	100	CA509/K12WHT	100
Screw Driver	SCS0.8/4 Blade size: 0.8 x 4 mm	10	SCS1.0/5.5 Blade size: 1.0 x 5.5 mm	10

CGT35U



16 x 58 mm
63.2 mm / 70.5 mm / 68.0 mm

IEC	UL - CSA
2.5 - 35.0 mm ²	8 - 2 AWG
2.5 - 35.0 mm ²	8 - 2 AWG
2.5 - 25.0 mm ²	8 - 4 AWG

15 mm

IEC60947-7-2 UL-1059 CSA22.2-158 IEC 60079-7

2.8 Nm	25 lb-in	25 lb-in	2.5 Nm
1.2 Nm	10 lb-in	10 lb-in	



Polyamide 6,6 / 1

8 KV / 3

Type / Cat. No.	Standard Pack
CGT35U	20
CA701-1M / CA701-1M-S	50 m
CA701-15-1M / CA701-15-1M-S	25 m
CA501-1M / CA501-1M-S	50 m
CA509/K16WHT	100
SCS1.0/5.5 Blade size: 1.0 x 5.5 mm	10

CGT50/70N



20 x 77 mm
71.1 mm / 78.1 mm

IEC	UL - CSA
10.0 - 70.0 mm ²	8 - 2 AWG
10.0 - 70.0 mm ²	8 - 2 AWG
10.0 - 35.0 mm ²	8 - 2 AWG

22 mm

IEC60947-7-2 UL-1059 CSA22.2-158

3.0 Nm	38 lb-in	38 lb-in
--------	----------	----------



Polyamide 6,6 / 1

8 KV / 3

Type / Cat. No.	Standard Pack
CGT50/70N	20
CGT50/70NA	20
CA701-1M / CA701-1M-S	50 m
CA701-15-1M / CA701-15-1M-S	25 m
CA509/K16WHT	100
SCS1.0/5.5 Blade size: 1.0 x 5.5 mm	10

CGMT4



For DIN 15 Rail only

6 x 27 mm
30.7 mm (Height with DIN 15 Rail only)

IEC	UL - CSA
0.2 - 4.0 mm ²	22 - 10 AWG
0.2 - 6.0 mm ²	
0.2 - 4.0 mm ²	22 - 10 AWG
0.2 - 2.5 mm ²	22 - 12 AWG
0.2 - 2.5 mm ²	22 - 12 AWG

8 mm

IEC60947-7-2 UL-1059 CSA22.2-158 IEC 60079-7

0.8 Nm	7 lb-in	7 lb-in	0.5 Nm
0.4 Nm	3.6 lb-in	3.6 lb-in	



Polyamide 6,6 / 1

4 KV / 3

Type / Cat. No.	Standard Pack
CGMT4	100
CA601	50 m
CA509/K2WHT	100
SCS0.6/3.5 Blade size: 0.6 x 3.5 mm	10

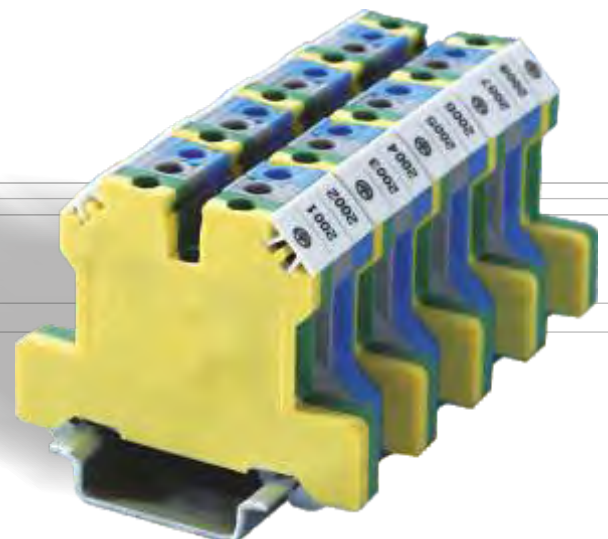

NEUTRAL / EARTH CLAMPS

The CENC series clamps are a flexible solution for terminating neutral and grounding wires on bus bar.

The NEB10 (10 x 3mm) and NEB6 (6 x 6mm) bus bar can either be panel mounted using Plastic supports NES or Din rail mounted using the end clamp CA202.

CENC4



Width (Thickness) x Length	7.5 x 23.3 mm			
Height with DIN 35 x 7.5 / 35 x 15 / 32 mm Rail				
Connection Possibility as per	IEC	UL - CSA		
With 1 Conductor per clamp	Stranded / Flexible	10.0 mm ²	22 - 12 AWG	
	Solid with Ferrule / Lug	10.0 mm ²	22 - 10 AWG	
With 2 same size Conductors per clamp	Stranded / Flexible	4.0 mm ²	22 - 14 AWG	
	with TWIN Ferrule / Lug	4.0 mm ²	22 - 14 AWG	
Wire Stripping Length	12 mm			
Ratings As Per	IEC60947-2	UL-1059	CSA22.2-158	
Voltage	800 V			
Current	57 A			
Torque	0.8 Nm	14 lb-in	14 lb-in	
Approvals				
Insulation Material / Material Group	Polyamide 6,6 / 1			
Rated Impulse Voltage / Pollution Degree	8 KV / 3			
	Type / Cat. No.	Standard Pack		
Terminal Block	Green	CENC4	50	
	Blue	CENC4BU	50	
	Black	CENC4BK	50	
	Grey	CENC4G	50	
Bus Bar 6 (H) x 6 (W) mm		NEB6	I _{max} : 140 A	10
Bus Bar 10(H) x 3 (W) mm		NEB10	I _{max} : 120 A	10
Plastic support with fixing screw		NES		50
Bus Bar Support for DIN 35 Rail Mounting		CA202		50
Marking Tags (Refer Pg. 222 for details)		CA509/K5WHT		100
Screw Driver		SCS0.8/4	Blade size: 0.8 x 4 mm	10

Note:
The current carrying capacity of the busbar (140A) should be taken into account while connecting loads.

PANEL & RAIL MOUNTING ASSEMBLY OF CENC CLAMPS



CENC16



9.8 x 23.3 mm

CENC35



14.5 x 27.3 mm

IEC	UL - CSA
10.0 - 16.0 mm ²	10 - 6 AWG
10.0 - 16.0 mm ²	10 - 6 AWG
6.0 - 10.0 mm ²	10 - 4 AWG
6.0 - 10.0 mm ²	10 - 4 AWG

16 mm

IEC60947-7-2 UL-1059 CSA22.2-158

800 V

76 A

2.0 Nm 17.5 lb-in 14 lb-in



Polyamide 6,6 / 1

8 KV / 3

Type / Cat. No.	Standard Pack
CENC16	50
CENC16BU	50
CENC16BK	50
CENC16G	50

NEB6 I_{max.}: 140 A 10

NEB10 I_{max.}: 120 A 10

NES 50

CA202 50

CA509/K6WHT 100

SCS1.0/5.5 Blade size: 1.0 x 5.5 mm 10

IEC	UL - CSA
10.0 - 35.0 mm ²	8 - 2 AWG
10.0 - 35.0 mm ²	8 - 2 AWG
10.0 - 25.0 mm ²	8 - 4 AWG
10.0 - 25.0 mm ²	8 - 4 AWG

16 mm

IEC60947-7-2 UL-1059 CSA22.2-158

800 V

125 A

2.5 Nm 25 lb-in 25 lb-in



Polyamide 6,6 / 1

8 KV / 3

Type / Cat. No.	Standard Pack
CENC35	50
CENC35BU	50
CENC35BK	50
CENC35G	50

NEB6 I_{max.}: 140 A 10

NEB10 I_{max.}: 120 A 10

NES 50

CA202 50

CA509/K6WHT 100

SCS1.0/5.5 Blade size: 1.0 x 5.5 mm 10

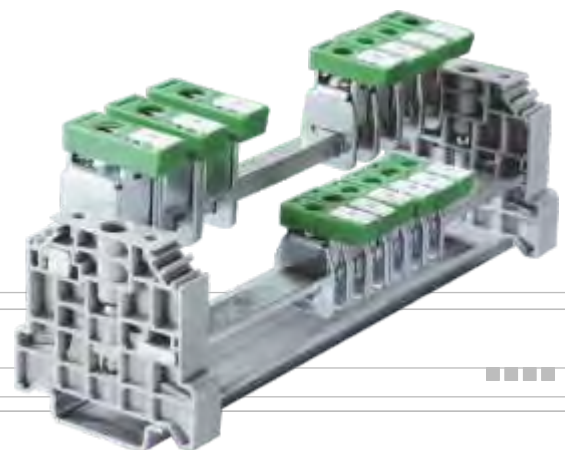

SCREW TYPE SHIELD CONNECTION CLAMPS

The screw type Shield connection clamps are available with Knurled Screw and suitable for mounting on 10 x 3 mm Busbar. These clamps can be easily used with the holder NES or NESCC.



Type of Mounting Bus bar mounting screw type shield connectors

Shield connection clamps for cable size
Ø8 mm, tightening torque 0.6 Nm
Ø14 mm, tightening torque 0.8 Nm
Ø20 mm, tightening torque 0.8 Nm
Ø35 mm, tightening torque 1.5 Nm

Type / Cat. No.	Standard Pack
CC8	10
CC14	10
CC20	10
CC35	10

Busbar 10(W) X 3(T) mm	NEB10 I _{max} : 120A	10
Mounting Support (Panel Mount)	NES	50
Mounting Support (Din 35 Rail Mounting)	NESCC	20

NEB10 I _{max} : 120A	10
NES	50
NESCC	20

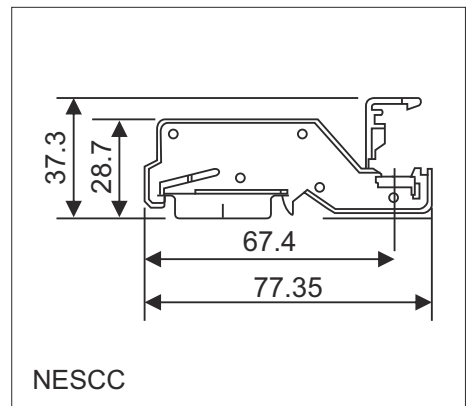
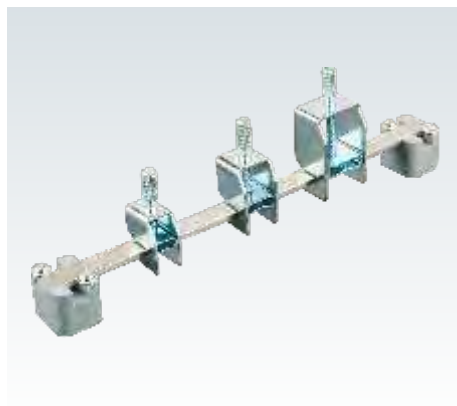
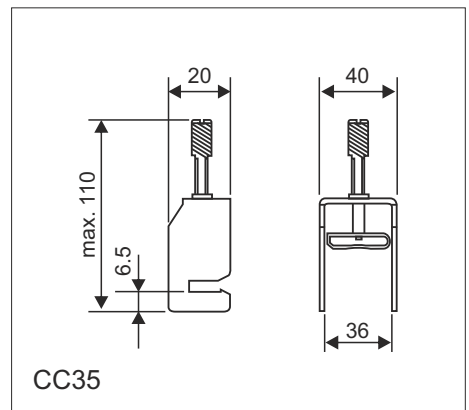
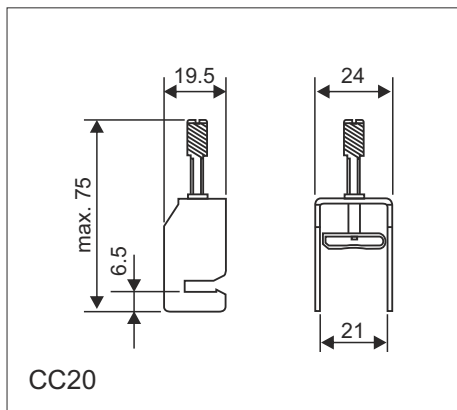
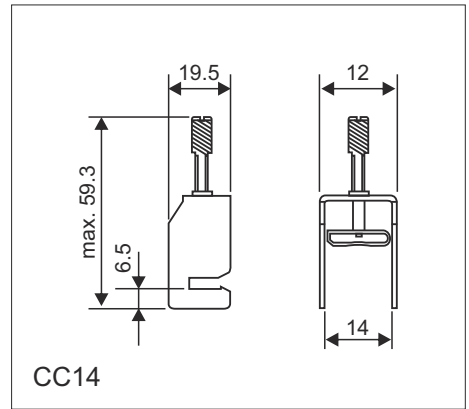
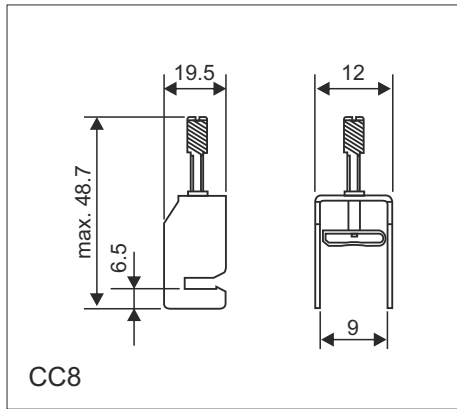

SPRING TYPE SHIELD CONNECTION CLAMPS

The electromagnetic compatibility of electrical machines and installations has become a very important aspect. Spring shield connection clamps CCS series are available in a wide range for cable and conductor sizes from diameters 2 to 32 mm.



Type of Mounting Bus bar mounting spring type shield connectors

Shield connection clamps for Busbar 10 X 3 mm		Type / Cat. No.	Standard Pack
Ø 2 - 6 mm		CCS2X2-6	10
Ø 3 - 8 mm		CCS3-8	10
Ø 4 - 13.5 mm		CCS4 -13.5	10
Ø 10 - 20 mm		CCS10-20	10
Ø 15 - 32 mm		CCS15-32	10
Busbar 10(W) X 3(T) mm		NEB10 I _{max} : 120A	10
Mounting Support (Panel Mount)		NES	50
Mounting Support (Din 35 Rail Mounting)		NESCC	20

Part No.	A	B	C
CCS 2X2 - 6	24	15	18.20
CCS 3 - 8	25.50	13.6	18.30
CCS 4 - 13.5	31	19.10	19.70
CCS 10 - 20	38.70	24.60	26.10
CCS 15 - 32	62.20	37.60	32.00

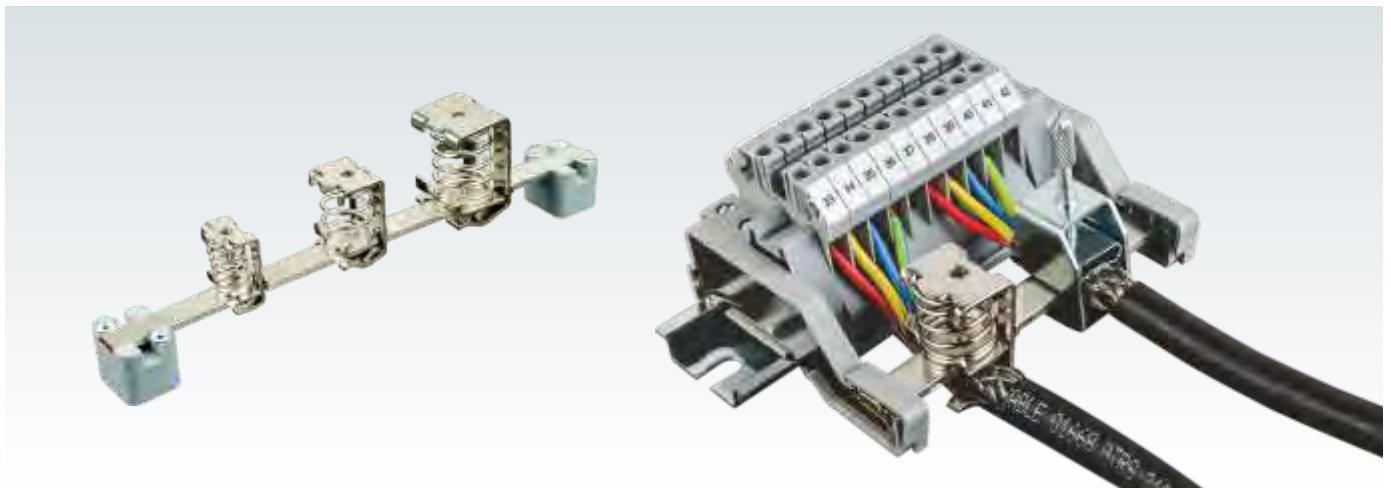
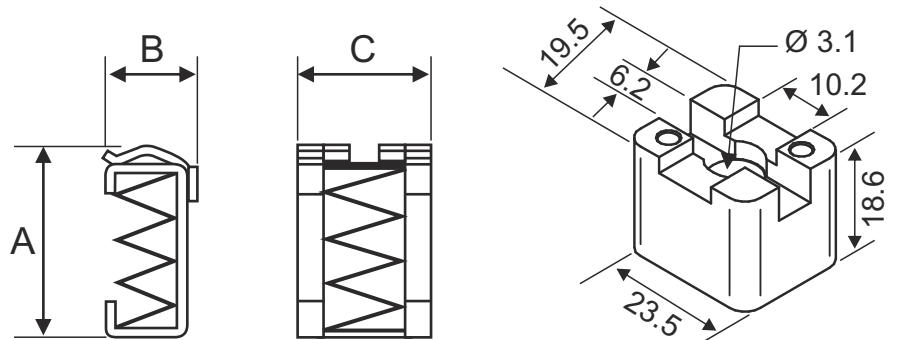

FUSE TERMINAL BLOCKS

These Terminal Blocks are used in electrical and control systems which require fuse protection.

The CF4U series Terminal Blocks accepts industry standard Ø5 x 20mm and Ø5 x 25 mm cartridge fuses. These are 8 mm thick Terminal Blocks with a provision to hold a spare fuse (in the non LED version).

CF4SP series fuse terminals, have a thickness of 6 mm with a provision for using screw type jumpers. These terminals can be used in an alternating configuration with CTS2.5UN, CTS2.5UE, CTS4UN and CF4SPFT feed through terminals.

CF4UL & CF4SPL series terminals have a built in LED circuit which gives an offline indication in case of a fuse blow out.

The CAFL series terminals accept Ø¼" x 1" and Ø¼" x 1¼" (Ø6.3 x 32 mm) fuses. Fuse blocks with suffix (L), (N) are used for off-line indication in case of a fuse blow out.

These blocks can be used with AC & DC voltages.

CF4U



Width (Thickness) x Length	8 x 57 mm		
Height with DIN 35 x 7.5 / 35 x 15 / 32 mm Rail	50.3 mm / 57.6 mm / 56.5 mm		
Connection Possibility as per	IEC		
With 1 Conductor per clamp	Stranded / Flexible	0.2 - 4.0 mm ²	
	Solid	0.2 - 6.0 mm ²	
	with Ferrule / Lug	0.2 - 4.0 mm ²	
With 2 same size Conductors per clamp	Stranded / Flexible	0.2 - 2.5 mm ²	
	with TWIN Ferrule / Lug	0.2 - 2.5 mm ²	
Wire Stripping Length	9.5 mm		
Ratings As Per	IEC60947-7-3	UL-1059	CSA22.2-158
Voltage	800 V	600 V	600 V
Current	6.3 A	10 A	10 A
Torque	0.5 Nm	7 lb-in	7 lb-in
Approvals			
Insulation Material / Material Group	Polyamide 6,6 / 1		
Rated Impulse Voltage / Pollution Degree	8 KV / 3		
Fuse Size	Ø5 x 20, Ø5 x 25 mm		

Type / Cat. No.	Standard Pack
CF4U	100
CF4UBU	100
CF4UBK	100
CF4UL6-60V	100
CF4UL110-240V	100
End Plate	
Mounting Rail (Refer Pg. 217 for details)	CA701-1M / CA701-1M-S 50 m CA701-15-1M / CA701-15-1M-S 25 m
End Clamp (Refer Pg. 218 for details)	CA702 / CA802 50
Marking Tags	CA509/K8WHT 100 CA509/K6WHT 100
Screw Driver	SCS0.6/3.5 Blade size: 0.6 x 3.5 mm 10

Jumpers	Uninsulated	Insulated	Imax	Standard Pack
Screw Type				
Jumpers				
External Jumpers				
		CA711/2	32 A	100
		CA711/3	32 A	50
		CA711/4	32 A	50
		CA711/10	32 A	20

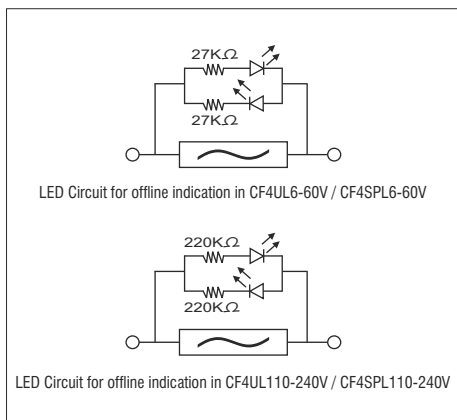

CF4SP



6 x 58.5 mm
70.0 mm / 77.5 mm / 75.0 mm

IEC	UL - CSA
0.2 - 4.0 mm ²	24 - 10 AWG
0.2 - 6.0 mm ²	
0.2 - 4.0 mm ²	24 - 10 AWG
0.2 - 2.5 mm ²	24 - 12 AWG
0.2 - 2.5 mm ²	24 - 12 AWG

8 mm

IEC60947-7-3 UL-1059 CSA22.2-158

1000 V	600 V	600 V
10 A	10 A	10 A
0.5 Nm	4.5 lb-in	4.5 lb-in



Polyamide 6,6 / 1

4 KV / 3

Ø5 x 20 mm

CAFL4U

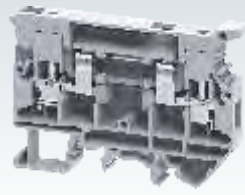

9 x 76 mm
55.3 mm / 63.0 mm / 60.3 mm

IEC	UL - CSA
0.2 - 4.0 mm ²	22 - 10 AWG
0.2 - 6.0 mm ²	
0.2 - 4.0 mm ²	22 - 10 AWG
0.2 - 2.5 mm ²	22 - 12 AWG
0.2 - 2.5 mm ²	22 - 12 AWG

9.5 mm

IEC60947-7-3 UL-1059 CSA22.2-158

1000 V	600 V	600 V
6.3 A	16 A	16 A
0.5 Nm	7 lb-in	7 lb-in



Polyamide 6,6 / 1

8 KV / 3

Ø¼" x 1", Ø¼" x 1¼" (Ø6.3 x 32 mm)

CF4SPFT

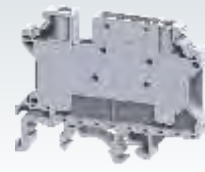

6 x 58.5 mm
46.0 mm / 53.5 mm / 51.5 mm

IEC	UL - CSA
0.2 - 4.0 mm ²	24 - 10 AWG
0.2 - 6.0 mm ²	
0.2 - 4.0 mm ²	24 - 10 AWG
0.2 - 2.5 mm ²	24 - 12 AWG
0.2 - 2.5 mm ²	24 - 12 AWG

8 mm

IEC60947-7-1 UL-1059 CSA22.2-158

1000 V	600 V	600 V
32 A	30 A	30 A
0.5 Nm	4.5 lb-in	4.5 lb-in



Polyamide 6,6 / 1

8 KV / 3

Type / Cat. No.	Standard Pack
-----------------	---------------

CF4SP	50
CF4SPBU	50
CF4SPBK	50
CF4SPL6-60V	50
CF4SPL110-240V	50

CA701-1M / CA701-1M-S	50 m
CA701-15-1M / CA701-15-1M-S	25 m

CA702 / CA802	50
---------------	----

CA509/K6WHT	100
CA509/K6WHT	100

SCS0.6/3.5 Blade size: 0.6 x 3.5 mm	10
-------------------------------------	----

Type / Cat. No.	Standard Pack
-----------------	---------------

CAFL4UW/F	25
CAFL4UBU	25
CAFL4UBK	25

CAFL4UL24V	25
CAFL4UL48V	25
CAFL4UL110V	25
CAFL4UL220V	25
CAFL4UN110V	25
CAFL4UN220V	25

EPCAFL4U	50
----------	----

CA701-1M / CA701-1M-S	50 m
CA701-15-1M / CA701-15-1M-S	25 m

CA702 / CA802	50
---------------	----

CA509/K9WHT	100
CA509/K9WHT	10

SCS0.6/3.5 Blade size: 0.6 x 3.5 mm	10
-------------------------------------	----

Type / Cat. No.	Standard Pack
-----------------	---------------

CF4SPFT	50
CF4SPFTBU	50

CA701-1M / CA701-1M-S	50 m
CA701-15-1M / CA701-15-1M-S	25 m

CA702 / CA802	50
---------------	----

CA509/K6WHT	100
-------------	-----

SCS0.6/3.5 Blade size: 0.6 x 3.5 mm	10
-------------------------------------	----

Uninsulated	Insulated	I _{max}	Standard Pack
-------------	-----------	------------------	---------------

CA722/2	CA742/2	32 A	100
CA722/3	CA742/3	32 A	100
CA722/4	CA742/4	32 A	100
CA722/10	CA742/10	32 A	10

	CA714/2	32 A	100
	CA714/3	32 A	100
	CA714/4	32 A	100
	CA714/10	32 A	20

Uninsulated	Insulated	I _{max}	Standard Pack
-------------	-----------	------------------	---------------

	CA716/2	32 A	50
	CA716/3	32 A	50
	CA716/4	32 A	50
	CA716/10	32 A	20

Uninsulated	Insulated	I _{max}	Standard Pack
-------------	-----------	------------------	---------------

CA722/2	CA742/2	32 A	100
CA722/3	CA742/3	32 A	100
CA722/4	CA742/4	32 A	100
CA722/10	CA742/10	32 A	10

	CA714/2	32 A	100
	CA714/3	32 A	100
	CA714/4	32 A	100
	CA714/10	32 A	20

DOUBLE LEVEL FUSE TERMINAL BLOCKS

These blocks have a fuse carrier on the top level and a separate feed through terminal connection at the lower level. This eliminates the use of additional feed through Terminal Blocks.

DDFL4U(E) terminals have a specially designed built in circuit which gives light indication in the event of a fuse blow out at the top level.

DDFL4ULR is a modified version of the DDFL4U Terminal Block where two equi-potential connection points are available on both sides of the Terminal Block.

DDFL4U

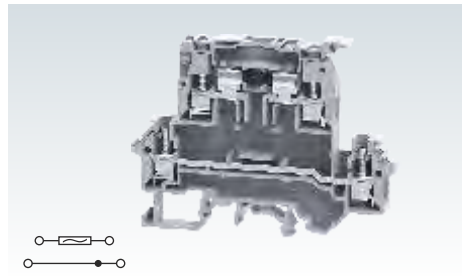

Width (Thickness) x Length	8 x 88 mm		
Height with DIN 35 x 7.5 / 35 x 15 / 32 mm Rail	67.4 mm / 74.3 mm / 71.4 mm		
Connection Possibility as per	IEC	UL - CSA	
With 1 Conductor per clamp	Stranded / Flexible	0.2 - 4.0 mm ²	22 - 10 AWG
	Solid	0.2 - 6.0 mm ²	
	with Ferrule / Lug	0.2 - 4.0 mm ²	22 - 10 AWG
With 2 same size Conductors per clamp	Stranded / Flexible	0.2 - 2.5 mm ²	22 - 12 AWG
	with TWIN Ferrule / Lug	0.2 - 2.5 mm ²	22 - 12 AWG
Wire Stripping Length	9.5 mm		
Ratings As Per	IEC60947-7-3	UL-1059	CSA22.2-158
Voltage	800 V	600 V	600 V
Current	Top Level	6.3 A	6.3 A
	Bottom Level	32 A	35 A
Torque	0.5 Nm	7 lb-in	7 lb-in
Approvals			
Insulation Material / Material Group	Polyamide 6,6 / 1		
Rated Impulse Voltage / Pollution Degree	8 kV / 3		
Fuse Size	Ø5 x 20, Ø5 x 25 mm		

		Type / Cat. No.	Standard Pack
Terminal Block	Grey	DDFL4UW/F	20
	With LED for 6 - 60 V AC/DC	DDFL4UE6-60V	20
	With LED for 110 - 240 V AC/DC	DDFL4UE110-240V	20
	With LED for 24 V AC/DC	DDFL4UE24V	20
	With LED for 48 V AC/DC	DDFL4UE48V	20
	With LED for 110 V AC/DC	DDFL4UE110V	20
	With LED for 220 V AC/DC	DDFL4UE220V	20
	With LED for 440 V AC	DDFL4UE440V	20
End Plate		EPDDFL4U	50
Mounting Rail (Refer Pg. 217 for details)		CA701-1M / CA701-1M-S	50 m
		CA701-15-1M / CA701-15-1M-S	25 m
End Clamp (Refer Pg. 218 for details)		CA702 / CA802 / CA202	50
Marking Tags	On Terminal	CA509/K8WHT	100
	Continuous Tag	CA509/K2WHT	100
Screw Driver		SCS0.6/3.5 Blade size: 0.6 x 3.5 mm	10

		Uninsulated	Insulated	I _{max}	Standard Pack
Screw Type Jumpers		CA729/2	CA749/2	32 A	100
		CA729/3	CA749/3	32 A	50
		CA729/4	CA749/4	32 A	50
		CA729/10	CA749/10	32 A	10
External Jumpers			CA711/2	32 A	100
			CA711/3	32 A	50
			CA711/4	32 A	50
			CA711/10	32 A	20

DDFL4ULR

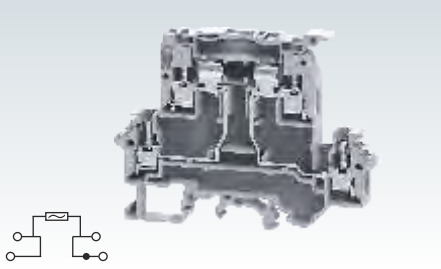

8 x 88 mm

67.4 mm / 74.3 mm / 71.4 mm

IEC	UL - CSA
0.2 - 4.0 mm ²	22 - 10 AWG
0.2 - 6.0 mm ²	
0.2 - 4.0 mm ²	22 - 10 AWG
0.2 - 2.5 mm ²	22 - 12 AWG
0.2 - 2.5 mm ²	22 - 12 AWG

9.5 mm

IEC60947-7-3 UL-1059 CSA22.2-158

800 V	600 V	600 V	
6.3 A	6.3 A	6.3 A	

0.5 Nm	7 lb-in	7 lb-in	
--------	---------	---------	--



Polyamide 6,6 / 1

8 KV / 3

Ø5 x 20, Ø5 x 25 mm

Type / Cat. No.	Standard Pack
DDFL4ULRW/F	20
DDFL4UELR24V	20
DDFL4UELR48V	20
DDFL4UELR110V	20
DDFL4UELR220V	20
DDFL4UELR440V	20
EPDDFL4U	50
CA701-1M / CA701-1M-S	50 m
CA701-15-1M / CA701-15-1M-S	25 m
CA702 / CA802 / CA202	50
CA509/K8WHT	100
CA509/K2WHT	100
SCS0.6/3.5 Blade size: 0.6 x 3.5 mm	10

Uninsulated	Insulated	I _{max}	Standard Pack
CA729/2	CA749/2	32 A	100
CA729/3	CA749/3	32 A	50
CA729/4	CA749/4	32 A	50
CA729/10	CA749/10	32 A	10
CA711/2		32 A	100
CA711/3		32 A	50
CA711/4		32 A	50
CA711/10		32 A	20

DISCONNECT & TEST TERMINAL BLOCKS

These blocks are used for measuring, control and regulatory circuits.

In CKT4U & CKT4U/4 disconnection is achieved by lifting a lever which operates the knife contact.

Specially designed socket headed screws act as receptacles for test probes in these Terminal Blocks.

CKT4U/S is another version of CKT4U Terminal Block in which regular slotted screws are used.

CKT4SP terminal provides a possibility of using screw type jumpers for cross connection.

CF4SPFT feed through terminals have the same profile as that of the CF4SP and CKT4SP Terminal Block.

CKT4SP series terminal are completely closed and do not need a separate end plate.

CKT6U terminals have the same outer profile of CTS6U feed through terminals.

CKT4UH & CKT6U terminals have an extended tab on the disconnecting blade which facilitates tool less operation of the disconnecting contact.

CKT6U terminal has the same profile as that of CTS6U & CTS10U feed through terminals.

CKT4U



Width (Thickness) x Length	6 x 46.3 mm																										
Height with DIN 35 x 7.5 / 35 x 15 / 32 mm Rail	48.3 mm / 56.0 mm / 54.5 mm																										
Connection Possibility as per	<table border="1"> <tr> <th>IEC</th> <th colspan="2">UL - CSA</th> </tr> <tr> <td>With 1 Conductor per clamp</td> <td>0.2 - 4.0 mm²</td> <td>22 - 10 AWG</td> </tr> <tr> <td>Stranded / Flexible</td> <td>0.2 - 6.0 mm²</td> <td></td> </tr> <tr> <td>Solid</td> <td>0.2 - 4.0 mm²</td> <td>22 - 10 AWG</td> </tr> <tr> <td>with Ferrule / Lug</td> <td>0.2 - 2.5 mm²</td> <td>22 - 12 AWG</td> </tr> <tr> <td>With 2 same size Conductors per clamp</td> <td>0.2 - 2.5 mm²</td> <td>22 - 12 AWG</td> </tr> <tr> <td>Stranded / Flexible</td> <td>0.2 - 2.5 mm²</td> <td>22 - 12 AWG</td> </tr> <tr> <td>with TWIN Ferrule / Lug</td> <td></td> <td></td> </tr> </table>			IEC	UL - CSA		With 1 Conductor per clamp	0.2 - 4.0 mm ²	22 - 10 AWG	Stranded / Flexible	0.2 - 6.0 mm ²		Solid	0.2 - 4.0 mm ²	22 - 10 AWG	with Ferrule / Lug	0.2 - 2.5 mm ²	22 - 12 AWG	With 2 same size Conductors per clamp	0.2 - 2.5 mm ²	22 - 12 AWG	Stranded / Flexible	0.2 - 2.5 mm ²	22 - 12 AWG	with TWIN Ferrule / Lug		
IEC	UL - CSA																										
With 1 Conductor per clamp	0.2 - 4.0 mm ²	22 - 10 AWG																									
Stranded / Flexible	0.2 - 6.0 mm ²																										
Solid	0.2 - 4.0 mm ²	22 - 10 AWG																									
with Ferrule / Lug	0.2 - 2.5 mm ²	22 - 12 AWG																									
With 2 same size Conductors per clamp	0.2 - 2.5 mm ²	22 - 12 AWG																									
Stranded / Flexible	0.2 - 2.5 mm ²	22 - 12 AWG																									
with TWIN Ferrule / Lug																											
Wire Stripping Length	8 mm																										
Ratings As Per	IEC60947-7-1 UL-1059 CSA22.2-158																										
Voltage	800 V	600 V	600 V																								
Current	28 A	35 A	16 A																								
Torque	0.5 Nm	7 lb-in	7 lb-in																								



Approvals	IEC60947-7-1 UL-1059 CSA22.2-158		
Insulation Material / Material Group	Polyamide 6,6 / 1		
Rated Impulse Voltage / Pollution Degree	8 KV / 3		

		Type / Cat. No.	Standard Pack
Terminal Block	With Standard Slotted Screw	CKT4U/S	50
	With Socket Headed Screw - Grey	CKT4U	50
	With Socket Headed Screw - Blue	CKT4UBU	50
	Disconnecting knife with Pull Tab	CKT4UH	50
End Plate		EPCKT4U	50
Mounting Rail	(Refer Pg. 217 for details)	CA701-1M / CA701-1M-S	50 m
		CA701-15-1M / CA701-15-1M-S	25 m
End Clamp	(Refer Pg. 218 for details)	CA702 / CA802	50
Marking Tags	(Refer Pg. 222 for details)	CA509/K6WHT	100
Screw Driver		SCS0.6/3.5 Blade size: 0.6 x 3.5 mm	10

Jumpers		Uninsulated	Insulated	I _{max}	Standard Pack
Screw Type Jumpers	2 pole				
	3 pole				
	4 pole				
	10 pole				
External Jumpers	2 pole		CA714/2	32 A	100
	3 pole		CA714/3	32 A	100
	4 pole		CA714/4	32 A	100
	10 pole		CA714/10	32 A	20

CKT4U/4



6 x 65 mm
54.3 mm / 62.0 mm / 60.5 mm

IEC	UL - CSA
0.2 - 4.0 mm ²	22 - 10 AWG
0.2 - 6.0 mm ²	
0.2 - 4.0 mm ²	22 - 10 AWG
0.2 - 2.5 mm ²	22 - 12 AWG
0.2 - 2.5 mm ²	22 - 12 AWG

8 mm

IEC60947-7-1 UL-1059 CSA22.2-158

800 V	600 V	600 V
-------	-------	-------

17.5 A	20 A	20 A
--------	------	------

0.5 Nm	7 lb-in	7 lb-in
--------	---------	---------



Polyamide 6,6 / 1

8 KV / 3

Type / Cat. No.	Standard Pack
CKT4U/4*	50
CKT4U/4BU	50

EPCKT4U/4	50
-----------	----

CA701-1M / CA701-1M-S	50 m
CA701-15-1M / CA701-15-1M-S	25 m

CA702 / CA802	50
---------------	----

CA509/K6WHT	100
-------------	-----

SCS0.6/3.5 Blade size: 0.6 x 3.5 mm	10
-------------------------------------	----

Uninsulated	Insulated	I _{max}	Standard Pack
	CA714/2 [#]	32 A	100
	CA714/3 [#]	32 A	100
	CA714/4 [#]	32 A	100
	CA714/10 [#]	32 A	20

CKT4SP



6 x 58.5 mm
46.0 mm / 53.5 mm / 51.5 mm

IEC	UL - CSA
0.2 - 4.0 mm ²	24 - 10 AWG
0.2 - 6.0 mm ²	
0.2 - 4.0 mm ²	24 - 10 AWG
0.2 - 2.5 mm ²	24 - 12 AWG
0.2 - 2.5 mm ²	24 - 12 AWG

8 mm

IEC60947-7-1 UL-1059 CSA22.2-158

1000 V	600 V	600 V
--------	-------	-------

28 A	30 A	30 A
------	------	------

0.5 Nm	4.5 lb-in	4.5 lb-in
--------	-----------	-----------



Polyamide 6,6 / 1

8 KV / 3

Type / Cat. No.	Standard Pack
CKT4SP	50
CKT4SPBU	50

--	--

CA701-1M / CA701-1M-S	50 m
CA701-15-1M / CA701-15-1M-S	25 m

CA702 / CA802	50
---------------	----

CA509/K6WHT	100
-------------	-----

SCS0.6/3.5 Blade size: 0.6 x 3.5 mm	10
-------------------------------------	----

Uninsulated	Insulated	I _{max}	Standard Pack
CA722/2	CA742/2	32 A	100
CA722/3	CA742/3	32 A	100
CA722/4	CA742/4	32 A	100
CA722/10	CA742/10	32 A	10
	CA714/2	32 A	100
	CA714/3	32 A	100
	CA714/4	32 A	100
	CA714/10	32 A	20

CF4SPFT



6 x 58.5 mm
46.0 mm / 53.5 mm / 51.5 mm

IEC	UL - CSA
0.2 - 4.0 mm ²	24 - 10 AWG
0.2 - 6.0 mm ²	
0.2 - 4.0 mm ²	24 - 10 AWG
0.2 - 2.5 mm ²	24 - 12 AWG
0.2 - 2.5 mm ²	24 - 12 AWG

8 mm

IEC60947-7-1 UL-1059 CSA22.2-158

1000 V	600 V	600 V
--------	-------	-------

32 A	30 A	30 A
------	------	------

0.5 Nm	4.5 lb-in	4.5 lb-in
--------	-----------	-----------



Polyamide 6,6 / 1

8 KV / 3

Type / Cat. No.	Standard Pack
CF4SPFT	50
CF4SPFTBU	50

--	--

CA701-1M / CA701-1M-S	50 m
CA701-15-1M / CA701-15-1M-S	25 m

CA702 / CA802	50
---------------	----

CA509/K6WHT	100
-------------	-----

SCS0.6/3.5 Blade size: 0.6 x 3.5 mm	10
-------------------------------------	----

Uninsulated	Insulated	I _{max}	Standard Pack
CA722/2	CA742/2	32 A	100
CA722/3	CA742/3	32 A	100
CA722/4	CA742/4	32 A	100
CA722/10	CA742/10	32 A	10
	CA714/2	32 A	100
	CA714/3	32 A	100
	CA714/4	32 A	100
	CA714/10	32 A	20

* CKT4U/4 Terminal has standard screws on the upper level clamps and socket screws on the lower level clamps.
External Jumpers can be used only in the upper level clamping unit of the Terminal Block.

CKT6U

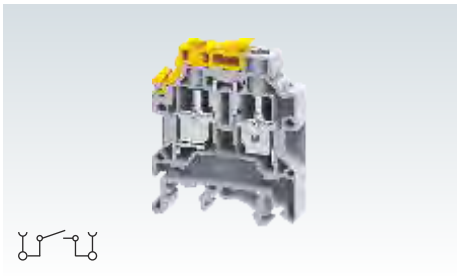

Width (Thickness) x Length	8 x 42.5 mm	
Height with DIN 35 x 7.5 / 35 x 15 / 32 mm Rail	51.2 mm / 58.7 mm / 56.1 mm	
Connection Possibility as per	IEC	UL - CSA
With 1 Conductor per clamp	Stranded / Flexible	0.5 - 6.0 mm ²
	Solid	22 - 8 AWG
With 2 same size Conductors per clamp	with Ferrule / Lug	0.5 - 6.0 mm ²
	Stranded / Flexible with TWIN Ferrule / Lug	0.5 - 2.5 mm ²
		22 - 12 AWG
Wire Stripping Length	8 mm	
Ratings As Per	IEC60947-7-1	
Voltage	1000 V	
Current	41 A	
Torque	0.8 Nm	
Approvals	CE	
Insulation Material / Material Group	Polyamide 6,6 / 1	
Rated Impulse Voltage / Pollution Degree	8 KV / 3	

		Type / Cat. No.	Standard Pack
Terminal Block	Grey	CKT6U	50
	Blue	CKT6UBU	50
End Plate		EP6/10U	50
Mounting Rail (Refer Pg. 217 for details)		CA701-1M / CA701-1M-S	50 m
		CA701-15-1M / CA701-15-1M-S	25 m
End Clamp (Refer Pg. 218 for details)		CA702 / CA802	50
Marking Tags (Refer Pg. 222 for details)		CA509/K8WHT	100
Screw Driver		SCS0.8/4 Blade size: 0.8 x 4 mm	10

Jumpers		Insulated	I _{max}	Standard Pack
External Jumpers	2 pole	CA710/2	41 A	100
	3 pole	CA710/3	41 A	50
	4 pole	CA710/4	41 A	50
	10 pole	CA710/10	41 A	20



CKT4UH Terminals

CERTIFICATIONS & APPROVALS

connectwell

is an ISO 9001:2008 Company with products and systems approved by various credible third party organizations



Cert. No.: 44 100 990789/01-E3
TUV NORD



VDE Testing & Certification Institute



Underwriters Laboratories Inc



Canadian Standards Association



ATEX - IECEX
Installation instruction refer page 243-247



(IECEE) CB Scheme



(IECEE) CE Scheme



STQC Certification Services



DISCONNECT & TEST TERMINAL BLOCKS

These blocks are used for measuring, control and regulatory circuits. They provide a clear functional advantage for devices having utility instruments and associated transformers.

In CDTTU & CDTTUSH disconnection is achieved by means of a slide link operated with a screw driver.

Specially designed socket headed screws act as receptacles for test probes in Disconnecting & Test Terminal Blocks.

CDTTUFT is a standard feed through terminal with the same profile as that of CDTTU.

CDTTU

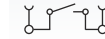

Width (Thickness) x Length	8 x 63 mm		
Height with DIN 35 x 7.5 / 35 x 15 / 32 mm Rail	58.7 mm / 65.7 mm / 63.7 mm		
Connection Possibility as per	IEC	UL - CSA	
With 1 Conductor per clamp	Stranded / Flexible	1.5 - 10.0 mm ²	16 - 8 AWG
	Solid with Ferrule / Lug	1.5 - 10.0 mm ²	16 - 8 AWG
With 2 same size Conductors per clamp	Stranded / Flexible	1.5 - 4.0 mm ²	16 - 10 AWG
	with TWIN Ferrule / Lug	1.5 - 4.0 mm ²	16 - 10 AWG
Wire Stripping Length	12 mm		
Ratings As Per	IEC60947-7-1	UL-1059	CSA22.2-158
Voltage	800 V	600 V	600 V
Current	57 A	41 A	41 A
Torque	1.2 Nm	14 lb-in	14 lb-in
Approvals			
Insulation Material / Material Group	Polyamide 6,6 / 1		
Rated Impulse Voltage / Pollution Degree	8 KV / 3		

		Type / Cat. No.	Standard Pack
Terminal Block	Grey	CDTTU	50
	Blue	CDTTUBU	50
End Plate		EPCDTTU	50
Mounting Rail (Refer Pg. 217 for details)		CA701-1M / CA701-1M-S	50 m
		CA701-15-1M / CA701-15-1M-S	25 m
End Clamp (Refer Pg. 218 for details)		CA702 / CA802	50
Marking Tags (Refer Pg. 222 for details)		CA509/K8WHT	100
Screw Driver		SCS1.0/5.5 Blade size: 1.0 x 5.5 mm	10

		Type / Cat. No.	I _{max}	Standard Pack	
External Jumpers		2 pole	CA710/2	35 A	100
		3 pole	CA710/3	35 A	50
		4 pole	CA710/4	35 A	50
		10 pole	CA710/10	35 A	20
Shorting Plug		2 pole	QJ8/2		25

CDTTUSH

CDTTUFT



16 x 63 mm
58.7 mm / 65.7 mm / 63.7 mm

8 x 63 mm
58.7 mm / 65.7 mm / 63.7 mm

IEC	UL - CSA
1.5 - 10.0 mm ²	16 - 8 AWG
1.5 - 10.0 mm ²	16 - 8 AWG
1.5 - 4.0 mm ²	16 - 10 AWG
1.5 - 4.0 mm ²	16 - 10 AWG

IEC	UL - CSA
1.5 - 10.0 mm ²	16 - 8 AWG
1.5 - 10.0 mm ²	16 - 8 AWG
1.5 - 4.0 mm ²	16 - 10 AWG
1.5 - 4.0 mm ²	16 - 10 AWG

12 mm

12 mm

IEC60947-7-1	UL-1059	CSA22.2-158
160 V	300 V	300 V
10 A	25 A	25 A
1.2 Nm	14 lb-in	14 lb-in

IEC60947-7-1	UL-1059	CSA22.2-158
800 V	600 V	600 V
57 A	41 A	41 A
1.2 Nm	14 lb-in	14 lb-in



Polyamide 6,6 / 1

Polyamide 6,6 / 1

2.5 KV / 3

8 KV / 3

Type / Cat. No.	Standard Pack
CDTTUSH	20
EPCDTTU	50
CA701-1M / CA701-1M-S	50 m
CA701-15-1M / CA701-15-1M-S	25 m
CA702 / CA802	50
CA509/K8WHT	100
SCS1.0/5.5 Blade size: 1.0 x 5.5 mm	10

Type / Cat. No.	Standard Pack
CDTTUFT	50
CDTTUFTBU	50
EPCDTTU	50
CA701-1M / CA701-1M-S	50 m
CA701-15-1M / CA701-15-1M-S	25 m
CA702 / CA802	50
CA509/K8WHT	100
SCS1.0/5.5 Blade size: 1.0 x 5.5 mm	10

Type / Cat. No.	I _{max}	Standard Pack
CA710/2	35 A	100
CA710/3	35 A	50
CA710/4	35 A	50
CA710/10	35 A	20
QJ8/2		25

Type / Cat. No.	I _{max}	Standard Pack
CA710/2	35 A	100
CA710/3	35 A	50
CA710/4	35 A	50
CA710/10	35 A	20
QJ8/2		25

DISCONNECT & TEST TERMINAL BLOCKS

The CDS6U Disconnect & Test Terminal Block is used for measuring, control and regulatory circuits. They provide a clear functional advantage for devices having utility instruments and associated transformers.

Separate testing points facilitate insertion of test probes. Disconnection is achieved by means of a slide link operated with a Screw Driver.

In the CDS6U/TS, the insulated test point screw system (TPSLS) is integrated.

CDS6U/FT Terminal Block is a standard feed through Terminal Block.

In the CDS6U/SC Disconnect & Test Terminal Block, an additional safety spring is provided underneath the screw clamp. These Terminal Blocks are preferred for connections that involve safety requirements of the Electric Supply Industry (ESI) standards, British CEBG regulations and NTPC applications.

The SLS2 and SLS4 sliding jumpers can be used in combination with either the supplied screw or the TPSLS Test point screw system.

Lock out cap LCCDS can be used to lock the center shorting screw, to prevent accidental opening of circuits.

CDS6U



Width (Thickness) x Length	8 x 82 mm																																																																																														
Height with DIN 35 x 7.5 / 35 x 15 / 32 mm Rail	51.0 mm / 59.2 mm / 56.7 mm																																																																																														
Connection Possibility as per	<table border="1"> <tr> <th>IEC</th> <th colspan="2">UL - CSA</th> </tr> <tr> <td>With 1 Conductor per clamp</td> <td colspan="2"> <table border="1"> <tr> <td>Stranded / Flexible</td> <td>0.2 - 6.0 mm²</td> <td>22 - 8 AWG</td> </tr> <tr> <td>Solid</td> <td>0.2 - 6.0 mm²</td> <td>22 - 8 AWG</td> </tr> <tr> <td>with Ferrule / Lug</td> <td>0.2 - 4.0 mm²</td> <td>22 - 10 AWG</td> </tr> <tr> <td>With 2 same size Conductors per clamp</td> <td colspan="2"> <table border="1"> <tr> <td>Stranded / Flexible</td> <td>0.2 - 4.0 mm²</td> <td>22 - 10 AWG</td> </tr> <tr> <td>with TWIN Ferrule / Lug</td> <td>0.2 - 4.0 mm²</td> <td>22 - 10 AWG</td> </tr> </table> </td> </tr> </table> </td> </tr> <tr> <td>Wire Stripping Length</td> <td colspan="3">10 mm</td> </tr> <tr> <td>Ratings As Per</td> <td colspan="3">IEC60947-7-1 UL-1059 CSA22.2-158</td> </tr> <tr> <td>Voltage</td> <td>800 V</td> <td>600 V</td> <td>600 V</td> </tr> <tr> <td>Current</td> <td>41 A</td> <td>45 A</td> <td>45 A</td> </tr> <tr> <td>Torque</td> <td>0.8 Nm</td> <td>14 lb-in</td> <td>14 lb-in</td> </tr> <tr> <td>Approvals</td> <td colspan="3"> </td> </tr> <tr> <td>Insulation Material / Material Group</td> <td colspan="3">Polyamide 6,6 / 1</td> </tr> <tr> <td>Rated Impulse Voltage / Pollution Degree</td> <td colspan="3">8 KV / 3</td> </tr> <tr> <td></td> <td colspan="2">Type / Cat. No.</td> <td>Standard Pack</td> </tr> <tr> <td>Terminal Block</td> <td colspan="2">CDS6U</td> <td>50</td> </tr> <tr> <td></td> <td colspan="2">CDS6UBU</td> <td>50</td> </tr> <tr> <td>End Plate</td> <td colspan="2">EPCDS6U</td> <td>50</td> </tr> <tr> <td>Mounting Rail (Refer Pg. 217 for details)</td> <td colspan="2">CA701-1M / CA701-1M-S</td> <td>50 m</td> </tr> <tr> <td></td> <td colspan="2">CA701-15-1M / CA701-15-1M-S</td> <td>25 m</td> </tr> <tr> <td>End Clamp (Refer Pg. 218 for details)</td> <td colspan="2">CA702 / CA802</td> <td>50</td> </tr> <tr> <td>Marking Tags (Refer Pg. 222 for details)</td> <td colspan="2">CA509/K8WHT</td> <td>100</td> </tr> <tr> <td>Screw Driver</td> <td>SCS0.8/4</td> <td>Blade size: 0.8 x 4 mm</td> <td>10</td> </tr> </table>			IEC	UL - CSA		With 1 Conductor per clamp	<table border="1"> <tr> <td>Stranded / Flexible</td> <td>0.2 - 6.0 mm²</td> <td>22 - 8 AWG</td> </tr> <tr> <td>Solid</td> <td>0.2 - 6.0 mm²</td> <td>22 - 8 AWG</td> </tr> <tr> <td>with Ferrule / Lug</td> <td>0.2 - 4.0 mm²</td> <td>22 - 10 AWG</td> </tr> <tr> <td>With 2 same size Conductors per clamp</td> <td colspan="2"> <table border="1"> <tr> <td>Stranded / Flexible</td> <td>0.2 - 4.0 mm²</td> <td>22 - 10 AWG</td> </tr> <tr> <td>with TWIN Ferrule / Lug</td> <td>0.2 - 4.0 mm²</td> <td>22 - 10 AWG</td> </tr> </table> </td> </tr> </table>		Stranded / Flexible	0.2 - 6.0 mm ²	22 - 8 AWG	Solid	0.2 - 6.0 mm ²	22 - 8 AWG	with Ferrule / Lug	0.2 - 4.0 mm ²	22 - 10 AWG	With 2 same size Conductors per clamp	<table border="1"> <tr> <td>Stranded / Flexible</td> <td>0.2 - 4.0 mm²</td> <td>22 - 10 AWG</td> </tr> <tr> <td>with TWIN Ferrule / Lug</td> <td>0.2 - 4.0 mm²</td> <td>22 - 10 AWG</td> </tr> </table>		Stranded / Flexible	0.2 - 4.0 mm ²	22 - 10 AWG	with TWIN Ferrule / Lug	0.2 - 4.0 mm ²	22 - 10 AWG	Wire Stripping Length	10 mm			Ratings As Per	IEC60947-7-1 UL-1059 CSA22.2-158			Voltage	800 V	600 V	600 V	Current	41 A	45 A	45 A	Torque	0.8 Nm	14 lb-in	14 lb-in	Approvals				Insulation Material / Material Group	Polyamide 6,6 / 1			Rated Impulse Voltage / Pollution Degree	8 KV / 3				Type / Cat. No.		Standard Pack	Terminal Block	CDS6U		50		CDS6UBU		50	End Plate	EPCDS6U		50	Mounting Rail (Refer Pg. 217 for details)	CA701-1M / CA701-1M-S		50 m		CA701-15-1M / CA701-15-1M-S		25 m	End Clamp (Refer Pg. 218 for details)	CA702 / CA802		50	Marking Tags (Refer Pg. 222 for details)	CA509/K8WHT		100	Screw Driver	SCS0.8/4	Blade size: 0.8 x 4 mm	10
IEC	UL - CSA																																																																																														
With 1 Conductor per clamp	<table border="1"> <tr> <td>Stranded / Flexible</td> <td>0.2 - 6.0 mm²</td> <td>22 - 8 AWG</td> </tr> <tr> <td>Solid</td> <td>0.2 - 6.0 mm²</td> <td>22 - 8 AWG</td> </tr> <tr> <td>with Ferrule / Lug</td> <td>0.2 - 4.0 mm²</td> <td>22 - 10 AWG</td> </tr> <tr> <td>With 2 same size Conductors per clamp</td> <td colspan="2"> <table border="1"> <tr> <td>Stranded / Flexible</td> <td>0.2 - 4.0 mm²</td> <td>22 - 10 AWG</td> </tr> <tr> <td>with TWIN Ferrule / Lug</td> <td>0.2 - 4.0 mm²</td> <td>22 - 10 AWG</td> </tr> </table> </td> </tr> </table>		Stranded / Flexible	0.2 - 6.0 mm ²	22 - 8 AWG	Solid	0.2 - 6.0 mm ²	22 - 8 AWG	with Ferrule / Lug	0.2 - 4.0 mm ²	22 - 10 AWG	With 2 same size Conductors per clamp	<table border="1"> <tr> <td>Stranded / Flexible</td> <td>0.2 - 4.0 mm²</td> <td>22 - 10 AWG</td> </tr> <tr> <td>with TWIN Ferrule / Lug</td> <td>0.2 - 4.0 mm²</td> <td>22 - 10 AWG</td> </tr> </table>		Stranded / Flexible	0.2 - 4.0 mm ²	22 - 10 AWG	with TWIN Ferrule / Lug	0.2 - 4.0 mm ²	22 - 10 AWG																																																																											
Stranded / Flexible	0.2 - 6.0 mm ²	22 - 8 AWG																																																																																													
Solid	0.2 - 6.0 mm ²	22 - 8 AWG																																																																																													
with Ferrule / Lug	0.2 - 4.0 mm ²	22 - 10 AWG																																																																																													
With 2 same size Conductors per clamp	<table border="1"> <tr> <td>Stranded / Flexible</td> <td>0.2 - 4.0 mm²</td> <td>22 - 10 AWG</td> </tr> <tr> <td>with TWIN Ferrule / Lug</td> <td>0.2 - 4.0 mm²</td> <td>22 - 10 AWG</td> </tr> </table>		Stranded / Flexible	0.2 - 4.0 mm ²	22 - 10 AWG	with TWIN Ferrule / Lug	0.2 - 4.0 mm ²	22 - 10 AWG																																																																																							
Stranded / Flexible	0.2 - 4.0 mm ²	22 - 10 AWG																																																																																													
with TWIN Ferrule / Lug	0.2 - 4.0 mm ²	22 - 10 AWG																																																																																													
Wire Stripping Length	10 mm																																																																																														
Ratings As Per	IEC60947-7-1 UL-1059 CSA22.2-158																																																																																														
Voltage	800 V	600 V	600 V																																																																																												
Current	41 A	45 A	45 A																																																																																												
Torque	0.8 Nm	14 lb-in	14 lb-in																																																																																												
Approvals																																																																																															
Insulation Material / Material Group	Polyamide 6,6 / 1																																																																																														
Rated Impulse Voltage / Pollution Degree	8 KV / 3																																																																																														
	Type / Cat. No.		Standard Pack																																																																																												
Terminal Block	CDS6U		50																																																																																												
	CDS6UBU		50																																																																																												
End Plate	EPCDS6U		50																																																																																												
Mounting Rail (Refer Pg. 217 for details)	CA701-1M / CA701-1M-S		50 m																																																																																												
	CA701-15-1M / CA701-15-1M-S		25 m																																																																																												
End Clamp (Refer Pg. 218 for details)	CA702 / CA802		50																																																																																												
Marking Tags (Refer Pg. 222 for details)	CA509/K8WHT		100																																																																																												
Screw Driver	SCS0.8/4	Blade size: 0.8 x 4 mm	10																																																																																												

		Type / Cat. No.	Imax	Standard Pack	
Screw Type Jumpers		2 pole	CA723/2	41 A	100
		3 pole	CA723/3	41 A	50
		4 pole	CA723/4	41 A	50
		5 pole	CA723/5	41 A	50
		6 pole	CA723/6	41 A	10
		10 pole	CA723/10	41 A	10
Sliding Jumpers		2 Pole	SLS2	35 A	50
		3 Pole	SLS3	35 A	25
		4 Pole	SLS4	35 A	25
Insulated Test Socket		Grey	TPSLS		50
		Red	TPSLSR		50
		Yellow	TPSLSY		50
		Blue	TPSLSBU		50
		Black	TPSLSBK		50
Switchable Jumpers		SWCDS	35 A	50	
Lock Out Cap		LCCDS		50	
Shorting Plug		2 pole	QJ8/2		25

CDS6U/TS

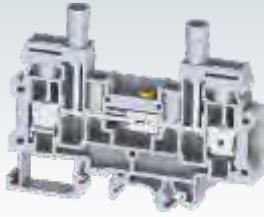

8 x 82 mm
51.0 mm / 59.2 mm / 56.7 mm

IEC	UL - CSA
0.2 - 6.0 mm ²	22 - 8 AWG
0.2 - 6.0 mm ²	22 - 8 AWG
0.2 - 4.0 mm ²	22 - 10 AWG
0.2 - 4.0 mm ²	22 - 10 AWG

10 mm

IEC60947-7-1 UL-1059 CSA22.2-158

630 V	600 V	600 V
41 A	45 A	45 A
0.8 Nm	14 lb-in	14 lb-in



Polyamide 6,6 / 1

8 KV / 3

Type / Cat. No.	Standard Pack
CDS6U/TS	50
EPCDS6U	50
CA701-1M / CA701-1M-S	50 m
CA701-15-1M / CA701-15-1M-S	25 m
CA702 / CA802	50
CA509/K8WHT	100
SCS0.8/4 Blade size: 0.8 x 4 mm	10

Type / Cat. No.	Imax	Standard Pack
CA723/2	41 A	100
CA723/3	41 A	50
CA723/4	41 A	50
CA723/5	41 A	50
CA723/6	41 A	10
CA723/10	41 A	10
SLS2	35 A	50
SLS3	35 A	25
SLS4	35 A	25

SWCDS	35 A	50
LCCDS		50
QJ8/2		25

CDS6U/FT



8 x 82 mm
51.0 mm / 59.2 mm / 56.7 mm

IEC	UL - CSA
0.2 - 6.0 mm ²	22 - 8 AWG
0.2 - 6.0 mm ²	22 - 8 AWG
0.2 - 4.0 mm ²	22 - 10 AWG
0.2 - 4.0 mm ²	22 - 10 AWG

10 mm

IEC60947-7-1 UL-1059 CSA22.2-158

1000 V	600 V	600 V
41 A	45 A	45 A
0.8 Nm	14 lb-in	14 lb-in



Polyamide 6,6 / 1

8 KV / 3

Type / Cat. No.	Standard Pack
CDS6U/FT	50
EPCDS6U	50
CA701-1M / CA701-1M-S	50 m
CA701-15-1M / CA701-15-1M-S	25 m
CA702 / CA802	50
CA509/K8WHT	100
SCS0.8/4 Blade size: 0.8 x 4 mm	10

Type / Cat. No.	Imax	Standard Pack
CA723/2	41 A	100
CA723/3	41 A	50
CA723/4	41 A	50
CA723/5	41 A	50
CA723/6	41 A	10
CA723/10	41 A	10
SLS2		
SLS3		
SLS4		

SWCDS	35 A	50
LCCDS		50
QJ8/2		25

CDS6U/SC



8 x 82 mm
51.0 mm / 59.2 mm / 56.7 mm

IEC	UL - CSA
0.2 - 6.0 mm ²	22 - 8 AWG
0.2 - 6.0 mm ²	22 - 8 AWG
0.2 - 4.0 mm ²	22 - 10 AWG
0.2 - 4.0 mm ²	22 - 10 AWG

10 mm

IEC60947-7-1 UL-1059 CSA22.2-158

800 V	600 V	600 V
41 A	45 A	45 A
0.8 Nm	14 lb-in	14 lb-in



Polyamide 6,6 / 1

8 KV / 3

Type / Cat. No.	Standard Pack
CDS6U/SC	50
EPCDS6U	50
CA701-1M / CA701-1M-S	50 m
CA701-15-1M / CA701-15-1M-S	25 m
CA702 / CA802	50
CA509/K8WHT	100
SCS0.8/4 Blade size: 0.8 x 4 mm	10

Type / Cat. No.	Imax	Standard Pack
CA723/2	41 A	100
CA723/3	41 A	50
CA723/4	41 A	50
CA723/5	41 A	50
CA723/6	41 A	10
CA723/10	41 A	10
SLS2	35 A	50
SLS3	35 A	25
SLS4	35 A	25

TPSLS		50
TPSLSR		50
TPSLSY		50
TPSLSBU		50
TPSLSBK		50

SWCDS	35 A	50
LCCDS		50
QJ8/2		25

Usage of CDS6U range of products in Simple Current Transformer Test Circuit

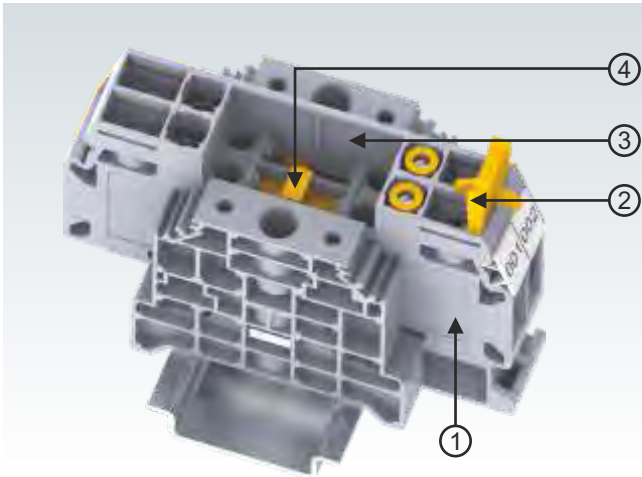

No.	Cat. No.	Qty.
1	CDS6U	2
2	SLS2	1
3	EPCDS6U	1
4	LCCDS	1

Operating status

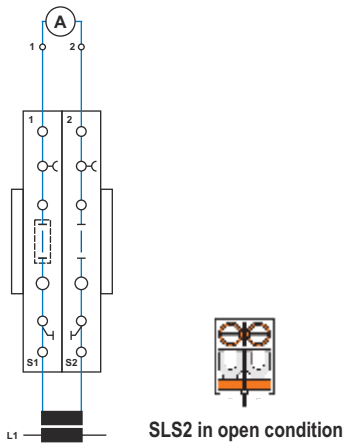

Meter test for L1 through external power supply

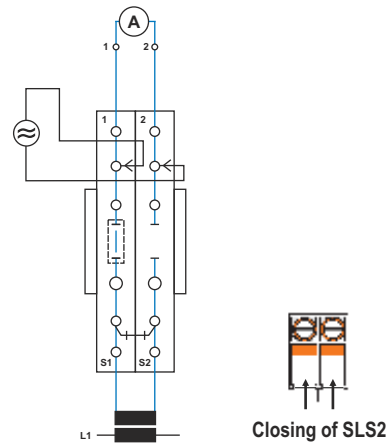

Sequence for test :

- 1) Close short circuit slide SLS2 of terminals 1 and 2.
- 2) Open disconnect slide link of terminal 2.
- 3) Connect external power supply to test sockets of terminals 1 and 2.

Comparison measurement for L1

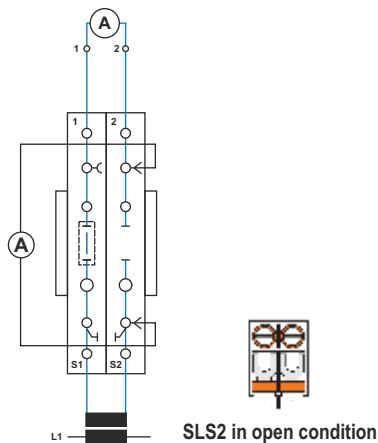

Sequence for test :

- 1) Remove SLS2 screw from terminal 2.
- 2) Connect ammeter to test sockets of terminal 2.
- 3) Open disconnect slide link of terminal 2.

Changing the meter for L1

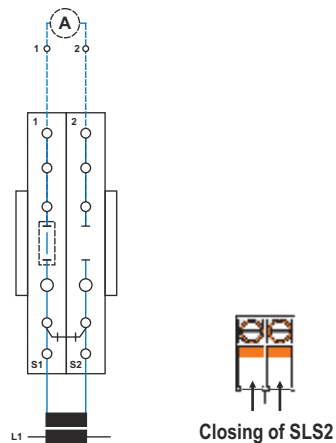

Sequence for test :

- 1) Close short circuit slide SLS2 of terminals 1 and 2.
- 2) Open disconnect slide link of terminal 2.
- 3) Disconnect meter for L1 at terminals 1 and 2.

Usage of CDS6U range of products in 3 Phase Current Transformer Test Set

Usage of CDS6U range of products in 3 Phase Linked Current Transformer Test Set

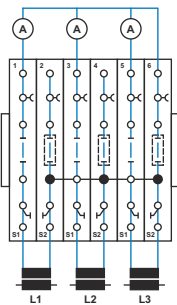
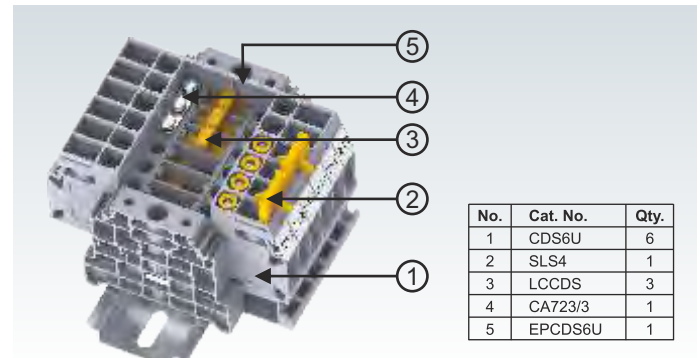
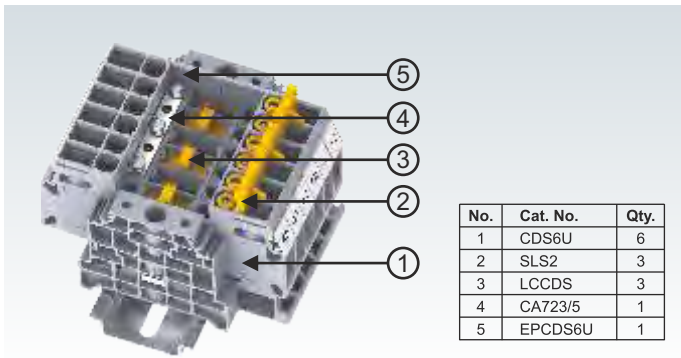

Operating status
(with internal distribution of the k-point)



SLS2 in open condition

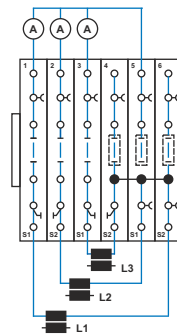

Operating status

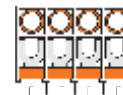

SLS4 in open condition

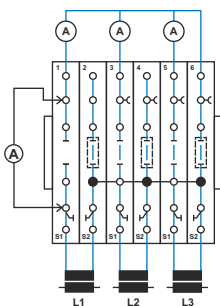

Comparison measurement for L1

Sequence for test :

- 1) Remove SLS2 screw from terminal 1.
- 2) Connect ammeter to test sockets of terminal 1.
- 3) Open disconnect slide link of terminal 1.

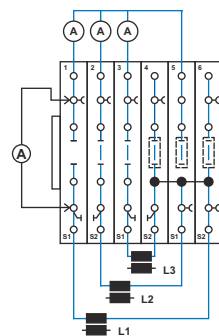

Comparison measurement for L1

Sequence for test :

- 1) Remove SLS4 screw from terminal 1.
- 2) Connect ammeter to test sockets of terminal 1.
- 3) Open disconnect slide link of terminal 1.

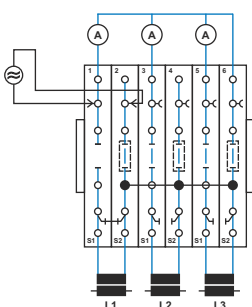

Meter test for L1 through external power supply

Sequence for test :

- 1) Close short circuit slide SLS2 of terminals 1 and 2.
- 2) Open disconnect slide link of terminal 1.
- 3) Connect external power supply to test sockets of terminals 1 and 2.

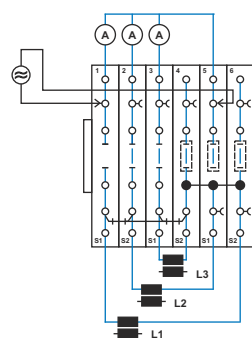

Meter test for L1 through external power supply

Sequence for test :

- 1) Close short circuit slide SLS4 of terminals 1,2, 3 and 4.
- 2) Open disconnect slide link of terminal 1.
- 3) Connect external power supply to test sockets of terminals 1 and 5.

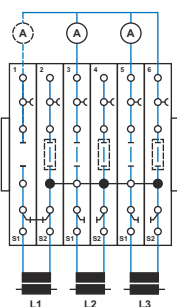

Changing the meter for L1

Sequence for test :

- 1) Close short circuit slide SLS2 of terminals 1 and 2.
- 2) Open disconnect slide link of terminal 1.
- 3) Disconnect meter for L1.

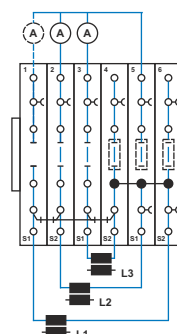

Changing the meter for L1

Sequence for test :

- 1) Close short circuit slide SLS4 of terminals 1,2, 3 and 4.
- 2) Open disconnect slide link of terminal 1.
- 3) Disconnect meter for L1.

Usage of CDS6U Test Disconnect Terminal Block for 3 Phase 4 wire multi function meter

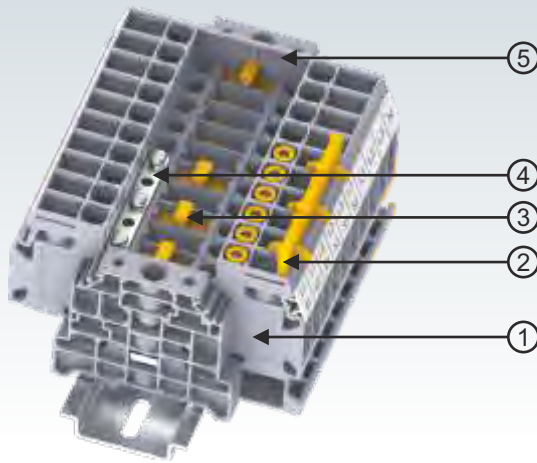

No.	Cat. No.	Qty.
1	CDS6U	10
2	SLS2	3
3	LCCDS	4
4	CA723/5	1
5	EPCDS6U	1

Operating status

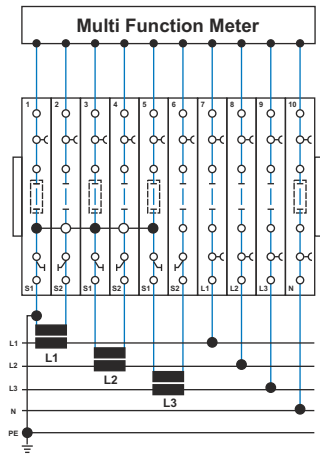

SLS2 in open condition

Meter test for L1 through external power supply

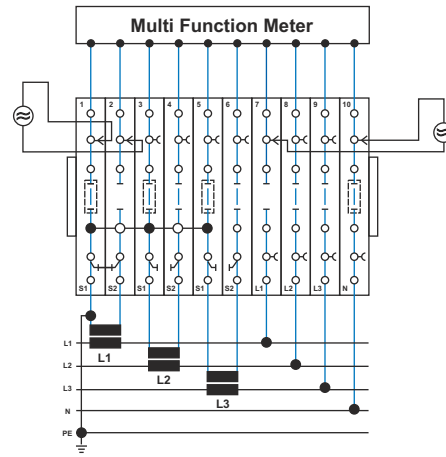

Closing of SLS2

Sequence for test :

- 1) Close short circuit slide SLS2 of terminals 1 and 2.
- 2) Open disconnect slide link of terminal 2 and 7.
- 3) Connect external power supply to test sockets of terminals 1, 2 and 7, 10.

Comparison measurement for L1

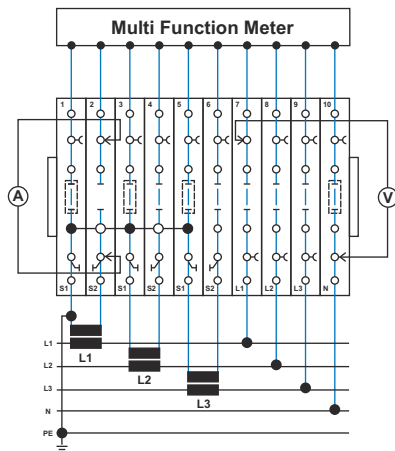

SLS2 in open condition

Sequence for test :

- 1) Remove SLS2 screw from terminal 2.
- 2) Connect ammeter to test sockets of terminal 2.
- 3) Open disconnect slide link of terminal 2.
- 4) Connect voltmeter to test sockets of terminals 7 and 10.

Changing the meter for L1

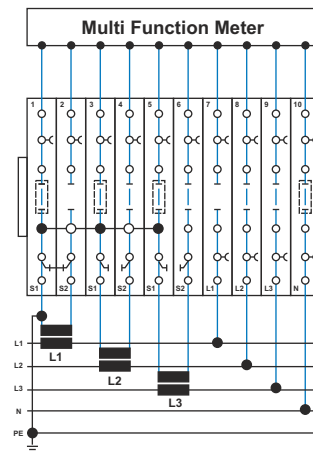

Closing of SLS2

Sequence for test :

- 1) Close short circuit slide SLS2 of terminals 1 and 2.
- 2) Open disconnect slide link of terminal 2 and 7.
- 3) Disconnect meter for L1 at terminals 1, 2 and 7.

DISCONNECT & TEST TERMINAL BLOCKS

CSDL4U



DDDL4U

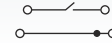

Width (Thickness) x Length	8 x 58 mm				8 x 88 mm			
Height with DIN 35 x 7.5 / 35 x 15 / 32 mm Rail	44.5 mm / 52.0 mm / 49.4 mm				67.4 mm / 74.3 mm / 71.4 mm			
Connection Possibility as per	IEC		UL - CSA		IEC		UL - CSA	
	With 1 Conductor per clamp	Stranded / Flexible Solid with Ferrule / Lug	0.2 - 4.0 mm ² 0.2 - 6.0 mm ² 0.2 - 4.0 mm ²		22 - 10 AWG		22 - 10 AWG	
With 2 same size Conductors per clamp	Stranded / Flexible with TWIN Ferrule / Lug		0.2 - 2.5 mm ² 0.2 - 2.5 mm ²		22 - 12 AWG 22 - 12 AWG		22 - 12 AWG 22 - 12 AWG	
	Wire Stripping Length		9.5 mm		9.5 mm			
Ratings As Per	IEC60947-7-1	UL-1059	CSA22.2-158		IEC60947-7-1	UL-1059	CSA22.2-158	
Voltage	1000 V		600 V		800 V		600 V	
	600 V		600 V		600 V		600 V	
Current	10 A		14 A		10 A		6.3 A	
	32 A		32 A		32 A		35 A	
Torque	0.5 Nm		7 lb-in		0.5 Nm		7 lb-in	
Approvals								
Insulation Material / Material Group	Polyamide 6,6 / 1				Polyamide 6,6 / 1			
Rated Impulse Voltage / Pollution Degree	5 KV / 3				5 KV / 3			

		Type / Cat. No.	Standard Pack			Type / Cat. No.	Standard Pack	
Terminal Block	Grey	CSDL4U	100	DDDL4U			20	
	Blue				DDDL4UBU			20
	Black				DDDL4UBK			20
End Plate		EPCSFL4U	50	EPDDL4U			50	
	Mounting Rail (Refer Pg. 217 for details)		CA701-1M / CA701-1M-S		50 m	CA701-15-1M / CA701-15-1M-S		50 m
		CA701-15-1M / CA701-15-1M-S	25 m		25 m			25 m
End Clamp (Refer Pg. 218 for details)		CA702 / CA802	50	CA702 / CA802			50	
Marking Tags	On Terminal Continuous Tag		CA509/K8WHT	100	CA509/K8WHT		100	
			CA509/K2WHT	100	CA509/K2WHT		100	
Screw Driver		SCS0.6/3.5 Blade size: 0.6 x 3.5 mm	10	SCS0.6/3.5 Blade size: 0.6 x 3.5 mm			10	

		Uninsulated	Insulated	I _{max}	Standard Pack	Uninsulated	Insulated	I _{max}	Standard Pack
Jumpers	2 pole					CA729/2	CA749/2	32 A	100
	3 pole					CA729/3	CA749/3	32 A	50
	4 pole					CA729/4	CA749/4	32 A	50
	10 pole					CA729/10	CA749/10	32 A	10
	100 pole								
Configurable Jumper Bar	2 pole					CA703/6		32 A	100
	3 pole					CA704/6		32 A	100
	4 pole					CA705/6		32 A	100
	10 pole					CA737/10		32 A	100
	Short Sleeve & Screw for configurable jumper bar						CA707/S/Q/3		
External Jumpers	2 pole		CA711/2	32 A	100		CA711/2	32 A	100
	3 pole		CA711/3	32 A	50		CA711/3	32 A	50
	4 pole		CA711/4	32 A	50		CA711/4	32 A	50
	10 pole		CA711/10	32 A	20		CA711/10	32 A	20

DISTRIBUTION BLOCKS

The CDB range of Distribution Blocks is an ideal choice for a simplified distribution system. A bolt in the center of the block provides a connection point for the incoming cable. All the terminals are internally connected and provide multiple connection points for the outgoing wires. A protective shield effectively shrouds the incoming connection.

CDB4(1) blocks are recommended for applications where the input connection point is located at one end instead of the center.

CMDB blocks are a modified version of the CDB Terminal Blocks without the central incoming terminal connection.

Note:
Sum of outgoing currents on either side of the center should not exceed half the maximum permissible incoming current

Sum of total outgoing currents should not exceed maximum permissible incoming current.

Connection for higher outgoing currents should be done through the terminal nearest to the incoming connection.

Height with DIN 35 x 7.5 / 35 x 15 / 32 mm Rail	46.2 mm / 53.7 mm / 51.1 mm		
Wire size at Input	16.0 mm ² / 8 AWG		
Connection Possibility as per	IEC	UL - CSA	
With 1 Conductor per clamp	Stranded / Flexible	0.2 - 4.0 mm ² / 22 - 10 AWG	
	Solid with Ferrule / Lug	0.2 - 6.0 mm ² / 22 - 10 AWG	
With 2 same size Conductors per clamp	Stranded / Flexible	0.2 - 4.0 mm ² / 22 - 10 AWG	
	with TWIN Ferrule / Lug	0.2 - 2.5 mm ² / 22 - 12 AWG	
Wire Stripping Length	8 mm		
Ratings As Per	IEC60947-7-1	UL-1059	CSA22.2-158
Voltage	800 V	600 V	600 V
Current	Input	64 A	50 A
	Total Output (on either side of Input)	32 A	50 A / 25 A
Torque	Input	2.0 Nm	26 lb-in
	Output	0.5 Nm	7 lb-in / 26 lb-in / 7 lb-in
Approvals			
Insulation Material / Material Group	Polyamide 6,6 / 1		
Rated Impulse Voltage / Pollution Degree	8 KV / 3		



Terminal Block	Type / Cat. No.	No. of Outputs	Standard Pack
CDB4/1		4	10
CDB4/2		8	10
CDB4/3		12	10
CDB4/4		16	10
CDB4/5		20	5
CDB4/6		24	5

Mounting Rail (Refer Pg. 217 for details)	CA701-1M / CA701-1M-S	50 m
End Clamp (Refer Pg. 218 for details)	CA701-15-1M / CA701-15-1M-S	25 m
Marking Tags (Refer Pg. 222 for details)	CA702 / CA802	50
Screw Driver	CA509/K6WHT	100
	SCS0.6/3.5 Blade size: 0.6 x 3.5 mm	10

Type / Cat. No.	H x W x T (mm)	No. of Output
CDB4/1	45 x 43 x 44	4
CDB4/2	45 x 43 x 56	8
CDB4/3	45 x 43 x 68	12
CDB4/4	45 x 43 x 80	16
CDB4/5	45 x 43 x 96	20
CDB4/6	45 x 43 x 108	24

Note: These Terminal Blocks are available in Red, Yellow, Blue, Black & Green colours.

CDB4(1)

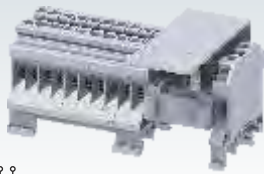

46.2 mm / 53.7 mm / 51.1 mm

16.0 mm² / 8 AWG

IEC	UL - CSA
0.2 - 4.0 mm ²	22 - 10 AWG
0.2 - 6.0 mm ²	
0.2 - 4.0 mm ²	22 - 10 AWG
0.2 - 2.5 mm ²	22 - 12 AWG
0.2 - 2.5 mm ²	22 - 12 AWG

8 mm

IEC60947-7-1 UL-1059 CSA22.2-158

800 V	600 V	600 V
64 A	50 A	50 A
64 A*	50 A	25 A
2.0 Nm	26 lb-in	26 lb-in
0.5 Nm	7 lb-in	7 lb-in



Polyamide 6,6 / 1

8 KV / 3

Type / Cat. No.	No. of Outputs	Standard Pack
CDB4/2(1)	6	10
CDB4/3(1)	8	10
CDB4/4(1)	10	10
CDB4/5(1)	12	5
CDB4/6(1)	14	5
CDB4/10(1)	22	5
CDB4/11(1)	24	5

CA701-1M / CA701-1M-S	50 m
CA701-15-1M / CA701-15-1M-S	25 m

CA702 / CA802	50
---------------	----

CA509/K6WHT	100
-------------	-----

SCS0.6/3.5 Blade size: 0.6 x 3.5 mm	10
-------------------------------------	----

Type / Cat. No.	H x W x T (mm)	No. of Output
CDB4/2(1)	45 x 43 x 52	6
CDB4/3(1)	45 x 43 x 58	8
CDB4/4(1)	45 x 43 x 64	10
CDB4/5(1)	45 x 43 x 70	12
CDB4/6(1)	45 x 43 x 76	14
CDB4/10(1)	45 x 43 x 100	22
CDB4/11(1)	45 x 43 x 106	24

CDB6



47.8 mm / 55.5 mm / 52.8 mm

25.0 mm² / 2 AWG

IEC	UL - CSA
1.5 - 6.0 mm ²	22 - 8 AWG
1.5 - 6.0 mm ²	
1.5 - 6.0 mm ²	22 - 8 AWG
1.5 - 4.0 mm ²	22 - 10 AWG
1.5 - 4.0 mm ²	22 - 10 AWG

9 mm

IEC60947-7-1 UL-1059 CSA22.2-158

800 V	600 V	600 V
82 A	100 A	100 A
41 A	50 A	50 A
3.0 Nm	35 lb-in	35 lb-in
0.8 Nm	14 lb-in	14 lb-in



Polyamide 6,6 / 1

8 KV / 3

Type / Cat. No.	No. of Outputs	Standard Pack
CDB6/1	4	10
CDB6/2	8	10
CDB6/3	12	10
CDB6/4	16	5

CA701-1M / CA701-1M-S	50 m
CA701-15-1M / CA701-15-1M-S	25 m

CA702 / CA802	50
---------------	----

CA509/K8WHT	100
-------------	-----

SCS0.8/4 Blade size: 0.8 x 4 mm	10
---------------------------------	----

Type / Cat. No.	H x W x T (mm)	No. of Output
CDB6/1	43 x 48 x 48	4
CDB6/2	43 x 48 x 64	8
CDB6/3	43 x 48 x 80	12
CDB6/4	43 x 48 x 96	16

CDB10

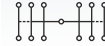
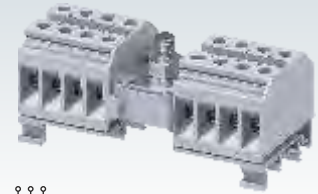

47.8 mm / 55.5 mm / 52.8 mm

35.0 mm² / 1/0 AWG

IEC	UL - CSA
1.5 - 10 mm ²	16 - 6 AWG
1.5 - 10 mm ²	
1.5 - 10 mm ²	16 - 6 AWG
1.5 - 6 mm ²	16 - 8 AWG
1.5 - 6 mm ²	16 - 8 AWG

11 mm

IEC60947-7-1 UL-1059 CSA22.2-158

800 V	600 V	600 V
114 A	130 A	130 A
57 A	65 A	65 A
6.0 Nm	53 lb-in	53 lb-in
1.2 Nm	14 lb-in	14 lb-in



Polyamide 6,6 / 1

8 KV / 3

Type / Cat. No.	No. of Outputs	Standard Pack
CDB10/2	8	10
CDB10/3	12	10
CDB10/4	16	5

CA701-1M / CA701-1M-S	50 m
CA701-15-1M / CA701-15-1M-S	25 m

CA702 / CA802	50
---------------	----

CA509/K10WHT	100
--------------	-----

SCS0.8/4 Blade size: 0.8 x 4 mm	10
---------------------------------	----

Type / Cat. No.	H x W x T (mm)	No. of Output
CDB10/2	43 x 48 x 72	8
CDB10/3	43 x 48 x 92	12
CDB10/4	43 x 48 x 112	16

Phase Distribution Application with CDB Terminals

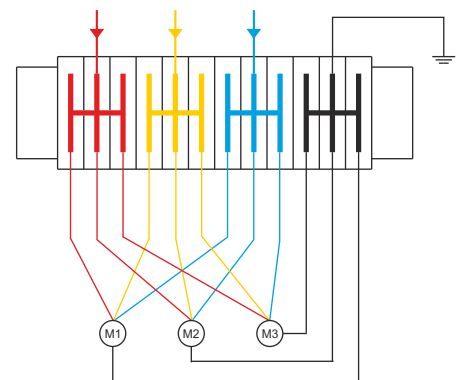

* Total output current of the system.

DISTRIBUTION BLOCKS

CDB25

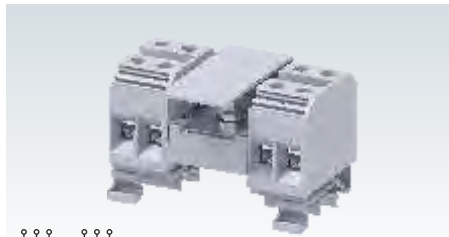

CMDB4



Height with DIN 35 x 7.5 / 35 x 15 / 32 mm Rail	57.2 mm / 64.7 mm / 62.3 mm				46.2 mm / 53.7 mm / 51.1 mm							
Wire size at Input	50.0 mm ² / 2/0 AWG											
Connection Possibility as per	IEC		UL - CSA		IEC		UL - CSA					
With 1 Conductor per clamp	Stranded / Flexible		12 - 2 AWG		0.2 - 4.0 mm ²		22 - 10 AWG					
	Solid				0.2 - 6.0 mm ²							
With 2 same size Conductors per clamp	with Ferrule / Lug		12 - 2 AWG		0.2 - 4.0 mm ²		22 - 10 AWG					
	Stranded / Flexible		12 - 8 AWG		0.2 - 2.5 mm ²		22 - 12 AWG					
	with TWIN Ferrule / Lug		12 - 8 AWG		0.2 - 2.5 mm ²		22 - 12 AWG					
Wire Stripping Length	14 mm				8 mm							
Ratings As Per	IEC60947-7-1		UL-1059		IEC60947-7-1		UL-1059					
Voltage	800 V		600 V		1000 V		600 V					
	600 V		600 V		32 A		35 A					
Current	150 A		150 A		32 A		35 A					
	75 A		75 A									
Torque	6.0 Nm		53 lb-in		0.5 Nm		7 lb-in					
	2.0 Nm		22 lb-in									
Approvals												
Insulation Material / Material Group	Polyamide 6,6 / 1				Polyamide 6,6 / 1							
Rated Impulse Voltage / Pollution Degree	8 KV / 3				8 KV / 3							
	Type / Cat. No.		No. of Outputs		Standard Pack		Type / Cat. No.		No. of Outputs		Standard Pack	
Terminal Block	CDB25/1		4		10		CMDB4/2		4		10	
	CDB25/2		8		10		CMDB4/3		6		10	
	CDB25/3		12		10		CMDB4/4		8		10	
	CDB25/4		16		5		CMDB4/10		20		5	
Mounting Rail (Refer Pg. 217 for details)	CA701-1M / CA701-1M-S		50 m		CA701-1M / CA701-1M-S		50 m					
	CA701-15-1M / CA701-15-1M-S		25 m		CA701-15-1M / CA701-15-1M-S		25 m					
End Clamp (Refer Pg. 218 for details)	CA702 / CA802		50		CA702 / CA802		50					
Marking Tags (Refer Pg. 222 for details)	CA509/K12WHT		100		CA509/K6WHT		100					
Warning Label					SWL4		50					
Screw Driver	SCS1.0/5.5 Blade size: 1.0 x 5.5 mm		10		SCS0.6/3.5 Blade size: 0.6 x 3.5 mm		10					
	Type / Cat. No.		H x W x T (mm)		No. of Output		Type / Cat. No.		H x W x T (mm)		No. of Output	
	CDB25/1		56 x 49 x 64		4		CMDB4/2		45 x 43 x 13.5		4	
	CDB25/2		56 x 49 x 88		8		CMDB4/3		45 x 43 x 19.5		6	
	CDB25/3		56 x 49 x 112		12		CMDB4/4		45 x 43 x 25.5		8	
	CDB25/4		56 x 49 x 136		16		CMDB4/10		45 x 43 x 61.5		20	

Note: These Terminal Blocks are available in Red, Yellow, Blue, Black & Green colours.

CMDB6



47.8 mm / 55.5 mm / 52.8 mm

CMDB10



47.8 mm / 55.5 mm / 52.8 mm

CMDB25



57.2 mm / 64.7 mm / 62.3 mm

IEC	UL - CSA
1.5 - 6.0 mm ²	22 - 8 AWG
1.5 - 6.0 mm ²	22 - 8 AWG
1.5 - 4.0 mm ²	22 - 10 AWG
1.5 - 4.0 mm ²	22 - 10 AWG

9 mm

IEC60947-7-1 UL-1059

1000 V	600 V		
41 A	50 A		

0.8 Nm	14 lb-in		



Polyamide 6,6 / 1

8 KV / 3

Type / Cat. No.	No. of Outputs	Standard Pack
CMDB6/2	4	10
CMDB6/3	6	10
CMDB6/4	8	5
CMDB6/10	20	5
CA701-1M / CA701-1M-S		50 m
CA701-15-1M / CA701-15-1M-S		25 m
CA702 / CA802		50
CA509/K8WHT		100
SWL6		50
SCS0.8/4	Blade size: 0.8 x 4 mm	10

Type / Cat. No.	H x W x T (mm)	No. of Output
CMDB6/2	43 x 48 x 17.5	4
CMDB6/3	43 x 48 x 25.5	6
CMDB6/4	43 x 48 x 33.5	8
CMDB6/10	43 x 48 x 81.5	20

IEC	UL - CSA
1.5 - 10.0 mm ²	22 - 6 AWG
1.5 - 10.0 mm ²	22 - 6 AWG
1.5 - 6.0 mm ²	22 - 10 AWG
1.5 - 6.0 mm ²	22 - 10 AWG

11 mm

IEC60947-7-1 UL-1059

1000 V	600 V		
57 A	65 A		

1.2 Nm	14 lb-in		



Polyamide 6,6 / 1

8 KV / 3

Type / Cat. No.	No. of Outputs	Standard Pack
CMDB10/2	4	10
CMDB10/3	6	10
CMDB10/4	8	5
CMDB10/10	20	5
CA701-1M / CA701-1M-S		50 m
CA701-15-1M / CA701-15-1M-S		25 m
CA702 / CA802		50
CA509/K10WHT		100
SCS0.8/4	Blade size: 0.8 x 4 mm	10

Type / Cat. No.	H x W x T (mm)	No. of Output
CMDB10/2	43 x 48 x 21.5	4
CMDB10/3	43 x 48 x 31.5	6
CMDB10/4	43 x 48 x 41.5	8
CMDB10/10	43 x 48 x 101.5	20

IEC	UL - CSA
6.0 - 25.0 mm ²	12 - 4 AWG
6.0 - 25.0 mm ²	12 - 4 AWG
6.0 - 16.0 mm ²	12 - 6 AWG
6.0 - 16.0 mm ²	12 - 8 AWG

14 mm

IEC60947-7-1 UL-1059 CSA22.2-158

800 V	600 V	600 V	
101 A	85 A	85 A	

2.0 Nm	22 lb-in	22 lb-in	



Polyamide 6,6 / 1

8 KV / 3

Type / Cat. No.	No. of Outputs	Standard Pack
CMDB25/2	4	10
CMDB25/3	6	10
CMDB25/4	8	5
CMDB25/10	20	5
CA701-1M / CA701-1M-S		50 m
CA701-15-1M / CA701-15-1M-S		25 m
CA702 / CA802		50
CA509/K12WHT		100
SCS1.0/5.5	Blade size: 1.0 x 5.5 mm	10

Type / Cat. No.	H x W x T (mm)	No. of Output
CMDB25/2	56 x 49 x 26	4
CMDB25/3	56 x 49 x 38	6
CMDB25/4	56 x 49 x 50	8
CMDB25/10	56 x 49 x 62	20

COMPACT DISTRIBUTION BLOCKS

Compact Distribution Block is used for single phase distribution systems. These blocks can either be mounted on a Din Rail or can be panel mounted.

These blocks are completely shrouded and offer IP 20 protection.

DB16



Width (Thickness) x Length	27 x 66 mm		
Height with DIN 35 x 7.5 / 35 x 15 mm Rail	50.8 mm / 57.8 mm		
Total number of connection points	7		
Connection Possibility as per			
At 1 Connection Point (Input)	Wire Range	6 - 16 mm ² (3 Conn.)	
	Stripping Length	15 mm	
	Torque	1.2 Nm	
At Position A in diagram below	Wire Range	2.5 - 6 mm ² (4 Conn.)	
	Stripping Length	9 mm	
	Torque	0.8 Nm	
At Position C in diagram below	Wire Range	8 - 4 AWG	
	Stripping Length	15 mm	
	Torque	14 lb-in	
Ratings As Per			
Voltage	IEC60947-7-1	UL-1059	CSA22.2-158
Current	1000 V	600 V	600 V
Approvals	76 A	80 A	80 A
Insulation Material / Material Group	Polyamide 6,6 / 1		
Rated Impulse Voltage / Pollution Degree	6 KV / 3		
Terminal Block			
	Grey	DB16	10
	Blue	DB16BU	10
	Red	DB16R	10
	Yellow	DB16Y	10
	Black	DB16BK	10
	Green	DB16GN	10
Mounting Rail (Refer Pg. 217 for details)			
	CA701-1M / CA701-1M-S	50 m	
	CA701-15-1M / CA701-15-1M-S	25 m	
End Clamp (Refer Pg. 218 for details)			
	CA702 / CA802	50	
Marking Tags (Refer Pg. 222 for details)			
	CA509/K7.5WHT	100	
Screw Driver			
	SCPH2 Blade size: 2 x 100 mm	10	

Note:
Sum of total outgoing currents should not exceed maximum permissible incoming current.

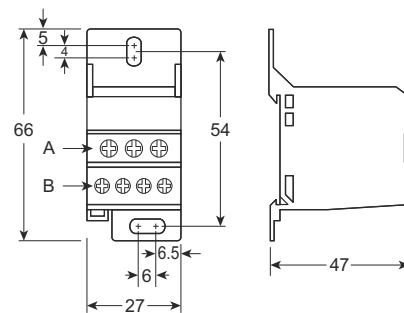

DB25



30.5 x 55.4 mm
52.1 mm / 61.35 mm
6

IEC	UL - CSA
2.5 - 25 mm ² (2 Conn.)	8 - 2 AWG
17 mm	15 mm
3.0 Nm	40 lb-in
1.5 - 10 mm ² (3 Conn.)	8 - 4 AWG
9 mm	15 mm
2.0 Nm	14 lb-in
1.5 - 10 mm ² (3 Conn.)	14 - 6 AWG
9 mm	10 mm
2.0 Nm	17.5 lb-in

IEC60947-7-1
690 V
100 A
CE VDE
Polyamide 6,6 / 1
6 KV / 3

Type / Cat. No.	Standard Pack
DB25	1
DB25BU	1
DB25GN	1
CA701-1M / CA701-1M-S	50 m
CA701-15-1M / CA701-15-1M-S	25 m
CA702 / CA802	50
SCPH2 Blade size: 2 x 100 mm	10

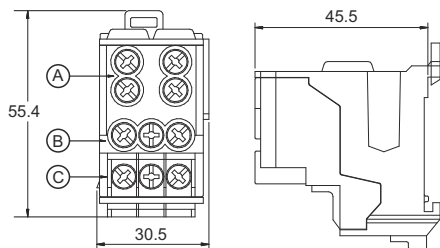

DB35



27 x 74.5 mm
50.8 mm / 57.8 mm
8

IEC	UL - CSA
6 - 35 mm ² (1 Conn.)	8 - 2 AWG
15 mm	15 mm
6 Nm	40 lb-in
6 - 16 mm ² (1 Conn.)	8 - 4 AWG
15 mm	15 mm
3 Nm	14 lb-in
2.5 - 10 mm ² (6 Conn.)	14 - 6 AWG
10 mm	10 mm
2.0 Nm	17.5 lb-in

IEC60947-7-1 UL-1059
1000 V 600 V
125 A 115 A
UL, CE, IEC, RoHS, Lloyds Register
Polyamide 6,6 / 1
6 KV / 3

Type / Cat. No.	Standard Pack
DB35	10
DB35BU	10
DB35R	10
DB35Y	10
DB35BK	10
DB35GN	10
CA701-1M / CA701-1M-S	50 m
CA701-15-1M / CA701-15-1M-S	25 m
CA702 / CA802	50
CA509/K7.5WHT	100
SCPH2 Blade size: 2 x 100 mm	10

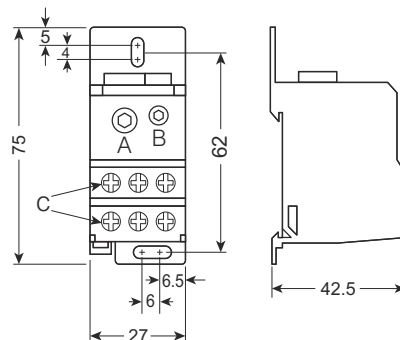

DB70



41.6 x 74.45mm
55.2 mm / 66.5 mm
8

IEC	UL - CSA
10 - 70 mm ² (1 Conn.)	8 - 1/0 AWG
17 mm	17 mm
10.0 Nm	90 lb-in
2.5 - 25 mm ² (2 Conn.)	14 - 4 AWG
12 mm	12 mm
2.0 Nm	27 lb-in
1.5 - 16 mm ² (3 Conn.)	16 - 6 AWG
12 mm	12 mm
2.0 Nm	27 lb-in

IEC60947-7-1 UL-1059
1000 V 600 V
160 A 160 A
CE, UL, VDE
Polyamide 6,6 / 1
6 KV / 3

Type / Cat. No.	Standard Pack
DB70	1
CA701-1M / CA701-1M-S	50 m
CA701-15-1M / CA701-15-1M-S	25 m
CA702 / CA802	50
SCPH2 Blade size: 2 x 100 mm	10

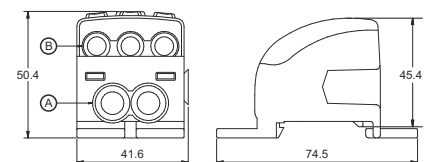

COMPACT DISTRIBUTION BLOCKS

PDB400



DB185



Width (Thickness) x Length		53.3 x 94 mm		53.3 x 94 mm	
Height with DIN 35 x 7.5 / 35 x 15 mm Rail		77.5 mm / 85.0 mm		68 mm / 74.0 mm	
Total number of connection points		8		8	
Connection Possibility as per		IEC		UL - CSA	
At 1 Connection Point (Input)	Wire Range	35 - 120 mm ² (1 Conn.)		2 - 250 KCMIL	
	Stripping Length	27 mm		19 mm	
	Torque	19.0 Nm		172 lb-in	
At 2 Connection Points (Position A in diagram)	Wire Range	4.0 - 35 mm ² (2 Conn.)		12 - 2 AWG	
	Stripping Length	18 mm		18 mm	
	Torque	2.5 Nm		54 lb-in	
At 3 Connection Point (Position B in diagram)	Wire Range	2.5 - 25 mm ² (3 Conn.)		14 - 4 AWG	
	Stripping Length	12 mm		12 mm	
	Torque	2.0 Nm		27 lb-in	
At 4 Connection Point (Position C in diagram)	Wire Range	1.5 - 16 mm ² (4 Conn.)		16 - 6 AWG	
	Stripping Length	12 mm		12 mm	
	Torque	2.0 Nm		27 lb-in	
Ratings As Per		IEC60947-7-1		UL-1059	
Voltage		1000 V		600 V	
Current		250 A		250 A	
Approvals		CE		CE, UL, VDE	
Insulation Material / Material Group		Polyamide 6,6 / 1		Polyamide 6,6 / 1	
Rated Impulse Voltage / Pollution Degree		6 KV / 3		6 KV / 3	
		Type / Cat. No.		Standard Pack	
Terminal Block		PDB400		1	
Mounting Rail (Refer Pg. 217 for details)		CA701-1M / CA701-1M-S		50 m	
		CA701-15-1M / CA701-15-1M-S		25 m	
End Clamp (Refer Pg. 218 for details)		CA702 / CA802		50	
Marking Tags (Refer Pg. 222 for details)					
Screw Driver		SCPH2	Blade size: 2 x 100 mm	10	

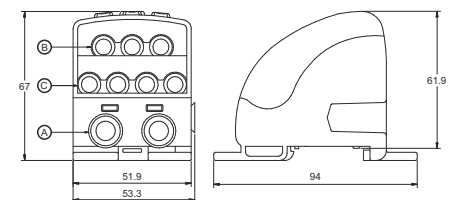
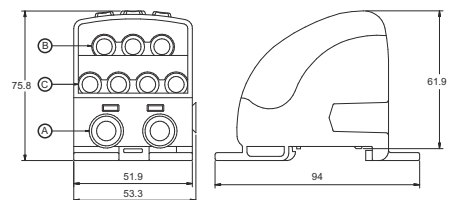

COMPONENT CARRIER TERMINAL BLOCK

The CCC4U Terminal Block is a component carrier base. Various pluggable component carriers and disconnecting plugs can be installed easily. These component carriers have built in protection against incorrect polarity.

CCC4U



Width (Thickness) x Length	6 x 58.5 mm			
Height with DIN 35 x 7.5 / 35 x 15 / 32 mm Rail	46.0 mm / 53.5 mm / 51.5 mm			
Connection Possibility as per	IEC	UL - CSA		
With 1 Conductor per clamp	Stranded / Flexible	0.2 - 4.0 mm ²	24 - 10 AWG	
	Solid	0.2 - 6.0 mm ²		
With 2 same size Conductors per clamp	with Ferrule / Lug	0.2 - 4.0 mm ²	24 - 10 AWG	
	Stranded / Flexible	0.2 - 2.5 mm ²	24 - 12 AWG	
with TWIN Ferrule / Lug		0.2 - 2.5 mm ²	24 - 12 AWG	
Wire Stripping Length	8 mm			
Ratings As Per	IEC60947-7-1	UL-1059		
Voltage	1000 V	600 V		
Current	*	*		
Torque	0.5 Nm	4.5 lb-in		
Approvals	CE			
Insulation Material / Material Group	Polyamide 6,6 / 1			
Rated Impulse Voltage / Pollution Degree	8 KV / 3			
	Type / Cat. No.	Standard Pack		
Terminal Block	CCC4U	50		
Mounting Rail (Refer Pg. 217 for details)	CA701-1M / CA701-1M-S	50 m		
	CA701-15-1M / CA701-15-1M-S	25 m		
End Clamp (Refer Pg. 218 for details)	CA702 / CA802	50		
Marking Tags (Refer Pg. 222 for details)	CA509/K6WHT	100		
Screw Driver	SCS0.6/3.5 Blade size: 0.6 x 3.5 mm	10		
	Type / Cat. No.	I _{max}	Standard Pack	
Jumpers	2 pole	CA722/2	10 A	100
	3 pole	CA722/3	10 A	100
	4 pole	CA722/4	10 A	100
	Pre Assembled Jumpers	CA722/10	10 A	10

* Current Rating is based on Plug used.

CPD1 is component plug with built in diode 1N4007. CPF is component fuse plug suitable for Ø 5 x 20 mm fuses. CPFL is component plug which provides offline indication in case of a blown off fuse. CIP is a disconnecting plug which can be installed in the base Terminal Block CCC4U.

CPD1



CPF



CIP

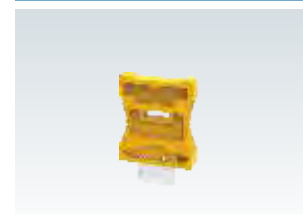

	Type / Cat. No.	Std. Pack	Type / Cat. No.	Std. Pack	Type / Cat. No.	Std. Pack
Component Carrier	CPD1	50	CPF	50		
With Diode			CPFL6-60V	50		
For Ø 5 x 20 mm Fuse			CPFL110-240V	50		
Fuse with 6-60V AC/DC LED Circuit					CIP	50
Fuse with 110-240V AC/DC LED Circuit						
Disconnection Plug						
Width (Thickness) x Length x Height	6 x 28 x 35 mm		6 x 28 x 35 mm		5.4 x 17.45 x 26 mm	
* Current Rating	1 A		6.3 A		10 A	
Marking Tags (Refer Pg. 222 for details)	CA509/K6WHT	100	CA509/K6WHT	100		

HIGH VOLTAGE TERMINAL BLOCKS

The CHV series Terminal Blocks have been specially designed for extremely high voltage (1500 VDC) applications.

A specially designed flexible foot enables easy mounting and dismounting from the mounting rail with the help of a screw driver. These Terminal Blocks have marker holding recesses to accept marking tags for circuit identification. Cross connection can be achieved with the aid of Jumpers / sleeves & screws.

CHV4U

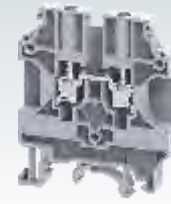

Width (Thickness) x Length		6 x 52 mm		
Height with DIN 35 x 7.5 / 35 x 15 / 32 mm Rail		63.4 mm / 70.8 mm / 68.2 mm		
Connection Possibility as per		IEC	UL - CSA	
With 1 Conductor per clamp	Stranded / Flexible	0.2 - 4.0 mm ²	22 - 10 AWG	
	Solid with Ferrule / Lug	0.2 - 6.0 mm ²	22 - 10 AWG	
With 2 same size Conductors per clamp	Stranded / Flexible	0.2 - 4.0 mm ²	22 - 10 AWG	
	with TWIN Ferrule / Lug	0.2 - 2.5 mm ²	22 - 12 AWG	
Wire Stripping Length		12 mm		
Ratings As Per		IEC60947-7-1	UL-1059	CSA22.2-158
Voltage		1000 V	1000 V	1000 V
Current		32 A	35 A	35 A
Torque		0.5 Nm	7 lb-in	7 lb-in
Approvals				
Insulation Material / Material Group		Polyamide 6,6 / 1		
Rated Impulse Voltage / Pollution Degree		8 KV / 3		
		Type / Cat. No.	Standard Pack	
Terminal Block	Grey / Blue	CHV4U	50	
		CHV4UBU	50	
End Plate		EPUSC	50	
Separator Plate		SP2.5/4UN	50	
Mounting Rail (Refer Pg. 217 for details)		CA701-1M / CA701-1M-S	50 m	
		CA701-15-1M / CA701-15-1M-S	25 m	
End Clamp (Refer Pg. 218 for details)		CA702 / CA802	50	
Marking Tags (Refer Pg. 222 for details)		CA509/K6WHT	100	
Screw Driver		SCS0.6/3.5 Blade size: 0.6 x 3.5 mm	10	
Jumpers		Type / Cat. No.	I_{max}	Standard Pack
Screw Type Jumpers		CA623/2	32 A	100
		CA623/3	32 A	100
		CA623/4	32 A	100
		CA623/10	32 A	10

CHV6U



8 x 52 mm

63.4 mm / 70.8 mm / 68.2 mm

IEC	UL - CSA
0.2 - 6.0 mm ²	22 - 8 AWG
0.2 - 6.0 mm ²	22 - 8 AWG
0.2 - 4.0 mm ²	22 - 10 AWG
0.2 - 4.0 mm ²	22 - 10 AWG

14 mm

IEC60947-7-1 UL-1059 CSA22.2-158

1000 V	1000 V	1000 V
41 A	50 A	50 A
0.8 Nm	14 lb-in	14 lb-in



Polyamide 6,6 / 1

8 KV / 3

Type / Cat. No.	Standard Pack
CHV6U	50
CHV6UBU	50
EPUSC	50
SP2.5/4UN	50
CA701-1M / CA701-1M-S	50 m
CA701-15-1M / CA701-15-1M-S	25 m
CA702 / CA802	50
CA509/K8WHT	100
SCS0.8/4 Blade size: 0.8 x 4 mm	10

Type / Cat. No.	I _{max}	Standard Pack
CA624/2	41 A	100
CA624/3	41 A	100
CA624/4	41 A	100
CA624/10	41 A	10

CHV10U

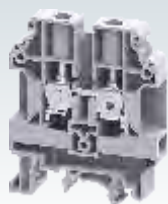

10 x 52 mm

63.4 mm / 70.8 mm / 68.2 mm

IEC	UL - CSA
0.2 - 10.0 mm ²	20 - 6 AWG
0.2 - 10.0 mm ²	20 - 6 AWG
0.2 - 6.0 mm ²	22 - 10 AWG
0.2 - 6.0 mm ²	22 - 10 AWG

14 mm

IEC60947-7-1 UL-1059 CSA22.2-158

1000 V	1000 V	1000 V
57 A	65 A	65 A
1.2 Nm	14 lb-in	14 lb-in



Polyamide 6,6 / 1

8 KV / 3

Type / Cat. No.	Standard Pack
CHV10U	50
CHV10UBU	50
EPUSC	50
SP2.5/4UN	50
CA701-1M / CA701-1M-S	50 m
CA701-15-1M / CA701-15-1M-S	25 m
CA702 / CA802	50
CA509/K10WHT	100
SCS0.8/4 Blade size: 0.8 x 4 mm	10

Type / Cat. No.	I _{max}	Standard Pack
CA625/2	57 A	100
CA625/3	57 A	100
CA625/4	57 A	100
CA625/10	57 A	10

SPRING LOADED TERMINAL BLOCKS

These modified version of feed through Terminal Blocks are fitted with springs below the clamps. These Terminal Blocks are preferred for connections that involve safety requirements of the Electric Supply Industry (ESI) standards, British CEGB regulations, SEC and NTPC applications. In addition to the high torque screws, these blocks have a built-in spring loading feature.

It is recommended to use hook type lug / ferrule for terminating wires in such connections.

These Terminal Blocks have a specially designed current bar for the right location & placement of wires crimped with hook type lug / ferrule, thus preventing loosening of the wires even when the screw clamps are not tightened.

CTS4USC, CTS6USC & CTS10USC are standard spring loaded feed through Terminal Blocks.

CDS6U/SC is spring loaded disconnect & test Terminal Block suitable for CT, PT & VT circuits.

Width (Thickness) x Length	
Height with DIN 35 x 7.5 / 35 x 15 / 32 mm Rail	
Connection Possibility as per	
With 1 Conductor per clamp	Stranded / Flexible Solid with Ferrule / Lug
With 2 same size Conductors per clamp	Stranded / Flexible with TWIN Ferrule / Lug
Wire Stripping Length	
Ratings As Per	
Voltage	
Current	
Torque	
Approvals	
Insulation Material / Material Group	
Rated Impulse Voltage / Pollution Degree	

CTS4USC



6 x 52 mm			
63.4 mm / 70.8 mm / 68.2 mm			
IEC		UL - CSA	
0.2 - 4.0 mm ²		22 - 10 AWG	
0.2 - 6.0 mm ²			
0.2 - 4.0 mm ²		22 - 10 AWG	
0.2 - 2.5 mm ²		22 - 12 AWG	
0.2 - 2.5 mm ²		22 - 12 AWG	
12 mm			
IEC60947-7-1 UL-1059 CSA22.2-158			
1000 V	600 V	600 V	
32 A	35 A	35 A	
0.5 Nm	7 lb-in	7 lb-in	
Polyamide 6,6 / 1			
8 KV / 3			

Terminal Block	Grey Blue
End Plate	
Separator Plate	
Mounting Rail (Refer Pg. 217 for details)	
End Clamp (Refer Pg. 218 for details)	
Marking Tags (Refer Pg. 222 for details)	
Screw Driver	

Type / Cat. No.	Standard Pack
CTS4USC	50
CTS4USCBU	50
EPUSC	50
SP2.5/4UN	50
CA701-1M / CA701-1M-S	50 m
CA701-15-1M / CA701-15-1M-S	25 m
CA702 / CA802	50
CA509/K6WHT	100
SCS0.6/3.5 Blade size: 0.6 x 3.5 mm	10

Jumpers	
Screw Type Jumpers	2 pole
	3 pole
	4 pole
	10 pole
Hook Type Lug / Ferrule	1.5 sq.mm
	2.5 sq.mm
	4 sq.mm
	6 sq.mm
	10 sq.mm

Type / Cat. No.	I _{max}	Standard Pack
CA623/2	32 A	100
CA623/3	32 A	100
CA623/4	32 A	100
CA623/10	32 A	10
CA604/1		100
CA604/2		100
CA604/5		100

CTS6USC



8 x 52 mm
63.4 mm / 70.8 mm / 68.2 mm

IEC	UL - CSA
0.2 - 6.0 mm ²	22 - 8 AWG
0.2 - 6.0 mm ²	22 - 8 AWG
0.2 - 4.0 mm ²	22 - 10 AWG
0.2 - 4.0 mm ²	22 - 10 AWG

14 mm

IEC60947-7-1 UL-1059 CSA22.2-158

1000 V	1000 V	1000 V
41 A	50 A	50 A
0.8 Nm	14 lb-in	14 lb-in



Polyamide 6,6 / 1

8 KV / 3

Type / Cat. No.	Standard Pack
CTS6USC	50
CTS6USCUB	50
EPUSC	50
SP2.5/4UN	50
CA701-1M / CA701-1M-S	50 m
CA701-15-1M / CA701-15-1M-S	25 m
CA702 / CA802	50
CA509/K6WHT	100
SCS0.6/3.5 Blade size: 0.6 x 3.5 mm	10

CTS10USC



10 x 52 mm
63.4 mm / 70.8 mm / 68.2 mm

IEC	UL - CSA
0.2 - 10.0 mm ²	20 - 6 AWG
0.2 - 10.0 mm ²	20 - 6 AWG
0.2 - 6.0 mm ²	20 - 8 AWG
0.2 - 6.0 mm ²	20 - 8 AWG

14 mm

IEC60947-7-1 UL-1059 CSA22.2-158

1000 V	1000 V	1000 V
57 A	65 A	65 A
1.2 Nm	14 lb-in	14 lb-in



Polyamide 6,6 / 1

8 KV / 3

Type / Cat. No.	Standard Pack
CTS10USC	50
EPUSC	50
SP2.5/4UN	50
CA701-1M / CA701-1M-S	50 m
CA701-15-1M / CA701-15-1M-S	25 m
CA702 / CA802	50
CA509/K10WHT	100
SCS0.8/4 Blade size: 0.8 x 4 mm	10

CDS6U/SC

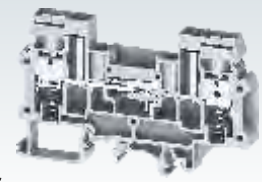

8 x 82 mm
51.0 mm / 59.2 mm / 56.7 mm

IEC	UL - CSA
0.2 - 6.0 mm ²	22 - 8 AWG
0.2 - 6.0 mm ²	22 - 8 AWG
0.2 - 4.0 mm ²	22 - 10 AWG
0.2 - 4.0 mm ²	22 - 10 AWG

10 mm

IEC60947-7-1 UL-1059 CSA22.2-158

800 V	600 V	600 V
41 A	45 A	45 A
0.8 Nm	14 lb-in	14 lb-in



Polyamide 6,6 / 1

8 KV / 3

Type / Cat. No.	Standard Pack
CDS6U/SC	50
EPCDS6U	50
CA701-1M / CA701-1M-S	50 m
CA701-15-1M / CA701-15-1M-S	25 m
CA702 / CA802	50
CA509/K8WHT	100
SCS0.8/4 Blade size: 0.8 x 4 mm	10

Type / Cat. No.	I _{max}	Standard Pack
CA624/2	41 A	100
CA624/3	41 A	100
CA624/4	41 A	100
CA624/10	41 A	10
CA604/1		100
CA604/2		100
CA604/5		100
CA604/3		100

Type / Cat. No.	I _{max}	Standard Pack
CA625/2	57 A	100
CA625/3	57 A	100
CA625/4	57 A	100
CA625/10	57 A	10
CA604/1		100
CA604/2		100
CA604/5		100
CA604/4		100
CA604/3		100

Type / Cat. No.	I _{max}	Standard Pack
CA723/2	41 A	100
CA723/3	41 A	50
CA723/4	41 A	50
CA723/10	41 A	50
CA604/1		100
CA604/2		100
CA604/5		100
CA604/3		100

Note:
For other accessories for CDS6U
please refer page 49.

SPRING LOADED TERMINAL BLOCKS

CKT4SPSC is spring loaded knife disconnect Terminal Block. Disconnection of circuit is achieved by lifting a lever which operates the knife contact.

In CDTTUSC terminal the disconnection is achieved by means of a slide link operated with a screw driver.

CDTTUFTSC is standard spring loaded feed through Terminal Block in the same profile as that of CDTTUSC.

CKT4SPSC

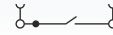

Width (Thickness) x Length	6 x 58.5 mm				
Height with DIN 35 x 7.5 / 35 x 15 / 32 mm Rail	46.0 mm / 53.5 mm / 51.5 mm				
Connection Possibility as per	IEC	UL - CSA			
With 1 Conductor per clamp	Stranded / Flexible	0.2 - 4.0 mm ² / 24 - 10 AWG			
	Solid with Ferrule / Lug	0.2 - 6.0 mm ² / 24 - 10 AWG			
With 2 same size Conductors per clamp	Stranded / Flexible	0.2 - 4.0 mm ² / 24 - 10 AWG			
	with TWIN Ferrule / Lug	0.2 - 2.5 mm ² / 24 - 12 AWG			
Wire Stripping Length	8 mm				
Ratings As Per	IEC60947-7-1	UL-1059	CSA22.2-158		
Voltage	1000 V	600 V	600 V		
Current	28 A	30 A	30 A		
Torque	0.5 Nm	4.5 lb-in	4.5 lb-in		
Approvals					
Insulation Material / Material Group	Polyamide 6,6 / 1				
Rated Impulse Voltage / Pollution Degree	8 KV / 3				
	Type / Cat. No.	Standard Pack			
Terminal Block	CKT4SPSC	50			
Mounting Rail (Refer Pg. 217 for details)	CA701-1M / CA701-1M-S	50 m			
	CA701-15-1M / CA701-15-1M-S	25 m			
End Clamp (Refer Pg. 218 for details)	CA702 / CA802	50			
Marking Tags (Refer Pg. 222 for details)	CA509/K6WHT	100			
Screw Driver	SCS0.6/3.5 Blade size: 0.6 x 3.5 mm	10			
Jumpers	Uninsulated	Insulated	Imax	Standard Pack	
Screw Type Jumpers	2 pole	CA722/2	CA742/2	28 A	100
	3 pole	CA722/3	CA742/3	28 A	100
	4 pole	CA722/4	CA742/4	28 A	100
	10 pole	CA722/10	CA742/10	28 A	10
External Jumpers	2 pole		CA714/2	28 A	100
	3 pole		CA714/3	28 A	100
	4 pole		CA714/4	28 A	100
	10 pole		CA714/10	28 A	20
Shorting Plug					

CDTTUSC

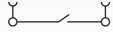

8 x 63 mm

58.7 mm / 65.7 mm / 63.7 mm

IEC	UL - CSA
1.5 - 10.0 mm ²	16 - 8 AWG
1.5 - 10.0 mm ²	16 - 8 AWG
1.5 - 4.0 mm ²	16 - 10 AWG
1.5 - 4.0 mm ²	16 - 10 AWG

12 mm

IEC60947-7-1 UL-1059 CSA22.2-158

800 V	600 V	600 V
57 A	41 A	41 A
1.2 Nm	14 lb-in	14 lb-in



Polyamide 6,6 / 1

8 KV / 3

Type / Cat. No.	Standard Pack
CDTTUSC	50
EPCDTTU	50
CA701-1M / CA701-1M-S	50 m
CA701-15-1M / CA701-15-1M-S	25 m
CA702 / CA802	50
CA509/K8WHT	100
SCS1.0/5.5 Blade size: 1.0 x 5.5 mm	10

Type / Cat. No.	I _{max}	Standard Pack
CA710/2	35 A	100
CA710/3	35 A	50
CA710/4	35 A	50
CA710/10	35 A	20
QJ8/2		25

CDTTUFTSC



8 x 63 mm

58.7 mm / 65.7 mm / 63.7 mm

IEC	UL - CSA
1.5 - 10.0 mm ²	16 - 8 AWG
1.5 - 10.0 mm ²	16 - 8 AWG
1.5 - 4.0 mm ²	16 - 10 AWG
1.5 - 4.0 mm ²	16 - 10 AWG

12 mm

IEC60947-7-1 UL-1059 CSA22.2-158

800 V	600 V	600 V
57 A	41 A	41 A
1.2 Nm	14 lb-in	14 lb-in



Polyamide 6,6 / 1

8 KV / 3







Type / Cat. No.	Standard Pack
CDTTUFTSC	50
EPCDTTU	50
CA701-1M / CA701-1M-S	50 m
CA701-15-1M / CA701-15-1M-S	25 m
CA702 / CA802	50
CA509/K8WHT	100
SCS1.0/5.5 Blade size: 1.0 x 5.5 mm	10

Type / Cat. No.	I _{max}	Standard Pack
CA710/2	35 A	100
CA710/3	35 A	50
CA710/4	35 A	50
CA710/10	35 A	20

MICRO TERMINAL BLOCKS







These Terminal Blocks are extremely compact and are used in applications with space constraints. These blocks should be used with DIN 15 type (DIN 2) rails.

The terminals with  & IECEx approval can be used in potentially explosive atmosphere. For detailed information refer page 243.

Width (Thickness) x Length		6 x 27 mm			
Height with DIN 15 mm Rail		30.4 mm			
Connection Possibility as per		IEC		UL - CSA	
With 1 Conductor per clamp	Stranded / Flexible	0.2 - 4.0 mm ²	22 - 10 AWG		
	Solid with Ferrule / Lug	0.2 - 6.0 mm ²			
With 2 same size Conductors per clamp	Stranded / Flexible	0.2 - 4.0 mm ²	22 - 10 AWG		
	with TWIN Ferrule / Lug	0.2 - 2.5 mm ²	22 - 12 AWG		
Wire Stripping Length		8 mm			
Ratings As Per		IEC60947-7-1	UL-1059	CSA22.2-158	IEC 60079-7
Voltage		500 V	300 V	300 V	380 V
Current		32 A	35 A	35 A	28 A
Torque		0.5 Nm	7 lb-in	7 lb-in	0.5 Nm
Approvals					
Insulation Material / Material Group		Polyamide 6,6 / 1			
Rated Impulse Voltage / Pollution Degree		4 KV / 3			
		Type / Cat. No.		Standard Pack	
Terminal Block	Grey	CMT4		100	
	Blue	CMT4BU		100	
	Red	CMT4R		100	
	Yellow	CMT4Y		100	
	Black	CMT4BK		100	
	Green	CMT4GN		100	
	Ground / Earth (Refer Pg. 28 for Details)		CGMT4		100
End Plate 		EPCMT4		50	
Partition Plate 		PPCMT4		50	
Mounting Rail (Refer Pg. 217 for details) 		CA601		50	
End Clamp (Refer Pg. 218 for details) 		CA602		50	
Marking Tags (Refer Pg. 222 for details) 		CA509/K2WHT		100	
Screw Driver 		SCS0.6/3.5 Blade size: 0.6 x 3.5 mm		10	

CMT4









Jumpers		Uninsulated	Insulated	Imax	Standard Pack
Screw Type Jumpers 	2 pole	CA727/2	CA747/2	32 A	100
	3 pole	CA727/3	CA747/3	32 A	100
	4 pole	CA727/4	CA747/4	32 A	100
	10 pole	CA727/10	CA747/10	32 A	10
	100 pole				
Jumper Bar 	2 pole	CA703/1		32 A	100
	3 pole	CA704/1		32 A	100
	4 pole	CA705/1		32 A	100
	10 pole	CA732/10		32 A	100
	10 pole (Breakable)	CA732/10-A		32 A	100
	100 pole	CA732/100		32 A	10
Short Sleeve & Screw for configurable jumper bar 		CA607/S/Q		100	
Switchable Jumpers 		CA706/1		32 A	100
Long Sleeve & Screw for Switchable Jumpers 		CA607/L/Q		100	
External Jumpers 	2 pole		CA714/2	25 A	100
	3 pole		CA714/3	25 A	100
	4 pole		CA714/4	25 A	100
	10 pole		CA714/10	25 A	20
Test Socket 		CA707/TS/03		100	

PANEL MOUNT TERMINAL BLOCK

A perfect solution for extremely compact wiring applications, these Terminal Blocks are modular and can be stacked to form multi-pole Terminal Block assemblies. The stacked assemblies are fitted with mounting End Plates on both ends for easy installations.

M3 screw of desired length can be used for mounting.

The terminals with  & IECEx approval can be used in potentially explosive atmosphere. For detailed information refer page 243.



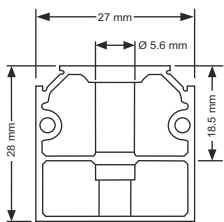

Width (Thickness) x Length		6 x 27 mm			
Height		28.5 mm			
Connection Possibility as per		IEC		UL - CSA	
With 1 Conductor per clamp	Stranded / Flexible	0.2 - 4.0 mm ²	22 - 10 AWG		
	Solid with Ferrule / Lug	0.2 - 6.0 mm ²			
With 2 same size Conductors per clamp	Stranded / Flexible	0.2 - 4.0 mm ²	22 - 10 AWG		
	with TWIN Ferrule / Lug	0.2 - 2.5 mm ²	22 - 12 AWG		
Wire Stripping Length		8 mm			
Ratings As Per		IEC60947-7-1	UL-1059	CSA22.2-158	IEC 60079-7
Voltage		500 V	300 V	300 V	440 V
Current		32 A	30 A	35 A	28 A
Torque		0.5 Nm	7 lb-in	7 lb-in	0.5 Nm
Approvals					
Insulation Material / Material Group		Polyamide 6,6 / 1			
Rated Impulse Voltage / Pollution Degree		4 KV / 3			
		Type / Cat. No.		Standard Pack	
Terminal Block	Grey	CMB4	100		
	Blue	CMB4BU	100		
	Red	CMB4R	100		
	Yellow	CMB4Y	100		
	Black	CMB4BK	100		
	Green	CMB4GN	100		
	Orange	CMB4O	100		
	White	CMB4W	100		
End Plate		EPCMB4	50		
Separator Plate		SPCMB4	50		
Marking Tags (Refer Pg. 222 for details)		CA509/K2WHT	100		
Screw Driver		SCS0.6/3.5	Blade size: 0.6 x 3.5 mm		10

Note: It is recommended to use additional End Plate after every 20 Terminal Blocks in a stacked assembly.

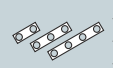

End Plate



Jumpers						
Screw Type Jumpers		2 pole	CA727/2	CA747/2	32 A	100
		3 pole	CA727/3	CA747/3	32 A	100
		4 pole	CA727/4	CA747/4	32 A	100
		10 pole	CA727/10	CA747/10	32 A	10
		100 pole				
Jumper Bar		2 pole	CA703/1		32 A	100
		3 pole	CA704/1		32 A	100
		4 pole	CA705/1		32 A	100
		10 pole	CA732/10		32 A	100
		10 pole (Breakable)	CA732/10-A		32 A	100
		100 pole	CA732/100		32 A	10
Short Sleeve & Screw for configurable jumper bar			CA607/S/Q			100
External Jumpers		2 pole		CA714/2	25 A	100
		3 pole		CA714/3	25 A	100
		4 pole		CA714/4	25 A	100
		10 pole		CA714/10	25 A	20
Test Socket			CA707/TS/01			100

THERMOCOUPLE TERMINAL BLOCKS

These Terminal Blocks are used with thermocouple wires in measurement applications.

As per DIN 43713 & DIN 43714 the current carrying element of the Terminal Block is made of the same material as the Thermocouple wire. These special current carrying elements ensure that there is no loss of potential at the connecting points.

The following types of Thermocouple wires can be connected using standard Thermocouple Terminal Blocks

'K' type - Chromel (Ni/Cr), Alumel (Ni/Al)

'J' type - Iron (Fe), Constantan (Cu/Ni)

'T' type - Copper (Cu), Constantan (Cu/Ni)

'E' type - Chromel (Ni/Cr), Constantan (Cu/Ni)

CTT2.5U



Width (Thickness) x Length	10 x 43 mm		
Height with DIN 35 x 7.5 / 35 x 15 / 32 mm Rail	46.2 mm / 53.7 mm / 51.1 mm		
Connection Possibility as per	IEC	UL - CSA	
With 1 Conductor per clamp	Stranded / Flexible	0.2 - 2.5 mm ²	22 - 14 AWG
	Solid	0.2 - 4.0 mm ²	22 - 12 AWG
	with Ferrule / Lug	0.2 - 2.5 mm ²	22 - 14 AWG
With 2 same size Conductors per clamp	Stranded / Flexible	0.2 - 1.5 mm ²	22 - 16 AWG
	with TWIN Ferrule / Lug	0.2 - 1.5 mm ²	22 - 16 AWG
Wire Stripping Length	8 mm		
Ratings As Per	IEC60947-7-1		
Voltage	1000 V		
Current	10 A		
Torque	0.4 Nm		
Approvals			
Insulation Material / Material Group	Polyamide 6,6 / 1		
Rated Impulse Voltage / Pollution Degree	4 KV / 3		
Terminal Block	Type / Cat. No.	Suitable for Thermocouple Wire	Standard Pack
	CTT2.5UK	K Type	50
	CTT2.5UJ	J Type	50
	CTT2.5UT	T Type	50
	CTT2.5UE	E Type	50
End Plate	EP2.5/4UN		50
Partition Plate	PP2.5/4UN		50
Separator Plate	SP2.5/4UN		100
Mounting Rail (Refer Pg. 217 for details)	CA701-1M / CA701-1M-S		50 m
	CA701-15-1M / CA701-15-1M-S		25 m
End Clamp (Refer Pg. 218 for details)	CA702 / CA802		50
Marking Tags (Refer Pg. 222 for details)	CA509/K5WHT		100
Screw Driver	SCS0.5/3	Blade size: 0.5 x 3.0 mm	10

Typical Temperature Measuring circuit

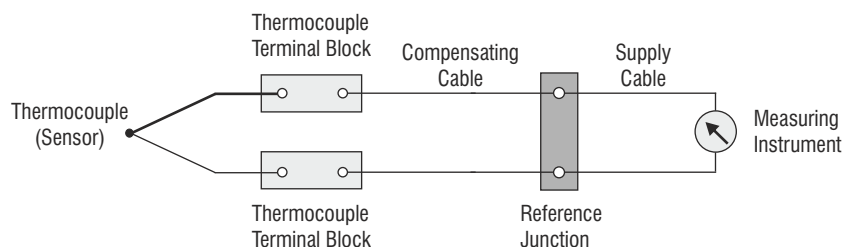

TAB CONNECTION TERMINAL BLOCKS

The CTC4U Tab Connection Terminal Blocks offer quick connection possibility. The Terminal Blocks are suited for standard 'Fast On' type lugs.

The connection is achieved by pushing the lug / ferrule onto the tab blade of the Terminal Block.



CTC4U

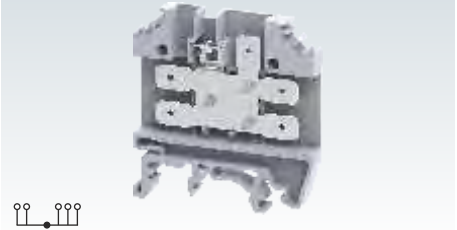

Width (Thickness) x Length	6 x 47 mm			
Height with DIN 35 x 7.5 / 35 x 15 / 32 mm Rail	51.2 mm / 58.8 mm / 56.3 mm			
Connection Possibility as per	IEC	UL - CSA		
With 1 Conductor per clamp	Stranded / Flexible with Ferrule / Lug	0.2 - 4.0 mm ²	24 - 12 AWG	
With 2 same size Conductors per clamp	Stranded / Flexible	0.2 - 2.5 mm ²	24 - 12 AWG	
Wire Stripping Length	9 mm			
Ratings As Per	IEC60947-7-1			
Voltage	300 V			
Current	32 A			
Approvals				
Insulation Material / Material Group	Polyamide 6,6 / 1			
Rated Impulse Voltage / Pollution Degree	2.5 KV / 3			
Terminal Block	Type / Cat. No.	Standard Pack		
Terminal Block	CTC4U	100		
End Plate	EPCTC4U	50		
Mounting Rail (Refer Pg. 217 for details)	CA701-1M / CA701-1M-S	50 m		
End Clamp (Refer Pg. 218 for details)	CA701-15-1M / CA701-15-1M-S	25 m		
Marking Tags (Refer Pg. 222 for details)	CA702 / CA802	50		
	CA509/K6WHT	100		
Jumpers		I_{max}	Standard Pack	
Permanent Jumpers	2 pole	CA703/1	32 A	100
	3 pole	CA704/1	32 A	100
	4 pole	CA705/1	32 A	100
	10 pole	CA732/10	32 A	100
	100 pole	CA732/100	32 A	10
Short Sleeve & Screw for Permanent Jumpers		CA807/S/Q/01		100
Test Socket		CA707/TS/01		100



TERMINAL BLOCKS WITH ELECTRONIC COMPONENTS

The following Standard Active Terminal Blocks are available:

Diode / Resistor Terminal Blocks

Terminal Blocks with Light Indication

CDL4U(O) - Connectwell Double Level Terminal Blocks are available with open current bars at the bottom level to which the electronic components can be soldered.

CDL4USP - Spacers can be used for covering custom electronic components, which may protrude from the CDL4U(O) Terminal Block.

Width (Thickness) x Length	6 x 55.5 mm		
Height with DIN 35 x 7.5 / 35 x 15 / 32 mm Rail	55.7 mm / 63.1 mm / 60.3 mm		
Connection Possibility as per	IEC	UL - CSA	
With 1 Conductor per clamp	Stranded / Flexible	0.2 - 4.0 mm ²	22 - 10 AWG
	Solid	0.2 - 6.0 mm ²	
With 2 same size Conductors per clamp	with Ferrule / Lug	0.2 - 4.0 mm ²	22 - 10 AWG
	Stranded / Flexible	0.2 - 2.5 mm ²	22 - 12 AWG
Wire Stripping Length	with TWIN Ferrule / Lug	0.2 - 2.5 mm ²	22 - 12 AWG
		9 mm	
Ratings As Per	IEC60947-7-1	UL-1059	CSA22.2-158
Voltage	500 V	600 V	300 V
Current	32 A	35 A	25 A
Torque	0.5 Nm	7 lb-in	7 lb-in
Approvals			
Insulation Material / Material Group	Polyamide 6,6 / 1		
Diode	1N 4007		
Diode Reverse Voltage / Current	1000 V / 1 A		

	Type / Cat. No.	Standard Pack
End Plate	EPCDL4U	50
Spacer	CDL4USP	50
Mounting Rail (Refer Pg. 217 for details)	CA701-1M / CA701-1M-S	50 m
	CA701-15-1M / CA701-15-1M-S	25 m
Marking Tags (Refer Pg. 222 for details)	CA509/K2WHT	100
Screw Driver	SCS0.6/3.5 Blade size: 0.6 x 3.5 mm	10

	Type / Cat. No.	Imax	Standard Pack
Screw Type Jumpers	2 pole	CA703/1	32 A
	3 pole	CA704/1	32 A
	4 pole	CA705/1	32 A
	10 pole	CA732/10	32 A
Short Sleeve & Screw for configurable jumper bar	CA607/S/Q		100

Part No.	Application	Std. Pack
CDL4UED1	Arc suppression circuit for contactors & solenoid valves - D.C	100

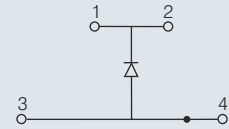

Part No.	Application	Std. Pack
CDL4UED2	Arc suppression circuit for contactors & solenoid valves - D.C	100

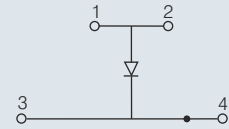
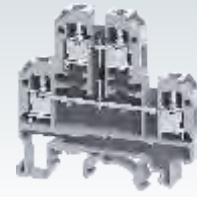

Part No.	Application	Std. Pack
CDL4UED3	Diode circuit for reverse polarity protection	100

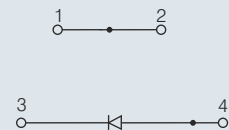

Part No.	Application	Std. Pack
CDL4UEDD1	Diode circuit for lamp testing	100

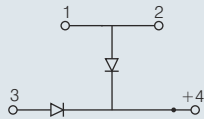

Part No.	Application	Std. Pack
CDL4UEDD2	Diode circuit for lamp testing	100

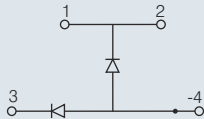

Part No.	Application	Std. Pack
CDL4UEDD3	Diode circuit for lamp testing	100

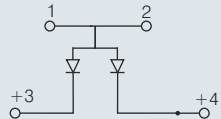

Part No.	Application	Std. Pack
CDL4UEDD4	Diode circuit for lamp testing	100

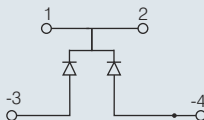

Part No.	Application	Std. Pack
CDL4UED4	Diode circuit for lamp testing with LED series resistance	100

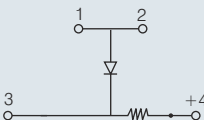

Part No.	Application	Std. Pack
CDL4UEDD5	Diode circuit for lamp testing with LED series resistance	100

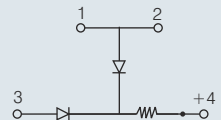

Part No.	Application	Std. Pack
CKT4UD1	Arc suppression circuit for contactors & solenoid valves - D.C	100



Part No.	Application	Std. Pack
CKT4UD2	Arc suppression circuit for contactors & solenoid valves - D.C	100



Part No.	Diode Type	Std. Pack
CF4SPD1	1N4007	50
CF4SPD2	1N5408	50
CF4SPD3	1N5820	50

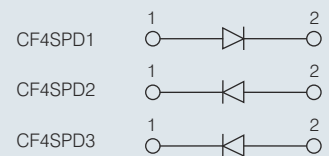
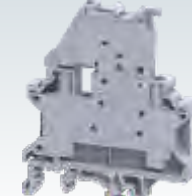

Part No.	Application	Std. Pack
CDL4UEN1	AC Voltage indicator with Neon lamp	100

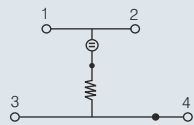

Part No.	Application	Std. Pack
CDL4UELD5	AC Voltage indicator with LED	100

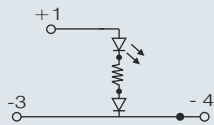

Part No.	Application	Std. Pack
CDL4UELD3	AC Voltage indicator with LED	100

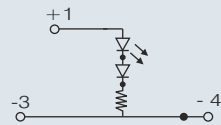
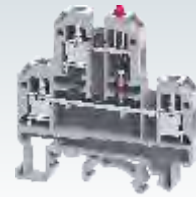

Part No.	Application	Std. Pack
CDL4UELD4	AC Voltage indicator with LED	100

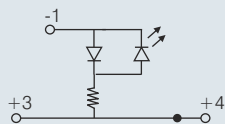

Part No.	Application	Std. Pack
CDL4UELD1	DC Voltage indicator with LED	100

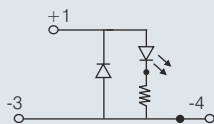

Part No.	Application	Std. Pack
CDL4UELD2	DC Voltage indicator with LED	100

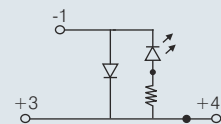
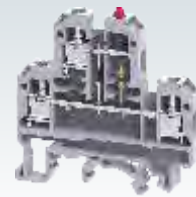

Part No.	Application	Std. Pack
CDL4UEL1	DC Voltage indicator with LED	100

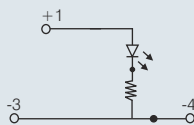

Part No.	Application	Std. Pack
CDL4UEL2	DC Voltage indicator with LED	100

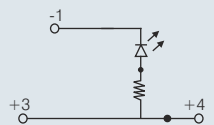

Part No.	Application	Std. Pack
CDL4U(O)	Basic terminal for soldering electronic components	100

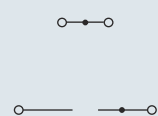

SURGE SUPPRESSION TERMINAL BLOCKS

These Terminal Blocks are designed to protect a single line against a longitudinal (line / earth) surge, thereby protecting distribution and input.

CDL4U(E)SDU is for DC application at 48 V with current rating 3.2 A.



CDL4U(E)SDB is for AC application at 400 VAC with current rating 4 A.

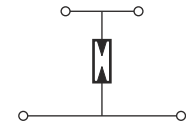





Circuit Diagram



CDL4UELA



Width (Thickness) x Length	18 x 55.5 mm	
Height with DIN 35 x 7.5 / 35 x 15 / 32 mm Rail	55.7 mm / 63.1 mm / 60.3 mm	
Connection Possibility as per	IEC	UL - CSA
With 1 Conductor per clamp	Stranded / Flexible	0.2 - 4.0 mm ²
	Solid	0.2 - 6.0 mm ²
With 2 same size Conductors per clamp	with Ferrule / Lug	0.2 - 4.0 mm ²
	Stranded / Flexible	0.2 - 2.5 mm ²
	with TWIN Ferrule / Lug	0.2 - 2.5 mm ²
		22 - 10 AWG
Wire Stripping Length	9 mm	
Type of Connection	4 Screw Clamps	
Rated Connection Capacity	0.5 - 4 sq.mm / 22-10 AWG	
Voltage Rating	75 V, 90 V, 230 V, 600 V, 1000 V DC	
Impulse Discharge Current	20 KA (8/20 μ s)	
Alternating Discharge Current at Hz	20 A	
Response Time	100 ms	
Normal Current	10 A	
Capacitance	< 1.5 pf	
Insulation Material / Material Group	Polyamide 6,6 / 1	
Approvals	 	

	Type / Cat. No.	Standard Pack
Terminal Block	CDL4UELA90V	32
End Plate 	EPCDL4U	50
Spacer 	CDL4USP	50
Mounting Rail (Refer Pg. 217 for details) 	CA701-1M / CA701-1M-S	50 m
	CA701-15-1M / CA701-15-1M-S	25 m
End Clamp (Refer Pg. 218 for details) 	CA702 / CA802 / CA202	50
Marking Tags (Refer Pg. 222 for details) 	CA509/K2WHT	100
Screw Driver 	SCS0.6/3.5 Blade size: 0.6 x 3.5 mm	10

SURGE SUPPRESSION TERMINAL BLOCKS

CDL4UE3LA

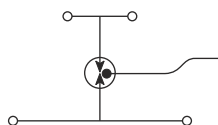

Circuit Diagram

CDL4UEMOV

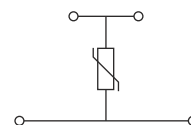

Width (Thickness) x Length	18 x 55.5 mm		12 x 55.5 mm	
Height with DIN 35 x 7.5 / 35 x 15 / 32 mm Rail	55.7 mm / 63.1 mm / 60.3 mm		55.7 mm / 63.1 mm / 60.3 mm	
Connection Possibility as per	IEC	UL - CSA	IEC	UL - CSA
	With 1 Conductor per clamp	Stranded / Flexible 0.2 - 4.0 mm ² Solid 0.2 - 6.0 mm ² with Ferrule / Lug 0.2 - 4.0 mm ²	22 - 10 AWG	0.2 - 4.0 mm ² 0.2 - 6.0 mm ² 0.2 - 4.0 mm ²
With 2 same size Conductors per clamp	Stranded / Flexible 0.2 - 2.5 mm ² with TWIN Ferrule / Lug 0.2 - 2.5 mm ²	22 - 12 AWG	0.2 - 2.5 mm ² 0.2 - 2.5 mm ²	22 - 12 AWG
Wire Stripping Length	9 mm		9 mm	
Type of Connection	4 Screw Clamps		4 Screw Clamps	
Rated Connection Capacity	0.5 - 4 sq.mm / 22-10 AWG		0.5 - 4 sq.mm / 22-10 AWG	
Voltage Rating	90 V, 230 V, 350 V, 600 V DC		30 V, 60 V, 75 V, 130 V, 275 V, 460 V, 510 V, 625 V, 680 V A.C.	
Impulse Discharge Current	10 KA (8/20μs)		2 KA - 6.5 KA (8/20μs)	
Alternating Discharge Current at Hz	10 A			
Response Time	100 ms		< 25 ns	
Capacitance	< 1.0 pf		100 - 20000 pf	
Insulation Material / Material Group	Polyamide 6,6 / 1		Polyamide 6,6 / 1	
Approvals				
	Type / Cat. No.	Standard Pack	Type / Cat. No.	Standard Pack
Terminal Block	CDL4UE3LA(90V)	32	CDL4UEMOV-30V CDL4UEMOV-60V	52 52
End Plate	EPCDL4U	50	EPCDL4U	50
Spacer	CDL4USP	50	CDL4USP	50
Mounting Rail (Refer Pg. 217 for details)	CA701-1M / CA701-1M-S	50 m	CA701-1M / CA701-1M-S	50 m
	CA701-15-1M / CA701-15-1M-S	25 m	CA701-15-1M / CA701-15-1M-S	25 m
End Clamp (Refer Pg. 218 for details)	CA702 / CA802 / CA202	50	CA702 / CA802 / CA202	50
Marking Tags (Refer Pg. 222 for details)	CA509/K2WHT	100	CA509/K2WHT	100
Screw Driver	SCS0.6/3.5 Blade size: 0.6 x 3.5 mm	10	SCS0.6/3.5 Blade size: 0.6 x 3.5 mm	10

CTLG2.5EMOV

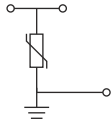

6 x 87.5 mm

66.0 mm / 74.0 mm

IEC	UL - CSA
0.2 - 2.5 mm ²	22 - 14 AWG
0.2 - 4.0 mm ²	22 - 12 AWG
0.2 - 2.5 mm ²	22 - 14 AWG
0.2 - 1.5 mm ²	22 - 16 AWG
0.2 - 1.5 mm ²	22 - 16 AWG

9 mm

3 Screw Clamps

0.5 - 2.5 sq.mm / 22-12 AWG

Upto 275 V

2 KA - 6.5 KA (8/20μs)

< 25 ns

100 - 20000 pf

Polyamide 6,6 / 1



Type / Cat. No.	Standard Pack
CTLG2.5EMOV-275V	50
EPCTLG2.5	50
CA701-1M / CA701-1M-S	50 m
CA701-15-1M / CA701-15-1M-S	25 m
CA702 / CA802 / CA202	50
CA509/K2GWHT	100
SCS0.6/3.5 Blade size: 0.6 x 3.5 mm	10

CDL4UESD

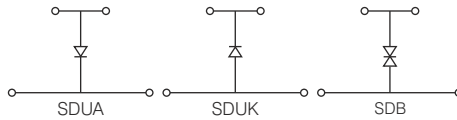

12 x 55.5 mm

55.7 mm / 63.1 mm / 60.3 mm

IEC	UL - CSA
0.2 - 4.0 mm ²	22 - 10 AWG
0.2 - 6.0 mm ²	
0.2 - 4.0 mm ²	22 - 10 AWG
0.2 - 2.5 mm ²	22 - 12 AWG
0.2 - 2.5 mm ²	22 - 12 AWG

9 mm

4 Screw Clamps

0.5 - 4 sq.mm / 22-10 AWG

12 VDC to 48 VDC / 12 VAC to 160 VAC

1.5 KA

1 ns (D.C) / 5 ns (A.C)

Polyamide 6,6 / 1



Type / Cat. No.	Standard Pack
CDL4UESDUA24V	52
CDL4UESDB-160V	52
EPCDL4U	50
CDL4USP	50
CA701-1M / CA701-1M-S	50 m
CA701-15-1M / CA701-15-1M-S	25 m
CA702 / CA802 / CA202	50
CA509/K2WHT	100
SCS0.6/3.5 Blade size: 0.6 x 3.5 mm	10

CDL4UERC

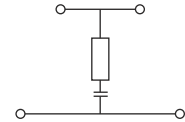

18 x 55.5 mm

55.7 mm / 63.1 mm / 60.3 mm

IEC	UL - CSA
0.2 - 4.0 mm ²	22 - 10 AWG
0.2 - 6.0 mm ²	
0.2 - 4.0 mm ²	22 - 10 AWG
0.2 - 2.5 mm ²	22 - 12 AWG
0.2 - 2.5 mm ²	22 - 12 AWG

9 mm

4 Screw Clamps

0.5 - 4 sq.mm / 22-10 AWG

250 VAC / 630 VDC

20 A

Polyamide 6,6 / 1



Type / Cat. No.	Standard Pack
CDL4UERC0-0.1MF	32
CDL4UERC0.22MF	32
EPCDL4U	50
CDL4USP	50
CA701-1M / CA701-1M-S	50 m
CA701-15-1M / CA701-15-1M-S	25 m
CA702 / CA802 / CA202	50
CA509/K2WHT	100
SCS0.6/3.5 Blade size: 0.6 x 3.5 mm	10

CY SERIES SCREW CLAMP TERMINAL BLOCKS

These next generation Terminal Blocks use the proven & robust Connectwell screw clamp system for the most stringent application requirements. The CY series terminals offer various advantages to the user which includes pluggable jumpers, unified and minimal accessory requirements and ability to affix marking tags on the top surface.

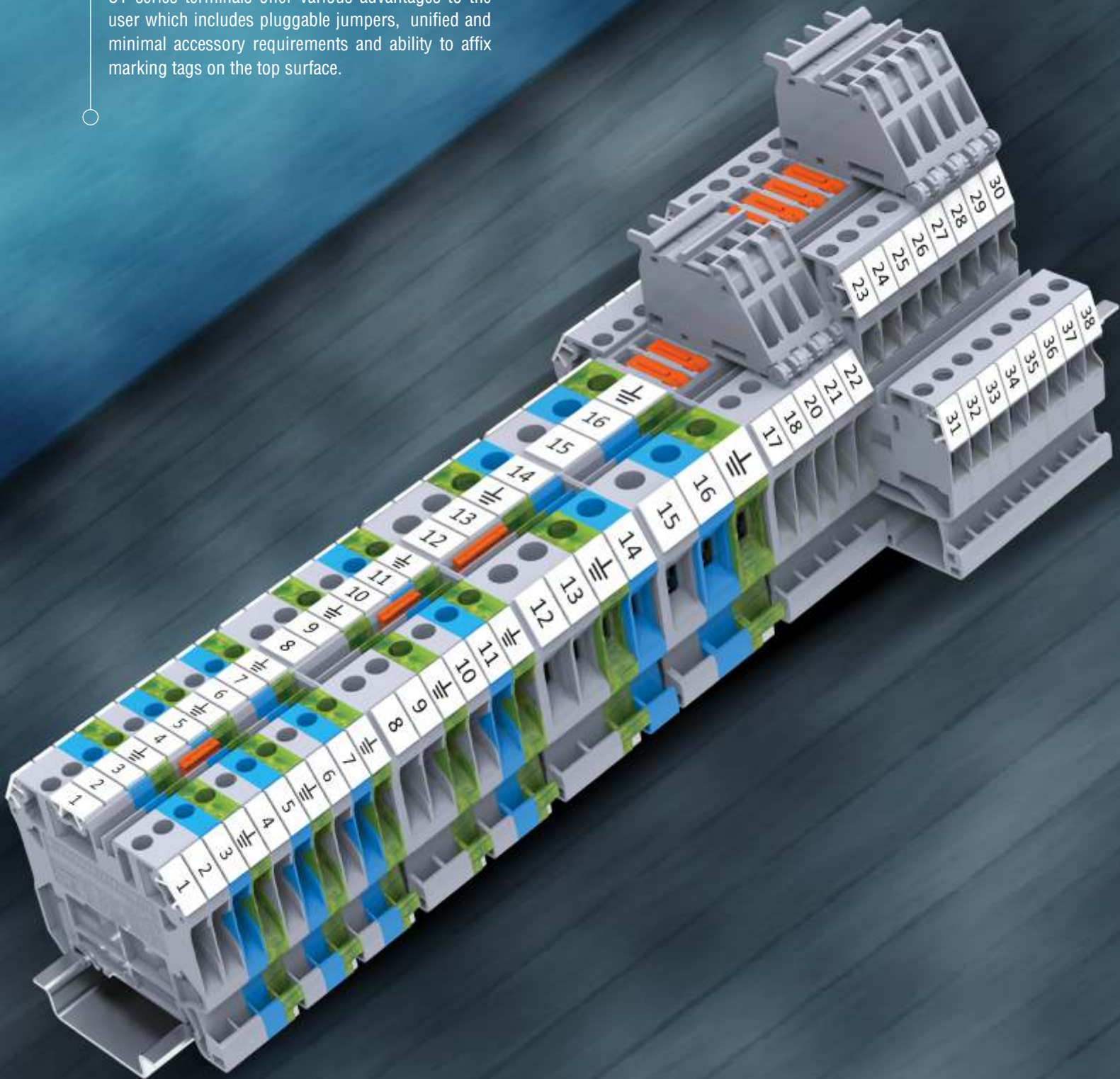

CY SERIES SCREW CLAMP TERMINAL BLOCKS



Feed Through

77 - 78



Ground / Earth

79 - 80



Multiple Connection

81 - 82



Multiple Level

83 - 86



Fuse Terminal

87 - 88



Disconnect & Test

89 - 90

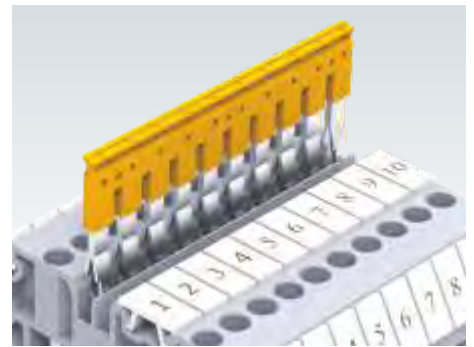
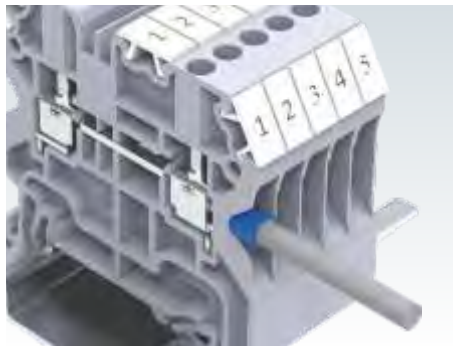

New CY series Terminal Blocks use the proven and robust Connectwell Screw Clamp system. A wide range of feed through terminals are available for wire sizes ranging from 0.2mm² to 10 mm².

A unique design in the plastic housing of the Terminal Block facilitates ease of wire entry. Wires can be used with or without ferrules/Lugs.

Easy to use push in jumpers for shorting Terminal Blocks are now available in 2,3,4, & 10 pole configuration

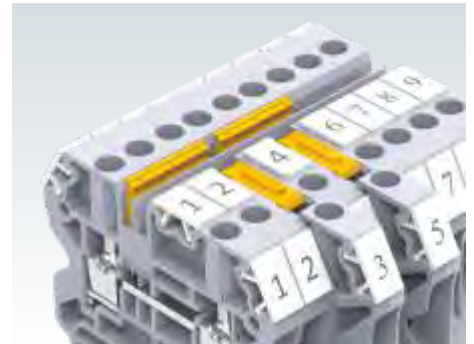
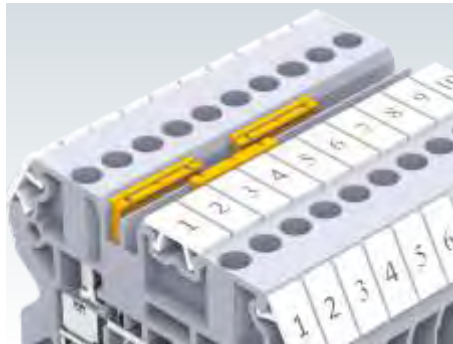
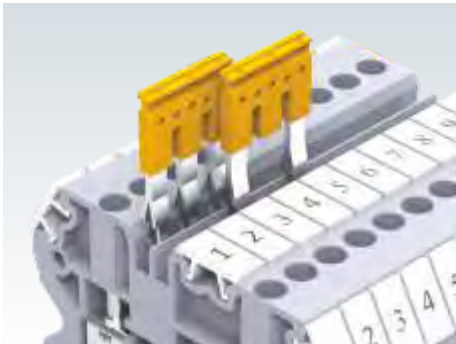

Specific Terminal Blocks in an assembly can be shorted by breaking intermediate contacts from the standard jumpers.

The possibility of using 2 independent rows for bridging enables the creation of various circuit combinations. Jumpers can be marked with a felt tip pen on the recess provided on top, to clearly indicate shorted positions.

The jumper and marking tag position is aligned across different types of CY series Terminal Blocks. This facilitates shorting and marking adjacent terminals with different functionalities.

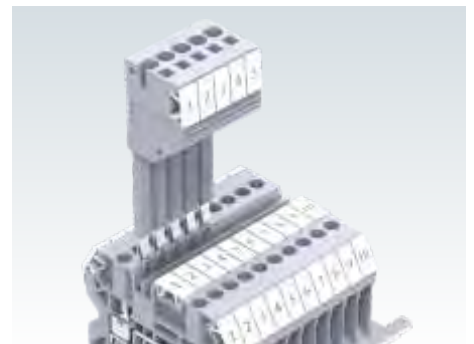
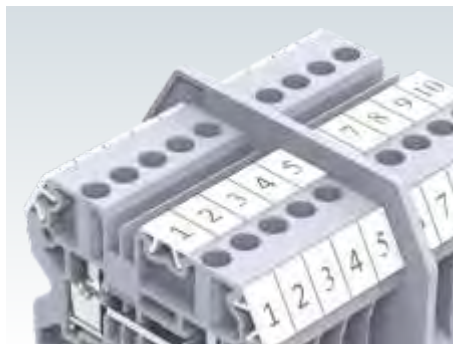

Feed through Terminal Blocks can be simultaneously shorted in an alternating configuration with fuse & Disconnecting Terminal Blocks using pluggable jumpers.

Partition Plates can be individually mounted on Din rails between Terminals Blocks to provide electrical and visual separation.

Specially designed Test Plugs are available for CY series Terminal Blocks for quick testing and measurement.



A high torque clamping system on the screw clamp Terminal Blocks ensures safe, gas tight connections. While cold forged, rolled threaded screws ensure highly reliable connections. Standard feed through are of same dimensions with difference in thickness.



A single end plate can be used for a wide range of feed through terminals.



Same profile grounding terminals are clearly identified with a green-yellow housing. Their shape and thickness is identical to the Feed Trough Terminal Blocks



Multi connection Terminal Blocks are used for applications involving more than one same potential wires to be connected.

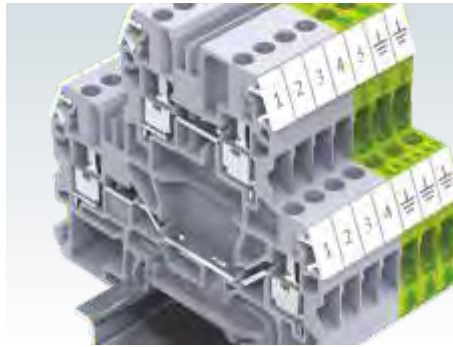

Double level Terminal Blocks enable high density wiring. Each Level can be independently shorted to suit various applications. These Terminal Blocks are an ideal choice for space saving applications.

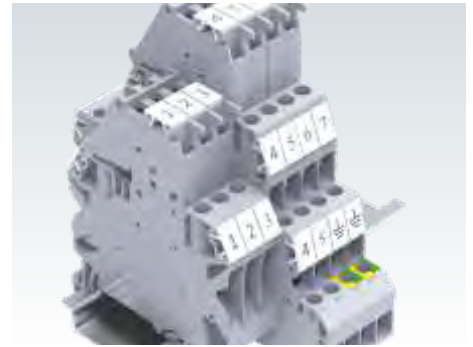

These Fuse Terminal Blocks can be used for $\varnothing 5 \times 20$ and $\varnothing 5 \times 25$ cartridge fuses.

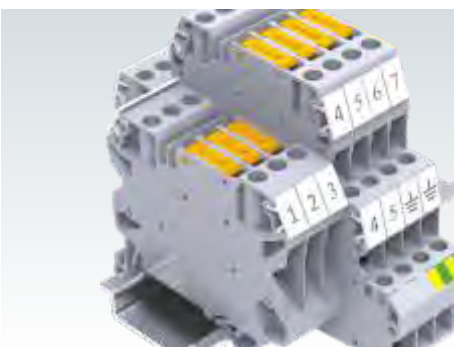

The Screw clamp knife disconnect terminal system enables isolation of circuits. A standard test plug can be used with these Terminal Blocks.

FEED THROUGH TERMINAL BLOCKS

CY series screw clamp Terminal Blocks are the next generation terminals with an improved 1000 V rating as per IEC guidelines. Feed through terminals of different wire sizes have the same outer profile.

Cross connection of these Terminal Blocks can be done using insulated pluggable jumpers, available in various pole configurations.

CY2.5

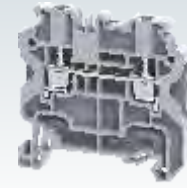

Width (Thickness) x Length	5 x 50 mm					
Height with DIN 35 x 7.5 / 35 x 15 mm Rail	49 mm / 56.5 mm					
Connection Possibility as per	IEC		UL - CSA			
With 1 Conductor per clamp	Stranded / Flexible Solid with Ferrule / Lug	0.2 - 2.5 mm ²	24 - 14 AWG			
		0.2 - 4.0 mm ²	24 - 12 AWG			
		0.2 - 2.5 mm ²	24 - 14 AWG			
With 2 same size Conductors per clamp	with TWIN Ferrule / Lug	0.5 - 1.5 mm ²	20 - 16 AWG			
Wire Stripping Length	8 mm					
Ratings As Per	IEC60947-7-1	UL-1059	CSA22.2-158	IEC60079-7		
Voltage	1000 V	600 V	600 V	630 V		
Current	24 A	20 A	20 A	21 A		
Torque	0.4 Nm	4.5 lb.in	4.5 lb.in	0.4 Nm		
Approval						
Insulation Material / Material Group	Polyamide 6,6 / 1					
Rated Impulse Voltage / Pollution Degree	8 KV / 3					
	Type / Cat. No.		Standard Pack			
Terminal Block	Grey	CY2.5	100			
	Blue	CY2.5BU	100			
	Ground / Earth	CYG2.5 (Refer Pg. 79 for details)	100			
End Plate		EPCY2.5/10	50			
Partition Plate		PPCY2.5/10	20			
Mounting Rail (Refer Pg. 217 for details)		CA701-1M / CA701-1M-S	50 m			
		CA701-15-1M / CA701-15-1M-S	25 m			
End Clamp (Refer Pg. 218 for details)		CA702 / CA802 / CA103	50			
Test Plug		TX2.5	20			
Marking Tags (Refer Pg. 222 for details)		CA509/K5WHT	100			
Screw Driver		SCS0.5/3	Blade size: 0.5 x 3.0 mm	10		
	Type / Cat. No.		Imax	Standard Pack		
Pluggable Jumpers		2 pole	JX2.5/2	24 A	100	
		3 pole	JX2.5/3	24 A	50	
		4 pole	JX2.5/4	24 A	50	
		5 pole	JX2.5/5	24 A	50	
		6 pole	JX2.5/6	24 A	10	
		7 pole	JX2.5/7	24 A	10	
		8 pole	JX2.5/8	24 A	10	
		10 pole	JX2.5/10	24 A	10	
		Step Down Jumpers				

CY4



6 x 50 mm

49 mm / 56.5 mm

IEC	UL - CSA
0.2 - 4.0 mm ²	24 - 10 AWG
0.2 - 6.0 mm ²	
0.2 - 4.0 mm ²	24 - 12 AWG
0.5 - 2.5 mm ²	20 - 14 AWG

9 mm

IEC60947-7-1	UL-1059	CSA22.2-158	IEC60079-7
1000 V	600 V	600 V	630 V
32 A	30 A	30 A	28 A
0.5 Nm	4.5 lb.in	4.5 lb.in	0.5 Nm



Polyamide 6,6 / 1

8 KV / 3

Type / Cat. No.	Standard Pack
CY4	100
CY4BU	100
CY4G (Refer Pg. 80 for details)	100
EPCY2.5/10	50
PPCY2.5/10	20
CA701-1M / CA701-1M-S	50 m
CA701-15-1M / CA701-15-1M-S	25 m
CA702 / CA802 / CA103	50
CA509/K6WHT	100
SCS0.6/3.5 Blade size: 0.6 x 3.0 mm	10

Type / Cat. No.	I _{max}	Standard Pack
JX4/2	32 A	100
JX4/3	32 A	50
JX4/4	32 A	50
JX4/8	32 A	10
JX4/10	32 A	10

CY6



8 x 50 mm

49 mm / 56.5 mm

IEC	UL - CSA
0.2 - 6.0 mm ²	24 - 8 AWG
0.2 - 10.0 mm ²	
0.2 - 6.0 mm ²	24 - 8 AWG
0.5 - 4.0 mm ²	20 - 12 AWG

10 mm

IEC60947-7-1	UL-1059	CSA22.2-158	IEC60079-7
1000 V	600 V	600 V	630 V
41 A	50 A	50 A	36 A
0.8 Nm	11 lb.in	11 lb.in	0.8 Nm



Polyamide 6,6 / 1

8 KV / 3

Type / Cat. No.	Standard Pack
CY6	100
CY6BU	100
CY6G (Refer Pg. 80 for details)	100
EPCY2.5/10	50
PPCY2.5/10	20
CA701-1M / CA701-1M-S	50 m
CA701-15-1M / CA701-15-1M-S	25 m
CA702 / CA802 / CA103	50
CA509/K8WHT	100
SCS0.8/4 Blade size: 0.8 x 4 mm	10

Type / Cat. No.	I _{max}	Standard Pack
JY6/2	35 A	100
JY6/2.5	24 A	20

CY10



10 x 50 mm

49 mm / 56.5 mm

IEC	UL - CSA
0.2 - 10.0 mm ²	24 - 6 AWG
0.2 - 10.0 mm ²	
0.2 - 10.0 mm ²	24 - 6 AWG
0.5 - 6.0 mm ²	

11 mm

IEC60947-7-1	UL-1059	CSA22.2-158	IEC60079-7
1000 V	600 V	600 V	630 V
57 A	65 A	65 A	51 A
1.2 Nm	14 lb.in	14 lb.in	1.2 Nm



Polyamide 6,6 / 1

8 KV / 3

Type / Cat. No.	Standard Pack
CY10	50
CY10BU	50
CY10G (Refer Pg. 80 for details)	50
EPCY2.5/10	50
PPCY2.5/10	20
CA701-1M / CA701-1M-S	50 m
CA701-15-1M / CA701-15-1M-S	25 m
CA702 / CA802 / CA103	50
CA509/K10WHT	100
SCS0.8/4 Blade size: 0.8 x 4 mm	10

Type / Cat. No.	I _{max}	Standard Pack
JY10/2	45 A	20
JY10/2.5	24 A	20

GROUND / EARTH TERMINAL BLOCKS

CYG series are earthing Terminal Blocks with specially designed alloy feet which help in achieving very low contact resistance and vibration proof grounding with the DIN rails. They are green / yellow colour coded as per industry standards.

Cross connection of these Terminal Blocks can be done using standard pluggable jumpers.

Width (Thickness) x Length		5 x 50 mm				
Height with DIN 35 x 7.5 / 35 x 15 mm Rail		49 mm / 56.5 mm				
Connection Possibility as per		IEC	UL - CSA			
With 1 Conductor per clamp	Stranded / Flexible	0.2 - 2.5 mm ²	24 - 14 AWG			
	Solid	0.2 - 4.0 mm ²	24 - 12 AWG			
	with Ferrule / Lug	0.2 - 2.5 mm ²	24 - 14 AWG			
With 2 same size Conductors per clamp	with TWIN Ferrule / Lug	0.5 - 1.5 mm ²	20 - 16 AWG			
Wire Stripping Length		8 mm				
Ratings As Per		IEC60947-2	UL-1059	CSA22.2-158	IEC60079-7	
Torque		0.4 Nm	4.5 lb.in	4.5 lb.in	0.4 Nm	
Approval						
Insulation Material / Material Group		Polyamide 6,6 / 1				
Rated Impulse Voltage / Pollution Degree		8 KV / 3				
		Type / Cat. No.	Standard Pack			
Terminal Block		CYG2.5	100			
End Plate		EPCY2.5/10	50			
Partition Plate		PPCY2.5/10	20			
Mounting Rail (Refer Pg. 217 for details)		CA701-1M / CA701-1M-S	50 m			
		CA701-15-1M / CA701-15-1M-S	25 m			
End Clamp (Refer Pg. 218 for details)		CA702 / CA802 / CA103	50			
Test Plug		TX2.5	20			
Marking Tags (Refer Pg. 222 for details)		CA509/K5WHT	100			
Screw Driver		SCS0.5/3	Blade size: 0.5 x 3.0 mm		10	
Jumpers		Type / Cat. No.	Imax	Standard Pack		
Pluggable Jumpers	2 pole	JX2.5/2	24 A	100		
	3 pole	JX2.5/3	24 A	50		
	4 pole	JX2.5/4	24 A	50		
	5 pole	JX2.5/5	24 A	50		
	6 pole	JX2.5/6	24 A	10		
	7 pole	JX2.5/7	24 A	10		
	8 pole	JX2.5/8	24 A	10		
	10 pole	JX2.5/10	24 A	10		
	Step Down Jumpers					

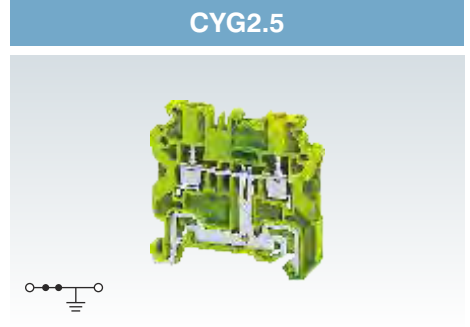

CYG4



6 x 50 mm

49 mm / 56.5 mm

IEC	UL - CSA
0.2 - 4.0 mm ²	24 - 10 AWG
0.2 - 6.0 mm ²	
0.2 - 4.0 mm ²	24 - 12 AWG
0.5 - 2.5 mm ²	20 - 14 AWG

9 mm

IEC60947-7-2 UL-1059 CSA22.2-158 IEC60079-7

0.5 Nm	4.5 lb.in	4.5 lb.in	0.5 Nm
--------	-----------	-----------	--------



Polyamide 6,6 / 1

8 KV / 3

Type / Cat. No.	Standard Pack
CYG4	100
EPCY2.5/10	50
PPCY2.5/10	20
CA701-1M / CA701-1M-S	50 m
CA701-15-1M / CA701-15-1M-S	25 m
CA702 / CA802 / CA103	50
CA509/K6WHT	100
SCS0.6/3.5 Blade size: 0.6 x 3.5 mm	10

Type / Cat. No.	I _{max}	Standard Pack
JX4/2	32 A	100
JX4/3	32 A	50
JX4/4	32 A	50
JX4/8	32 A	10
JX4/10	32 A	10

CYG6

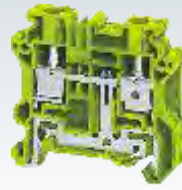

8 x 50 mm

49 mm / 56.5 mm

IEC	UL - CSA
0.2 - 6.0 mm ²	24 - 8 AWG
0.2 - 10.0 mm ²	
0.2 - 6.0 mm ²	24 - 8 AWG
0.5 - 4.0 mm ²	20 - 12 AWG

10 mm

IEC60947-7-2 UL-1059 CSA22.2-158 IEC60079-7

0.8 Nm	11 lb.in	11 lb.in	0.8 Nm
--------	----------	----------	--------



Polyamide 6,6 / 1

8 KV / 3

Type / Cat. No.	Standard Pack
CYG6	100
EPCY2.5/10	50
PPCY2.5/10	20
CA701-1M / CA701-1M-S	50 m
CA701-15-1M / CA701-15-1M-S	25 m
CA702 / CA802 / CA103	50
CA509/K8WHT	100
SCS0.8/4 Blade size: 0.8 x 4 mm	10

Type / Cat. No.	I _{max}	Standard Pack
JY6/2	35 A	100
JYS6/2.5	24 A	20

CYG10

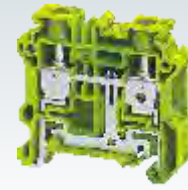

10 x 50 mm

49 mm / 56.5 mm

IEC	UL - CSA
0.2 - 10.0 mm ²	24 - 6 AWG
0.2 - 10.0 mm ²	
0.2 - 10.0 mm ²	24 - 6 AWG
0.5 - 6.0 mm ²	

11 mm

IEC60947-7-2 UL-1059 CSA22.2-158 IEC60079-7

1.2 Nm	14 lb.in	14 lb.in	1.2 Nm
--------	----------	----------	--------



Polyamide 6,6 / 1

8 KV / 3

Type / Cat. No.	Standard Pack
CYG10	50
EPCY2.5/10	20
PPCY2.5/10	20
CA701-1M / CA701-1M-S	50 m
CA701-15-1M / CA701-15-1M-S	25 m
CA702 / CA802 / CA103	50
CA509/K10WHT	100
SCS0.8/4 Blade size: 0.8 x 4 mm	10

Type / Cat. No.	I _{max}	Standard Pack
JY10/2	45 A	20
JYS10/2.5	24 A	20

MULTIPLE CONNECTION TERMINAL BLOCKS

CY series multi connect 3 wire & 4 wire screw clamp Terminal Blocks are used to eliminate reliability problems encountered when there is a need to connect multiple wires in a single Terminal Block.

CY4/3



Width (Thickness) x Length	6 x 58.8 mm		
Height with DIN 35 x 7.5 / 35 x 15 mm Rail	50.7 mm / 58.2 mm		
Connection Possibility as per	IEC	UL - CSA	
With 1 Conductor per clamp	Stranded / Flexible	0.2 - 4.0 mm ²	24 - 10 AWG
	Solid with Ferrule / Lug	0.2 - 6.0 mm ²	24 - 12 AWG
With 2 same size Conductors per clamp	with TWIN Ferrule / Lug	0.5 - 2.5 mm ²	20 - 14 AWG
Wire Stripping Length	9 mm		
Ratings As Per	IEC60947-7-1	UL-1059	CSA22.2-158
Voltage	500 V	150 V	600 V
Current	32 A	30 A	30 A
Torque	0.5 Nm	4.5 lb.in	4.5 lb.in
Approval	CE		
Insulation Material / Material Group	Polyamide 6,6 / 1		
Rated Impulse Voltage / Pollution Degree	8 KV / 3		

	Type / Cat. No.	Standard Pack	
Terminal Block	Grey	CY4/3	50
	Blue	CY4/3BU	50
	Ground / Earth	CYG4/3	50
End Plate	EPCY4/3	50	
Mounting Rail (Refer Pg. 217 for details)	CA701-1M / CA701-1M-S	50 m	
	CA701-15-1M / CA701-15-1M-S	25 m	
End Clamp (Refer Pg. 218 for details)	CA702 / CA802 / CA103	50	
Marking Tags (Refer Pg. 222 for details)	CA509/K6WHT	100	
Screw Driver	SCS0.6/3.5 Blade size: 0.6 x 3.5 mm	10	

Jumpers	Type / Cat. No.	I _{max}	Standard Pack	
Pluggable Jumpers	2 pole	JX4/2	32 A	100
	3 pole	JX4/3	32 A	50
	4 pole	JX4/4	32 A	50
	5 pole			
	6 pole			
	7 pole			
	8 pole	JX4/8	32 A	10
	10 pole	JX4/10	32 A	10

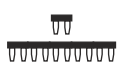

CY4/4



6 x 69.7 mm

50.7 mm / 58.2 mm

IEC	UL - CSA
0.2 - 4.0 mm ²	24 - 10 AWG
0.2 - 6.0 mm ²	
0.2 - 4.0 mm ²	24 - 12 AWG
0.5 - 2.5 mm ²	20 - 14 AWG

9 mm

IEC60947-7-1 UL-1059 CSA22.2-158

500 V	150 V	600 V
32 A	30 A	30 A
0.5 Nm	4.5 lb.in	4.5 lb.in



Polyamide 6,6 / 1

8 KV / 3

Type / Cat. No.	Standard Pack
CY4/4	50
CY4/4BU	50
CYG4/4	50
EPCY4/4	50
CA701-1M / CA701-1M-S	50 m
CA701-15-1M / CA701-15-1M-S	25 m
CA702 / CA802 / CA103	50
CA509/K6WHT	100
SCS0.6/3.5 Blade size: 0.6 x 3.5 mm	10

Type / Cat. No.	I _{max}	Standard Pack
JX4/2	32 A	100
JX4/3	32 A	50
JX4/4	32 A	50
JX4/8	32 A	10
JX4/10	32 A	10

CYG4/3

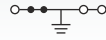

6 x 58.8 mm

50.7 mm / 58.2 mm

IEC	UL - CSA
0.2 - 4.0 mm ²	24 - 10 AWG
0.2 - 6.0 mm ²	
0.2 - 4.0 mm ²	24 - 12 AWG
0.5 - 2.5 mm ²	20 - 14 AWG

9 mm

IEC60947-7-2 UL-1059 CSA22.2-158

500 V	150 V	600 V
32 A	30 A	30 A
0.5 Nm	4.5 lb.in	4.5 lb.in



Polyamide 6,6 / 1

8 KV / 3

Type / Cat. No.	Standard Pack
CYG4/3	50
EPCY4/3	50
CA701-1M / CA701-1M-S	50 m
CA701-15-1M / CA701-15-1M-S	25 m
CA702 / CA802 / CA103	50
CA509/K6WHT	100
SCS0.6/3.5 Blade size: 0.6 x 3.5 mm	10

Type / Cat. No.	I _{max}	Standard Pack
JX4/2	32 A	100
JX4/3	32 A	50
JX4/4	32 A	50
JX4/8	32 A	10
JX4/10	32 A	10

CYG4/4

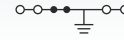
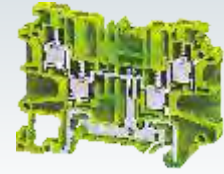

6 x 69.7 mm

50.7 mm / 58.2 mm

IEC	UL - CSA
0.2 - 4.0 mm ²	24 - 10 AWG
0.2 - 6.0 mm ²	
0.2 - 4.0 mm ²	24 - 12 AWG
0.5 - 2.5 mm ²	20 - 14 AWG

9 mm

IEC60947-7-2 UL-1059 CSA22.2-158

500 V	150 V	600 V
32 A	30 A	30 A
0.5 Nm	4.5 lb.in	4.5 lb.in



Polyamide 6,6 / 1

8 KV / 3

Type / Cat. No.	Standard Pack
CYG4/4	50
EPCY4/4	50
CA701-1M / CA701-1M-S	50 m
CA701-15-1M / CA701-15-1M-S	25 m
CA702 / CA802 / CA103	50
CA509/K6WHT	100
SCS0.6/3.5 Blade size: 0.6 x 3.5 mm	10

Type / Cat. No.	I _{max}	Standard Pack
JX4/2	32 A	100
JX4/3	32 A	50
JX4/4	32 A	50
JX4/8	32 A	10
JX4/10	32 A	10

MULTIPLE LEVEL TERMINAL BLOCKS

CYDL2.5 is the next generation compact double level Screw Clamp Terminal Block. This Terminal Block is used in high density wiring applications.

Jumpering is possible at both levels. This Terminal Block is suitable for 1000 V rating.







CYDL2.5(I.S) is double level internally shorted screw clamp Terminal Block. This is an ideal choice for distribution application.

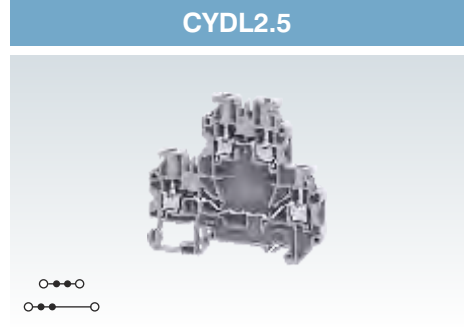







CYDLG2.5 is double level Terminal Block with a grounding point for terminating grounding cables on the lower level of the terminal block while the top level is a standard feed through terminal. The earth connection is made by snapping the terminal on the Din rail. This separate connection point is appropriately identified by the green-yellow imprint on its top.

CYDLG2.5(I.S) is double level ground Terminal Block with 4 connection points for grounding wires. It is available in a standard green yellow colour to indicate the grounding connection.

Width (Thickness) x Length		5 x 70.5 mm			
Height with DIN 35 x 7.5 / 35 x 15 mm Rail		65.9 mm / 73.4 mm			
Connection Possibility as per		IEC		UL - CSA	
With 1 Conductor per clamp	Stranded / Flexible	0.2 - 2.5 mm ²		24 - 12 AWG	
	Solid	0.2 - 4.0 mm ²		24 - 10 AWG	
	with Ferrule / Lug	0.2 - 2.5 mm ²		24 - 12 AWG	
With 2 same size Conductors per clamp	with TWIN Ferrule / Lug	0.2 - 1.0 mm ²		24 - 20 AWG	
Wire Stripping Length		8 mm			
Ratings As Per		IEC60947-7-1 UL-1059 CSA22.2-158			
Voltage		500 V	300 V	300 V	
Current		24 A	20 A	20 A	
Torque		0.4 Nm	3.6 lb.in	3.6 lb.in	
Approval					
Insulation Material / Material Group		Polyamide 6,6 / 1			
Rated Impulse Voltage / Pollution Degree		8 KV / 3			



		Type / Cat. No.	Standard Pack
Terminal Block	Grey	CYDL2.5	50
	Blue	CYDL2.5BU	50
	Ground / Earth	CYDLG2.5(I.S)	50
End Plate		EPCYDL2.5/4	50
Mounting Rail (Refer Pg. 217 for details)		CA701-1M / CA701-1M-S	50 m
		CA701-15-1M / CA701-15-1M-S	25 m
End Clamp (Refer Pg. 218 for details)		CA702 / CA802 / CA103	50
Test Plug		TX2.5	20
Marking Tags (Refer Pg. 222 for details)		CA509/K5WHT	100
Screw Driver		SCS0.5/3 Blade size: 0.5 x 3.0 mm	10

Jumpers		Type / Cat. No.	I _{max}	Standard Pack
Pluggable Jumpers		JX2.5/2	24 A	100
		JX2.5/3	24 A	50
		JX2.5/4	24 A	50
		JX2.5/5	24 A	50
		JX2.5/6	24 A	10
		JX2.5/7	24 A	10
		JX2.5/8	24 A	10
		JX2.5/10	24 A	10

CYDL2.5(I.S)



5 x 70.5 mm

65.9 mm / 73.4 mm

IEC	UL - CSA
0.2 - 2.5 mm ²	24 - 12 AWG
0.2 - 4.0 mm ²	24 - 10 AWG
0.2 - 2.5 mm ²	24 - 12 AWG
0.2 - 1.0 mm ²	24 - 20 AWG

8 mm

IEC60947-7-1 UL-1059 CSA22.2-158

500 V	300 V	300 V
24 A	20 A	20 A
0.4 Nm	3.6 lb.in	3.6 lb.in



Polyamide 6,6 / 1

8 KV / 3

Type / Cat. No.	Standard Pack
CYDL2.5(I.S)	50

EPCYDL2.5/4	50
CA701-1M / CA701-1M-S	50 m
CA701-15-1M / CA701-15-1M-S	25 m
CA702 / CA802 / CA103	50
TX2.5	20
CA509/K5WHT	100
SCS0.5/3 Blade size: 0.5 x 3.0 mm	10

Type / Cat. No.	Imax	Standard Pack
JX2.5/2	24 A	100
JX2.5/3	24 A	50
JX2.5/4	24 A	50
JX2.5/5	24 A	50
JX2.5/6	24 A	10
JX2.5/7	24 A	10
JX2.5/8	24 A	10
JX2.5/10	24 A	10

CYDLG2.5



5 x 70.5 mm

65.9 mm / 73.4 mm

IEC	UL - CSA
0.2 - 2.5 mm ²	24 - 12 AWG
0.2 - 4.0 mm ²	24 - 10 AWG
0.2 - 2.5 mm ²	24 - 12 AWG
0.2 - 1.0 mm ²	24 - 20 AWG

8 mm

IEC60947-7-1 UL-1059 CSA22.2-158

500 V	300 V	300 V
24 A	20 A	20 A
0.4 Nm	3.6 lb.in	3.6 lb.in



Polyamide 6,6 / 1

8 KV / 3

Type / Cat. No.	Standard Pack
CYDLG2.5	50

EPCYDL2.5/4	50
CA701-1M / CA701-1M-S	50 m
CA701-15-1M / CA701-15-1M-S	25 m
CA702 / CA802 / CA103	50
TX2.5	20
CA509/K5WHT	100
SCS0.5/3 Blade size: 0.5 x 3.0 mm	10

Type / Cat. No.	Imax	Standard Pack
JX2.5/2	24 A	100
JX2.5/3	24 A	50
JX2.5/4	24 A	50
JX2.5/5	24 A	50
JX2.5/6	24 A	10
JX2.5/7	24 A	10
JX2.5/8	24 A	10
JX2.5/10	24 A	10

CYDLG2.5(I.S)

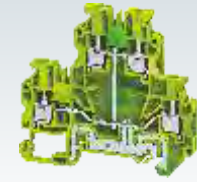

5 x 70.5 mm

65.9 mm / 73.4 mm

IEC	UL - CSA
0.2 - 2.5 mm ²	24 - 12 AWG
0.2 - 4.0 mm ²	24 - 10 AWG
0.2 - 2.5 mm ²	24 - 12 AWG
0.2 - 1.0 mm ²	24 - 20 AWG

8 mm

IEC60947-7-1 UL-1059 CSA22.2-158

500 V	300 V	300 V
24 A	20 A	20 A
0.4 Nm	3.6 lb.in	3.6 lb.in



Polyamide 6,6 / 1

8 KV / 3

Type / Cat. No.	Standard Pack
CYDLG2.5(I.S)	50

EPCYDL2.5/4	50
CA701-1M / CA701-1M-S	50 m
CA701-15-1M / CA701-15-1M-S	25 m
CA702 / CA802 / CA103	50
TX2.5	20
CA509/K5WHT	100
SCS0.5/3 Blade size: 0.5 x 3.0 mm	10

Type / Cat. No.	Imax	Standard Pack
JX2.5/2	24 A	100
JX2.5/3	24 A	50
JX2.5/4	24 A	50
JX2.5/5	24 A	50
JX2.5/6	24 A	10
JX2.5/7	24 A	10
JX2.5/8	24 A	10
JX2.5/10	24 A	10

MULTIPLE LEVEL TERMINAL BLOCKS

CYDL4 is the next generation compact double level Screw Clamp Terminal Block. This Terminal Block is used in high density wiring applications.

Interconnections / shorting is possible at both levels. This Terminal Block is suitable for 1000 V rating.

CYDL4(I.S) is double level internally shorted screw clamp Terminal Block. This is an ideal choice for distribution application.

CYDLG4 is double level Terminal Block with a grounding point for terminating grounding cables on the lower level of the terminal block while the top level is a standard feed through terminal. The earth connection is made by snapping the terminal on the Din rail. This separate connection point is appropriately identified by the green-yellow imprint on its top.

CYDLG4(I.S) is double level ground Terminal Block with 4 connection points for grounding wires. It is available in a standard green yellow colour to indicate the grounding connection.

Width (Thickness) x Length	6 x 70.5 mm
----------------------------	-------------

Height with DIN 35 x 7.5 / 35 x 15 mm Rail	65.9 mm / 73.4 mm
--	-------------------

Connection Possibility as per	
-------------------------------	--

With 1 Conductor per clamp	Stranded / Flexible	0.2 - 4.0 mm ²
	Solid with Ferrule / Lug	0.2 - 6.0 mm ²

With 2 same size Conductors per clamp	with TWIN Ferrule / Lug	0.5 - 2.5 mm ²
---------------------------------------	-------------------------	---------------------------

Wire Stripping Length	9 mm
-----------------------	------

Ratings As Per	IEC60947-7-1	UL-1059	CSA22.2-158
----------------	--------------	---------	-------------

Voltage	800 V	300 V	300 V
---------	-------	-------	-------







Current	32 A	30 A	30 A
---------	------	------	------

Torque	0.5 Nm	4.5 lb.in	4.5 lb.in
--------	--------	-----------	-----------

Approval	CE
----------	----

Insulation Material / Material Group	Polyamide 6,6 / 1
--------------------------------------	-------------------

Rated Impulse Voltage / Pollution Degree	8 KV / 3
--	----------

Terminal Block	Grey Blue Ground / Earth
End Plate	
Partition Plate	
Mounting Rail (Refer Pg. 217 for details)	
End Clamp (Refer Pg. 218 for details)	
Marking Tags (Refer Pg. 222 for details)	
Screw Driver	

CYDL4



Width (Thickness) x Length	6 x 70.5 mm
----------------------------	-------------

Height with DIN 35 x 7.5 / 35 x 15 mm Rail	65.9 mm / 73.4 mm
--	-------------------

Connection Possibility as per	
-------------------------------	--

With 1 Conductor per clamp	Stranded / Flexible	0.2 - 4.0 mm ²
	Solid with Ferrule / Lug	0.2 - 6.0 mm ²

With 2 same size Conductors per clamp	with TWIN Ferrule / Lug	0.5 - 2.5 mm ²
---------------------------------------	-------------------------	---------------------------

Wire Stripping Length	9 mm
-----------------------	------

Ratings As Per	IEC60947-7-1	UL-1059	CSA22.2-158
----------------	--------------	---------	-------------

Voltage	800 V	300 V	300 V
---------	-------	-------	-------

Current	32 A	30 A	30 A
---------	------	------	------

Torque	0.5 Nm	4.5 lb.in	4.5 lb.in
--------	--------	-----------	-----------

Approval	CE
----------	----

Insulation Material / Material Group	Polyamide 6,6 / 1
--------------------------------------	-------------------

Rated Impulse Voltage / Pollution Degree	8 KV / 3
--	----------

Type / Cat. No.	Standard Pack
CYDL4	50
CYDL4BU	50
CYDLG4(I.S.)	50
EPCYDL2.5/4	50
PPCYDL2.5/4	20
CA701-1M / CA701-1M-S	50 m
CA701-15-1M / CA701-15-1M-S	25 m
CA702 / CA802 / CA103	50
CA509/K6WHT	100
SCS0.6/3.5 Blade size: 0.6 x 3.5 mm	10

Jumpers	
---------	--

Pluggable Jumpers		2 pole
		3 pole
		4 pole
		8 pole
		10 pole

Type / Cat. No.	Imax	Standard Pack
-----------------	------	---------------

JX4/2	32 A	100
JX4/3	32 A	50
JX4/4	32 A	50
JX4/8	32 A	10
JX4/10	32 A	10

CYDL4(I.S)



6 x 70.5 mm

65.9 mm / 73.4 mm

IEC	UL - CSA
0.2 - 4.0 mm ²	24 - 10 AWG
0.2 - 6.0 mm ²	
0.2 - 4.0 mm ²	24 - 12 AWG
0.5 - 2.5 mm ²	20 - 14 AWG

9 mm

IEC60947-7-1 UL-1059 CSA22.2-158

800 V	300 V	300 V
32 A	30 A	30 A
0.5 Nm	4.5 lb.in	4.5 lb.in



Polyamide 6,6 / 1

8 KV / 3

Type / Cat. No.	Standard Pack
CYDL4(I.S)	50

EPCYDL2.5/4	50
PPCYDL2.5/4	20
CA701-1M / CA701-1M-S	50 m
CA701-15-1M / CA701-15-1M-S	25 m
CA702 / CA802 / CA103	50
CA509/K6WHT	100
SCS0.6/3.5 Blade size: 0.6 x 3.5 mm	10

Type / Cat. No.	I _{max}	Standard Pack
JX4/2	32 A	100
JX4/3	32 A	50
JX4/4	32 A	50
JX4/8	32 A	10
JX4/10	32 A	10

CYDLG4



6 x 70.5 mm

65.9 mm / 73.4 mm

IEC	UL - CSA
0.2 - 4.0 mm ²	24 - 10 AWG
0.2 - 6.0 mm ²	
0.2 - 4.0 mm ²	24 - 12 AWG
0.5 - 2.5 mm ²	20 - 14 AWG

9 mm

IEC60947-7-1 UL-1059 CSA22.2-158

800 V	300 V	300 V
32 A	30 A	30 A
0.5 Nm	4.5 lb.in	4.5 lb.in



Polyamide 6,6 / 1

8 KV / 3

Type / Cat. No.	Standard Pack
CYDLG4	50

EPCYDL2.5/4	50
PPCYDL2.5/4	20
CA701-1M / CA701-1M-S	50 m
CA701-15-1M / CA701-15-1M-S	25 m
CA702 / CA802 / CA103	50
CA509/K6WHT	100
SCS0.6/3.5 Blade size: 0.6 x 3.5 mm	10

Type / Cat. No.	I _{max}	Standard Pack
JX4/2	32 A	100
JX4/3	32 A	50
JX4/4	32 A	50
JX4/8	32 A	10
JX4/10	32 A	10

CYDLG4(I.S)



6 x 70.5 mm

65.9 mm / 73.4 mm

IEC	UL - CSA
0.2 - 4.0 mm ²	24 - 10 AWG
0.2 - 6.0 mm ²	
0.2 - 4.0 mm ²	24 - 12 AWG
0.5 - 2.5 mm ²	20 - 14 AWG

9 mm

IEC60947-7-2 UL-1059 CSA22.2-158

800 V	300 V	300 V
32 A	30 A	30 A
0.5 Nm	4.5 lb.in	4.5 lb.in



Polyamide 6,6 / 1

8 KV / 3

Type / Cat. No.	Standard Pack
CYDLG4(I.S)	50

EPCYDL2.5/4	50
PPCYDL2.5/4	20
CA701-1M / CA701-1M-S	50 m
CA701-15-1M / CA701-15-1M-S	25 m
CA702 / CA802 / CA103	50
CA509/K6WHT	100
SCS0.6/3.5 Blade size: 0.6 x 3.5 mm	10

Type / Cat. No.	I _{max}	Standard Pack
JX4/2	32 A	100
JX4/3	32 A	50
JX4/4	32 A	50
JX4/8	32 A	10
JX4/10	32 A	10

FUSE TERMINAL BLOCKS

These Terminal Blocks are used in electrical and control systems which require fuse protection.

CYF4 series fuse terminals have a thickness of 6 mm with a provision for using pluggable Jumpers. These Terminal Blocks are completely closed type and do not need separate end plate.

CYDLF4 terminal has an additional feed through connection level.

CYDLGF4 terminal has a feed through connection level along with ground connection point in addition to a standard hinged fuse carrier.

CYDL4FT terminal has a feed through system on both levels.

CYDLGF4FT has two feed through levels and an additional ground connection point.

CYDLF4LR is modified version of CYDLF4 where two equi-potential connection joints are available on both side of the Terminal Block.

CYF4



Width (Thickness) x Length	6 x 58.8 mm		
Height with DIN 35 x 7.5 / 35 x 15 / 32 mm Rail	72.4 mm / 79.9 mm		
Connection Possibility as per	IEC	UL - CSA	
With 1 Conductor per clamp	Stranded / Flexible	0.2 - 4.0 mm ²	24 - 10 AWG
	Solid with Ferrule / Lug	0.2 - 6.0 mm ²	24 - 12 AWG
With 2 same size Conductors per clamp	Stranded / Flexible	0.2 - 4.0 mm ²	24 - 16 AWG
	with TWIN Ferrule / Lug	0.5 - 2.5 mm ²	20 - 14 AWG
Wire Stripping Length	9 mm		
Ratings As Per	IEC60947-7-3	UL-1059	CSA22.2-158
Voltage	1000 V	600 V	600 V
	Current	10 A	10 A
Torque	Fuse Level		
	Feed Through Level		
Approvals	0.5 Nm	4.5 lb-in	4.5 lb-in
Insulation Material / Material Group	Polyamide 6,6 / 1		
Rated Impulse Voltage / Pollution Degree	6 kV / 3		
Fuse Size	Ø5 x 20 mm		

Type / Cat. No.	Standard Pack
CYF4	50
CYF4BU	50
CYF4BK	50
CYF4L6-60V	50
CYF4L110-240V	50
CA701-1M / CA701-1M-S	50 m
CA701-15-1M / CA701-15-1M-S	25 m
CA702 / CA802	50
CA509/K6WHT	100
SCS0.6/3.5 Blade size: 0.6 x 3.5 mm	10

Jumpers	Type / Cat. No.	I _{max}	Standard Pack
Pluggable Jumpers	JX4/2	32 A	100
	JX4/3	32 A	50
	JX4/4	32 A	50
	JX4/8	32 A	10
	JX4/10	32 A	10

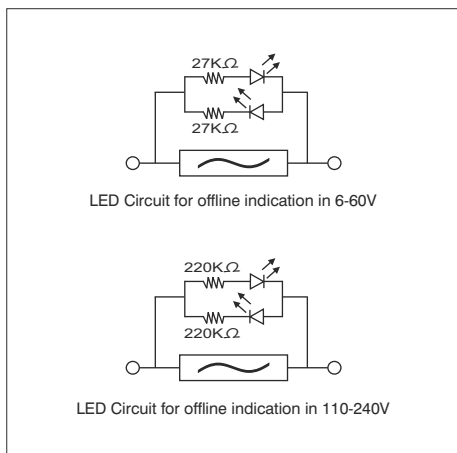

CYDLF4

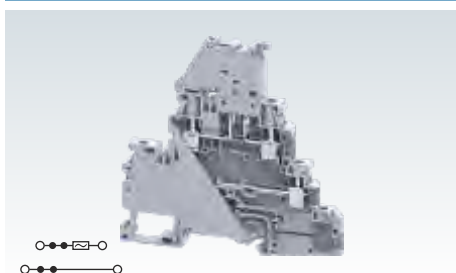

6 x 94.5 mm

90.9 mm / 98.4 mm

IEC	UL - CSA
0.2 - 4.0 mm ²	24 - 10 AWG
0.2 - 6.0 mm ²	
0.2 - 4.0 mm ²	24 - 12 AWG
0.2 - 1.5 mm ²	24 - 16 AWG
0.5 - 2.5 mm ²	20 - 14 AWG

9 mm

IEC60947-7-3 UL-1059

500 V	300 V		
10 A	10 A		
32 A	30 A		

0.5 Nm	4.5 lb-in		



Polyamide 6,6 / 1

6 KV / 3

Ø5 x 20 mm

Type / Cat. No.	Standard Pack
CYDLF4	50
CYDLF4L6-60V	50
CYDLF4L110-240V	50
CYDLF4FT	50
CYDLFG4FT	50
CA701-1M / CA701-1M-S	50 m
CA701-15-1M / CA701-15-1M-S	25 m
CA702 / CA802 / CA202	50
CA509/K6WHT	100
SCS0.6/3.5 Blade size: 0.6 x 3.5 mm	10

Type / Cat. No.	I _{max}	Standard Pack
JX4/2	32 A	100
JX4/3	32 A	50
JX4/4	32 A	50
JX4/8	32 A	10
JX4/10	32 A	10

CYDLGF4

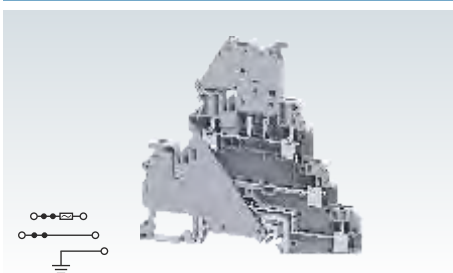

6 x 94.5 mm

90.9 mm / 98.4 mm

IEC	UL - CSA
0.2 - 4.0 mm ²	24 - 10 AWG
0.2 - 6.0 mm ²	
0.2 - 4.0 mm ²	24 - 12 AWG
0.2 - 1.5 mm ²	24 - 16 AWG
0.5 - 2.5 mm ²	20 - 14 AWG

9 mm

IEC60947-7-3 UL-1059

500 V	300 V		
10 A	10 A		
32 A	30 A		

0.5 Nm	4.5 lb-in		



Polyamide 6,6 / 1

6 KV / 3

Ø5 x 20 mm

Type / Cat. No.	Standard Pack
CYDLGF4	50
CYDLGF4L6-60V	50
CYDLGF4L110-240V	50
CYDLGF4FT	50
CYDLFG4FT	50
CA701-1M / CA701-1M-S	50 m
CA701-15-1M / CA701-15-1M-S	25 m
CA702 / CA802 / CA202	50
CA509/K6WHT	100
SCS0.6/3.5 Blade size: 0.6 x 3.5 mm	10

Type / Cat. No.	I _{max}	Standard Pack
JX4/2	32 A	100
JX4/3	32 A	50
JX4/4	32 A	50
JX4/8	32 A	10
JX4/10	32 A	10

CYDLF4LR



6 x 94.5 mm

67.6 mm / 75.1 mm

IEC	UL - CSA
0.2 - 4.0 mm ²	24 - 10 AWG
0.2 - 6.0 mm ²	
0.2 - 4.0 mm ²	24 - 12 AWG
0.2 - 1.5 mm ²	24 - 16 AWG
0.5 - 2.5 mm ²	24 - 14 AWG

9 mm

IEC60947-7-1 UL-1059

630 V	300 V		
10 A	10 A		

0.5 Nm	4.5 lb-in		



Polyamide 6,6 / 1

6 KV / 3

Ø5 x 20 mm

Type / Cat. No.	Standard Pack
CYDLF4LR	50
CYDLGF4LR	50
CYDLF4LRL6-60V	50
CYDLF4LRL110-240V	50
CYDLF4FT	50
CYDLFG4FT	50
CA701-1M / CA701-1M-S	50 m
CA701-15-1M / CA701-15-1M-S	25 m
CA702 / CA802 / CA202	50
CA509/K6WHT	100
SCS0.6/3.5 Blade size: 0.6 x 3.5 mm	10

Type / Cat. No.	I _{max}	Standard Pack
JX4/2	32 A	100
JX4/3	32 A	50
JX4/4	32 A	50
JX4/8	32 A	50
JX4/10	32 A	10

DISCONNECT & TEST TERMINAL BLOCKS

These blocks are used for measuring, control and regulatory circuits.

In CYK4 terminals, disconnection is achieved by lifting a lever which operates the knife contact.

Specially designed socket headed screws act as test monitoring points in these Terminal Blocks.

Standard JX series push in jumpers can be used for interconnection.

CYDLK4 terminal is a double level disconnect Terminal Block with knife contact disconnect function at the top level and a feed through at the bottom level.

In the CYDLGK4 terminal, a grounding wire connection point is available in addition to the feed through and disconnect functionality.

CYK4

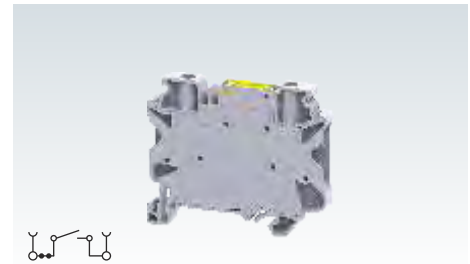

Width (Thickness) x Length		6 x 58.8 mm	
Height with DIN 35 x 7.5 / 35 x 15		51.5 mm / 56.6 mm	
Connection Possibility as per		IEC	UL - CSA
With 1 Conductor per clamp	Stranded / Flexible	0.2 - 4.0 mm ²	24 - 10 AWG
	Solid	0.2 - 6.0 mm ²	
With 2 same size Conductors per clamp	with Ferrule / Lug	0.2 - 4.0 mm ²	24 - 12 AWG
	Stranded / Flexible with TWIN Ferrule / Lug	0.2 - 1.5 mm ²	24 - 16 AWG
Wire Stripping Length		10 mm	
Ratings As Per		IEC60947-7-1 UL-1059	
Voltage		1000 V	600 V
Current	Disconnecting Level	28 A	26 A
	Feed Through Level		
Torque		0.5 Nm	4.5 lb-in
Approvals			
Insulation Material / Material Group		Polyamide 6,6 / 1	
Rated Impulse Voltage / Pollution Degree		6 KV / 3	
		Type / Cat. No.	Standard Pack
Terminal Block	Grey	CYK4	50
	Blue	CYK4BU	50
	Feed Through Version	CY4	100
Mounting Rail (Refer Pg. 217 for details)		CA701-1M / CA701-1M-S	50 m
		CA701-15-1M / CA701-15-1M-S	25 m
End Clamp (Refer Pg. 218 for details)		CA702 / CA802	50
Marking Tags (Refer Pg. 222 for details)		CA509/K6WHT	100
Screw Driver		SCS0.6/3.5 Blade size: 0.6 x 3.5 mm	10

Jumpers		Type / Cat. No.	I _{max}	Standard Pack
Pluggable Jumpers		JX4/2	32 A	100
		JX4/3	32 A	50
		JX4/4	32 A	50
		JX4/8	32 A	50
		JX4/10	32 A	10

* Shorting link current should not exceed more than Terminal Block current rating

CYDLK4

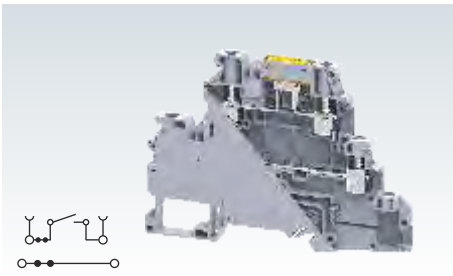

6 x 94.5 mm

67.6 mm / 75.1 mm

IEC	UL - CSA
0.2 - 4.0 mm ²	24 - 10 AWG
0.2 - 6.0 mm ²	
0.2 - 4.0 mm ²	24 - 12 AWG
0.2 - 1.5 mm ²	24 - 16 AWG
0.5 - 2.5 mm ²	20 - 14 AWG

9 mm

IEC60947-7-1 UL-1059

630 V	300 V		
20 A	16 A		
32 A	30 A		

0.5 Nm	4.5 lb-in		



Polyamide 6,6 / 1

6 KV / 3

Type / Cat. No.	Standard Pack
CYDLK4	50
CYDLK4BU	50
CYDLF4FT	50
CA701-1M / CA701-1M-S	50 m
CA701-15-1M / CA701-15-1M-S	25 m
CA702 / CA802 / CA202	50
CA509/K6WHT	100
SCS0.6/3.5 Blade size: 0.6 x 3.5 mm	10

Type / Cat. No.	I _{max}	Standard Pack
JX4/2	32 A	100
JX4/3	32 A	50
JX4/4	32 A	50
JX4/8	32 A	50
JX4/10	32 A	10

CYDLGK4

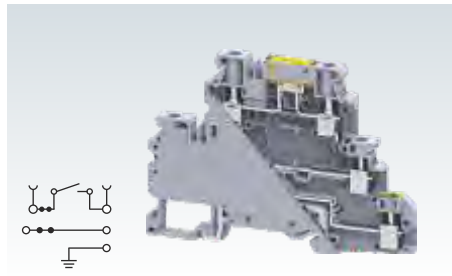

6 x 94.5 mm

67.6 mm / 75.1 mm

IEC	UL - CSA
0.2 - 4.0 mm ²	24 - 10 AWG
0.2 - 6.0 mm ²	
0.2 - 4.0 mm ²	24 - 12 AWG
0.2 - 1.5 mm ²	24 - 12 AWG
0.5 - 2.5 mm ²	24 - 14 AWG

9 mm

IEC60947-7-1 UL-1059

630 V	300 V		
20 A	16 A		
32 A	30 A		

0.5 Nm	4.5 lb-in		



Polyamide 6,6 / 1

6 KV / 3

Type / Cat. No.	Standard Pack
CYDLGK4	50
CYDLGK4BU	50
CYDLF4FT	50
CA701-1M / CA701-1M-S	50 m
CA701-15-1M / CA701-15-1M-S	25 m
CA702 / CA802 / CA202	50
CA509/K6WHT	100
SCS0.6/3.5 Blade size: 0.6 x 3.5 mm	10







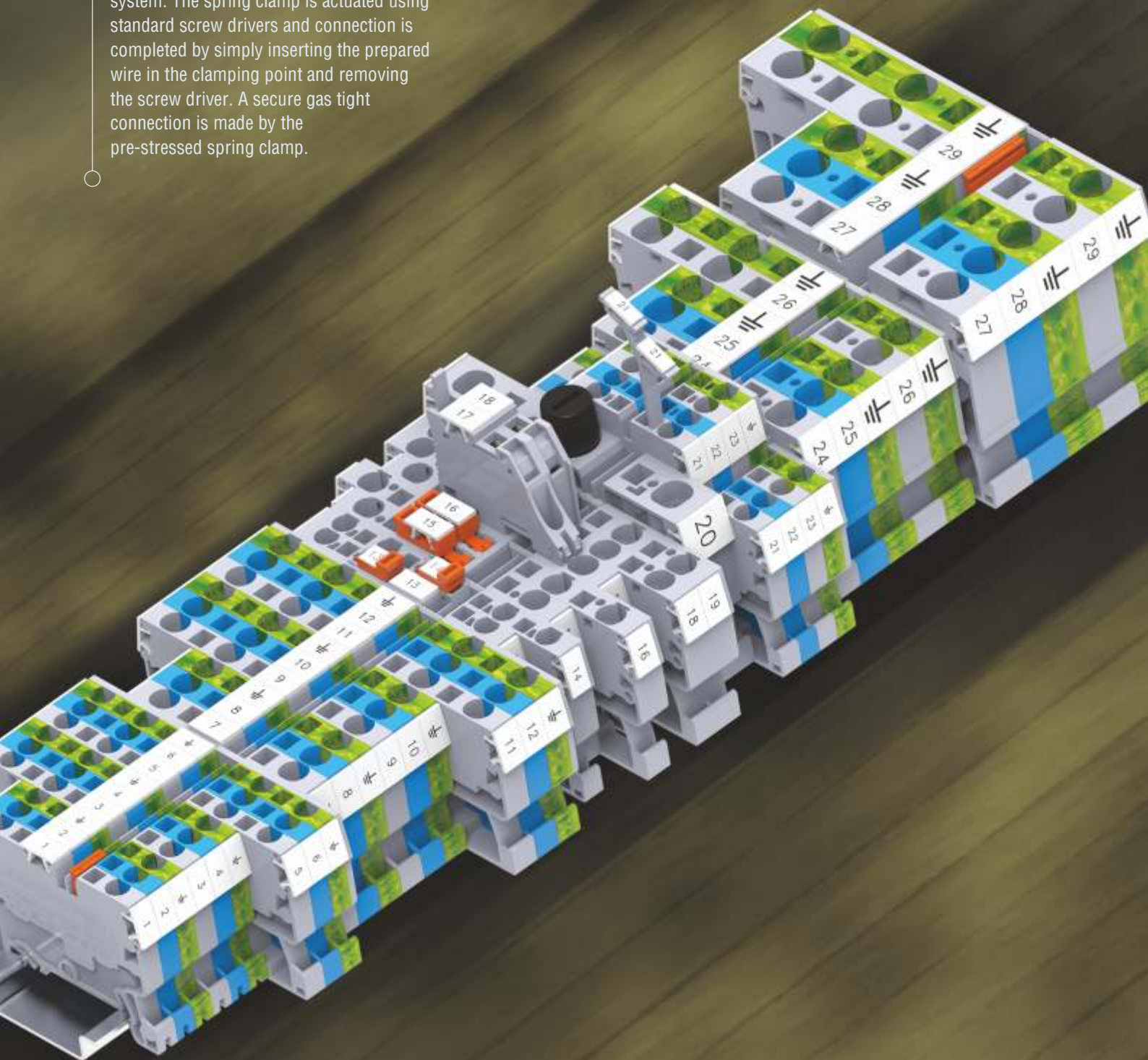







Type / Cat. No.	I _{max}	Standard Pack
JX4/2	32 A	100
JX4/3	32 A	50
JX4/4	32 A	50
JX4/8	32 A	50
JX4/10	32 A	10

CX SERIES SPRING CLAMP TERMINAL BLOCKS

The CX series Terminal Blocks have a highly reliable spring clamp connection system. The spring clamp is actuated using standard screw drivers and connection is completed by simply inserting the prepared wire in the clamping point and removing the screw driver. A secure gas tight connection is made by the pre-stressed spring clamp.



CX SERIES SPRING CLAMP TERMINAL BLOCKS

	Feed Through	95 - 97
	Multiple Connection	98 - 101
	Ground / Earth	102 - 106
	Multiple Level	107 - 110
	With Electronic Components	111 - 112
	Fuse Terminal	113 - 114
	Disconnect & Test	115 - 116
	Micro	117 - 118
	Side Entry Feed Through	119 - 120
	Side Entry Ground / Earth	120
	Hybrid Distribution	121
	Component Carrier	122
	Pluggable	123 - 127
	Angular Feed Through	129 - 132
	Angular Ground / Earth	133 - 136
	Panel Mount	137 - 140

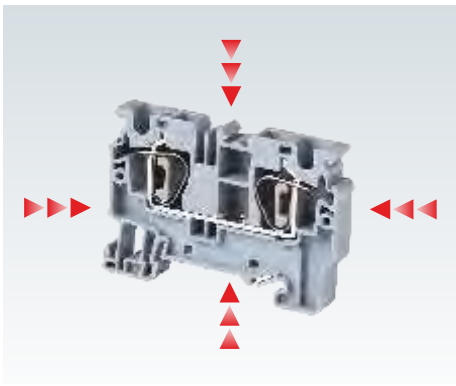

CX series Terminal Blocks have an extremely compact design. These Terminal Blocks can be used in smaller control cabinets and enclosures.



A unique design in the plastic housing of the Terminal Block facilitates ease of wire entry. Wires can be used with or without ferrules / lugs.



High quality stainless steel spring clamps provide a gas tight connection. A vibration proof, anti-loosening wire connection is achieved with this pre-stressed spring clamp system.



Partition Plates can be individually mounted on DIN rails between Terminal Blocks to provide electrical and visual separation.



Multi connection Terminal Blocks are used for applications involving more than one same potential wires to be connected.



Ground Terminal Blocks have specially designed metal alloy feet which snap on to the DIN rail. They are green-yellow colour coded as per industry norms.



Double level Terminal Blocks enable high density wiring. Each level can be independently shorted to suit various applications.



Fuse Terminal Blocks have an integral built-in end plate. They are available in various configurations including LED variants for indication fuse blow out.



Feed Through Terminal Blocks can be simultaneously shorted in an alternating configuration with Fuse & Disconnecting Terminal Blocks using pluggable jumpers.

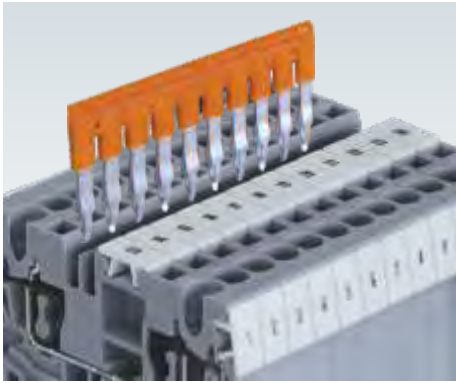

Pluggable jumpers can be inserted in the Terminal Blocks for cross connection. They are available in various pole configurations.



Specific Terminal Blocks in an assembly can be shorted by breaking intermediate contacts from the standard jumpers.



The possibility of using 2 independent rows for jumpering enables the creation of various circuit combinations. Jumpers can be marked with a felt tip pen on the recess provided on top, to clearly indicate shorted positions.



The jumper and marking tag position is aligned across different types of CX series Terminal Blocks. This facilitates shorting and marking adjacent terminals with different functionalities.



Specially designed Test Plugs are available for CX series Terminal Blocks for quick testing and measurement.



The AS series Terminal Blocks have an angled wire entry making it suitable for underfloor wiring systems. These Terminal Blocks are compact with the 2 wire, 3 wire & 4 wire terminals having the same profile.



The spring clamp knife disconnect terminal system enables isolation of circuits. A standard test plug can be used with these Terminal Blocks.



Spring clamp Terminal Blocks with electronic components are designed to meet various rectification and filtering application requirements.



Panel mounting Terminal Blocks can be easily mounted on the panel surface with the help of fixing screws. They can be interlocked to form multi-pole configurations.

FEED THROUGH TERMINAL BLOCKS

CX series Spring Clamp Terminal Blocks are the next generation, compact terminals. These series of Terminal Blocks have an improved 1000 V rating as per IEC guidelines. The new CX series terminals have a much wider range for wire terminations.

The wire is held directly against the copper current bar by pre stressed spring clamps.

Cross connection of these Terminal Blocks can be done using insulated pluggable jumpers available in various pole configurations.

Width (Thickness) x Length	5 x 50 mm			
Height with DIN 35 x 7.5 / 35 x 15 mm Rail	38 mm / 45.7 mm			
Connection Possibility as per	IEC		UL - CSA	
With 1 Conductor per clamp	Stranded / Flexible	0.2 - 2.5 mm ²	24 - 12 AWG	
	Solid	0.2 - 4.0 mm ²	24 - 10 AWG	
	with Ferrule / Lug	0.2 - 2.5 mm ²	24 - 12 AWG	
With 2 same size Conductors per clamp	with TWIN Ferrule / Lug	0.2 - 1.0 mm ²	24 - 20 AWG	
Wire Stripping Length	10 mm			
Ratings As Per	IEC60947-7-1	UL-1059	CSA22.2-158	IEC60079-7
Voltage	1000 V	600 V	600 V	630 V
Current	24 A	20 A	20 A	21 A
Approval				
Insulation Material / Material Group	Polyamide 6,6 / 1			
Rated Impulse Voltage / Pollution Degree	8 KV / 3			

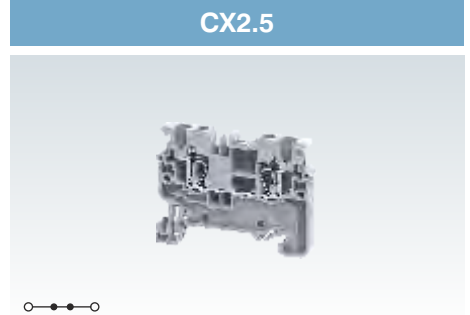

		Type / Cat. No.	Standard Pack
Terminal Block	Grey	CX2.5	100
	Blue	CX2.5BU	100
	Red	CX2.5R	100
	Yellow	CX2.5Y	100
	Black	CX2.5BK	100
	Green	CX2.5GN	100
	Orange	CX2.5O	100
	Ground / Earth	CXG2.5 (Refer Pg. 104 for Details)	100
End Plate		EPCX2.5	50
Partition Plate		PPCX4	50
Mounting Rail (Refer Pg. 217 for details)		CA701-1M / CA701-1M-S CA701-15-1M / CA701-15-1M-S	50 m 25 m
End Clamp (Refer Pg. 218 for details)		CA103 / CA104	50
Warning Label		WLX2.5	100
Marking Tags (Refer Pg. 222 for details)		CA509/K5WHT	100
Screw Driver		SCM0.5/3	Blade size: 0.5 x 3.0 mm 10

Jumpers		Type / Cat. No.	I _{max}	Standard Pack	
Pluggable Jumpers	2 pole	JX2.5/2	24 A	100	
	3 pole	JX2.5/3	24 A	50	
	4 pole	JX2.5/4	24 A	50	
	5 pole	JX2.5/5	24 A	50	
	6 pole	JX2.5/6	24 A	10	
	7 pole	JX2.5/7	24 A	10	
	8 pole	JX2.5/8	24 A	10	
	10 pole	JX2.5/10	24 A	10	
	Step Down Jumpers	4 - 2.5 mm ²	JXS4/2.5	24 A	50
		6 - 2.5 mm ²	JXS6/2.5	24 A	50
6 - 4 mm ²					
10 - 4 mm ²					
Test Plug	10 - 2.5 mm ²	JXS10/2.5	24 A	50	
		TX2.5		20	

CX4



6 x 54.8 mm
38 mm / 45.5 mm

IEC	UL - CSA
0.2 - 4.0 mm ²	24 - 10 AWG
0.2 - 6.0 mm ²	
0.2 - 4.0 mm ²	24 - 10 AWG
0.2 - 1.5 mm ²	24 - 18 AWG

10 mm
IEC60947-7-1 UL-1059 CSA22.2-158 IEC60079-7

1000 V	600 V	600 V	630 V
32 A	30 A	30 A	28 A



Polyamide 6,6 / 1
8 KV / 3

Type / Cat. No.	Standard Pack
CX4	100
CX4BU	100
CX4R	100
CX4Y	100
CX4BK	100
CX4GN	100
CX4O	100
CXG4 (Refer Pg. 105 for Details)	100
EPCX4	50
PPCX4	50
CA701-1M / CA701-1M-S	50 m
CA701-15-1M / CA701-15-1M-S	25 m
CA103 / CA104	50
WLX4	100
CA509/K6WHT	100
SCM0.5/3 Blade size: 0.5 x 3.0 mm	10

Type / Cat. No.	Imax	Standard Pack
JX4/2	32 A	100
JX4/3	32 A	50
JX4/4	32 A	50
JX4/8	32 A	10
JX4/10	32 A	10
JXS4/2.5	24 A	50
JXS6/4	32 A	50
JXS10/4	32 A	50

CX6



8 x 62.1 mm
43 mm / 50.5 mm

IEC	UL - CSA
0.2 - 6.0 mm ²	24 - 8 AWG
0.2 - 6.0 mm ²	
0.2 - 6.0 mm ²	24 - 8 AWG
0.2 - 1.5 mm ²	24 - 16 AWG

14 mm
IEC60947-7-1 UL-1059 CSA22.2-158 IEC60079-7

1000 V	600 V	600 V	630 V
41 A	50 A	50 A	36 A



Polyamide 6,6 / 1
8 KV / 3

Type / Cat. No.	Standard Pack
CX6	100
CX6BU	100
CX6R	100
CX6Y	100
CX6BK	100
CX6GN	100
CX6O	100
CXG6 (Refer Pg. 105 for Details)	100
EPCX6	50
PPCX10	20
CA701-1M / CA701-1M-S	50 m
CA701-15-1M / CA701-15-1M-S	25 m
CA103 / CA104	50
WLX6	50
CA509/K8WHT	100
SCM0.8/4 Blade size: 0.8 x 4 mm	10

Type / Cat. No.	Imax	Standard Pack
JX6/2	41 A	100
JX6/3	41 A	50
JX6/4	41 A	50
JX6/10	41 A	10
JXS6/2.5	24 A	50
JXS6/4	32 A	50
JXS10/6	41 A	50

CX10



10 x 71.7 mm
49.5 mm / 57 mm

IEC	UL - CSA
0.2 - 10.0 mm ²	24 - 6 AWG
0.2 - 10.0 mm ²	
0.2 - 10.0 mm ²	24 - 6 AWG
1.5 - 4.0 mm ²	

18 mm
IEC60947-7-1 UL-1059 CSA22.2-158 IEC60079-7

1000 V	600 V	600 V	630 V
57 A	65 A	65 A	51 A



Polyamide 6,6 / 1
8 KV / 3

Type / Cat. No.	Standard Pack
CX10	50
CX10BU	50
CX10R	50
CX10Y	50
CX10BK	50
CX10GN	50
CX10O	50
CXG10 (Refer Pg. 106 for Details)	50
EPCX10	50
PPCX10	20
CA701-1M / CA701-1M-S	50 m
CA701-15-1M / CA701-15-1M-S	25 m
CA103 / CA104	50
WLX10	50
CA509/K10WHT	100
SCM0.8/4 Blade size: 0.8 x 4 mm	10

Type / Cat. No.	Imax	Standard Pack
JX10/2	57 A	20
JXS10/6	41 A	50
JXS10/4	32 A	50
JXS10/2.5	24 A	50

FEED THROUGH TERMINAL BLOCKS

In Spring Clamp Terminal Blocks the wire is held directly against the current bar by pre-stressed spring clamps.

The spring clamp is operated by using a screw driver to provide an access to the wire through an opening in the spring clamp. The inserted wire gets clamped on to the current bar when the screw driver is removed.

Cross Connection is done with Insulated Push-in / wire type shorting links.

Step Down Jumpers are used for shorting spring clamp Terminal Blocks of different sizes. For more details refer page 233.

Width (Thickness) x Length	12 x 82 mm																		
Height with DIN 35 x 7.5 / 35 x 15 mm Rail	51.6 mm / 59.0 mm																		
Connection Possibility as per	<table border="1"> <thead> <tr> <th>IEC</th> <th colspan="2">UL - CSA</th> </tr> </thead> <tbody> <tr> <td>With 1 Conductor per clamp</td> <td>1.5 - 16.0 mm²</td> <td>16 - 4 AWG</td> </tr> <tr> <td>Stranded / Flexible</td> <td rowspan="2">1.5 - 16.0 mm²</td> <td rowspan="2">16 - 4 AWG</td> </tr> <tr> <td>Solid with Ferrule / Lug</td> </tr> <tr> <td>With 2 same size Conductors per clamp</td> <td>1.5 - 10.0 mm²</td> <td>16 - 8 AWG</td> </tr> <tr> <td>with TWIN Ferrule / Lug</td> <td colspan="2"></td> </tr> </tbody> </table>			IEC	UL - CSA		With 1 Conductor per clamp	1.5 - 16.0 mm ²	16 - 4 AWG	Stranded / Flexible	1.5 - 16.0 mm ²	16 - 4 AWG	Solid with Ferrule / Lug	With 2 same size Conductors per clamp	1.5 - 10.0 mm ²	16 - 8 AWG	with TWIN Ferrule / Lug		
IEC	UL - CSA																		
With 1 Conductor per clamp	1.5 - 16.0 mm ²	16 - 4 AWG																	
Stranded / Flexible	1.5 - 16.0 mm ²	16 - 4 AWG																	
Solid with Ferrule / Lug																			
With 2 same size Conductors per clamp	1.5 - 10.0 mm ²	16 - 8 AWG																	
with TWIN Ferrule / Lug																			
Wire Stripping Length	20 mm																		
Ratings As Per	IEC60947-7-1	UL-1059	CSA22.2-158																
Voltage	800 V	600 V	600 V																
Current	76 A	85 A	85 A																
Approvals																			
Insulation Material / Material Group	Polyamide 6,6 / 1																		
Rated Impulse Voltage / Pollution Degree	8 KV / 3																		



		Type / Cat. No.	Standard Pack
Terminal Block	Grey	CSC16T	50
	Blue	CSC16TBU	50
	Red	CSC16TR	50
	Yellow	CSC16TY	50
	Black	CSC16TBK	50
	Green	CSC16TGN	50
	Ground / Earth	CSCG16T (Refer Pg. 106 for Details)	50
End Plate		EPCSC16T	50
Mounting Rail (Refer Pg. 217 for details)		CA701-1M / CA701-1M-S	50 m
CA701-15-1M / CA701-15-1M-S			25 m
End Clamp (Refer Pg. 218 for details)		CA103 / CA104	50
Marking Tags (Refer Pg. 222 for details)		CA509/K12WHT	100
Screw Driver		SCM1/5.5 Blade size: 1.0 x 5.5 mm	10

Jumpers		Type / Cat. No.	I _{max}	Standard Pack
	2 Pole	CA801/5	76 A	100

MULTIPLE CONNECTION TERMINAL BLOCKS

CX series multi connect 3 wire & 4 wire spring clamp Terminal Blocks are used to eliminate reliability problems encountered when there is a need to connect multiple wires in a single Terminal Block.

CX2.5/4P is a double potential Terminal Block. It allows two different system voltages to be run through the same terminal block. One side of the Terminal Block can be shorted with standard insulated push-in jumpers.

Width (Thickness) x Length	5 x 62.5 mm			
Height with DIN 35 x 7.5 / 35 x 15 mm Rail	38 mm / 45.7 mm			
Connection Possibility as per	IEC		UL - CSA	
With 1 Conductor per clamp	Stranded / Flexible	0.2 - 2.5 mm ²	24 - 12 AWG	
	Solid	0.2 - 4.0 mm ²	24 - 10 AWG	
	with Ferrule / Lug	0.2 - 2.5 mm ²	24 - 12 AWG	
With 2 same size Conductors per clamp	with TWIN Ferrule / Lug	0.2 - 1.0 mm ²	24 - 20 AWG	
Wire Stripping Length	10 mm			
Ratings As Per	IEC60947-7-1	UL-1059	CSA22.2-158	IEC60079-7
Voltage	1000 V	600 V	600 V	630 V
Current	24 A	20 A	20 A	21 A
Approval				
Insulation Material / Material Group	Polyamide 6,6 / 1			
Rated Impulse Voltage / Pollution Degree	8 KV / 3			



		Type / Cat. No.	Standard Pack
Terminal Block	Grey	CX2.5/3	100
	Blue	CX2.5/3BU	100
	Red	CX2.5/3R	100
	Yellow	CX2.5/3Y	100
	Black	CX2.5/3BK	100
	Green	CX2.5/3GN	100
	Orange	CX2.5/3O	100
	Ground / Earth	CXG2.5/3 (Refer Pg. 106 for Details)	100
End Plate		EPCX2.5/3	50
Partition Plate		PPCX4/3	50
Mounting Rail (Refer Pg. 217 for details)		CA701-1M / CA701-1M-S	50 m
		CA701-15-1M / CA701-15-1M-S	25 m
End Clamp (Refer Pg. 218 for details)		CA103 / CA104	50
Warning Label		WLX2.5	100
Marking Tags (Refer Pg. 222 for details)		CA509/K5WHT	100
Screw Driver		SCM0.5/3 Blade size: 0.5 x 3.0 mm	10

Jumpers		Type / Cat. No.	I _{max}	Standard Pack
Pluggable Jumpers	2 pole	JX2.5/2	24 A	100
	3 pole	JX2.5/3	24 A	50
	4 pole	JX2.5/4	24 A	50
	5 pole	JX2.5/5	24 A	50
	6 pole	JX2.5/6	24 A	10
	7 pole	JX2.5/7	24 A	10
	8 pole	JX2.5/8	24 A	10
	10 pole	JX2.5/10	24 A	10
	16 pole			
	Step Down Jumpers	4 - 2.5 mm ²	JXS4/2.5	24 A
6 - 2.5 mm ²		JXS6/2.5	24 A	50
10 - 2.5 mm ²		JXS10/2.5	24 A	50
Test Plug		TX2.5		20

CX2.5/4



CX2.5/4P

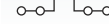

Width (Thickness) x Length		5 x 74.7 mm	
Height with DIN 35 x 7.5 / 35 x 15 mm Rail		38 mm / 45.7 mm	
Connection Possibility as per		IEC	UL - CSA
With 1 Conductor per clamp	Stranded / Flexible	0.2 - 2.5 mm ²	24 - 12 AWG
	Solid	0.2 - 4.0 mm ²	24 - 10 AWG
	with Ferrule / Lug	0.2 - 2.5 mm ²	24 - 12 AWG
With 2 same size Conductors per clamp	with TWIN Ferrule / Lug	0.2 - 1.0 mm ²	24 - 20 AWG
Wire Stripping Length		10 mm	
Ratings As Per		IEC60947-7-1	UL-1059 CSA22.2-158 IEC60079-7
Voltage		1000 V	600 V 600 V 630 V
Current		24 A	20 A 20 A 21 A
Approval			
Insulation Material / Material Group		Polyamide 6,6 / 1	
Rated Impulse Voltage / Pollution Degree		8 KV / 3	

Width (Thickness) x Length		5 x 74.7 mm	
Height with DIN 35 x 7.5 / 35 x 15 mm Rail		38 mm / 45.7 mm	
Connection Possibility as per		IEC	UL - CSA
With 1 Conductor per clamp	Stranded / Flexible	0.2 - 2.5 mm ²	24 - 12 AWG
	Solid	0.2 - 4.0 mm ²	24 - 10 AWG
	with Ferrule / Lug	0.2 - 2.5 mm ²	24 - 12 AWG
With 2 same size Conductors per clamp	with TWIN Ferrule / Lug	0.2 - 0.5 mm ²	24 - 20 AWG
Wire Stripping Length		10 mm	
Ratings As Per		IEC60947-7-1	UL-1059 CSA22.2-158
Voltage		1000 V	600 V 600 V
Current		24 A	20 A 20 A
Approval			
Insulation Material / Material Group		Polyamide 6,6 / 1	
Rated Impulse Voltage / Pollution Degree		8 KV / 3	

	Type / Cat. No.	Standard Pack
Terminal Block	Grey	CX2.5/4 100
	Blue	CX2.5/4BU 100
	Red	CX2.5/4R 100
	Yellow	CX2.5/4Y 100
	Black	CX2.5/4BK 100
	Green	CX2.5/4GN 100
	Orange	CX2.5/4O 100
	Ground / Earth	CXG2.5/4 (Refer Pg. 107 for Details) 100
End Plate	EPCX2.5/4	50
Partition Plate	PPCX4/4	50
Mounting Rail (Refer Pg. 217 for details)	CA701-1M / CA701-1M-S	50 m
	CA701-15-1M / CA701-15-1M-S	25 m
End Clamp (Refer Pg. 218 for details)	CA103 / CA104	50
Warning Label	WLX2.5	100
Marking Tags (Refer Pg. 222 for details)	CA509/K5WHT	100
Screw Driver	SCM0.5/3 Blade size: 0.5 x 3.0 mm	10

	Type / Cat. No.	Standard Pack
Terminal Block	Grey	CX2.5/4P 100
	Blue	CX2.5/4PBU 100
	Red	CX2.5/4PR 100
	Yellow	CX2.5/4PY 100
	Black	CX2.5/4PBK 100
	Green	CX2.5/4PGN 100
	Orange	CX2.5/4PO 100
	Ground / Earth	CXG2.5/4P (Refer Pg. 107 for Details) 100
End Plate	EPCX2.5/4	50
Partition Plate	PPCX4/4	50
Mounting Rail (Refer Pg. 217 for details)	CA701-1M / CA701-1M-S	50 m
	CA701-15-1M / CA701-15-1M-S	25 m
End Clamp (Refer Pg. 218 for details)	CA103 / CA104	50
Warning Label	WLX2.5	100
Marking Tags (Refer Pg. 222 for details)	CA509/K5WHT	100
Screw Driver	SCM0.5/3 Blade size: 0.5 x 3.0 mm	10

Jumpers	Type / Cat. No.	Imax	Standard Pack	
Pluggable Jumpers	2 pole	JX2.5/2 24 A	100	
	3 pole	JX2.5/3 24 A	50	
	4 pole	JX2.5/4 24 A	50	
	5 pole	JX2.5/5 24 A	50	
	6 pole	JX2.5/6 24 A	10	
	7 pole	JX2.5/7 24 A	10	
	8 pole	JX2.5/8 24 A	10	
	10 pole	JX2.5/10 24 A	10	
	Step Down Jumpers	4 - 2.5 mm ²	JXS4/2.5 24 A	50
		6 - 2.5 mm ²	JXS6/2.5 24 A	50
6 - 4 mm ²				
10 - 6 mm ²				
10 - 4 mm ²				
	JXS10/2.5	24 A	50	
Test Plug	TX2.5		20	

Jumpers	Type / Cat. No.	Imax	Standard Pack	
Pluggable Jumpers	2 pole	JX2.5/2 24 A	100	
	3 pole	JX2.5/3 24 A	50	
	4 pole	JX2.5/4 24 A	50	
	5 pole	JX2.5/5 24 A	50	
	6 pole	JX2.5/6 24 A	10	
	7 pole	JX2.5/7 24 A	10	
	8 pole	JX2.5/8 24 A	10	
	10 pole	JX2.5/10 24 A	10	
	Step Down Jumpers	4 - 2.5 mm ²	JXS4/2.5 24 A	50
		6 - 2.5 mm ²	JXS6/2.5 24 A	50
6 - 4 mm ²				
10 - 6 mm ²				
10 - 4 mm ²				
	JXS10/2.5	24 A	50	
Test Plug	TX2.5		20	

Width (Thickness) x Length		5 x 74.7 mm	
Height with DIN 35 x 7.5 / 35 x 15 mm Rail		38 mm / 45.7 mm	
Connection Possibility as per		IEC	UL - CSA
With 1 Conductor per clamp	Stranded / Flexible	0.2 - 2.5 mm ²	24 - 12 AWG
	Solid	0.2 - 4.0 mm ²	24 - 10 AWG
	with Ferrule / Lug	0.2 - 2.5 mm ²	24 - 12 AWG
With 2 same size Conductors per clamp	with TWIN Ferrule / Lug	0.2 - 0.5 mm ²	24 - 20 AWG
Wire Stripping Length		10 mm	
Ratings As Per		IEC60947-7-1	UL-1059 CSA22.2-158
Voltage		1000 V	600 V 600 V
Current		24 A	20 A 20 A
Approval			
Insulation Material / Material Group		Polyamide 6,6 / 1	
Rated Impulse Voltage / Pollution Degree		8 KV / 3	

	Type / Cat. No.	Standard Pack
Terminal Block	Grey	CX2.5/4P 100
	Blue	CX2.5/4PBU 100
	Red	CX2.5/4PR 100
	Yellow	CX2.5/4PY 100
	Black	CX2.5/4PBK 100
	Green	CX2.5/4PGN 100
	Orange	CX2.5/4PO 100
	Ground / Earth	CXG2.5/4P (Refer Pg. 107 for Details) 100
End Plate	EPCX2.5/4	50
Partition Plate	PPCX4/4	50
Mounting Rail (Refer Pg. 217 for details)	CA701-1M / CA701-1M-S	50 m
	CA701-15-1M / CA701-15-1M-S	25 m
End Clamp (Refer Pg. 218 for details)	CA103 / CA104	50
Warning Label	WLX2.5	100
Marking Tags (Refer Pg. 222 for details)	CA509/K5WHT	100
Screw Driver	SCM0.5/3 Blade size: 0.5 x 3.0 mm	10

Jumpers	Type / Cat. No.	Imax	Standard Pack	
Pluggable Jumpers	2 pole	JX2.5/2 24 A	100	
	3 pole	JX2.5/3 24 A	50	
	4 pole	JX2.5/4 24 A	50	
	5 pole	JX2.5/5 24 A	50	
	6 pole	JX2.5/6 24 A	10	
	7 pole	JX2.5/7 24 A	10	
	8 pole	JX2.5/8 24 A	10	
	10 pole	JX2.5/10 24 A	10	
	Step Down Jumpers	4 - 2.5 mm ²	JXS4/2.5 24 A	50
		6 - 2.5 mm ²	JXS6/2.5 24 A	50
6 - 4 mm ²				
10 - 6 mm ²				
10 - 4 mm ²				
	JXS10/2.5	24 A	50	
Test Plug	TX2.5		20	

CX4/3



6 x 70.5 mm
38 mm / 45.5 mm

IEC	UL - CSA
0.2 - 4.0 mm ²	24 - 10 AWG
0.2 - 6.0 mm ²	24 - 8 AWG
0.2 - 4.0 mm ²	24 - 10 AWG
0.2 - 1.0 mm ²	24 - 18 AWG

10 mm

IEC60947-7-1	UL-1059	CSA22.2-158	IEC60079-7
1000 V	600 V	600 V	630 V
32 A	30 A	30 A	28 A



Polyamide 6,6 / 1
8 KV / 3

CX4/4



6 x 86.2 mm
38 mm / 45.5 mm

IEC	UL - CSA
0.2 - 4.0 mm ²	24 - 10 AWG
0.2 - 6.0 mm ²	24 - 8 AWG
0.2 - 4.0 mm ²	24 - 10 AWG
0.2 - 1.0 mm ²	24 - 18 AWG

10 mm

IEC60947-7-1	UL-1059	CSA22.2-158	IEC60079-7
1000 V	600 V	600 V	630 V
32 A	30 A	30 A	28 A



Polyamide 6,6 / 1
8 KV / 3

CX6/3

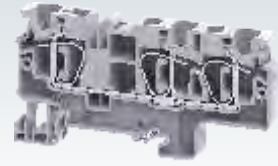

8 x 82.2 mm
43 mm / 50.5 mm

IEC	UL - CSA
0.2 - 6.0 mm ²	24 - 8 AWG
0.2 - 6.0 mm ²	24 - 8 AWG
0.2 - 1.5 mm ²	24 - 16 AWG

14 mm

IEC60947-7-1	UL-1059	CSA22.2-158	IEC60079-7
1000 V	600 V	600 V	630 V
41 A	50 A	50 A	36 A

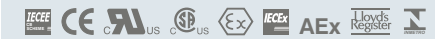

Polyamide 6,6 / 1
8 KV / 3

Type / Cat. No.	Standard Pack
CX4/3	50
CX4/3BU	50
CX4/3R	50
CX4/3Y	50
CX4/3BK	50
CX4/3GN	50
CX4/3O	50
CXG4/3 (Refer Pg. 107 for Details)	50
EPCX4/3	50
PPCX4/3	50
CA701-1M / CA701-1M-S	50 m
CA701-15-1M / CA701-15-1M-S	25 m
CA103 / CA104	50
WLX4	50
CA509/K5WHT	100
SCM0.6/3.5 Blade size: 0.6 x 3.5 mm	10

Type / Cat. No.	Standard Pack
CX4/4	50
CX4/4BU	50
CX4/4R	50
CX4/4Y	50
CX4/4BK	50
CX4/4GN	50
CX4/4O	50
CXG4/4 (Refer Pg. 108 for Details)	50
EPCX4/4	50
PPCX4/4	50
CA701-1M / CA701-1M-S	50 m
CA701-15-1M / CA701-15-1M-S	25 m
CA103 / CA104	50
WLX4	50
CA509/K6WHT	100
SCM0.6/3.5 Blade size: 0.6 x 3.5 mm	10

Type / Cat. No.	Standard Pack
CX6/3	50
CX6/3BU	50
CX6/3R	50
CX6/3Y	50
CX6/3BK	50
CX6/3GN	50
CX6/3O	50
CXG6/3 (Refer Pg. 108 for Details)	50
EPCX6/3	50
CA701-1M / CA701-1M-S	50 m
CA701-15-1M / CA701-15-1M-S	25 m
CA103 / CA104	50
WLX6	50
CA509/K8WHT	100
SCM0.8/4 Blade size: 0.8 x 4 mm	10

Type / Cat. No.	Imax	Standard Pack
JX4/2	32 A	100
JX4/3	32 A	50
JX4/4	32 A	50
JX4/8	32 A	10
JX4/10	32 A	10
JXS4/2.5	24 A	50
JXS6/4	32 A	50
JXS10/4	32 A	50

Type / Cat. No.	Imax	Standard Pack
JX4/2	32 A	100
JX4/3	32 A	50
JX4/4	32 A	50
JX4/8	32 A	10
JX4/10	32 A	10
JXS4/2.5	24 A	50
JXS6/4	32 A	50
JXS10/4	32 A	50

Type / Cat. No.	Imax	Standard Pack
JX6/2	41 A	100
JX6/3	41 A	50
JX6/4	41 A	50
JX6/10	41 A	10
JXS6/2.5	34 A	50
JXS6/4	32 A	50
JXS10/6	41 A	50

CX10/3



CSC16/3T

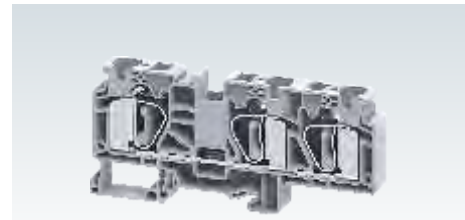

Width (Thickness) x Length	10 x 97.6 mm	
Height with DIN 35 x 7.5 / 35 x 15 mm Rail	49.3 mm / 56.8 mm	
Connection Possibility as per	IEC	
With 1 Conductor per clamp	Stranded / Flexible	0.2 - 10.0 mm ²
	Solid with Ferrule / Lug	0.2 - 10.0 mm ²
With 2 same size Conductors per clamp	with TWIN Ferrule / Lug	1.5 - 4.0 mm ²
Wire Stripping Length	18 mm	
Ratings As Per	IEC60947-7-1 UL-1059 IEC60079-7	
Voltage	1000 V 600 V 630 V	
Current	57 A 65 A 51 A	
Approval		
Insulation Material / Material Group	Polyamide 6,6 / 1	
Rated Impulse Voltage / Pollution Degree	8 KV / 3	

Width (Thickness) x Length	12 x 120 mm	
Height with DIN 35 x 7.5 / 35 x 15 mm Rail	51.6 mm / 59.0 mm	
Connection Possibility as per	IEC	
With 1 Conductor per clamp	Stranded / Flexible	1.5 - 16.0 mm ²
	Solid with Ferrule / Lug	1.5 - 16.0 mm ²
With 2 same size Conductors per clamp	with TWIN Ferrule / Lug	1.5 - 10.0 mm ²
Wire Stripping Length	20 mm	
Ratings As Per	IEC60947-7-1 UL-1059 CSA22.2-158	
Voltage	800 V 600 V 600 V	
Current	76 A 85 A 85 A	
Approval		
Insulation Material / Material Group	Polyamide 6,6 / 1	
Rated Impulse Voltage / Pollution Degree	8 KV / 3	

Terminal Block	<ul style="list-style-type: none"> Grey Blue Red Yellow Black Green Orange Ground / Earth
End Plate	
Mounting Rail (Refer Pg. 217 for details)	
End Clamp (Refer Pg. 218 for details)	
Warning Label	
Marking Tags (Refer Pg. 222 for details)	
Screw Driver	

Type / Cat. No.	Standard Pack
CX10/3	50
CX10/3BU	50
CX10/3R	50
CX10/3Y	50
CX10/3BK	50
CX10/3GN	50
CX10/3O	50
CXG10/3 (Refer Pg. 108 for Details)	50
EPCX10/3	20
CA701-1M / CA701-1M-S	50 m
CA701-15-1M / CA701-15-1M-S	25 m
CA103 / CA104	50
WLX10	50
CA509/K10WHT	100
SCM0.8/4 Blade size: 0.8 x 4 mm	10

Type / Cat. No.	Standard Pack
CSC16/3T	50
CSC16/3TBU	50
	50
	50
	50
	50
	50
CSCG16/3T	50
EPCSC16/3T	50
CA701-1M / CA701-1M-S	50 m
CA701-15-1M / CA701-15-1M-S	25 m
CA103 / CA104	50
CA509/K12WHT	100
SCM1/5.5 Blade size: 1.0 x 5.5 mm	10

Jumpers	Type / Cat. No.	I _{max}	Standard Pack
	JX10/2	57 A	20
Step Down Jumpers	JXS10/2.5	24 A	50
	JXS10/4	32 A	50
	JXS10/6	41 A	50

Type / Cat. No.	I _{max}	Standard Pack
JX10/2	57 A	20
JXS10/2.5	24 A	50
JXS10/4	32 A	50
JXS10/6	41 A	50

Type / Cat. No.	I _{max}	Standard Pack
CA801/5 (For CSC16/3T)	76 A	100

CSCG16/3T

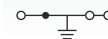
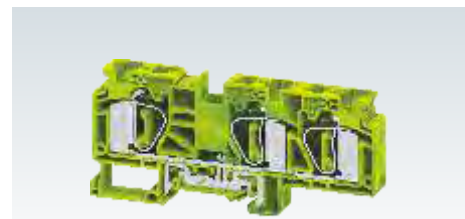

GROUND / EARTH TERMINAL BLOCKS

CXG series are compact spring clamp earthing Terminal Blocks with specially designed alloy feet which help in achieving very low contact resistance and vibration proof grounding with the DIN rails. They are Green-Yellow colour coded as per industry standards.

Cross connection of these Terminal Blocks can be done using pluggable jumpers.

Multi connect 3 wire & 4 wire terminals eliminate reliability problems encountered when there is a need to connect multiple wires in a single Terminal Block.

CXG2.5

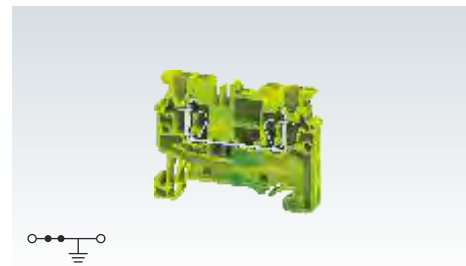

Width (Thickness) x Length	5 x 50 mm			
Height with DIN 35 x 7.5 / 35 x 15 mm Rail	38 mm / 45.7 mm			
Connection Possibility as per	IEC	UL - CSA		
	With 1 Conductor per clamp	Stranded / Flexible	0.2 - 2.5 mm ²	24 - 12 AWG
	Solid	0.2 - 4.0 mm ²	24 - 10 AWG	
With 2 same size Conductors per clamp	with Ferrule / Lug	0.2 - 2.5 mm ²	24 - 12 AWG	
Wire Stripping Length	with TWIN Ferrule / Lug	0.2 - 1.0 mm ²	24 - 20 AWG	
Approval	10 mm			
Insulation Material / Material Group				
Rated Impulse Voltage / Pollution Degree	Polyamide 6,6 / 1			
	8 KV / 3			

	Type / Cat. No.	Standard Pack
Terminal Block	CXG2.5	100
End Plate	EPCX2.5	50
Partition Plate	PPCX4	50
Mounting Rail (Refer Pg. 217 for details)	CA701-1M / CA701-1M-S	50 m
	CA701-15-1M / CA701-15-1M-S	25 m
End Clamp (Refer Pg. 218 for details)	CA103 / CA104	50
Warning Label	WLX2.5	100
Marking Tags (Refer Pg. 222 for details)	CA509/K5WHT	100
Screw Driver	SCM0.5/3 Blade size: 0.5 x 3.0 mm	10

Jumpers		Type / Cat. No.	I _{max}	Standard Pack
Pluggable Jumpers	2 pole	JX2.5/2	24 A	100
	3 pole	JX2.5/3	24 A	50
	4 pole	JX2.5/4	24 A	50
	5 pole	JX2.5/5	24 A	50
	6 pole	JX2.5/6	24 A	10
	7 pole	JX2.5/7	24 A	10
	8 pole	JX2.5/8	24 A	10
	10 pole	JX2.5/10	24 A	10
Step Down Jumpers	4 - 2.5 mm ²	JXS4/2.5	24 A	50
	6 - 2.5 mm ²	JXS6/2.5	24 A	50
	10 - 2.5 mm ²	JXS10/2.5	24 A	50
Test Plug	TX2.5		20	

CXG4



CXG6



Width (Thickness) x Length	6 x 54.8 mm	
Height with DIN 35 x 7.5 / 35 x 15 mm Rail	38 mm / 45.5 mm	
Connection Possibility as per	IEC	
With 1 Conductor per clamp	Stranded / Flexible	0.2 - 4.0 mm ²
	Solid	0.2 - 6.0 mm ²
	with Ferrule / Lug	0.2 - 4.0 mm ²
With 2 same size Conductors per clamp	with TWIN Ferrule / Lug	0.2 - 1.0 mm ²
Wire Stripping Length	10 mm	
Approval		
Insulation Material / Material Group	Polyamide 6,6 / 1	
Rated Impulse Voltage / Pollution Degree	8 KV / 3	

	UL - CSA
	24 - 10 AWG
	24 - 10 AWG
	24 - 18 AWG

	UL - CSA
	24 - 8 AWG
	24 - 8 AWG
	24 - 16 AWG

Terminal Block	CXG4	Standard Pack	100
End Plate	EPCX4		50
Partition Plate	PPCX4		50
Mounting Rail (Refer Pg. 217 for details)	CA701-1M / CA701-1M-S		50 m
	CA701-15-1M / CA701-15-1M-S		25 m
End Clamp (Refer Pg. 218 for details)	CA103 / CA104		50
Warning Label	WLX4		100
Marking Tags (Refer Pg. 222 for details)	CA509/K6WHT		100
Screw Driver	SCM0,5/3	Blade size: 0.5 x 3.0 mm	10

	Standard Pack	
		100
		50
		50
		50 m
		25 m
		50
		100
		100
		10

	Standard Pack	
		100
		50
		20
		50 m
		25 m
		50
		50
		100
		10

Jumpers				
Pluggable Jumpers	2 pole	JX4/2	32 A	
	3 pole	JX4/3	32 A	
	4 pole	JX4/4	32 A	
	5 pole			
	6 pole			
	7 pole			
	8 pole	JX4/8	32 A	
	10 pole	JX4/10	32 A	
	Step Down Jumpers	4 - 2.5 mm ²	JXS4/2.5	24 A
		6 - 2.5 mm ²		
6 - 4 mm ²		JXS6/4	32 A	
10 - 6 mm ²				
10 - 4 mm ²		JXS10/4	32 A	
Test Plug				

	Imax	Standard Pack
		100
		50
		50
		10
		10
		50
		10
		50
		50
		50

	Imax	Standard Pack
		100
		50
		50
		10
		50
		50
		50

CXG10



10 x 71.7 mm
49.5 mm / 57 mm

IEC	UL - CSA
0.2 - 10.0 mm ²	24 - 6 AWG
0.2 - 10.0 mm ²	24 - 6 AWG
1.5 - 2.5 mm ²	

18 mm



Polyamide 6,6 / 1
8 KV / 3

Type / Cat. No.	Standard Pack
CXG10	50
EPCX10	50
PPCX10	20
CA701-1M / CA701-1M-S	50 m
CA701-15-1M / CA701-15-1M-S	25 m
CA103 / CA104	50
WLX10	50
CA509/K10WHT	100
SCM0.8/4 Blade size: 0.8 x 4 mm	10

Type / Cat. No.	Imax	Standard Pack
JX10/2	57 A	20
JXS10/6	41 A	50
JXS10/4	32 A	50
JXS10/2.5	24 A	50

CSCG16T



12 x 82 mm
51.6 mm / 59.0 mm

IEC	UL - CSA
1.5 - 16.0 mm ²	16 - 4 AWG
1.5 - 16.0 mm ²	16 - 4 AWG
1.5 - 10.0 mm ²	16 - 8 AWG

20 mm



Polyamide 6,6 / 1
8 KV / 3

Type / Cat. No.	Standard Pack
CSCG16T	50
EPCSC16T	50
CA701-1M / CA701-1M-S	50 m
CA701-15-1M / CA701-15-1M-S	25 m
CA509/K12WHT	100
SCM1.0/5.5 Blade size: 1.0 x 5.5 mm	10

Type / Cat. No.	Imax	Standard Pack

CXG2.5/3

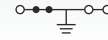

5 x 62.5 mm
38 mm / 45.5 mm

IEC	UL - CSA
0.2 - 2.5 mm ²	24 - 12 AWG
0.2 - 4.0 mm ²	24 - 10 AWG
0.2 - 2.5 mm ²	24 - 12 AWG
0.2 - 1.0 mm ²	24 - 20 AWG

10 mm



Polyamide 6,6 / 1
8 KV / 3

Type / Cat. No.	Standard Pack
CXG2.5/3	100
EPCX2.5/3	50
PPCX4/3	50
CA701-1M / CA701-1M-S	50 m
CA701-15-1M / CA701-15-1M-S	25 m
CA103 / CA104	50
WLX2.5	100
CA509/K5WHT	100
SCM0.5/3 Blade size: 0.5 x 3.0 mm	10

Type / Cat. No.	Imax	Standard Pack
JX2.5/2	24 A	100
JX2.5/3	24 A	50
JX2.5/4	24 A	50
JX2.5/5	24 A	50
JX2.5/6	24 A	10
JX2.5/7	24 A	10
JX2.5/8	24 A	10
JX2.5/10	24 A	10
JXS4/2.5	24 A	50
JXS6/2.5	24 A	50
JXS10/2.5	24 A	50
TX2.5		20

CXG2.5/4

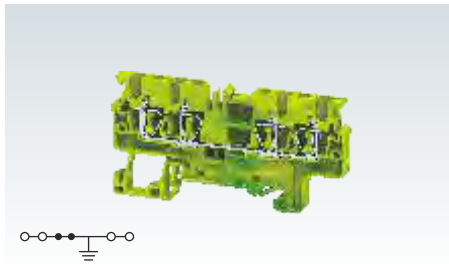

CXG4/3

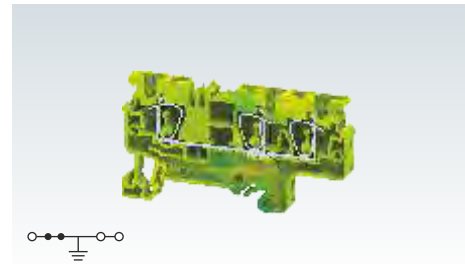

Width (Thickness) x Length	5 x 74.7 mm	
Height with DIN 35 x 7.5 / 35 x 15 mm Rail	38 mm / 45.5 mm	
Connection Possibility as per		
With 1 Conductor per clamp	Stranded / Flexible	0.2 - 2.5 mm ²
	Solid	0.2 - 4.0 mm ²
	with Ferrule / Lug	0.2 - 2.5 mm ²
With 2 same size Conductors per clamp	with TWIN Ferrule / Lug	0.2 - 1.0 mm ²
Wire Stripping Length	10 mm	

IEC	UL - CSA
0.2 - 2.5 mm ²	24 - 12 AWG
0.2 - 4.0 mm ²	24 - 10 AWG
0.2 - 2.5 mm ²	24 - 12 AWG
0.2 - 1.0 mm ²	24 - 20 AWG
10 mm	

IEC	UL - CSA
0.2 - 4.0 mm ²	24 - 10 AWG
0.2 - 6.0 mm ²	
0.2 - 4.0 mm ²	24 - 10 AWG
0.2 - 1.0 mm ²	24 - 18 AWG
10 mm	

Approval	
Insulation Material / Material Group	Polyamide 6,6 / 1
Rated Impulse Voltage / Pollution Degree	8 KV / 3

IECEE	CE	UL	AEx	Lloyds Register
IEC	UL - CSA	IECEx	AEx	Lloyds Register
Polyamide 6,6 / 1				
8 KV / 3				

IECEE	CE	UL	AEx	Lloyds Register
IEC	UL - CSA	IECEx	AEx	Lloyds Register
Polyamide 6,6 / 1				
8 KV / 3				

	Type / Cat. No.	Standard Pack
Terminal Block	CXG2.5/4	100
End Plate	EPCX2.5/4	50
Partition Plate	PPCX4/4	50
Mounting Rail (Refer Pg. 217 for details)	CA701-1M / CA701-1M-S	50 m
	CA701-15-1M / CA701-15-1M-S	25 m
End Clamp (Refer Pg. 218 for details)	CA103 / CA104	50
Warning Label	WLX2.5	100
Marking Tags (Refer Pg. 222 for details)	CA509/K5WHT	100
Screw Driver	SCM0.5/3 Blade size: 0.5 x 3.0 mm	10

	Type / Cat. No.	Standard Pack
Terminal Block	CXG4/3	50
End Plate	EPCX4/3	50
Partition Plate	PPCX4/3	50
Mounting Rail (Refer Pg. 217 for details)	CA701-1M / CA701-1M-S	50 m
	CA701-15-1M / CA701-15-1M-S	25 m
End Clamp (Refer Pg. 218 for details)	CA103 / CA104	50
Warning Label	WLX4	100
Marking Tags (Refer Pg. 222 for details)	CA509/K6WHT	100
Screw Driver	SCM0.5/3 Blade size: 0.5 x 3.0 mm	10

	Type / Cat. No.	Standard Pack
Terminal Block	CXG4/3	50
End Plate	EPCX4/3	50
Partition Plate	PPCX4/3	50
Mounting Rail (Refer Pg. 217 for details)	CA701-1M / CA701-1M-S	50 m
	CA701-15-1M / CA701-15-1M-S	25 m
End Clamp (Refer Pg. 218 for details)	CA103 / CA104	50
Warning Label	WLX4	100
Marking Tags (Refer Pg. 222 for details)	CA509/K6WHT	100
Screw Driver	SCM0.5/3 Blade size: 0.5 x 3.0 mm	10

Jumpers	Type / Cat. No.	I _{max}	Standard Pack		
Pluggable Jumpers	2 pole	JX2.5/2	24 A	100	
	3 pole	JX2.5/3	24 A	50	
	4 pole	JX2.5/4	24 A	50	
	5 pole	JX2.5/5	24 A	50	
	6 pole	JX2.5/6	24 A	10	
	7 pole	JX2.5/7	24 A	10	
	8 pole	JX2.5/8	24 A	10	
	10 pole	JX2.5/10	24 A	10	
	Step Down Jumpers	4 - 2.5 mm ²	JXS4/2.5	24 A	50
		6 - 2.5 mm ²	JXS6/2.5	24 A	50
6 - 4 mm ²					
10 - 6 mm ²					
10 - 4 mm ²					
Test Plug	JXS10/2.5	24 A	50		
	TX2.5		20		

Jumpers	Type / Cat. No.	I _{max}	Standard Pack	
Pluggable Jumpers	2 pole	JX4/2	32 A	100
	3 pole	JX4/3	32 A	50
	4 pole	JX4/4	32 A	50
	6 pole	JX4/6	32 A	10
	8 pole	JX4/8	32 A	10
	10 pole	JX4/10	32 A	10
	4 - 2.5 mm ²	JXS4/2.5	24 A	50
	6 - 2.5 mm ²	JXS6/2.5	24 A	50
	6 - 4 mm ²	JXS6/4	32 A	50
	10 - 4 mm ²	JXS10/4	32 A	50
Test Plug	TX2.5		20	

Jumpers	Type / Cat. No.	I _{max}	Standard Pack	
Pluggable Jumpers	2 pole	JX4/2	32 A	100
	3 pole	JX4/3	32 A	50
	4 pole	JX4/4	32 A	50
	6 pole	JX4/6	32 A	10
	8 pole	JX4/8	32 A	10
	10 pole	JX4/10	32 A	10
	4 - 2.5 mm ²	JXS4/2.5	24 A	50
	6 - 2.5 mm ²	JXS6/2.5	24 A	50
	6 - 4 mm ²	JXS6/4	32 A	50
	10 - 4 mm ²	JXS10/4	32 A	50
Test Plug	TX2.5		20	

CXG4/4

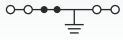

6 x 86.2 mm
38 mm / 45.5 mm

IEC	UL - CSA
0.2 - 4.0 mm ²	24 - 10 AWG
0.2 - 6.0 mm ²	24 - 10 AWG
0.2 - 4.0 mm ²	24 - 10 AWG
0.2 - 1.0 mm ²	24 - 18 AWG

10 mm



Polyamide 6,6 / 1
8 KV / 3

Type / Cat. No.	Standard Pack
CXG4/4	50
EPCX4/4	50
PPCX4/4	50
CA701-1M / CA701-1M-S	50 m
CA701-15-1M / CA701-15-1M-S	25 m
CA103 / CA104	50
WLX4	100
CA509/K6WHT	100
SCM0,5/3 Blade size: 0.5 x 3.0 mm	10

Type / Cat. No.	I _{max}	Standard Pack
JX4/2	32 A	100
JX4/3	32 A	50
JX4/4	32 A	50
JX4/8	32 A	10
JX4/10	32 A	10
JXS4/2.5	24 A	50
JXS6/4	32 A	50
JXS10/4	32 A	50

CXG6/3

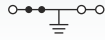

8 x 82.2 mm
43 mm / 50.5 mm

IEC	UL - CSA
0.2 - 6.0 mm ²	24 - 8 AWG
0.2 - 6.0 mm ²	24 - 8 AWG
0.2 - 1.5 mm ²	24 - 16 AWG

14 mm



Polyamide 6,6 / 1
8 KV / 3

Type / Cat. No.	Standard Pack
CXG6/3	50
EPCX6/3	50
CA701-1M / CA701-1M-S	50 m
CA701-15-1M / CA701-15-1M-S	25 m
CA103 / CA104	50
WLX6	100
CA509/K8WHT	100
SCM0,8/4 Blade size: 0.8 x 4 mm	10

Type / Cat. No.	I _{max}	Standard Pack
JX6/2	41 A	100
JX6/3	41 A	50
JX6/4	41 A	50
JX6/10	41 A	10
JXS6/2.5	34 A	50
JXS6/4	32 A	50
JXS10/6	41 A	50

CXG10/3

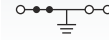

10 x 97 mm
49.3 mm / 56.8 mm

IEC	UL - CSA
0.2 - 10.0 mm ²	24 - 6 AWG
0.2 - 10.0 mm ²	24 - 6 AWG
1.5 - 4.0 mm ²	

18 mm



Polyamide 6,6 / 1
8 KV / 3

Type / Cat. No.	Standard Pack
CXG10/3	50
EPCX10/3	20
CA701-1M / CA701-1M-S	50 m
CA701-15-1M / CA701-15-1M-S	25 m
CA103 / CA104	50
WLX10	100
CA509/K10WHT	100
SCM0,8/4 Blade size: 0.8 x 4 mm	10

Type / Cat. No.	I _{max}	Standard Pack
JX10/2	57 A	20
JXS10/6	41 A	50
JXS10/4	32 A	50
JXS10/2.5	24 A	50

MULTIPLE LEVEL TERMINAL BLOCKS

CXDL2.5 is a compact double level Spring Clamp Terminal Block. This Terminal Block is used in high density wiring applications. Interconnections / shorting is possible at both levels. This Terminal Block is suitable for 1000 V rating.

CXDL2.5(I.S) is double level internally shorted Terminal Block. This is an ideal choice for distribution application.

CXDLG2.5 is double level spring clamp Terminal Block with an additional grounding point for terminating grounding cables on the lower level of the terminal block. The earth connection is made by snapping the terminal on the Din rail. This separate connection point is appropriately identified by the green-yellow imprint on its top.

CXDLG2.5(I.S) is double level ground Terminal Block with 4 connection points for grounding wires. It is available in a standard green-yellow colour to indicate the grounding connection.

Width (Thickness) x Length		5 x 72.7 mm			
Height with DIN 35 x 7.5 / 35 x 15 mm Rail		49.5 mm / 57 mm			
Connection Possibility as per		IEC		UL - CSA	
With 1 Conductor per clamp	Stranded / Flexible	0.2 - 2.5 mm ²		24 - 12 AWG	
	Solid	0.2 - 4.0 mm ²		24 - 10 AWG	
	with Ferrule / Lug	0.2 - 2.5 mm ²		24 - 12 AWG	
With 2 same size Conductors per clamp	with TWIN Ferrule / Lug	0.2 - 1.0 mm ²		24 - 20 AWG	
Wire Stripping Length		10 mm			
Ratings As Per		IEC60947-7-1	UL-1059	CSA22.2-158	IEC60079-7
Voltage		1000 V	600 V	600 V	630 V
Current		24 A	20 A	20 A	21 A
Approval					
Insulation Material / Material Group		Polyamide 6,6 / 1			
Rated Impulse Voltage / Pollution Degree		8 KV / 3			

CXDL2.5



		Type / Cat. No.	Standard Pack
Terminal Block	Grey	CXDL2.5	50
	Blue	CXDL2.5BU	50
	Red	CXDL2.5R	50
	Yellow	CXDL2.5Y	50
	Black	CXDL2.5BK	50
	Green	CXDL2.5GN	50
	Orange	CXDL2.5O	50
	Ground / Earth	CXDLG2.5(I.S.)	50
End Plate		EPCXDL2.5	50
Mounting Rail (Refer Pg. 217 for details)		CA701-1M / CA701-1M-S	50 m
		CA701-15-1M / CA701-15-1M-S	25 m
End Clamp (Refer Pg. 218 for details)		CA103 / CA104	50
Warning Label		WLX2.5	100
Marking Tags (Refer Pg. 222 for details)		CA509/K5WHT	100
Screw Driver		SCM0.5/3 Blade size: 0.5 x 3.0 mm	10
Dual Marker Carrier		TM5	50

Jumpers		Type / Cat. No.	I _{max}	Standard Pack	
Pluggable Jumpers	2 pole	JX2.5/2	24 A	100	
	3 pole	JX2.5/3	24 A	50	
	4 pole	JX2.5/4	24 A	50	
	5 pole	JX2.5/5	24 A	50	
	6 pole	JX2.5/6	24 A	10	
	7 pole	JX2.5/7	24 A	10	
	8 pole	JX2.5/8	24 A	10	
	10 pole	JX2.5/10	24 A	10	
	Test Plug		TX2.5		20

CXDL2.5(I.S)

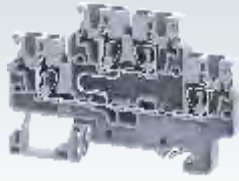

5 x 72.7 mm
49.5 mm / 57 mm

IEC	UL - CSA
0.2 - 2.5 mm ²	24 - 12 AWG
0.2 - 4.0 mm ²	24 - 10 AWG
0.2 - 2.5 mm ²	24 - 12 AWG

0.2 - 1.0 mm² 24 - 20 AWG

10 mm

IEC60947-7-1 UL-1059 CSA22.2-158 IEC60079-7

1000 V	600 V	600 V	630 V
24 A	20 A	20 A	21 A



Polyamide 6,6 / 1

8 KV / 3

Type / Cat. No.	Standard Pack
CXDL2.5(I.S)	50
EPCXDL2.5	50
CA701-1M / CA701-1M-S	50 m
CA701-15-1M / CA701-15-1M-S	25 m
CA103 / CA104	50
WLX2.5	100
CA509/K5WHT	100
SCM0.5/3 Blade size: 0.5 x 3.0 mm	10
TM5	50

Type / Cat. No.	I _{max}	Standard Pack
JX2.5/2	24 A	100
JX2.5/3	24 A	50
JX2.5/4	24 A	50
JX2.5/5	24 A	50
JX2.5/6	24 A	10
JX2.5/7	24 A	10
JX2.5/8	24 A	10
JX2.5/10	24 A	10
TX2.5		20

CXDLG2.5

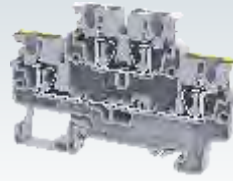

5 x 72.7 mm
49.5 mm / 57 mm

IEC	UL - CSA
0.2 - 2.5 mm ²	24 - 12 AWG
0.2 - 4.0 mm ²	24 - 10 AWG
0.2 - 2.5 mm ²	24 - 12 AWG

0.2 - 1.0 mm² 24 - 20 AWG

10 mm

IEC60947-7-1 UL-1059 CSA22.2-158 IEC60079-7

1000 V	600 V	600 V	630 V
24 A	20 A		21 A



Polyamide 6,6 / 1

8 KV / 3

Type / Cat. No.	Standard Pack
CXDLG2.5	50
EPCXDL2.5	50
CA701-1M / CA701-1M-S	50 m
CA701-15-1M / CA701-15-1M-S	25 m
CA103 / CA104	50
WLX2.5	100
CA509/K5WHT	100
SCM0.5/3 Blade size: 0.5 x 3.0 mm	10
TM5	50

Type / Cat. No.	I _{max}	Standard Pack
JX2.5/2	24 A	100
JX2.5/3	24 A	50
JX2.5/4	24 A	50
JX2.5/5	24 A	50
JX2.5/6	24 A	10
JX2.5/7	24 A	10
JX2.5/8	24 A	10
JX2.5/10	24 A	10
TX2.5		20

CXDLG2.5(I.S)

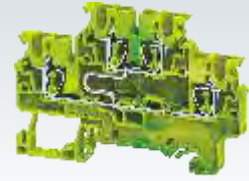

5 x 72.7 mm
49.5 mm / 57 mm

IEC	UL - CSA
0.2 - 2.5 mm ²	24 - 12 AWG
0.2 - 4.0 mm ²	24 - 10 AWG
0.2 - 2.5 mm ²	24 - 12 AWG

0.2 - 1.0 mm² 24 - 20 AWG

10 mm

IEC60947-7-1 UL-1059 CSA22.2-158 IEC60079-7

1000 V	600 V	600 V	630 V



Polyamide 6,6 / 1

8 KV / 3

Type / Cat. No.	Standard Pack
CXDLG2.5(I.S)	50
EPCXDL2.5	50
CA701-1M / CA701-1M-S	50 m
CA701-15-1M / CA701-15-1M-S	25 m
CA103 / CA104	50
WLX2.5	100
CA509/K5WHT	100
SCM0.5/3 Blade size: 0.5 x 3.0 mm	10
TM5	50

Type / Cat. No.	I _{max}	Standard Pack
JX2.5/2	24 A	100
JX2.5/3	24 A	50
JX2.5/4	24 A	50
JX2.5/5	24 A	50
JX2.5/6	24 A	10
JX2.5/7	24 A	10
JX2.5/8	24 A	10
JX2.5/10	24 A	10
TX2.5		20

MULTIPLE LEVEL TERMINAL BLOCKS

ADLG2.5 & ATLG2.5 Terminal Blocks have an additional grounding point for terminating earthing / grounding cables. The earth connection is made by snapping the terminal on the DIN rail. This separate connection point is appropriately identified by the green-yellow imprint on its top.

ATL series Triple Terminal Blocks are an ideal choice for control systems where sensor and actuator applications are involved. The simplified 3-level connections tremendously increase wiring density in the circuit.

ADLG2.5



Width (Thickness) x Length	5 x 83.7 mm		
Height with DIN 35 x 7.5 / 35 x 15 mm Rail	64.8 mm / 72.3 mm		
Connection Possibility as per	IEC	UL - CSA	
With 1 Conductor per clamp	Stranded / Flexible	0.2 - 2.5 mm ²	22 - 12 AWG
	Solid	0.2 - 4.0 mm ²	22 - 10 AWG
	with Ferrule / Lug	0.2 - 2.5 mm ²	22 - 12 AWG
With 2 same size Conductors per clamp	with TWIN Ferrule / Lug	0.2 - 1.5 mm ²	22 - 14 AWG
Wire Stripping Length	10 mm		
Ratings As Per	IEC60947-2 UL-1059		
Voltage	500 V	600 V	
Current	24 A	20 A	
Approvals			
Insulation Material / Comparative Tracking Index	Polyamide 66 / 1		
Rated Impulse Voltage / Pollution Degree	6 KV / 3		

	Type / Cat. No.	Standard Pack
Terminal Block	ADLG2.5	50
End Plate	EPADLG2.5	50
Mounting Rail (Refer Pg. 217 for details)	CA701-1M / CA701-1M-S	50 m
	CA701-15-1M / CA701-15-1M-S	25 m
End Clamp (Refer Pg. 218 for details)	CA702 / CA802 / CA202 / CA103	50
Marking Tags (Refer Pg. 222 for details)	CA509/K2GWHT	100
Screw Driver	SCM0.5/3 Blade size: 0.5 x 3 mm	10

	Type / Cat. No.	I _{max}	Standard Pack
Pluggable Jumpers	2 pole	24 A	100
	3 pole	24 A	100
	4 pole	24 A	100
	10 pole	24 A	10

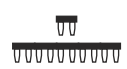

ATL2.5



5 x 100 mm

75 mm / 82.5 mm

IEC	UL - CSA
0.2 - 2.5 mm ²	22 - 12 AWG
0.2 - 4.0 mm ²	22 - 10 AWG
0.2 - 2.5 mm ²	22 - 12 AWG

0.2 - 1.5 mm² 22 - 14 AWG

10 mm

IEC60947-7-1 UL-1059

500 V	600 V		
24 A	20 A		



Polyamide 6,6 / 1

6 KV / 3

ATL2.5H

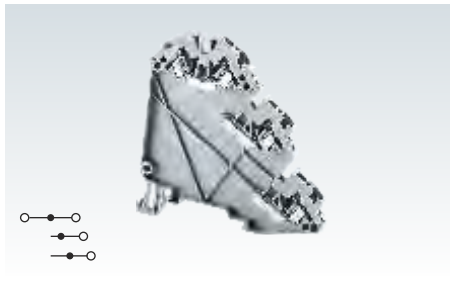

5 x 76.1 mm

75 mm / 82.5 mm

IEC	UL - CSA
0.2 - 2.5 mm ²	22 - 12 AWG
0.2 - 4.0 mm ²	22 - 10 AWG
0.2 - 2.5 mm ²	22 - 12 AWG

0.2 - 1.5 mm² 22 - 14 AWG

10 mm

IEC60947-7-1

500 V			
24 A			



Polyamide 6,6 / 1

6 KV / 3

ATLG2.5

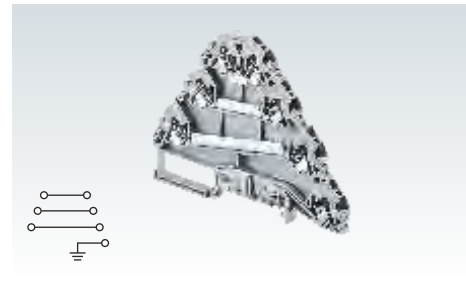

5 x 100 mm

75 mm / 82.5 mm

IEC	UL - CSA
0.2 - 2.5 mm ²	22 - 12 AWG
0.2 - 4.0 mm ²	22 - 10 AWG
0.2 - 2.5 mm ²	22 - 12 AWG

0.2 - 1.5 mm² 22 - 14 AWG

10 mm

IEC60947-7-2 UL-1059

500 V	600 V		
24 A	20 A		



Polyamide 6,6 / 1

6 KV / 3

Type / Cat. No.	Standard Pack
ATL2.5	50
EPATL2.5	50
CA701-1M / CA701-1M-S	50 m
CA701-15-1M / CA701-15-1M-S	25 m
CA702 / CA802 / CA202 / CA103	50
CA509/K2GWHT	100
SCM0.5/3 Blade size: 0.5 x 3.0 mm	10

Type / Cat. No.	Standard Pack
ATL2.5H	25
EPATL2.5H	50
CA701-1M / CA701-1M-S	50 m
CA701-15-1M / CA701-15-1M-S	25 m
CA702 / CA802 / CA202 / CA103	50
CA509/K2GWHT	100
SCM0.5/3 Blade size: 0.5 x 3.0 mm	10

Type / Cat. No.	Standard Pack
ATLG2.5	50
EPATLG2.5	50
CA701-1M / CA701-1M-S	50 m
CA701-15-1M / CA701-15-1M-S	25 m
CA702 / CA802 / CA202 / CA103	50
CA509/K2GWHT	100
SCM0.5/3 Blade size: 0.5 x 3.0 mm	10

Type / Cat. No.	I _{max}	Standard Pack
CA801/A2	24 A	100
CA801/A3	24 A	100
CA801/A4	24 A	100
CA801/A10	24 A	10

Type / Cat. No.	I _{max}	Standard Pack
CA801/A2	24 A	100
CA801/A3	24 A	100
CA801/A4	24 A	100
CA801/A10	24 A	10

Type / Cat. No.	I _{max}	Standard Pack

TERMINAL BLOCKS WITH ELECTRONIC COMPONENTS

These are electronic series spring clamp double level Terminal Blocks with built in diodes and LED.

The built in diode acts as a free wheeling diode which is connected across the inductive load such as relay coils, solenoid valves, contactor coils to eliminate or suppress sudden voltage spike which appears across the load when its supply voltage is removed.

CXDL2.5(E)LD1 Terminal Block has a built in LED circuit for online indication.

CX2.5/4(E)D1 is specially designed 4 wire spring clamp Terminal Block with a built in diode. This Terminal has a built in 1N4007 diode for reverse polarity protection and also allows uni directional flow of current.

Width (Thickness) x Length	5 x 72.7 mm		
Height with DIN 35 x 7.5 / 35 x 15 mm Rail	49.5 mm / 57 mm		
Connection Possibility as per	IEC	UL - CSA	
With 1 Conductor per clamp	Stranded / Flexible	0.2 - 2.5 mm ²	24 - 12 AWG
	Solid	0.2 - 4.0 mm ²	24 - 10 AWG
	with Ferrule / Lug	0.2 - 2.5 mm ²	24 - 12 AWG
With 2 same size Conductors per clamp	with TWIN Ferrule / Lug	0.2 - 1.0 mm ²	24 - 18 AWG
Wire Stripping Length	10 mm		
Ratings As Per	IEC60947-7-1	UL-1059	CSA22.2-158
Voltage	1000 V	600 V	600 V
Current	1 A	1 A	
Approval			
Insulation Material / Comparative Tracking Index	Polyamide 66 / 1		
Rated Impulse Voltage / Pollution Degree	8 KV / 3		

	Type / Cat. No.	Standard Pack
End Plate	EPCXDL2.5	50
Mounting Rail (Refer Pg. 217 for details)	CA701-1M / CA701-1M-S	50 m
	CA701-15-1M / CA701-15-1M-S	25 m
End Clamp (Refer Pg. 218 for details)	CA103 / CA104	50
Warning Label	WLX2.5	100
Marking Tags (Refer Pg. 222 for details)	CA509/K5WHT	100
Screw Driver	SCM0.5/3 Blade size: 0.5 x 3.0 mm	10
Dual Marker Carrier	TM5	50

Jumpers	Type / Cat. No.	I _{max}	Standard Pack	
Pluggable Jumpers	2 pole	JX2.5/2	24 A	100
	3 pole	JX2.5/3	24 A	50
	4 pole	JX2.5/4	24 A	50
	5 pole	JX2.5/5	24 A	50
	6 pole	JX2.5/6	24 A	10
	7 pole	JX2.5/7	24 A	10
	8 pole	JX2.5/8	24 A	10
	10 pole	JX2.5/10	24 A	10
Test Plug	TX2.5		20	

Part No.	Application	Std. Pack
CXDL2.5(E)D1	Arc suppression circuit for contactors & solenoid valves - D.C	50

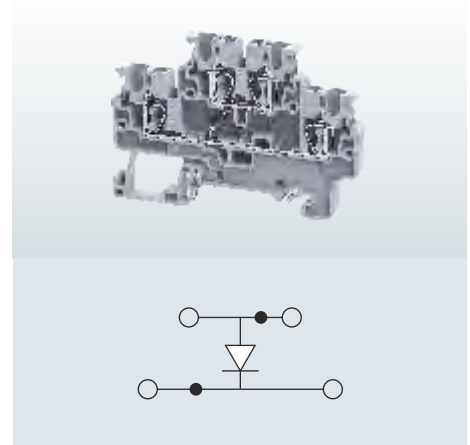

Part No.	Application	Std. Pack
CXDL2.5(E)D2	Arc suppression circuit for contactors & solenoid valves - D.C	50

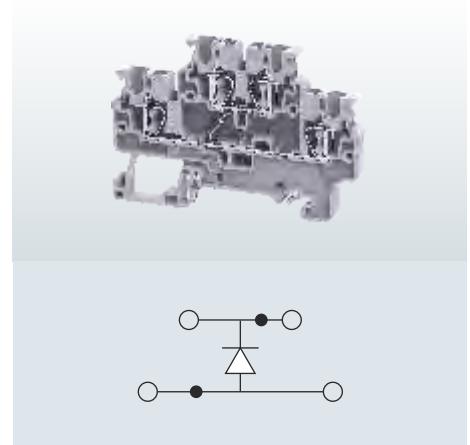

Part No.	Application	Std. Pack
CXDL2.5(E)D3	Diode circuit for reverse polarity protection	50

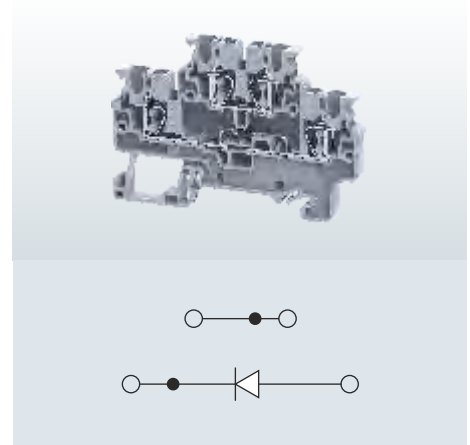

Part No.	Application	Std. Pack
CXDL2.5(E)DD1	Diode circuit for lamp testing	50

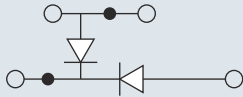

Part No.	Application	Std. Pack
CXDL2.5(E)DD2	Diode circuit for lamp testing	50

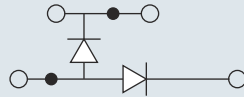

Part No.	Application	Std. Pack
CXDL2.5(E)DD3	Diode circuit for lamp testing	50

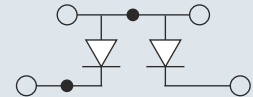

Part No.	Application	Std. Pack
CXDL2.5(E)DD4	Diode circuit for lamp testing	50

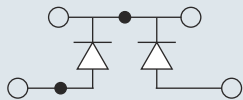
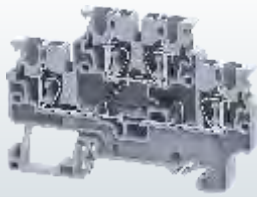

Part No.	Application	Std. Pack
CXDL2.5(E)LD1	DC Voltage indicator with LED	50

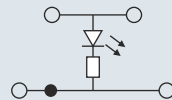
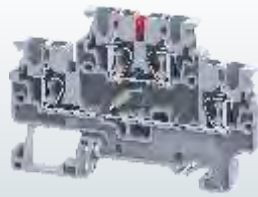

Part No.	Application	Std. Pack
CXDL2.5(E)TS1	Temperature sensor for measuring temperature	50

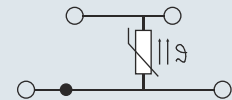

Part No.	Application	Std. Pack
CX2.5/4(E)D1	Arc suppression circuit for contactors & solenoid valves - D.C	100
CX2.5/4(E)D2		100

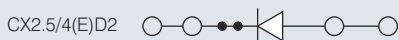
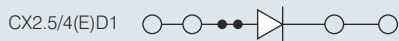
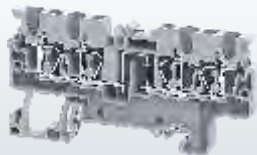

Width (Thickness) x Length	5 x 74.7 mm	
Height with DIN 35 x 7.5 / 35 x 15 mm Rail	38 mm / 45.7 mm	
End Plate	EPCX2.5/4	20
Partition Plate	PPCX4/4	20

FUSE TERMINAL BLOCKS

These Terminal Blocks are used in electrical and control systems which require fuse protection. These Terminal Blocks accept industry standard Ø 5 x 20 mm cartridge fuses. Fuse blocks with suffix (L) are used for off-line indication in case of fuse blow out.

CXF4 & CXVF series terminals have a built in end plate and hence no live parts are exposed. They can be internally bridged using standard shorting accessories.

CXVF Terminal Blocks have an integral fuse carrier which can be screwed into the base terminal. CXVF2.5 series terminals have 2 independent 2.5 mm² wire connection clamping points on the output side.

CXFVA series accepts Ø5 X 20 mm fuses.

CXFVB series accepts Ø5 X 25 mm fuses.

CXFVC series accepts Ø¼" X 1" and Ø¼" X 1¼" (Ø6.3 X 32 mm) fuses.

Fuse Blocks with suffix L are used for off-line indication in case of fuse blow out.

CXF4/3 & CXAF4/3 are multi connect 3 wire fuse Terminal Block for Ø 5 x 20 mm cartridge fuses and automotive fuses respectively. Automotive fuses are a class of fuses used to protect the wiring and electrical equipments for vehicles.

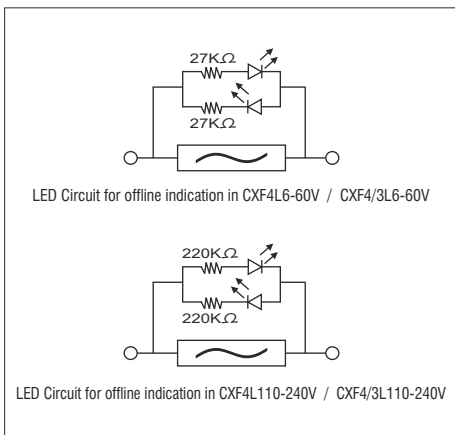

CXF4



Width (Thickness) x Length		6 x 65.4 mm			
Height with DIN 35 x 7.5 / 35 x 15 mm Rail		69.1 mm / 76.6 mm			
Connection Possibility as per		IEC			
With 1 Conductor per clamp	Stranded / Flexible	0.2 - 4.0 mm ²		UL - CSA	
	Solid	0.2 - 6.0 mm ²		24 - 10 AWG	
	with Ferrule / Lug	0.2 - 4.0 mm ²		24 - 10 AWG	
With 2 same size Conductors per clamp	with TWIN Ferrule / Lug	0.2 - 1.5 mm ²		24 - 14 AWG	
Wire Stripping Length		10 mm			
Ratings As Per		IEC60947-3 UL-1059 CSA22.2-158 IEC60079-7			
Voltage		1000 V	600 V	600 V	630 V
Current		10A	10A	10 A	6.3 A
Approval					
Insulation Material / Material Group		Polyamide 6,6 / 1			
Rated Impulse Voltage / Pollution Degree		4 KV / 3			

		Type / Cat. No.	Standard Pack
Terminal Block for Ø5 x 20 mm Fuse	Grey	CXF4	50
	With LED for 6-60 V AC/DC	CXF4L6-60V	50
	With LED for 110-240 V AC/DC	CXF4L110-240V	50
Terminal Block for Automotive Fuse	Grey		
	With LED for 12 V AC/DC		
	With LED for 24 V AC/DC		
Terminal Block for Ø5 x 20 mm Fuse	Grey		
	With LED for 12 V AC/DC		
	With LED for 24 V AC/DC		
	With LED for 48 V AC/DC		
	With LED for 60 V AC/DC		
Terminal Block for Ø5 x 25 mm Fuse	Grey		
	With LED for 12 V AC/DC		
	With LED for 24 V AC/DC		
	With LED for 48 V AC/DC		
	With LED for 60 V AC/DC		
Terminal Block for Ø¼" x 1", Ø¼" x 1¼" (6.3 x 32 mm) Fuse	Grey		
	With LED for 12 V AC/DC		
	With LED for 24 V AC/DC		
	With LED for 48 V AC/DC		
	With LED for 60 V AC/DC		
End Plate			
Partition Plate		PPCX4/3	50
Mounting Rail (Refer Pg. 217 for details)		CA701-1M / CA701-1M-S	50 m
		CA701-15-1M / CA701-15-1M-S	25 m
End Clamp (Refer Pg. 218 for details)		CA103 / CA104	50
Warning Label		WLX4	100
Marking Tags (Refer Pg. 222 for details)		CA509/K6WHT	100
Screw Driver		SCM0.5/3 Blade size: 0.5 x 3 mm	10

Jumpers		Type / Cat. No.	I _{max}	Standard Pack
Pluggable Jumpers	2 pole	JX4/2	32 A	100
	3 pole	JX4/3	32 A	50
	4 pole	JX4/4	32 A	50
	8 pole	JX4/8	32 A	10
	10 pole	JX4/10	32 A	10

CXVF / CXVF2.5



12 X 75 mm
43 mm / 50.5 mm

Wire Range	CXVF	CXVF2.5
I/P Wire IEC	0.2 - 6.0 mm ²	0.2 - 6.0 mm ²
O/P Wire IEC	0.2 - 6.0 mm ²	0.2 - 2.5 mm ²
I/P Wire UL	24 - 8 AWG	24 - 8 AWG
O/P Wire UL	24 - 8 AWG	24 - 12 AWG

10 mm

IEC60947-7-3 UL-1059 CSA22.2-158

800 V	600 V	600 V
10A	10A	10A



Polyamide 6,6 / 1

8 KV / 3

Type / Cat. No. (with 1 in 1 out Connection)	Type / Cat. No. (with 1 in 2 out Connection)	Std. Pack
---	---	-----------

CXVFA	CXVF2.5A	50
CXVFAL12V	CXVF2.5AL12V	50
CXVFAL24V	CXVF2.5AL24V	50
CXVFAL48V	CXVF2.5AL48V	50
CXVFAL60V	CXVF2.5AL60V	50
CXVFAL240V	CXVF2.5AL240V	50
CXVFB	CXVF2.5B	50
CXVFBL12V	CXVF2.5BL12V	50
CXVFBL24V	CXVF2.5BL24V	50
CXVFBL48V	CXVF2.5BL48V	50
CXVFBL60V	CXVF2.5BL60V	50
CXVFBL240V	CXVF2.5BL240V	50
CXVFC	CXVF2.5C	50
CXVFCL12V	CXVF2.5CL12V	50
CXVFCL24V	CXVF2.5CL24V	50
CXVFCL48V	CXVF2.5CL48V	50
CXVFCL60V	CXVF2.5CL60V	50
CXVFCL240V	CXVF2.5CL240V	50

CA701-1M / CA701-1M-S	50 m
CA701-15-1M / CA701-15-1M-S	25 m

CA103 / CA104 50

CA509/K12WHT 100

SCM0.8/4 Blade size: 0.8 x 4 mm 10

Type / Cat. No.	I _{max}	Standard Pack
JX4/4	32 A	50
JX4/8	32 A	10
JX4/10	32 A	10

CXF4/3

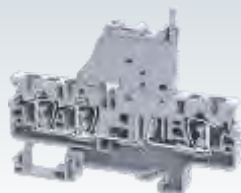

6 x 86.2 mm
69.1 mm / 76.6 mm

IEC	UL - CSA
0.2 - 4.0 mm ²	24 - 10 AWG
0.2 - 6.0 mm ²	
0.2 - 4.0 mm ²	24 - 10 AWG
0.2 - 1.5 mm ²	24 - 14 AWG

10 mm

IEC60947-7-3 UL-1059

1000 V	600 V
10A	10A



Polyamide 6,6 / 1

4 KV / 3

Type / Cat. No.	Standard Pack
-----------------	---------------

CXF4/3	50
CXF4/3L6-60V	50
CXF4/3L110-240V	50

EPCX4/4	50
---------	----

PPCX4/4 50

CA701-1M / CA701-1M-S	50 m
CA701-15-1M / CA701-15-1M-S	25 m

CA103 / CA104 50

WLX4 100

CA509/K6WHT 100

SCM0.5/3 Blade size: 0.5 x 3 mm 10

Type / Cat. No.	I _{max}	Standard Pack
JX4/2	32 A	100
JX4/3	32 A	50
JX4/4	32 A	50
JX4/8	32 A	10
JX4/10	32 A	10

CXAF4/3



6 x 86.2 mm
43.2 mm / 50.7 mm

IEC	UL - CSA
0.2 - 4.0 mm ²	24 - 10 AWG
0.2 - 6.0 mm ²	
0.2 - 4.0 mm ²	24 - 10 AWG
0.2 - 1.5 mm ²	24 - 14 AWG

10 mm

IEC60947-7-3 UL-1059 CSA22.2-158 IEC60079-7

1000 V	600 V	600 V	630 V
10A	10A	10A	6.3 A



Polyamide 6,6 / 1

4 KV / 3

Type / Cat. No.	Standard Pack
-----------------	---------------

CXAF4/3	50
CXAF4/3L12V	50
CXAF4/3L24V	50

EPCX4/4	50
---------	----

PPCX4/4 50

CA701-1M / CA701-1M-S	50 m
CA701-15-1M / CA701-15-1M-S	25 m

CA103 / CA104 50

WLX4 100

CA509/K6WHT 100

SCM0.5/3 Blade size: 0.5 x 3 mm 10

Type / Cat. No.	I _{max}	Standard Pack
JX4/2	32 A	100
JX4/3	32 A	50
JX4/4	32 A	50
JX4/8	32 A	10
JX4/10	32 A	10

DISCONNECT & TEST TERMINAL BLOCKS

CXK series terminals are compact disconnect spring clamp Terminal Blocks.

In these Terminal Blocks disconnection is achieved by opening the insulated knife (blade) contact in the middle of the terminal.

Separate testing points are provided on top for inserting standard Ø2.3 mm test probes.

Alternate and continuous bridging can be done with standard pluggable jumpers.

Multi connect 3 & 4 wire terminals eliminate reliability problems encountered when there is a need to connect multiple wires in a single Terminal Block.

CXK2.5

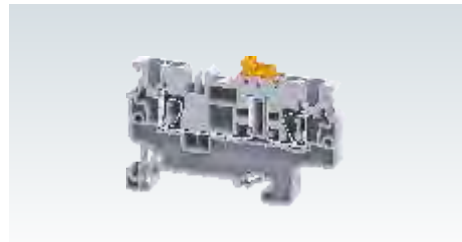

Width (Thickness) x Length	5 x 62.2 mm			
Height with DIN 35 x 7.5 / 35 x 15 mm Rail	42.3 mm / 49.8 mm			
Connection Possibility as per	IEC		UL - CSA	
With 1 Conductor per clamp	Stranded / Flexible	0.2 - 2.5 mm ²	24 - 12 AWG	
		0.2 - 4.0 mm ²	24 - 10 AWG	
	Solid with Ferrule / Lug	0.2 - 2.5 mm ²	24 - 12 AWG	
With 2 same size Conductors per clamp	with TWIN Ferrule / Lug	0.2 - 0.5 mm ²	24 - 20 AWG	
Wire Stripping Length	10 mm			
Ratings As Per	IEC60947-7-1	UL-1059	CSA22.2-158	IEC60079-7
Voltage	1000 V	600 V	600 V	630 V
Current	20 A	16 A	16 A	17 A
Approval				
Insulation Material / Material Group	Polyamide 6,6 / 1			
Rated Impulse Voltage / Pollution Degree	6 KV / 3			

		Type / Cat. No.	Standard Pack	
Terminal Block	Grey	CXK2.5	100	
	Blue	CXK2.5BU	100	
End Plate		EPCX2.5/3	50	
Partition Plate		PPCX4/3	50	
Mounting Rail (Refer Pg. 217 for details)		CA701-1M / CA701-1M-S	50 m	
		CA701-15-1M / CA701-15-1M-S	25 m	
End Clamp (Refer Pg. 218 for details)		CA103 / CA104	50	
Warning Label		WLX2.5	100	
Marking Tags (Refer Pg. 222 for details)		CA509/K5WHT	100	
Disconnecting Marker		CA509/K4WHT	100	
Screw Driver		SCM0.5/3 Blade size: 0.5 x 3 mm	10	
Jumpers		Type / Cat. No.	Imax	Standard Pack
Pluggable Jumpers		JX2.5/2	24 A	100
		JX2.5/3	24 A	50
		JX2.5/4	24 A	50
		JX2.5/5	24 A	50
		JX2.5/6	24 A	10
		JX2.5/7	24 A	10
		JX2.5/8	24 A	10
		JX2.5/9	24 A	10
		JX2.5/10	24 A	10
	Test Plug		TX2.5	

CXK2.5/4



5 x 74.7 mm
42.3 mm / 49.8 mm

IEC	UL - CSA
0.2 - 2.5 mm ²	24 - 12 AWG
0.2 - 4.0 mm ²	24 - 10 AWG
0.2 - 2.5 mm ²	24 - 12 AWG
0.2 - 0.5 mm ²	24 - 20 AWG

10 mm

IEC60947-7-1 UL-1059 IEC60079-7

1000 V	600 V	630 V
20 A	16 A	17 A



Polyamide 6,6 / 1
6 KV / 3

CXK4



6 x 65.7 mm
42.6 mm / 50.1 mm

IEC	UL - CSA
0.2 - 4.0 mm ²	24 - 10 AWG
0.2 - 6.0 mm ²	
0.2 - 4.0 mm ²	24 - 10 AWG
0.2 - 1.0 mm ²	24 - 18 AWG

10 mm

IEC60947-7-1 UL-1059

1000 V	300 V
22 A	22 A



Polyamide 6,6 / 1
8 KV / 3

CXK4/3



6 x 86.2 mm
42.6 mm / 50.1 mm

IEC	UL - CSA
0.2 - 4.0 mm ²	24 - 10 AWG
0.2 - 6.0 mm ²	
0.2 - 4.0 mm ²	24 - 10 AWG
0.2 - 1.0 mm ²	24 - 18 AWG

10 mm

IEC60947-7-1 UL-1059

1000 V	600 V
22 A	30 A



Polyamide 6,6 / 1
8 KV / 3

Type / Cat. No.	Standard Pack
CXK2.5/4	50
CXK2.5/4BU	50
EPCX2.5/4	50
PPCX4/4	50
CA701-1M / CA701-1M-S	50 m
CA701-15-1M / CA701-15-1M-S	25 m
CA103 / CA104	50
WLX2.5	100
CA509/K5WHT	100
CA509/K4WHT	100
SCM0.5/3 Blade size: 0.5 x 3 mm	10

Type / Cat. No.	I _{max}	Standard Pack
JX2.5/2	24 A	100
JX2.5/3	24 A	50
JX2.5/4	24 A	50
JX2.5/5	24 A	50
JX2.5/6	24 A	10
JX2.5/7	24 A	10
JX2.5/8	24 A	10
JX2.5/10	24 A	10
TX2.5		20

Type / Cat. No.	Standard Pack
CXK4	100
CXK4BU	100
PPCX4/4	50
CA701-1M / CA701-1M-S	50 m
CA701-15-1M / CA701-15-1M-S	25 m
CA103 / CA104	50
WLX4	50
CA509/K6WHT	100
CA509/K5WHT	100
SCM0.5/3 Blade size: 0.5 x 3 mm	10

Type / Cat. No.	I _{max}	Standard Pack
JX4/2	32 A	100
JX4/3	32 A	50
JX4/4	32 A	50
JX4/8	32 A	10
JX4/10	32 A	10

Type / Cat. No.	Standard Pack
CXK4/3	50
CXK4/3BU	50
EPCX4/4	50
PPCX4/4	50
CA701-1M / CA701-1M-S	50 m
CA701-15-1M / CA701-15-1M-S	25 m
CA103 / CA104	50
WLX4	50
CA509/K6WHT	100
CA509/K5WHT	100
SCM0.5/3 Blade size: 0.5 x 3 mm	10

Type / Cat. No.	I _{max}	Standard Pack
JX4/2	32 A	100
JX4/3	32 A	50
JX4/4	32 A	50
JX4/8	32 A	10
JX4/10	32 A	10

MICRO SPRING CLAMP TERMINAL BLOCKS

These Terminal Blocks are an excellent solution for extremely compact wiring applications. The Terminal Blocks DIN 15 type (DIN 2) rails.

CXM series terminals have standard top wire entry and cross connection can be achieved by using pluggable jumpers.

CMS2.5 series terminal has a side wire entry configuration.

Width (Thickness) x Length	5 x 37 mm		
Height with DIN 15 mm Rail	35 mm		
Connection Possibility as per	IEC	UL - CSA	
With 1 Conductor per clamp	Stranded / Flexible	0.2 - 2.5 mm ²	24 - 12 AWG
	Solid	0.2 - 4.0 mm ²	24 - 10 AWG
	with Ferrule / Lug	0.2 - 2.5 mm ²	24 - 12 AWG
With 2 same size Conductors per clamp	with TWIN Ferrule / Lug	0.2 - 1.5 mm ²	24 - 16 AWG
Wire Stripping Length	10 mm		
Ratings As Per	IEC60947-7-1	UL-1059	
Voltage	1000 V	600 V	
Current	24 A	20 A	
Approval			
Insulation Material / Comparative Tracking Index	Polyamide 66 / 1		
Rated Impulse Voltage / Pollution Degree	8 KV / 3		



	Type / Cat. No.	I _{max}	Standard Pack
Terminal Block	Grey	CXM2.5	100
	Blue	CXM2.5BU	100
	Red	CXM2.5R	100
	Yellow	CXM2.5Y	100
	Black	CXM2.5BK	100
	Green	CXM2.5GN	100

End Plate	EPCXM2.5	50
Mounting Rail (Refer Pg. 217 for details)	CA601	50 m
End Clamp (Refer Pg. 218 for details)	CA602	50
Actuator for actuating the spring clamp	SCA2.5	1
Marking Tag (Refer Pg. 222 for details)	MS5WHT	100
Screw Driver		

	Type / Cat. No.	I _{max}	Standard Pack	
Pluggable Jumpers	2 pole	JX2.5/2	24 A 100	
	3 pole	JX2.5/3	24 A 50	
	4 pole	JX2.5/4	24 A 50	
	5 pole	JX2.5/5	24 A 50	
	6 pole	JX2.5/6	24 A 10	
	7 pole	JX2.5/7	24 A 10	
	8 pole	JX2.5/8	24 A 10	
	10 pole	JX2.5/10	24 A 10	
	Test Plug	TX2.5		20

CXMG2.5



For DIN 15 Rail Mounting

5 x 37 mm

35 mm

IEC	UL - CSA
0.2 - 2.5 mm ²	24 - 12 AWG
0.2 - 4.0 mm ²	24 - 10 AWG
0.2 - 2.5 mm ²	24 - 12 AWG

0.2 - 1.5 mm² 24 - 16 AWG

10 mm



Polyamide 66 / 1

8 KV / 3

Type / Cat. No.	Standard Pack
CXMG2.5	100
EPCXM2.5	50
CA601	50 m
CA602	50
SCA2.5	1
MS5WHT	100

Type / Cat. No.	I _{max}	Standard Pack
JX2.5/2	24 A	100
JX2.5/3	24 A	50
JX2.5/4	24 A	50
JX2.5/5	24 A	50
JX2.5/6	24 A	10
JX2.5/7	24 A	10
JX2.5/8	24 A	10
JX2.5/10	24 A	10
TX2.5		20

CMS2.5



For DIN 15 Rail Mounting

5 x 31mm

30.15 mm

IEC	UL - CSA
0.2 - 2.5 mm ²	24 - 12 AWG
0.2 - 4.0 mm ²	24 - 10 AWG
0.2 - 2.5 mm ²	24 - 12 AWG

0.2 - 0.5 mm² 24 - 20 AWG

9 mm

IEC60947-7-1 UL-1059 CSA22.2-158 IEC60079-7

800 V	300 V	300 V	400 V
24 A	20 A	20 A	21 A



Polyamide 6,6 / 1

6 KV / 3

Type / Cat. No.	Standard Pack
CMS2.5	100
CMS2.5BU	100
CMS2.5R	100
CMS2.5Y	100
CMS2.5BK	100
CMS2.5GN	100
EPCMS2.5	50
CA601	50 m
CA602	50
CA509/K5WHT	100
SCM0.5/3 Blade size: 0.5 x 3 mm	10

Type / Cat. No.	I _{max}	Standard Pack

SIDE ENTRY FEED THROUGH & GROUND / EARTH TERMINAL BLOCKS

CXS series Terminal Blocks, have a side wire entry configuration.

This Terminal Block can be actuated from side as well as from the top using standard screw driver.

It is specially designed for mounting location with low installation height.

Width (Thickness) x Length	5 x 45.9 mm			
Height with DIN 35 x 7.5 / 35 x 15 mm Rail	43.5 mm / 50.8 mm			
Connection Possibility as per	IEC		UL - CSA	
With 1 Conductor per clamp	Stranded / Flexible	0.2 - 2.5 mm ²	24 - 12 AWG	
	Solid	0.2 - 4.0 mm ²	24 - 10 AWG	
	with Ferrule / Lug	0.2 - 2.5 mm ²	24 - 12 AWG	
With 2 same size Conductors per clamp	with TWIN Ferrule / Lug	0.2 - 1.5 mm ²	24 - 18 AWG	
Wire Stripping Length	9 mm			
Ratings As Per	IEC60947-7-1	UL-1059	CSA22.2-158	IEC60079-7
Voltage	1000 V	600 V	600 V	630 V
Current	24 A	20 A	20 A	21 A
Approval				
Insulation Material / Material Group	Polyamide 6,6 / 1			
Rated Impulse Voltage / Pollution Degree	8 KV / 3			



		Type / Cat. No.	Standard Pack
Terminal Block	Grey	CXS2.5	50
	Blue	CXS2.5BU	50
	Red	CXS2.5R	50
	Yellow	CXS2.5Y	50
	Black	CXS2.5BK	50
	Green	CXS2.5GN	50
	Ground / Earth	CXSG2.5	50
End Plate		EPCXS2.5	50
Mounting Rail	(Refer Pg. 217 for details)	CA701-1M / CA701-1M-S	50 m
End Clamp	(Refer Pg. 218 for details)	CA103 / CA104	50
Marking Tags	(Refer Pg. 222 for details)	CA509/K5WHT	100
Screw Driver		SCM0.5/3 Blade size: 0.5 x 3 mm	10

		Type / Cat. No.	I _{max}	Standard Pack	
Pluggable Jumpers	2 pole	JX2.5/2	24 A	100	
	3 pole	JX2.5/3	24 A	50	
	4 pole	JX2.5/4	24 A	50	
	5 pole	JX2.5/5	24 A	50	
	6 pole	JX2.5/6	24 A	10	
	7 pole	JX2.5/7	24 A	10	
	8 pole	JX2.5/8	24 A	10	
	10 pole	JX2.5/10	24 A	10	
	Test Plug		TX2.5		20

CXS4



6 x 45.9 mm
43.5 mm / 50.8 mm

IEC	UL - CSA
0.2 - 4.0 mm ²	24 - 10 AWG
0.2 - 6.0 mm ²	
0.2 - 4.0 mm ²	24 - 10 AWG
0.2 - 1.5 mm ²	24 - 18 AWG

10 mm

IEC60947-7-1 UL-1059

1000 V	600 V
32 A	30 A



Polyamide 6,6 / 1
8 KV / 3

CXSG2.5



5 x 45.9 mm
43.5 mm / 50.8 mm

IEC	UL - CSA
0.2 - 2.5 mm ²	24 - 12 AWG
0.2 - 4.0 mm ²	24 - 10 AWG
0.2 - 2.5 mm ²	24 - 12 AWG
0.2 - 1.5 mm ²	24 - 18 AWG

9 mm



Polyamide 6,6 / 1
8 KV / 3

CXSG4



6 x 45.9 mm
43.5 mm / 50.8 mm

IEC	UL - CSA
0.2 - 4.0 mm ²	24 - 10 AWG
0.2 - 6.0 mm ²	
0.2 - 4.0 mm ²	24 - 10 AWG
0.2 - 1.5 mm ²	24 - 18 AWG

10 mm



Polyamide 6,6 / 1
8 KV / 3

Type / Cat. No.	Standard Pack
CXS4	50
CXSG4	50
EPCXS2.5	50
CA701-1M / CA701-1M-S	50 m
CA701-15-1M / CA701-15-1M-S	25 m
CA103 / CA104	50
CA509/K6WHT	100
SCM0.5/3 Blade size: 0.5 x 3 mm	10

Type / Cat. No.	Standard Pack
CXSG2.5	50
EPCXS2.5	50
CA701-1M / CA701-1M-S	50 m
CA701-15-1M / CA701-15-1M-S	25 m
CA103 / CA104	50
CA509/K5WHT	100
SCM0.5/3 Blade size: 0.5 x 3 mm	10

Type / Cat. No.	Standard Pack
CXSG4	50
EPCXS2.5	50
CA701-1M / CA701-1M-S	50 m
CA701-15-1M / CA701-15-1M-S	25 m
CA103 / CA104	50
CA509/K6WHT	100
SCM0.5/3 Blade size: 0.5 x 3 mm	10

Type / Cat. No.	I _{max}	Standard Pack
JX4/2	32 A	100
JX4/3	32 A	50
JX4/4	32 A	50
JX4/8	32 A	10
JX4/10	32 A	10

Type / Cat. No.	I _{max}	Standard Pack
JX2.5/2	24 A	100
JX2.5/3	24 A	50
JX2.5/4	24 A	50
JX2.5/5	24 A	50
JX2.5/6	24 A	10
JX2.5/7	24 A	10
JX2.5/8	24 A	10
JX2.5/10	24 A	10
TX2.5		20

Type / Cat. No.	I _{max}	Standard Pack
JX4/2	32 A	100
JX4/3	32 A	50
JX4/4	32 A	50
JX4/8	32 A	10
JX4/10	32 A	10

COMPACT HYBRID DISTRIBUTION TERMINAL BLOCK

CXDB35/10 is a compact Distribution Terminal Block. It is designed to suit standard Miniature Circuit Breaker (MCB) distribution boxes.

The terminal block is capable of accepting 35 mm² cables at the input side and 4 wires of 10 mm² can be connected at the output side.

The input cable is connected with a standard screw clamp system and the output wires can be connected with quick and reliable Spring clamp connections.

CXDB35/10 is a modular system and standard JX series jumpers can be used to add more connection points.

For distribution applications please note that the total system current should not exceed the allowed 125 A criteria.

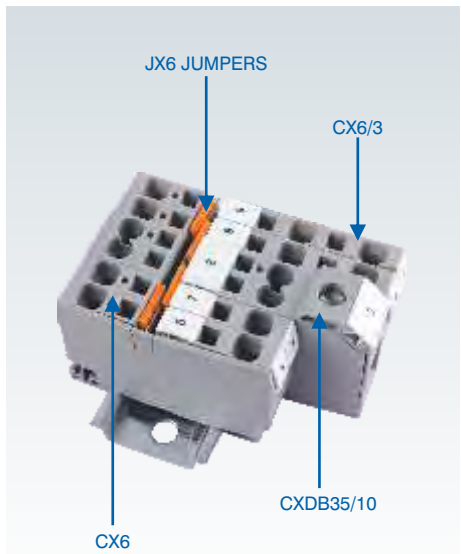

CXDB35/10

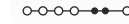
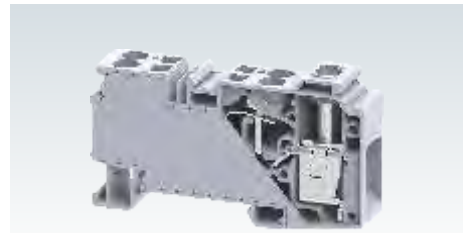

Width (Thickness) x Length	16 X 81.6 mm
Height with DIN 35 x 7.5 / 35 x 15 Rail	46.8 mm / 54.3 mm

Connection Possibility at Input as per	
With 1 Conductor per clamp	Stranded / Flexible with Ferrule / Lug
With 2 same size Conductors per clamp	Stranded / Flexible with TWIN Ferrule / Lug
Wire Stripping Length	17 mm

IEC	UL - CSA
1.5 - 35.0 mm ²	14 - 2 AWG
1.5 - 35.0 mm ²	14 - 2 AWG
4.0 - 16.0 mm ²	12 - 4 AWG
4.0 - 16.0 mm ²	12 - 8 AWG
Wire Stripping Length	17 mm

Connection Possibility at Output as per	
With 1 Conductor per clamp	Stranded / Flexible Solid with Ferrule / Lug
With 2 same size Conductors per clamp	with TWIN Ferrule / Lug
Wire Stripping Length	15 mm

IEC	UL - CSA
0.2 - 10.0 mm ²	24 - 8 AWG
0.2 - 10.0 mm ²	24 - 8 AWG
0.2 - 4.0 mm ²	24 - 12 AWG
Wire Stripping Length	15 mm

Ratings at Input As Per	
Voltage	1000 V
Current	125 A
Torque	2.5 Nm

IEC60947-7-1	UL-1059	CSA22.2-158
1000 V	600 V	600 V
125 A	115 A	115 A
2.5 Nm	25 lb-in	25 lb-in

Ratings at Output As Per	
Voltage	1000 V
Current	41 A

IEC60947-7-1	UL-1059	CSA22.2-158
1000 V	600 V	600 V
41 A	41 A	41 A

Approvals	
Insulation Material / Material Group	Polyamide 6,6 / 1
Rated Impulse Voltage / Pollution Degree	8 KV / 3

Insulation Material / Material Group	Polyamide 6,6 / 1
Rated Impulse Voltage / Pollution Degree	8 KV / 3

Terminal Block	With Slotted Screw With Allen Screw	
Mounting Rail	(Refer Pg. 217 for details)	
End Clamp	(Refer Pg. 218 for details)	
Marking Tags	(Refer Pg. 222 for details)	
Screw Driver	Screw Clamp Spring Clamp	

Type / Cat. No.	Standard Pack
CXDB35/10	20
CXDB35/10A	20
CA701-1M / CA701-1M-S	50 m
CA701-15-1M / CA701-15-1M-S	25 m
CA702 / CA802 / CA202	50
CA509/K16WHT	100
SCM1/5.5	Blade size: 1.0 x 5.5 mm
SCM0.8/4	Blade size: 0.8 x 4 mm

Jumpers		
Pluggable Jumpers		2 pole
		3 pole
		4 pole
		10 pole
Step Down Jumpers		6 - 2.5 mm ² 6 - 4 mm ² 10 - 6 mm ²

Type / Cat. No.	I _{max}	Standard Pack
JX6/2	41 A	100
JX6/3	41 A	50
JX6/4	41 A	50
JX6/10	41 A	10
JXS6/2.5	24 A	50
JXS6/4	32 A	50
JXS10/6	41 A	50

COMPONENT CARRIER TERMINAL BLOCKS

CXCC4 Spring Clamp Terminal Block is a component carrier base. Various pluggable component carriers can be installed easily. These component carriers have built in protection against incorrect polarity.

Width (Thickness) x Length		6 x 65.4 mm			
Height with DIN 35 x 7.5 / 35 x 15 mm Rail		61.5 mm / 69 mm			
Connection Possibility as per		IEC		UL - CSA	
With 1 Conductor per clamp	Stranded / Flexible	0.2 - 4.0 mm ²	24 - 10 AWG		
	Solid with Ferrule / Lug	0.2 - 6.0 mm ²	24 - 10 AWG		
With 2 same size Conductors per clamp	with TWIN Ferrule / Lug	0.2 - 1.5 mm ²	24 - 14 AWG		
Wire Stripping Length		10 mm			
Ratings As Per		IEC60947-7-1	UL-1059	CSA22.2-158	IEC60079-7
Voltage		1000 V	600 V	600 V	630 V
Current		*	*	*	*
Approval					
Insulation Material / Material Group		Polyamide 6,6 / 1			
Rated Impulse Voltage / Pollution Degree		4 KV / 3			



Type / Cat. No.	Standard Pack
CXCC4	50
CA701-1M / CA701-1M-S	50 m
CA701-15-1M / CA701-15-1M-S	25 m
CA702	50
CA802	50
CA103	50
JX4/2	I _{max.} : 32 A
JX4/3	32 A
JX4/4	32 A
JX4/8	32 A
JX4/10	32 A
CA509/K6WHT	100
SCM0.5/3	Blade size: 0.5 x 3 mm
	10

Current Rating applicable when used with plug CPD1, CPF & CIP

Type / Cat. No.	Standard Pack	
Terminal Block	CXCC4	50
Mounting Rail (Refer Pg. 217 for details)	CA701-1M / CA701-1M-S	50 m
	CA701-15-1M / CA701-15-1M-S	25 m
End Clamp (Refer Pg. 218 for details)	CA702	50
	CA802	50
	CA103	50
	JX4/2	I _{max.} : 32 A
Shorting Link	JX4/3	32 A
	JX4/4	32 A
	JX4/8	32 A
	JX4/10	32 A
	Marking Tags (Refer Pg. 222 for details)	CA509/K6WHT
Screw Driver	SCM0.5/3	Blade size: 0.5 x 3 mm
		10

* Current Rating based on component carriers

CPD1 is component plug with built in diode 1N4007. CPF is component fuse plug suitable for Ø 5 x 20 mm fuses. CPFL is component plug which provides offline indication in case of a blown off fuse. CIP is a disconnecting plug which can be installed in the base Terminal Block CCC4U.

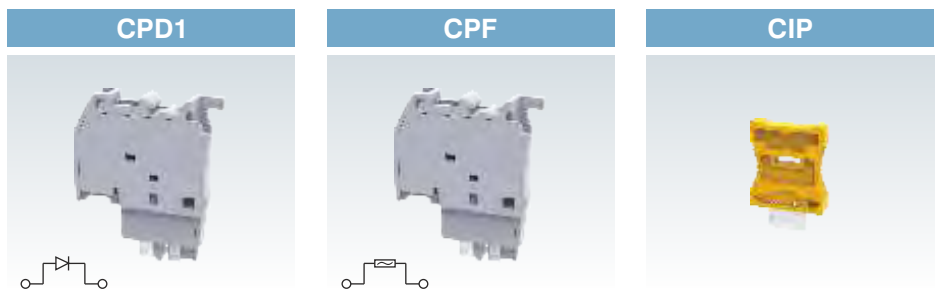

Component Carrier	Type / Cat. No.	Std. Pack	Type / Cat. No.	Std. Pack	Type / Cat. No.	Std. Pack
Component Carrier	CPD1	50	CPF	50	CIP	50
With Diode For Ø 5 x 20 mm Fuse			CPFL6-60V	50		
Fuse with 6-60V AC/DC LED Circuit			CPFL110-240V	50		
Fuse with 110-240V AC/DC LED Circuit						
Disconnection Plug						
Width (Thickness) x Length x Height	6 x 28 x 35 mm		6 x 28 x 35 mm		5.4 x 17.45 x 26 mm	
* Current Rating	1 A		6.3 A		10 A	
Marking Tags (Refer Pg. 222 for details)	CA509/K6WHT	100	CA509/K6WHT	100		

PLUGGABLE TERMINAL BLOCKS

Connectwell pluggable series Terminal Blocks are an excellent solution for creating wire harnesses which ease field wire connections.

CX2.5/1B terminal is DIN rail mounted base Terminal Block. Standard Jumpers and marking tags can be installed on the base terminal. The base Terminal Block has a provision for installing CX2.5PN series plugs.

CXDL2.5/2B terminal is a double level DIN rail mounted base Terminal Block. Standard Jumpers and marking tags can be installed on the base terminal. The base Terminal Block has a provision for installing CX2.5PN series plugs.

CX2.5PN series plugs can be inserted in standard base Terminal Blocks. CX2.5PLN should be used as a last covering element along with CX2.5PN terminals to make a complete assembly.

These plug assemblies can be polarized by cutting the integral stubs.

Subsequently standard polarizing pins CXPOLN can be used in the base Terminal Block to receive these polarized plugs.

CXLPN locking clips are installed on the plugs to ensure positive engagement with the base Terminal Block.

CXSR series strain relief plates are used in conjunction with the plug assemblies to secure wires using standard wire ties.







CX2.5SN is a free floating base terminal. CXDIN mounting feet can be installed on this free floating base terminal to enable mounting on DIN rails.







Various wire and plug receptacle base terminal options are available to create unique wire harnessing solutions.

Standard green yellow ground/earth base Terminal Blocks are also available for grounding applications.

Width (Thickness) x Length	
Height with DIN 35 x 7.5 / 35 x 15 mm Rail	
Connection Possibility as per	
With 1 Conductor per clamp	Stranded / Flexible
	Solid with Ferrule / Lug
With 2 same size Conductors per clamp	with TWIN Ferrule / Lug
Wire Stripping Length	
Ratings As Per	
Voltage	
Current	
Approval	
Insulation Material / Material Group	
Rated Impulse Voltage / Pollution Degree	

Terminal Block	Grey
----------------	------

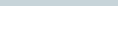
Terminal Block	Ground / Earth
End Plate	
Partition Plate	
Mounting Rail (Refer Pg. 217 for details)	
End Clamp (Refer Pg. 218 for details)	
Warning Label	
Marking Tags (Refer Pg. 222 for details)	
Coding Pin	
Screw Driver	

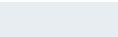
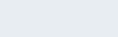
Jumpers	
Pluggable Jumpers	
	
	
	
	
	
	
	
	Test Plug

CX2.5/1B



5 x 50.8 mm			
38.2 mm / 45.7 mm			
IEC	UL - CSA		
0.2 - 2.5 mm ²	24 - 12 AWG		
0.2 - 4.0 mm ²	24 - 10 AWG		
0.2 - 2.5 mm ²	24 - 12 AWG		
0.2 - 1.0 mm ²	24 - 20 AWG		
10 mm			
IEC60947-7-1	UL-1059	CSA22.2-158	IEC60079-7
500 V	300 V	600 V	630 V
24 A	20 A	20 A	21 A
			
Polyamide 6,6 / 1			
8 KV / 3			

Type / Cat. No.	Standard Pack
CX2.5/1B	100

CXG2.5/1B



Type / Cat. No.	Standard Pack
CXG2.5/1B	100
EPCX2.5	50
PPCX4	20
CA701-1M / CA701-1M-S	50 m
CA701-15-1M / CA701-15-1M-S	25 m
CA103 / CA104	50
WLX2.5	100
CA509/K5WHT	100
CXPOLN	25
SCM0.5/3	Blade size: 0.5 x 3 mm
	10

Type / Cat. No.	Imax	Standard Pack
JX2.5/2	24 A	100
JX2.5/3	24 A	50
JX2.5/4	24 A	50
JX2.5/5	24 A	50
JX2.5/6	24 A	10
JX2.5/7	24 A	10
JX2.5/8	24 A	10
JX2.5/10	24 A	10
TX2.5		20

CX2.5/2B



5 x 51.2 mm

38.2 mm / 45.7 mm

IEC	UL - CSA
0.2 - 2.5 mm ²	24 - 12 AWG
0.2 - 4.0 mm ²	24 - 10 AWG
0.2 - 2.5 mm ²	24 - 12 AWG

0.2 - 1.0 mm² 24 - 20 AWG

10 mm

IEC60947-7-1 UL-1059 CSA22.2-158 IEC60079-7

500 V	300 V	600 V	630 V
24 A	20 A	20 A	21 A



Polyamide 6,6 / 1

8 KV / 3

Type / Cat. No.	Standard Pack
CX2.5/2B	100

CX2.5/3/1B



5 x 63 mm

38.2 mm / 45.7 mm

IEC	UL - CSA
0.2 - 2.5 mm ²	24 - 12 AWG
0.2 - 4.0 mm ²	24 - 10 AWG
0.2 - 2.5 mm ²	24 - 12 AWG

0.2 - 1.0 mm² 24 - 20 AWG

10 mm

IEC60947-7-1 UL-1059 CSA22.2-158 IEC60079-7

500 V	300 V	600 V	630 V
24 A	20 A	20 A	21 A



Polyamide 6,6 / 1

8 KV / 3

Type / Cat. No.	Standard Pack
CX2.5/3/1B	100

CX2.5/4/2B

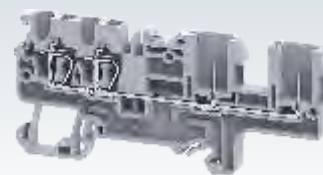

5 x 83.5 mm

38.2 mm / 45.7 mm

IEC	UL - CSA
0.2 - 2.5 mm ²	24 - 12 AWG
0.2 - 4.0 mm ²	24 - 10 AWG
0.2 - 2.5 mm ²	24 - 12 AWG

0.2 - 1.0 mm² 24 - 20 AWG

10 mm

IEC60947-7-1 UL-1059 CSA22.2-158 IEC60079-7

500 V	300 V	600 V	630 V
24 A	20 A	20 A	21 A



Polyamide 6,6 / 1

8 KV / 3

Type / Cat. No.	Standard Pack
CX2.5/4/2B	50

CXG2.5/2B



Type / Cat. No.	Standard Pack
CXG2.5/2B	100
EPCX2.5	50
PPCX4	20
CA701-1M / CA701-1M-S	50 m
CA701-15-1M / CA701-15-1M-S	25 m
CA103 / CA104	50
WLX2.5	100
CA509/K5WHT	100
CXPOLN	25
SCM0.5/3 Blade size: 0.5 x 3 mm	10

Type / Cat. No.	I _{max}	Standard Pack
JX2.5/2	24 A	100
JX2.5/3	24 A	50
JX2.5/4	24 A	50
JX2.5/5	24 A	50
JX2.5/6	24 A	10
JX2.5/7	24 A	10
JX2.5/8	24 A	10
JX2.5/10	24 A	10
TX2.5		20

CXG2.5/3/1B



Type / Cat. No.	Standard Pack
CXG2.5/3/1B	100
EPCX2.5/3	50
PPCX4/3	20
CA701-1M / CA701-1M-S	50 m
CA701-15-1M / CA701-15-1M-S	25 m
CA103 / CA104	50
WLX2.5	100
CA509/K5WHT	100
CXPOLN	25
SCM0.5/3 Blade size: 0.5 x 3 mm	10

Type / Cat. No.	I _{max}	Standard Pack
JX2.5/2	24 A	100
JX2.5/3	24 A	50
JX2.5/4	24 A	50
JX2.5/5	24 A	50
JX2.5/6	24 A	10
JX2.5/7	24 A	10
JX2.5/8	24 A	10
JX2.5/10	24 A	10
TX2.5		20

CXG2.5/4/2B





Type / Cat. No.	Standard Pack
CXG2.5/4/2B	100
EPCX2.5/4/2B	50
CA701-1M / CA701-1M-S	50 m
CA701-15-1M / CA701-15-1M-S	25 m
CA103 / CA104	50
WLX2.5	100
CA509/K5WHT	100
CXPOLN	25
SCM0.5/3 Blade size: 0.5 x 3 mm	10

Type / Cat. No.	I _{max}	Standard Pack
JX2.5/2	24 A	100
JX2.5/3	24 A	50
JX2.5/4	24 A	50
JX2.5/5	24 A	50
JX2.5/6	24 A	10
JX2.5/7	24 A	10
JX2.5/8	24 A	10
JX2.5/10	24 A	10
TX2.5		20

PLUGGABLE TERMINAL BLOCKS

Width (Thickness) x Length		
Height with DIN 35 x 7.5 / 35 x 15 mm Rail		
Connection Possibility as per		
With 1 Conductor per clamp	Stranded / Flexible	
	Solid	
	with Ferrule / Lug	
With 2 same size Conductors per clamp	with TWIN Ferrule / Lug	
Wire Stripping Length		
Ratings As Per		
Voltage		
Current		
Approval		
Insulation Material / Material Group		
Rated Impulse Voltage / Pollution Degree		

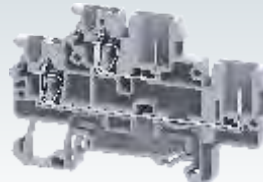

CX2.5/4/4B				
				
				
5 x 97.2 mm				
38.2 mm / 45.7 mm				
IEC		UL - CSA		
0.2 - 2.5 mm ²		24 - 12 AWG		
0.2 - 4.0 mm ²		24 - 10 AWG		
0.2 - 2.5 mm ²		24 - 12 AWG		
0.2 - 1.0 mm ²		24 - 20 AWG		
10 mm				
IEC60947-7-1	UL-1059	CSA22.2-158	IEC60079-7	
500 V	300 V	600 V	630 V	
24 A	20 A	20 A	21 A	
				
Polyamide 6,6 / 1				
8 KV / 3				

CXDL2.5/2B				
				
				
5 x 78 mm				
49.5 mm / 57 mm				
IEC		UL - CSA		
0.2 - 2.5 mm ²		24 - 12 AWG		
0.2 - 4.0 mm ²		24 - 10 AWG		
0.2 - 2.5 mm ²		24 - 12 AWG		
0.2 - 1.0 mm ²		24 - 20 AWG		
10 mm				
IEC60947-7-1	UL-1059	CSA22.2-158	IEC60079-7	
500 V	300 V	600 V	630 V	
24 A	20 A	20 A	21 A	
				
Polyamide 6,6 / 1				
8 KV / 3				



Terminal Block	Grey
----------------	------

Type / Cat. No.	Standard Pack
CX2.5/4/4B	50

Type / Cat. No.	Standard Pack
CXDL2.5/2B	50

CXG2.5/4/4B	
	
	
50	
50	
50 m	
25 m	
50	
100	
100	
25	
10	
Jumpers	
Pluggable Jumpers	2 pole
	3 pole
	4 pole
	5 pole
	6 pole
	7 pole
	8 pole
10 pole	
Test Plug	

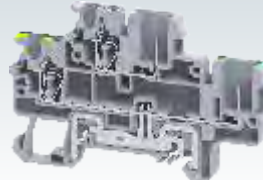
Type / Cat. No.	Standard Pack	
CXG2.5/4/4B	50	
EPCX2.5/4/4B	50	
CA701-1M / CA701-1M-S	50 m	
CA701-15-1M / CA701-15-1M-S	25 m	
CA103 / CA104	50	
WLX2.5	100	
CA509/K5WHT	100	
CXPOLN	25	
SCM0.5/3 Blade size: 0.5 x 3 mm	10	
Type / Cat. No.	I _{max}	Standard Pack
JX2.5/2	24 A	100
JX2.5/3	24 A	50
JX2.5/4	24 A	50
JX2.5/5	24 A	50
JX2.5/6	24 A	10
JX2.5/7	24 A	10
JX2.5/8	24 A	10
JX2.5/10	24 A	10
TX2.5		20

CXDLG2.5/2B		
		
		
50		
50		
50 m		
25 m		
50		
100		
100		
25		
10		
Type / Cat. No.	I _{max}	Standard Pack
JX2.5/2	24 A	100
JX2.5/3	24 A	50
JX2.5/4	24 A	50
JX2.5/5	24 A	50
JX2.5/6	24 A	10
JX2.5/7	24 A	10
JX2.5/8	24 A	10
JX2.5/10	24 A	10
TX2.5		20

CXDL2.5/2B(I.S)

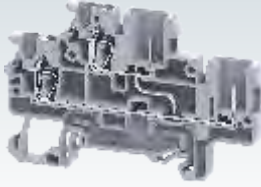

5 x 78 mm

49.5 mm / 57 mm

IEC	UL - CSA
0.2 - 2.5 mm ²	24 - 12 AWG
0.2 - 4.0 mm ²	24 - 10 AWG
0.2 - 2.5 mm ²	24 - 12 AWG
0.2 - 1.0 mm ²	24 - 20 AWG

10 mm

IEC60947-7-1	UL-1059	CSA22.2-158	IEC60079-7
500 V	300 V	600 V	630 V
24 A	20 A	20 A	21 A



Polyamide 6,6 / 1

8 KV / 3

Type / Cat. No.

Standard Pack

CXDL2.5/2B(I.S)

50

CXDLG2.5/2B(I.S)

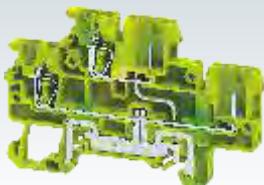

Type / Cat. No.

Standard Pack

CXDLG2.5/2B(I.S)

50

EPCXDL2.5/2B

50

CA701-1M / CA701-1M-S

50 m

CA701-15-1M / CA701-15-1M-S

25 m

CA103 / CA104

50

WLX2.5

100

CA509/K5WHT

100

CXPOLN

25

SCM0.5/3 Blade size: 0.5 x 3 mm

10

Type / Cat. No.

I_{max}

Standard Pack

JX2.5/2

24 A

100

JX2.5/3

24 A

50

JX2.5/4

24 A

50

JX2.5/5

24 A

50

JX2.5/6

24 A

10

JX2.5/7

24 A

10

JX2.5/8

24 A

10

JX2.5/10

24 A

10

TX2.5

20

CXSR2N

CX2.5PN

CX2.5PLN

CX2.5/1B

CXLPN

EPCX2.5

1



Insert coding pin CXPOLN in the base Terminal Block. Twist to break.

2



Remove the coding pin from female plug using a cutting tool

3

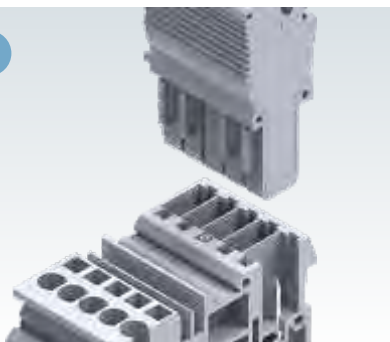

Polarized plug assemblies can then be inserted in the respective base terminal

PLUGGABLE TERMINAL BLOCKS

CX2.5PN



CX2.5SN



Width (Thickness) x Length	5 x 17.5 mm		5 (With End Plate 7.5 mm) x 18 mm		
Height	42 mm		40 mm		
Connection Possibility as per	IEC	UL - CSA	IEC	UL - CSA	
		With 1 Conductor per clamp		Stranded / Flexible	0.2 - 2.5 mm ²
		Solid		0.2 - 4.0 mm ²	24 - 12 AWG
		with Ferrule / Lug		0.2 - 2.5 mm ²	24 - 12 AWG
With 2 same size Conductors per clamp	with TWIN Ferrule / Lug	0.2 - 1.5 mm ²	24 - 16 AWG	0.2 - 1.5 mm ²	24 - 16 AWG
Wire Stripping Length	10 mm		10 mm		
Ratings As Per	IEC60947-7-1	UL-1059	IEC60947-7-1	UL-1059	
Voltage	500 V	300 V	500 V	300 V	
	Current	24 A	20 A	24 A	20 A
Approvals					
Insulation Material / Material Group	Polyamide 6,6 / 1		Polyamide 6,6 / 1		
Rated Impulse Voltage / Pollution Degree	8 KV / 3		8 KV / 3		

No. of Poles			Type / Cat. No.	Standard Pack	Type / Cat. No.	Standard Pack		
Connector	Start Element	1	CX2.5PN	50	CX2.5SN	50		
	Last Element	1	CX2.5PLN	50				
		2	CX2.5PN/2	50	CX2.5SN/2	50		
		3	CX2.5PN/3	50	CX2.5SN/3	50		
		4	CX2.5PN/4	50	CX2.5SN/4	50		
		5	CX2.5PN/5	50	CX2.5SN/5	50		
		6	CX2.5PN/6	25	CX2.5SN/6	25		
		7	CX2.5PN/7	25	CX2.5SN/7	25		
		8	CX2.5PN/8	25	CX2.5SN/8	25		
		9	CX2.5PN/9	25	CX2.5SN/9	25		
		10	CX2.5PN/10	25	CX2.5SN/10	25		
		11	CX2.5PN/11	10	CX2.5SN/11	10		
		12	CX2.5PN/12	10	CX2.5SN/12	10		
		13	CX2.5PN/13	10	CX2.5SN/13	10		
		14	CX2.5PN/14	10	CX2.5SN/14	10		
	15	CX2.5PN/15	10	CX2.5SN/15	10			
End Plate					EPCX2.5SN	50		
Locking Clip			CXLPN	25				
2 Way Strain Relief			CXSR2N	25	CXSR2N	25		
4 Way Strain Relief			CXSR4N	25	CXSR4N	25		
Mounting Feet					CXDIN	25		
Coding Pin					CXPOLN	25		
Mounting Rail (Refer Pg. 217 for details)			CA701-1M / CA701-1M-S	50 m	CA701-1M / CA701-1M-S	50 m		
			CA701-15-1M / CA701-15-1M-S	25 m	CA701-15-1M / CA701-15-1M-S	25 m		
End Clamp (Refer Pg. 218 for details)			CA103 / CA104	50	CA103 / CA104	50		
Screw Driver for actuating the Spring Clamp			SCM0.5/3	Blade size: 0.5 x 3 mm	10	SCM0.5/3	Blade size: 0.5 x 3 mm	10
Actuator for actuating the Spring Clamp			SCA2.5		1	SCA2.5		1
Marking Tags (Refer Pg. 222 for details)			CA509/K5WHT		100	CA509/K5WHT		100

VIRTUAL **config**

DESIGN

DOCUMENT

MANUFACTURE

DELIVER

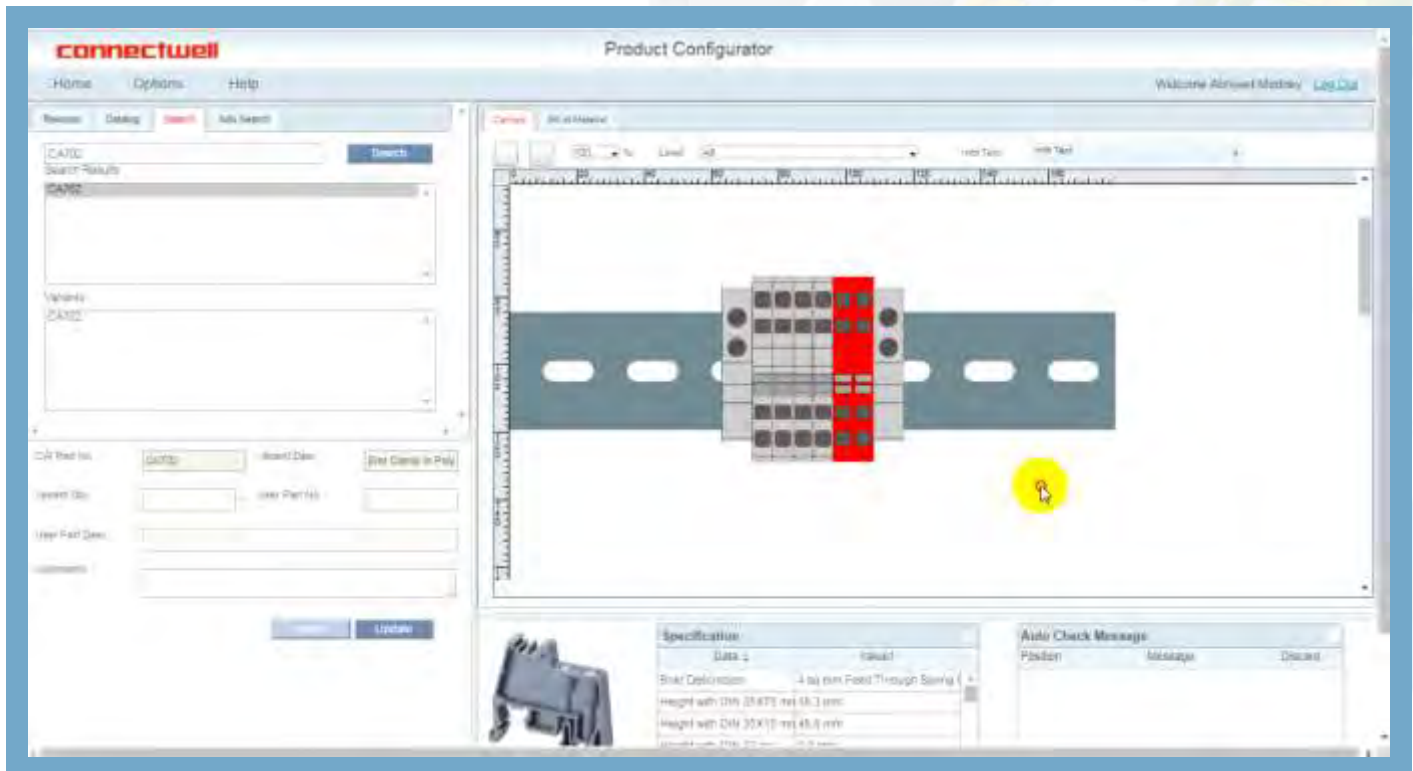

- > Free online tool for Terminal Block configuration
- > Easy to use software, menu driven, no CAD licencing required
- > 2D & 3D output drawing generation
- > Complete BOM documentation
- > Short manufacturing lead time
- > Standardized packaging for configured rail assemblies

<http://www.connectwell.com/Global/product-configurator.aspx>



ANGULAR FEED THROUGH TERMINAL BLOCKS

These Terminal Blocks are an ideal choice for compact junction boxes having limitations of space and height. These terminals are also used for underfloor wiring systems.

A major advantage of Angular Terminal Blocks over the top wire entry Terminal Blocks is that their profile remains the same across the entire range of Feed Through, Multiple Connection, Ground and Ground Multiple Connection Terminal Blocks.

The other advantages include: Angular entry of wires saves conductor length, marking / identification facility on the center (top) of the block, Multiplication of connections through bridging.

Step Down Jumpers are used for shorting spring clamp Terminal Blocks of different sizes. For more details refer page 233.





The terminals with  & IECEx approval can be used in potentially explosive atmosphere. For detailed information refer page 243.

Width (Thickness) x Length	
Height with DIN 35 x 7.5 / 35 x 15 mm Rail	
Connection Possibility as per	
With 1 Conductor per clamp	Stranded / Flexible Solid with Ferrule / Lug
With 2 same size Conductors per clamp	with TWIN Ferrule / Lug
Wire Stripping Length	
Ratings As Per	
Voltage	
Current	
Approvals	
Insulation Material / Material Group	
Rated Impulse Voltage / Pollution Degree	





AS2.5



5 x 54 mm			
44.0 mm / 51.0 mm			
IEC		UL - CSA	
0.34 - 2.5 mm ²	0.34 - 4.0 mm ²	22 - 12 AWG	22 - 10 AWG
0.34 - 2.5 mm ²		22 - 12 AWG	
0.34 - 1.5 mm ²		22 - 14 AWG	
11 mm			
IEC60947-7-1 UL-1059 CSA22.2-158 IEC 60079-7			
800 V	600 V	600 V	630 V
24 A	25 A	25 A	21 A
			
Polyamide 6,6 / 1			
8 KV / 3			

Terminal Block	Grey Blue Red Yellow Black Green Ground / Earth
End Plate	
Mounting Rail (Refer Pg. 217 for details)	
End Clamp (Refer Pg. 218 for details)	
Marking Tags (Refer Pg. 222 for details)	
Screw Driver	

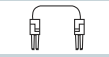
Type / Cat. No.	Standard Pack
AS2.5	100
AS2.5BU	100
AS2.5R	100
AS2.5Y	100
AS2.5BK	100
AS2.5GN	100
AGT2.5 (Refer Pg. 135 for details)	100
EPAS2.5	50
CA701-1M / CA701-1M-S	50 m
CA701-15-1M / CA701-15-1M-S	25 m
CA103 / CA104	50
CA509/K5WHT	100
SCM0.5/3 Blade size: 0.5 x 3.0 mm	10

Jumpers	
Adjacent Jumper	
Alternate Jumper	
Insulated wire type pluggable jumpers	
Step Down Jumpers	

Type / Cat. No.	I _{max}	Standard Pack
CA801/1	24 A	100
CA801/1-3	24 A	100
CA901/1	17.5 A	100
CA901/5	32 A	100
CA901/6	32 A	100

AS4



6 x 61.5 mm
44.0 mm / 51.0 mm

IEC	UL - CSA
0.2 - 4.0 mm ²	22 - 10 AWG
0.2 - 6.0 mm ²	
0.2 - 4.0 mm ²	22 - 10 AWG
0.2 - 2.5 mm ²	22 - 12 AWG

15 mm			
IEC60947-7-1	UL-1059	CSA22.2-158	IEC 60079-7
800 V	600 V	600 V	630 V
32 A	35 A	35 A	28 A



Polyamide 6,6 / 1
8 KV / 3

AS6



8 x 74 mm
49.3 mm / 57.0 mm

IEC	UL - CSA
0.2 - 6.0 mm ²	22 - 8 AWG
0.2 - 6.0 mm ²	
0.2 - 6.0 mm ²	22 - 8 AWG
0.2 - 4.0 mm ²	22 - 10 AWG

15 mm			
IEC60947-7-1	UL-1059	CSA22.2-158	IEC 60079-7
800 V	600 V	600 V	630 V
41 A	50 A	50 A	36 A



Polyamide 6,6 / 1
8 KV / 3

AS2.5/3



5 x 54 mm
44.0 mm / 51.0 mm

IEC	UL - CSA
0.34 - 2.5 mm ²	22 - 12 AWG
0.34 - 4.0 mm ²	22 - 10 AWG
0.34 - 2.5 mm ²	22 - 12 AWG
0.34 - 1.5 mm ²	22 - 14 AWG

11 mm			
IEC60947-7-1	UL-1059	CSA22.2-158	IEC 60079-7
800 V	600 V	600 V	630 V
24 A	25 A	25 A	21 A



Polyamide 6,6 / 1
8 KV / 3

Type / Cat. No.	Standard Pack
AS4	100
AS4BU	100
AS4R	100
AS4Y	100
AS4BK	100
AS4GN	100
AGT4 (Refer Pg. 136 for details)	100
EPAS4	50
CA701-1M / CA701-1M-S	50 m
CA701-15-1M / CA701-15-1M-S	25 m
CA103 / CA104	50
CA509/K6WHT	100
SCM0.5/3 Blade size: 0.5 x 3 mm	10

Type / Cat. No.	Standard Pack
AS6	50
AS6BU	50
AS6R	50
AS6Y	50
AS6BK	50
AS6GN	50
AGT6 (Refer Pg. 136 for details)	50
EPAS6	50
CA701-1M / CA701-1M-S	50 m
CA701-15-1M / CA701-15-1M-S	25 m
CA103 / CA104	50
CA509/K8WHT	100
SCM0.8/4 Blade size: 0.8 x 4 mm	10

Type / Cat. No.	Standard Pack
AS2.5/3	100
AS2.5/3BU	100
AS2.5/3R	100
AS2.5/3Y	100
AS2.5/3BK	100
AS2.5/3GN	100
AGT2.5/3 (Refer Pg. 136 for details)	100
EPAS2.5	50
CA701-1M / CA701-1M-S	50 m
CA701-15-1M / CA701-15-1M-S	25 m
CA103 / CA104	50
CA509/K5WHT	100
SCM0.5/3 Blade size: 0.5 x 3 mm	10

Type / Cat. No.	I _{max}	Standard Pack
CA801/2	20 A	100
CA801/2-3	20 A	100
CA901/2	17.5 A	100
CA901/4	20 A	100
CA901/6	32 A	100

Type / Cat. No.	I _{max}	Standard Pack
CA801/3	35 A	100
CA801/3-3	30 A	100
CA901/3	30 A	100
CA901/4	30 A	100
CA901/5	32 A	100
CA801/8	41 A	100

Type / Cat. No.	I _{max}	Standard Pack
CA801/1	24 A	100
CA801/1-3	24 A	100
CA901/1	17.5 A	100
CA901/5	32 A	100
CA901/6	32 A	100



ANGULAR FEED THROUGH TERMINAL BLOCKS

AS2.5/4



AS4/3



Width (Thickness) x Length		5 x 54 mm	
Height with DIN 35 x 7.5 / 35 x 15 mm Rail		44.0 mm / 51.0 mm	
Connection Possibility as per		IEC	UL - CSA
With 1 Conductor per clamp	Stranded / Flexible	0.34 - 2.5 mm ²	22 - 12 AWG
	Solid	0.34 - 4.0 mm ²	22 - 10 AWG
	with Ferrule / Lug	0.34 - 2.5 mm ²	22 - 12 AWG
With 2 same size Conductors per clamp	with TWIN Ferrule / Lug	0.34 - 1.5 mm ²	22 - 14 AWG
Wire Stripping Length		11 mm	
Ratings As Per		IEC60947-7-1	UL-1059 CSA22.2-158 IEC 60079-7
Voltage		800 V	600 V 600 V 630 V
Current		24 A	25 A 25 A 21 A
Approvals			
Insulation Material / Material Group		Polyamide 6,6 / 1	
Rated Impulse Voltage / Pollution Degree		8 KV / 3	

Width (Thickness) x Length		6 x 61.5 mm	
Height with DIN 35 x 7.5 / 35 x 15 mm Rail		44.0 mm / 51.0 mm	
Connection Possibility as per		IEC	UL - CSA
With 1 Conductor per clamp	Stranded / Flexible	0.2 - 4.0 mm ²	22 - 10 AWG
	Solid	0.2 - 6.0 mm ²	22 - 10 AWG
	with Ferrule / Lug	0.2 - 4.0 mm ²	22 - 10 AWG
With 2 same size Conductors per clamp	with TWIN Ferrule / Lug	0.2 - 2.5 mm ²	22 - 12 AWG
Wire Stripping Length		15 mm	
Ratings As Per		IEC60947-7-1	UL-1059 CSA22.2-158 IEC 60079-7
Voltage		800 V	600 V 600 V 630 V
Current		32 A	35 A 35 A 28 A
Approvals			
Insulation Material / Material Group		Polyamide 6,6 / 1	
Rated Impulse Voltage / Pollution Degree		8 KV / 3	

Terminal Block	Grey	AS2.5/4	100
	Blue	AS2.5/4BU	100
	Red	AS2.5/4R	100
	Yellow	AS2.5/4Y	100
	Black	AS2.5/4BK	100
	Green	AS2.5/4GN	100
	Ground / Earth	AGT2.5/4 (Refer Pg. 137 for details)	100
End Plate		EPAS2.5	50
Mounting Rail (Refer Pg. 217 for details)		CA701-1M / CA701-1M-S	50 m
		CA701-15-1M / CA701-15-1M-S	25 m
End Clamp (Refer Pg. 218 for details)		CA103 / CA104	50
Marking Tags (Refer Pg. 222 for details)		CA509/K5WHT	100
Screw Driver		SCM0.5/3 Blade size: 0.5 x 3 mm	10

Terminal Block	Grey	AS4/3	100
	Blue	AS4/3BU	100
	Red	AS4/3R	100
	Yellow	AS4/3Y	100
	Black	AS4/3BK	100
	Green	AS4/3GN	100
	Ground / Earth	AGT4/3 (Refer Pg. 137 for details)	100
End Plate		EPAS4	50
Mounting Rail (Refer Pg. 217 for details)		CA701-1M / CA701-1M-S	50 m
		CA701-15-1M / CA701-15-1M-S	25 m
End Clamp (Refer Pg. 218 for details)		CA103 / CA104	50
Marking Tags (Refer Pg. 222 for details)		CA509/K6WHT	100
Screw Driver		SCM0.5/3 Blade size: 0.5 x 3 mm	10

Adjacent Jumper		CA801/2	20 A	100
Alternate Jumper		CA801/2-3	20 A	100
Insulated wire type pluggable jumpers		CA901/2	17.5 A	100
Step Down Jumpers		CA901/4	20 A	100
		CA901/6	32 A	100

Adjacent Jumper		CA801/2	20 A	100
Alternate Jumper		CA801/2-3	20 A	100
Insulated wire type pluggable jumpers		CA901/2	17.5 A	100
Step Down Jumpers		CA901/4	20 A	100
		CA901/6	32 A	100

Terminal Block	Grey	AS4/3	100
	Blue	AS4/3BU	100
	Red	AS4/3R	100
	Yellow	AS4/3Y	100
	Black	AS4/3BK	100
	Green	AS4/3GN	100
	Ground / Earth	AGT4/3 (Refer Pg. 137 for details)	100
End Plate		EPAS4	50
Mounting Rail (Refer Pg. 217 for details)		CA701-1M / CA701-1M-S	50 m
		CA701-15-1M / CA701-15-1M-S	25 m
End Clamp (Refer Pg. 218 for details)		CA103 / CA104	50
Marking Tags (Refer Pg. 222 for details)		CA509/K6WHT	100
Screw Driver		SCM0.5/3 Blade size: 0.5 x 3 mm	10

Adjacent Jumper		CA801/2	20 A	100
Alternate Jumper		CA801/2-3	20 A	100
Insulated wire type pluggable jumpers		CA901/2	17.5 A	100
Step Down Jumpers		CA901/4	20 A	100
		CA901/6	32 A	100

AS4/4

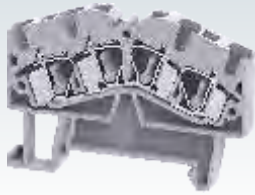

6 x 61.5 mm

44.0 mm / 51.0 mm

IEC	UL - CSA
0.2 - 4.0 mm ²	22 - 10 AWG
0.2 - 6.0 mm ²	
0.2 - 4.0 mm ²	22 - 10 AWG
0.2 - 2.5 mm ²	22 - 12 AWG

15 mm

IEC60947-7-1 UL-1059 CSA22.2-158 IEC 60079-7

800 V	600 V	600 V	630 V
32 A	35 A	35 A	28 A



Polyamide 6,6 / 1

8 KV / 3

AS6/3



8 x 74 mm

49.3 mm / 57.0 mm

IEC	UL - CSA
0.2 - 6.0 mm ²	22 - 8 AWG
0.2 - 6.0 mm ²	
0.2 - 6.0 mm ²	22 - 8 AWG
0.2 - 4.0 mm ²	22 - 10 AWG

15 mm

IEC60947-7-1 UL-1059 CSA22.2-158 IEC 60079-7

800 V	600 V	600 V	630 V
41 A	50 A	50 A	36 A



Polyamide 6,6 / 1

8 KV / 3

Type / Cat. No.	Standard Pack
AS4/4	50
AS4/4BU	50
AS4/4R	50
AS4/4Y	50
AS4/4BK	50
AS4/4GN	50
AGT4/4 (Refer Pg. 138 for details)	50
EPAS4	50
CA701-1M / CA701-1M-S	50 m
CA701-15-1M / CA701-15-1M-S	25 m
CA103 / CA104	50
CA509/K6WHT	100
SCM0.5/3 Blade size: 0.5 x 3 mm	10

Type / Cat. No.	Standard Pack
AS6/3	50
AS6/3BU	50
AS6/3R	50
AS6/3Y	50
AS6/3BK	50
AS6/3GN	50
AGT6/3 (Refer Pg. 138 for details)	50
EPAS6	50
CA701-1M / CA701-1M-S	50 m
CA701-15-1M / CA701-15-1M-S	25 m
CA103 / CA104	50
CA509/K8WHT	100
SCM0.8/4 Blade size: 0.8 x 4 mm	10

Type / Cat. No.	I _{max}	Standard Pack





Type / Cat. No.	I _{max}	Standard Pack
CA801/3	35 A	100
CA801/3-3	30 A	100
CA901/3	30 A	100
CA901/4	30 A	100
CA901/5	32 A	100
CA801/8	41 A	100



ANGULAR GROUND / EARTH TERMINAL BLOCKS

Besides having angular wire entry, these Terminal Blocks have specially designed alloy feet which help in achieving very low contact resistance and vibration proof grounding with the DIN rails. They are Green-Yellow colour coded as per industry standards.

The terminals with  & IECEx approval can be used in potentially explosive atmosphere. For detailed information refer page 243.

Width (Thickness) x Length		5 x 54 mm	
Height with DIN 35 x 7.5 / 35 x 15 mm Rail		44.0 mm / 51.6 mm	
Connection Possibility as per		IEC	UL - CSA
With 1 Conductor per clamp	Stranded / Flexible	0.34 - 2.5 mm ²	22 - 12 AWG
	Solid with Ferrule / Lug	0.34 - 4.0 mm ²	22 - 10 AWG
With 2 same size Conductors per clamp	with TWIN Ferrule / Lug	0.34 - 2.5 mm ²	22 - 12 AWG
		0.34 - 1.5 mm ²	22 - 14 AWG
Wire Stripping Length		11 mm	
Approvals			
Insulation Material / Material Group		Polyamide 6,6 / 1	
Rated Impulse Voltage / Pollution Degree		8 KV / 3	
		Type / Cat. No.	Standard Pack
Terminal Block		AGT2.5	100
End Plate 		EPAS2.5	50
Mounting Rail (Refer Pg. 217 for details) 		CA701-1M / CA701-1M-S	50 m
		CA701-15-1M / CA701-15-1M-S	25 m
Marking Tags (Refer Pg. 222 for details) 		CA509/K5WHT	100
Screw Driver 		SCM0.5/3 Blade size: 0.5 x 3 mm	10

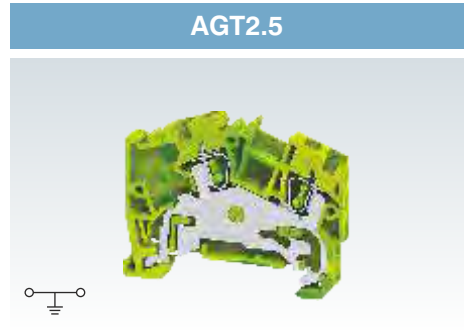

AGT4



6 x 61.5 mm

44.0 mm / 51.6 mm

IEC	UL - CSA
0.2 - 4.0 mm ²	22 - 10 AWG
0.2 - 6.0 mm ²	
0.2 - 4.0 mm ²	22 - 10 AWG
0.2 - 2.5 mm ²	22 - 12 AWG

15 mm



Polyamide 6,6 / 1

8 KV / 3

Type / Cat. No.	Standard Pack
AGT4	100
EPAS4	50
CA701-1M / CA701-1M-S	50 m
CA701-15-1M / CA701-15-1M-S	25 m
CA509/K6WHT	100
SCM0.5/3 Blade size: 0.5 x 3 mm	10

AGT6



8 x 74 mm

49.3 mm / 57.0 mm

IEC	UL - CSA
0.2 - 6.0 mm ²	22 - 8 AWG
0.2 - 6.0 mm ²	
0.2 - 6.0 mm ²	22 - 8 AWG
0.2 - 4.0 mm ²	22 - 10 AWG

15 mm



Polyamide 6,6 / 1

8 KV / 3

Type / Cat. No.	Standard Pack
AGT6	50
EPAS6	50
CA701-1M / CA701-1M-S	50 m
CA701-15-1M / CA701-15-1M-S	25 m
CA509/K8WHT	100
SCM0.8/4 Blade size: 0.8 x 4 mm	10

AGT2.5/3



5 x 54 mm

44.0 mm / 51.6 mm

IEC	UL - CSA
0.34 - 2.5 mm ²	22 - 12 AWG
0.34 - 4.0 mm ²	22 - 10 AWG
0.34 - 2.5 mm ²	22 - 12 AWG
0.34 - 1.5 mm ²	22 - 14 AWG

11 mm



Polyamide 6,6 / 1

8 KV / 3

Type / Cat. No.	Standard Pack
AGT2.5/3	100
EPAS2.5	50
CA701-1M / CA701-1M-S	50 m
CA701-15-1M / CA701-15-1M-S	25 m
CA509/K5WHT	100
SCM0.5/3 Blade size: 0.5 x 3 mm	10

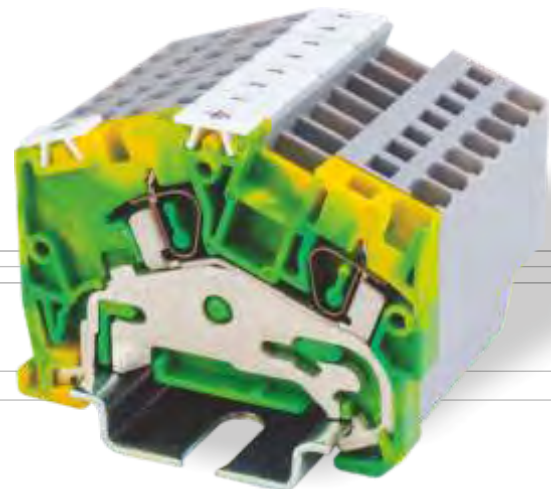

ANGULAR GROUND / EARTH TERMINAL BLOCKS

AGT2.5/4

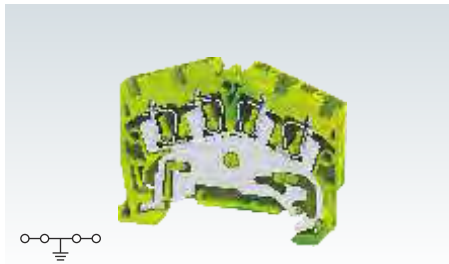

AGT4/3



Width (Thickness) x Length	5 x 54 mm		6 x 61.5 mm	
Height with DIN 35 x 7.5 / 35 x 15 mm Rail	44.0 mm / 51.6 mm		44.0 mm / 51.6 mm	
Connection Possibility as per	IEC	UL - CSA	IEC	UL - CSA
With 1 Conductor per clamp	Stranded / Flexible	0.34 - 2.5 mm ²	22 - 12 AWG	0.2 - 4.0 mm ²
	Solid	0.34 - 4.0 mm ²	22 - 10 AWG	0.2 - 6.0 mm ²
	with Ferrule / Lug	0.34 - 2.5 mm ²	22 - 12 AWG	0.2 - 4.0 mm ²
With 2 same size Conductors per clamp	with TWIN Ferrule / Lug	0.34 - 1.5 mm ²	22 - 14 AWG	0.2 - 2.5 mm ²
Wire Stripping Length	11 mm		15 mm	
Approvals				
Insulation Material / Material Group	Polyamide 6,6 / 1		Polyamide 6,6 / 1	
Rated Impulse Voltage / Pollution Degree	8 KV / 3		8 KV / 3	
	Type / Cat. No.	Standard Pack	Type / Cat. No.	Standard Pack
Terminal Block	AGT2.5/4	100	AGT4/3	100
End Plate	EPAS2.5	50	EPAS4	50
Mounting Rail (Refer Pg. 217 for details)	CA701-1M / CA701-1M-S	50 m	CA701-1M / CA701-1M-S	50 m
	CA701-15-1M / CA701-15-1M-S	25 m	CA701-15-1M / CA701-15-1M-S	25 m
Marking Tags (Refer Pg. 222 for details)	CA509/K5WHT	100	CA509/K6WHT	100
Screw Driver	SCM0.5/3 Blade size: 0.5 x 3 mm	10	SCM0.5/3 Blade size: 0.5 x 3 mm	10

AGT4/4

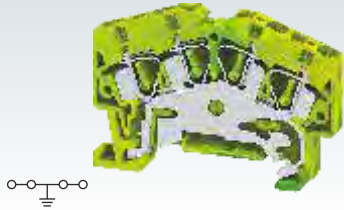

6 x 61.5 mm
44.0 mm / 51.6 mm

IEC	UL - CSA
0.2 - 4.0 mm ²	22 - 10 AWG
0.2 - 6.0 mm ²	
0.2 - 4.0 mm ²	22 - 10 AWG
0.2 - 2.5 mm ²	22 - 12 AWG

15 mm



Polyamide 6,6 / 1

8 KV / 3

Type / Cat. No.	Standard Pack
AGT4/4	100
EPAS4	50
CA701-1M / CA701-1M-S	50 m
CA701-15-1M / CA701-15-1M-S	25 m
CA509/K6WHT	100
SCM0.5/3 Blade size: 0.5 x 3 mm	10

AGT6/3



8 x 74 mm
49.3 mm / 57.0 mm

IEC	UL - CSA
0.2 - 6.0 mm ²	22 - 8 AWG
0.2 - 6.0 mm ²	
0.2 - 6.0 mm ²	22 - 8 AWG
0.2 - 4.0 mm ²	22 - 10 AWG

15 mm



Polyamide 6,6 / 1

8 KV / 3

Type / Cat. No.	Standard Pack
AGT6/3	50
EPAS6	50
CA701-1M / CA701-1M-S	50 m
CA701-15-1M / CA701-15-1M-S	25 m
CA509/K8WHT	100
SCM0.8/4 Blade size: 0.8 x 4 mm	10

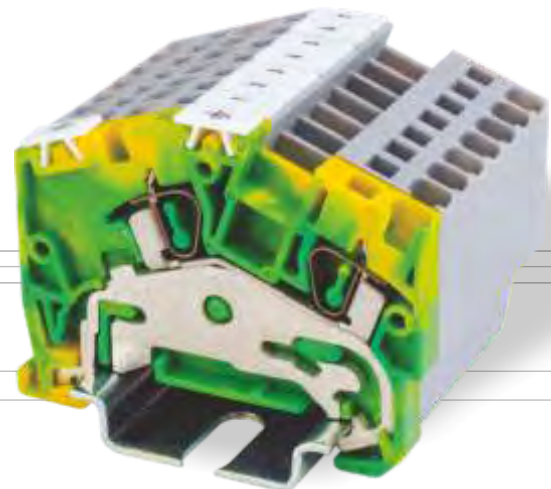

PANEL MOUNT TERMINAL BLOCKS

CM series Terminal Blocks have a side wire entry configuration. These blocks are an excellent solution for extremely compact wiring applications. The Terminal Blocks are "modular" and can be stacked to form multipole assemblies. The stacked assemblies can be mounted on the panel surface using an End Plate at one end only.

These Terminal Blocks are perfect solution for industries like Control Transformer, Elevators, Junction Boxes and applications with limited wiring space.

CSCP2.5T & CSCP2.5T2 Terminal Blocks have top wire entry. Jumpers can be easily inserted by using Spring Clamp Actuator tool SCA2.5.

The CXCP2.5/4 Terminal Block has the same profile as the CSCP2.5T terminals and can be stacked together with them. The CXCP2.5/4 terminals can be mounted on standard DIN Rails.

The terminals with  & IECEx approval can be used in potentially explosive atmosphere. For detailed information refer page 243.











Width (Thickness) x Length		5 x 26.5 mm
Height		18 mm (Panel Mount)
Connection Possibility as per		
With 1 Conductor per clamp	Stranded / Flexible	0.2 - 1.5 mm ²
	Solid with Ferrule / Lug	0.2 - 2.5 mm ²
With 2 same size Conductors per clamp	with TWIN Ferrule / Lug	0.2 - 1.5 mm ²
Wire Stripping Length		8 mm
Ratings As Per		
Voltage		500 V 300 V 300 V 320 V
Current		17 A 10 A 10 A 15 A
Approvals		
Insulation Material / Material Group		Polyamide 6,6 / 1
Rated Impulse Voltage / Pollution Degree		6 KV / 3

CM1.5S



IEC		UL - CSA	
0.2 - 1.5 mm ²	0.2 - 2.5 mm ²	24 - 16 AWG	
0.2 - 1.5 mm ²		24 - 16 AWG	
0.2 - 0.5 mm ²		24 - 20 AWG	
IEC60947-7-1 UL-1059 CSA22.2-158 IEC60079-7			

Type / Cat. No.	Standard Pack
CM1.5S	100
CM1.5SBU	100
CM1.5SR	100
CM1.5SY	100
CM1.5SBK	100
CM1.5SGN	100
CM1.5SO	100
CM1.5SYG	100
EPCM1.5S	50
CA509/K4WHT	100
SCM0.5/3	Blade size: 0.5 x 3 mm 10

Terminal Block	Grey	
	Blue	
	Red	
	Yellow	
	Black	
	Green	
	Orange	
	Yellow-Green	
End Plate		
Marking Tags (Refer Pg. 222 for details)		
Screw Driver		

CM1.5S2



8 x 26.5 mm

18 mm (Panel Mount)

IEC	UL - CSA
0.2 - 1.5 mm ²	24 - 16 AWG
0.2 - 2.5 mm ²	
0.2 - 1.5 mm ²	24 - 16 AWG
0.2 - 0.5 mm ²	24 - 20 AWG

8 mm

IEC60947-7-1	UL-1059	CSA22.2-158	IEC60079-7
500 V	300 V	300 V	320 V
17 A	10 A	10 A	15 A



Polyamide 6,6 / 1

6 KV / 3

CM2.5S



6 x 30 mm

20 mm (Panel Mount)

IEC	UL - CSA
0.34 - 2.5 mm ²	22 - 12 AWG
0.34 - 4.0 mm ²	
0.34 - 2.5 mm ²	22 - 12 AWG
0.34 - 1.5 mm ²	22 - 16 AWG

8 mm

IEC60947-7-1	UL-1059	CSA22.2-158	IEC60079-7
500 V	300 V	300 V	320 V
24 A	20 A	20 A	21 A



Polyamide 6,6 / 1

6 KV / 3

CM2.5S2



10 x 30 mm

20 mm (Panel Mount)

IEC	UL - CSA
0.34 - 2.5 mm ²	22 - 12 AWG
0.34 - 4.0 mm ²	
0.34 - 2.5 mm ²	22 - 12 AWG
0.34 - 1.5 mm ²	22 - 16 AWG

8 mm

IEC60947-7-1	UL-1059	CSA22.2-158	IEC60079-7
500 V	300 V	300 V	320 V
24 A	20 A	20 A	21 A



Polyamide 6,6 / 1

6 KV / 3

Type / Cat. No.	Standard Pack
CM1.5S2	100
CM1.5S2BU	100
CM1.5S2R	100
CM1.5S2Y	100
CM1.5S2BK	100
CM1.5S2GN	100
CM1.5S2O	100
CM1.5S2YG	100
EPCM1.5S	50
CA509/K7.5WHT	100
SCM0.5/3	Blade size: 0.5 x 3 mm 10

Type / Cat. No.	Standard Pack
CM2.5S	100
CM2.5SBU	100
CM2.5SR	100
CM2.5SY	100
CM2.5SBK	100
CM2.5SGN	100
CM2.5SO	100
CM2.5SYG	100
EPCM2.5S	50
CA509/K2WHT	100
SCM0.5/3	Blade size: 0.5 x 3 mm 10

Type / Cat. No.	Standard Pack
CM2.5S2	100
CM2.5S2BU	100
CM2.5S2R	100
CM2.5S2Y	100
CM2.5S2BK	100
CM2.5S2GN	100
CM2.5S2O	100
CM2.5S2YG	100
EPCM2.5S	50
CA509/K7.5WHT	100
SCM0.5/3	Blade size: 0.5 x 3 mm 10

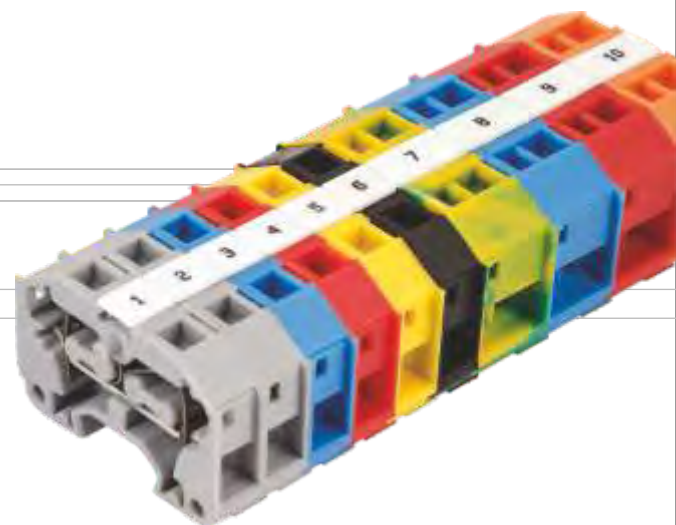

PANEL MOUNT TERMINAL BLOCKS

CM4S



CM4S2



Width (Thickness) x Length	7 x 33.7 mm	
Height	23 mm (Panel Mount)	
Connection Possibility as per	IEC	UL - CSA
With 1 Conductor per clamp	Stranded / Flexible	0.2 - 4.0 mm ²
	Solid	0.2 - 6.0 mm ²
	with Ferrule / Lug	0.2 - 4.0 mm ²
With 2 same size Conductors per clamp	with TWIN Ferrule / Lug	0.2 - 1.5 mm ²
Wire Stripping Length	10 mm	
Ratings As Per	IEC60947-7-1	UL-1059 CSA22.2-158
Voltage	630 V	300 V
Current	32 A	26 A
Approvals		
Insulation Material / Comparative Tracking Index	Polyamide 66 / 1	
Rated Impulse Voltage / Pollution Degree	6 KV / 3	

Width (Thickness) x Length	12 x 33.7 mm	
Height	23 mm (Panel Mount)	
Connection Possibility as per	IEC	UL - CSA
With 1 Conductor per clamp	Stranded / Flexible	0.2 - 4.0 mm ²
	Solid	0.2 - 6.0 mm ²
	with Ferrule / Lug	0.2 - 4.0 mm ²
With 2 same size Conductors per clamp	with TWIN Ferrule / Lug	0.2 - 1.5 mm ²
Wire Stripping Length	10 mm	
Ratings As Per	IEC60947-7-1	UL-1059 CSA22.2-158
Voltage	630 V	300 V
Current	32 A	26 A
Approvals		
Insulation Material / Comparative Tracking Index	Polyamide 66 / 1	
Rated Impulse Voltage / Pollution Degree	6 KV / 3	

Terminal Block	Grey	CM4S	100
	Blue	CM4SBU	100
	Red	CM4SR	100
	Yellow	CM4SY	100
	Black	CM4SBK	100
	Green	CM4SGN	100
	Orange	CM4SO	100
	Yellow-Green	CM4SYG	100
End Plate		EPCM4S	50
Marking Tags (Refer Pg. 222 for details)		CA509/K6WHT	100
Screw Driver		SCM0.6/3.5 Blade size: 0.6 x 3.5 mm	10
Actuator for actuating the Spring Clamp			
External Jumper			
End Clamp (Refer Pg. 218 for details)			
Mounting Rail (Refer Pg. 217 for details)			

Type / Cat. No.	Standard Pack	Type / Cat. No.	Standard Pack
CM4S	100	CM4S2	100
CM4SBU	100	CM4S2BU	100
CM4SR	100	CM4S2R	100
CM4SY	100	CM4S2Y	100
CM4SBK	100	CM4S2BK	100
CM4SGN	100	CM4S2GN	100
CM4SO	100	CM4S2O	100
CM4SYG	100	CM4S2YG	100
EPCM4S	50	EPCM4S	50
CA509/K6WHT	100	CA509/K12WHT	100
SCM0.6/3.5 Blade size: 0.6 x 3.5 mm	10	SCM0.6/3.5 Blade size: 0.6 x 3.5 mm	10

Type / Cat. No.	Standard Pack	Type / Cat. No.	Standard Pack
CM4S2	100	CM4S2	100
CM4S2BU	100	CM4S2BU	100
CM4S2R	100	CM4S2R	100
CM4S2Y	100	CM4S2Y	100
CM4S2BK	100	CM4S2BK	100
CM4S2GN	100	CM4S2GN	100
CM4S2O	100	CM4S2O	100
CM4S2YG	100	CM4S2YG	100
EPCM4S	50	EPCM4S	50
CA509/K12WHT	100	CA509/K12WHT	100
SCM0.6/3.5 Blade size: 0.6 x 3.5 mm	10	SCM0.6/3.5 Blade size: 0.6 x 3.5 mm	10

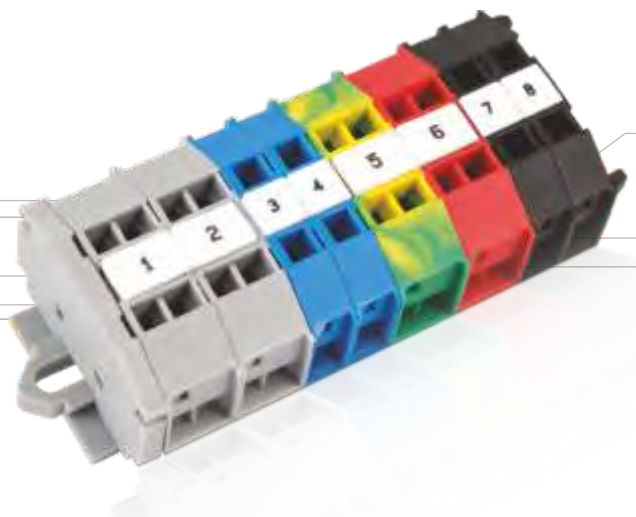

CSCP2.5T



5 x 35 mm

27.3 (Panel Mount)

IEC	UL - CSA
0.2 - 2.5 mm ²	22 - 14 AWG
0.2 - 4.0 mm ²	22 - 12 AWG
0.2 - 2.5 mm ²	22 - 14 AWG
0.2 - 1.5 mm ²	22 - 16 AWG

11 mm

IEC60947-7-1 UL-1059 CSA22.2-158 IEC 60079-7

800 V	600 V	600 V	500 V
24 A	20 A	20 A	21 A



Polyamide 6,6 / 1

8 KV / 3

CSCP2.5T2



10 x 35 mm

27.3 (Panel Mount)

IEC	UL - CSA
0.2 - 2.5 mm ²	22 - 14 AWG
0.2 - 4.0 mm ²	22 - 12 AWG
0.2 - 2.5 mm ²	22 - 14 AWG
0.2 - 1.5 mm ²	22 - 16 AWG

11 mm

IEC60947-7-1 UL-1059 CSA22.2-158 IEC 60079-7

800 V	600 V	600 V	500 V
24 A	20 A	20 A	21 A



Polyamide 6,6 / 1

8 KV / 3

CXCP2.5/4



10 x 38 mm

36.5 mm / 44 mm

IEC	UL - CSA
0.2 - 2.5 mm ²	22 - 14 AWG
0.2 - 4.0 mm ²	22 - 12 AWG
0.2 - 2.5 mm ²	22 - 14 AWG
0.2 - 1.5 mm ²	22 - 16 AWG

10 mm

IEC60947-7-1 UL-1059 CSA22.2-158

1000 V	600 V	600 V
24 A	20 A	20 A



Polyamide 66 / 1

8 KV / 3

Type / Cat. No.	Standard Pack
CSCP2.5T	100
CSCP2.5TBU	100
CSCP2.5TR	100
CSCP2.5TY	100
CSCP2.5TBK	100
CSCP2.5TGN	100
EPCSCP2.5T	50
CA509/K4WHT	100
SCM0.5/3 Blade size: 0.5 x 3 mm	10
SCA2.5	1
CA803/1 I _{max.} : 24 A	100

Type / Cat. No.	Standard Pack
CSCP2.5T2	50
CSCP2.5T2BU	50
CSCP2.5T2R	50
CSCP2.5T2Y	50
CSCP2.5T2BK	50
CSCP2.5T2GN	50
EPCSCP2.5T	50
CA509/K3WHT	100
SCM0.5/3 Blade size: 0.5 x 3 mm	10
SCA2.5	1

Type / Cat. No.	Standard Pack
CXCP2.5/4	50
EPCXCP2.5/4	50
CA509/K3WHT	100
SCM0.5/3 Blade size: 0.5 x 3 mm	10
SCA2.5	1
CA803/1 I _{max.} : 24 A	100
CA103 / CA104	50
CA701-1M / CA701-1M-S	50 m
CA701-15-1M / CA701-15-1M-S	25 m



CP SERIES PUSH-IN TERMINAL BLOCKS

CP series Push-In Terminal Blocks have a specialized connection system that enables tool less wire connections. Reliable, vibration resistant, gas tight connections are made with in built high quality stainless steel Push-In springclamps.

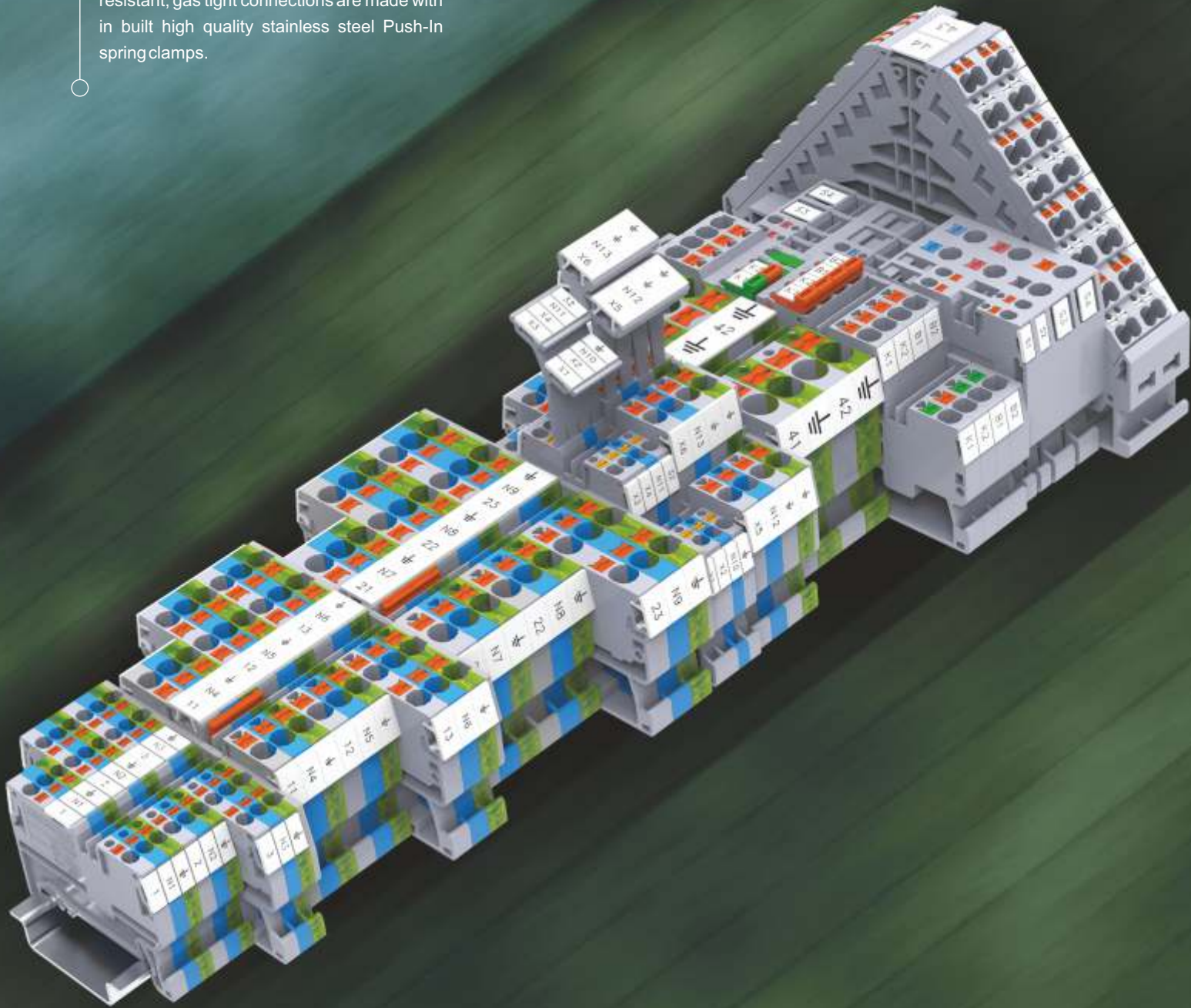

CP SERIES PUSH-IN TERMINAL BLOCKS



Feed Through

145 - 146



Multiple Connection

147 - 150



Ground / Earth

151 - 155



Double Level

156 - 159



Multiple Level

160 - 162



Disconnect

163 - 164

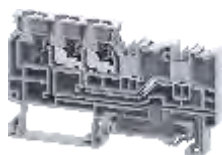

Sensor & Actuator

165 - 166



Marshalling

167 - 168

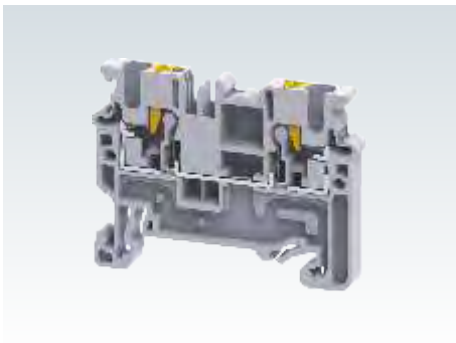

CP series Push-In Terminal Blocks have a specialized connection system that enables tool less wire connections. Reliable, vibration resistant, gas tight connections are made with in built high quality stainless steel Push-In spring clamps.



Solid wires and wires with crimped lugs / ferrules are simply pushed into the connection point. No special tools or screwdrivers are required for making such connections. The connection spring is actuated with minimum insertion force.



Standardized jumpers for shorting Terminal Blocks are now available in various pole configurations.



The possibility of using 2 independent rows for jumpering enables the creation of various circuit combinations. Jumpers can be marked with a felt tip pen on the recess provided on top, to clearly indicate shorted positions.

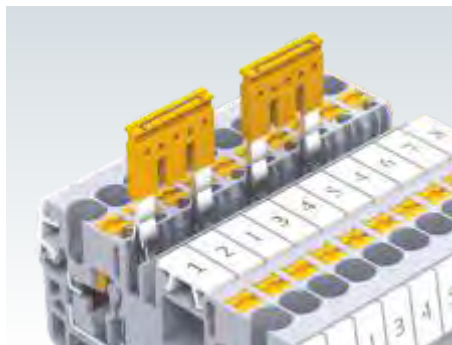

Individual Terminal Blocks in an assembly can be skipped from getting shorted with the adjacent terminal. This is achieved by breaking intermediate contacts from the standard pluggable jumpers.



Step down jumpers facilitate shorting of different wire size terminals. This helps in building distribution circuits easily.

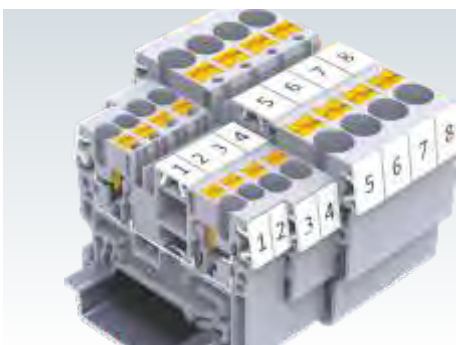

High quality stainless steel Push-In springs, provide a gas tight connection. A vibration proof, anti-loosening wire connection is achieved with this pre-stressed Push-In spring clamp system.



The jumper and marking tag position is aligned across different types of CP series Terminal Blocks. This facilitates shorting and marking adjacent terminals with different functionalities.



Ground Terminal Blocks have specially designed alloy feet which snap on to the DIN rail. They are green-yellow colour coded as per industry norms.

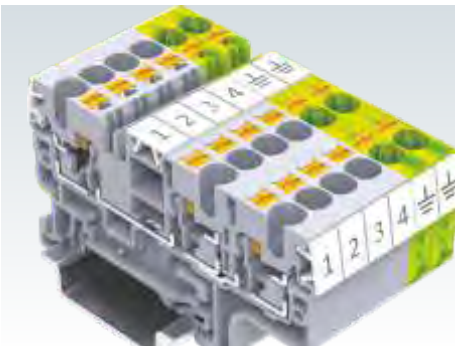

Multi connection Terminal Blocks are used for applications involving more than one same potential wires to be connected.

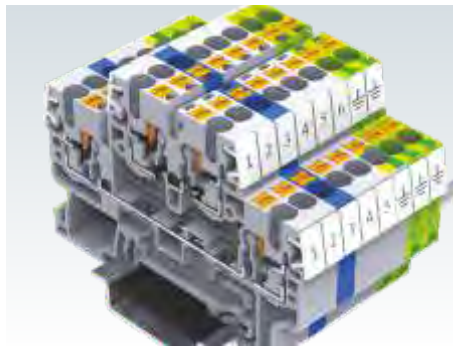

Double level Terminal Blocks enable high density wiring. Each level can be independently shorted to suit various applications.



Multi level Terminal Blocks are ideal choice for control systems. Two Level plus ground and three level plus ground terminals facilitate single & three phase connections.

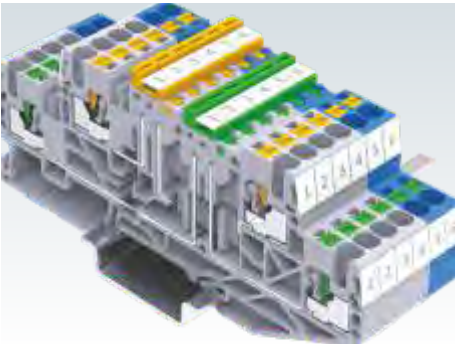

Knife type disconnecting Terminal Blocks are available for applications in process control industries. The circuit on individual levels can be easily disconnected by lifting the disconnection lever.

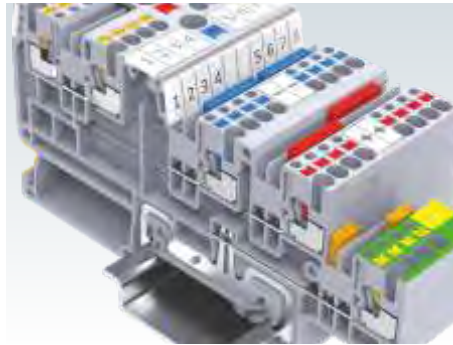

Sensors and actuator Terminal Blocks are ideal for wiring machine control systems. These Terminal Blocks are extremely compact with a terminal thickness of as low as 3.5mm



8 Level Terminal Blocks are space saving method for potential and signal distribution. Push-In connection technology facilitates extremely high density wiring. This is an ideal choice for high density marshalling cabinets.



Specially designed Test Plugs are available for CP series Terminal Blocks for quick testing and measurement.

FEED THROUGH TERMINAL BLOCKS

CP series Push-In Terminal Blocks have a specialized connection system that enables tool less wire connections.

Lugged cable & solid wires can be directly pressed into the clamp to make connections.

The Push button on the top is to be pressed for using flexible cable without lug / ferrule for connection.

Cross connection of these Terminal Blocks can be done using pluggable jumpers available in various pole configurations.

Width (Thickness) x Length		3.5 x 45.3 mm	
Height with DIN 35 x 7.5 / 35 x 15 mm Rail		32.8 mm / 40.3 mm	
Connection Possibility as per		IEC	UL - CSA
With 1 Conductor per clamp	Stranded / Flexible	0.2 - 1.5 mm ²	24 - 14 AWG
	Solid	0.2 - 2.5 mm ²	24 - 12 AWG
	with Ferrule / Lug	0.2 - 1.5 mm ²	24 - 16 AWG
With 2 same size Conductors per clamp	with TWIN Ferrule / Lug		
Wire Stripping Length		8 mm	
Ratings As Per		IEC60947-7-1	UL-1059
Voltage		800 V	600 V
Current		15 A	15 A
Approval		CE	
Insulation Material / Material Group		Polyamide 6,6 / 1	
Rated Impulse Voltage / Pollution Degree		8 KV / 3	

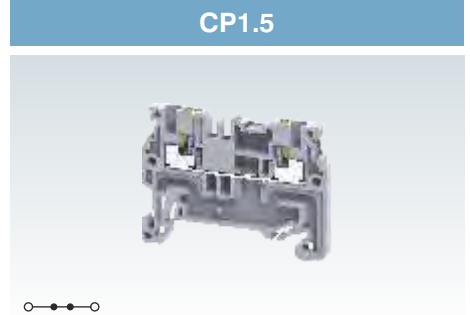

		Type / Cat. No.	Standard Pack
Terminal Block	Grey	CP1.5	100
	Blue	CP1.5BU	100
	Red	CP1.5R	100
	Yellow	CP1.5Y	100
	Black	CP1.5BK	100
	Green	CP1.5GN	100
	Orange	CP1.5O	100
	Ground / Earth	CPG1.5 (Refer Pg. 153 for details)	100
End Plate		EPCP1.5	50
Partition Plate		PPCX4	50
Mounting Rail (Refer Pg. 217 for details)		CA701-1M / CA701-1M-S CA701-15-1M / CA701-15-1M-S	50 m 25 m
End Clamp (Refer Pg. 218 for details)		CA103 / CA104	50
Marking Tags (Refer Pg. 222 for details)		MS3.5WHT	100
Screw Driver		SCM0.4/2.5 Blade size: 0.4 x 2.5 mm	10

Jumpers		Type / Cat. No.	I _{max}	Standard Pack
Pluggable Jumpers	2 pole	JX1.5/2	16 A	100
	3 pole	JX1.5/3	16 A	50
	4 pole	JX1.5/4	16 A	50
	5 pole			
	6 pole			
	7 pole			
	8 pole			
	10 pole	JX1.5/10	16 A	10
	16 pole			
	Step Down Jumpers	4 - 2.5 mm ² 6 - 2.5 mm ² 6 - 4 mm ²		
Test Plug				

CP2.5



5 x 49.7 mm

38.25 mm / 45.75 mm

IEC	UL - CSA
0.2 - 2.5 mm ²	24 - 12 AWG
0.2 - 4.0 mm ²	24 - 10 AWG
0.2 - 2.5 mm ²	24 - 12 AWG

0.5 mm² 22 AWG

10 mm

IEC60947-7-1 UL-1059

1000 V	600 V		
24 A	20 A		



Polyamide 6,6 / 1

8 KV / 3

CP4



6 x 54.8 mm

38.25 mm / 45.75 mm

IEC	UL - CSA
0.2 - 4.0 mm ²	24 - 10 AWG
0.2 - 6.0 mm ²	
0.2 - 4.0 mm ²	24 - 10 AWG

0.5 - 1.0 mm² 20 - 18 AWG

11 mm

IEC60947-7-1 UL-1059

1000 V	600 V		
32 A	30 A		



Polyamide 6,6 / 1

8 KV / 3

CP6/10



8 x 62.75 mm

43 mm / 50.55 mm

IEC	UL - CSA
0.5 - 10.0 mm ²	20 - 8 AWG
0.5 - 10.0 mm ²	20 - 8 AWG
0.5 - 10.0 mm ²	20 - 8 AWG

0.5 - 2.5 mm² 20 - 14 AWG

12 mm

IEC60947-7-1 UL-1059

1000 V	600 V		
57 A	44 A		



Polyamide 6,6 / 1

8 KV / 3

Type / Cat. No.	Standard Pack
CP2.5	100
CP2.5BU	100
CP2.5R	100
CP2.5Y	100
CP2.5BK	100
CP2.5GN	100
CP2.5O	100
CPG2.5 (Refer Pg. 154 for details)	100
EPCX2.5	50
PPCX4	50
CA701-1M / CA701-1M-S	50 m
CA701-15-1M / CA701-15-1M-S	25 m
CA103 / CA104	50
CA509/K5WHT	100
SCM0.5/3 Blade size: 0.5 x 3 mm	10

Type / Cat. No.	I _{max}	Standard Pack
JX2.5/2	24 A	100
JX2.5/3	24 A	50
JX2.5/4	24 A	50
JX2.5/5	24 A	50
JX2.5/6	24 A	10
JX2.5/7	24 A	10
JX2.5/8	24 A	10
JX2.5/10	24 A	10

TX2.5	20
-------	----

Type / Cat. No.	Standard Pack
CP4	100
CP4BU	100
CP4R	100
CP4Y	100
CP4BK	100
CP4GN	100
CP4O	100
CPG4 (Refer Pg. 154 for details)	100
EPCX4	50
PPCX4	50
CA701-1M / CA701-1M-S	50 m
CA701-15-1M / CA701-15-1M-S	25 m
CA103 / CA104	50
CA509/K6WHT	100
SCM0.5/3 Blade size: 0.5 x 3 mm	10

Type / Cat. No.	I _{max}	Standard Pack
JX4/2	32 A	100
JX4/3	32 A	50
JX4/4	32 A	50
JX4/8	32 A	10
JX4/10	32 A	10
JX4/16	32 A	10
JXS4/2.5	32 A	50

--	--	--

Type / Cat. No.	Standard Pack
CP6/10	100
CP6/10BU	100
CP6/10R	100
CP6/10Y	100
CP6/10BK	100
CP6/10GN	100
CP6/10O	100
CPG6/10 (Refer Pg. 154 for details)	100
EPCX6	50
PPCX10	20
CA701-1M / CA701-1M-S	50 m
CA701-15-1M / CA701-15-1M-S	25 m
CA103 / CA104	50
CA509/K8WHT	100
SCM0.8/4 Blade size: 0.8 x 4 mm	10

Type / Cat. No.	I _{max}	Standard Pack
JX6/2	41 A	100
JX6/3	41 A	50
JX6/4	41 A	50
JX6/10	41 A	10

JXS6/2.5	41 A	50
JXS6/4	41 A	50

MULTIPLE CONNECTION TERMINAL BLOCKS

CP series multi connect 3 wire & 4 wire Push-In type Terminal Blocks are used to eliminate reliability problems encountered when there is a need to connect multiple wires in a single Terminal Block.

CP1.5/3

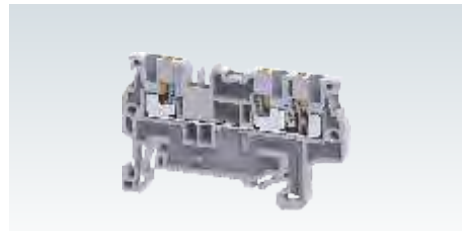

Width (Thickness) x Length	3.5 x 54.5 mm														
Height with DIN 35 x 7.5 / 35 x 15 mm Rail	32.8 mm / 40.3 mm														
Connection Possibility as per	<table border="1"> <thead> <tr> <th>IEC</th> <th colspan="2">UL - CSA</th> </tr> </thead> <tbody> <tr> <td>0.2 - 1.5 mm²</td> <td colspan="2">24 - 14 AWG</td> </tr> <tr> <td>0.2 - 2.5 mm²</td> <td colspan="2">24 - 12 AWG</td> </tr> <tr> <td>0.2 - 1.5 mm²</td> <td colspan="2">24 - 16 AWG</td> </tr> </tbody> </table>			IEC	UL - CSA		0.2 - 1.5 mm ²	24 - 14 AWG		0.2 - 2.5 mm ²	24 - 12 AWG		0.2 - 1.5 mm ²	24 - 16 AWG	
IEC	UL - CSA														
0.2 - 1.5 mm ²	24 - 14 AWG														
0.2 - 2.5 mm ²	24 - 12 AWG														
0.2 - 1.5 mm ²	24 - 16 AWG														
With 1 Conductor per clamp	Stranded / Flexible														
	Solid														
	with Ferrule / Lug														
With 2 same size Conductors per clamp	with TWIN Ferrule / Lug														
Wire Stripping Length	8 mm														
Ratings As Per	IEC60947-7-1	UL-1059													
Voltage	800 V	600 V													
Current	16 A	15 A													
Approval															
Insulation Material / Material Group	Polyamide 6,6 / 1														
Rated Impulse Voltage / Pollution Degree	8 KV / 3														

	Type / Cat. No.	Standard Pack	
Terminal Block	Grey	CP1.5/3	100
	Blue	CP1.5/3BU	100
	Red	CP1.5/3R	100
	Yellow	CP1.5/3Y	100
	Black	CP1.5/3BK	100
	Green	CP1.5/3GN	100
	Orange	CP1.5/3O	100
	Ground / Earth	CPG1.5/3 (Refer Pg. 155 for details)	100
End Plate	EPCP1.5/3	50	
Partition Plate	PPCX4/3	50	
Mounting Rail (Refer Pg. 217 for details)	CA701-1M / CA701-1M-S	50 m	
	CA701-15-1M / CA701-15-1M-S	25 m	
End Clamp (Refer Pg. 218 for details)	CA103 / CA104	50	
Marking Tags (Refer Pg. 222 for details)	MS3.5WHT	100	
Screw Driver	SCM0.4/2.5 Blade size: 0.4 x 2.5 mm	10	

	Type / Cat. No.	I _{max}	Standard Pack	
Jumpers	2 pole	JX1.5/2	16 A	100
	3 pole	JX1.5/3	16 A	50
	4 pole	JX1.5/4	16 A	50
	5 pole			
	6 pole			
	7 pole			
Pluggable Jumpers	8 pole			
	10 pole	JX1.5/10	16 A	10
Test Plug				

CP1.5/4



3.5 x 63.5 mm

32.8 mm / 40.3 mm

IEC	UL - CSA
0.2 - 1.5 mm ²	24 - 14 AWG
0.2 - 2.5 mm ²	24 - 12 AWG
0.2 - 1.5 mm ²	24 - 16 AWG

8 mm

IEC60947-7-1 UL-1059

800 V	600 V		
16 A	15 A		



Polyamide 6,6 / 1

8 KV / 3

CP2.5/3



5 x 62.5 mm

38.25 mm / 45.75 mm

IEC	UL - CSA
0.2 - 2.5 mm ²	24 - 12 AWG
0.2 - 4.0 mm ²	24 - 10 AWG
0.2 - 2.5 mm ²	24 - 12 AWG

0.5 mm²

22 AWG

10 mm

IEC60947-7-1 UL-1059

1000 V	600 V		
24 A	20 A		



Polyamide 6,6 / 1

8 KV / 3

CP2.5/4



5 x 73 mm

38.25 mm / 45.75 mm

IEC	UL - CSA
0.2 - 2.5 mm ²	24 - 12 AWG
0.2 - 4.0 mm ²	24 - 10 AWG
0.2 - 2.5 mm ²	24 - 12 AWG

0.5 mm²

22 AWG

10 mm

IEC60947-7-1 UL-1059

1000 V	600 V		
24 A	20 A		



Polyamide 6,6 / 1

8 KV / 3

Type / Cat. No.	Standard Pack
CP1.5/4	100
CP1.5/4BU	100
CP1.5/4R	100
CP1.5/4Y	100
CP1.5/4BK	100
CP1.5/4GN	100
CP1.5/4O	100
CPG1.5/4 (Refer Pg. 155 for details)	100
EPCP1.5/4	50
PPCX4/4	50
CA701-1M / CA701-1M-S	50 m
CA701-15-1M / CA701-15-1M-S	25 m
CA103 / CA104	50
MS3.5WHT	100
SCM0.4/2.5 Blade size: 0.4 x 2.5 mm	10

Type / Cat. No.	Standard Pack
CP2.5/3	100
CP2.5/3BU	100
CP2.5/3R	100
CP2.5/3Y	100
CP2.5/3BK	100
CP2.5/3GN	100
CP2.5/3O	100
CPG2.5/3 (Refer Pg. 156 for details)	100
EPCX2.5/3	50
PPCX4/3	50
CA701-1M / CA701-1M-S	50 m
CA701-15-1M / CA701-15-1M-S	25 m
CA103 / CA104	50
CA509/K5WHT	100
SCM0.5/3 Blade size: 0.5 x 3 mm	10

Type / Cat. No.	Standard Pack
CP2.5/4	100
CP2.5/4BU	100
CP2.5/4R	100
CP2.5/4Y	100
CP2.5/4BK	100
CP2.5/4GN	100
CP2.5/4O	100
CPG2.5/4 (Refer Pg. 156 for details)	100
EPCX2.5/4	50
PPCX4/4	50
CA701-1M / CA701-1M-S	50 m
CA701-15-1M / CA701-15-1M-S	25 m
CA103 / CA104	50
CA509/K5WHT	100
SCM0.5/3 Blade size: 0.5 x 3 mm	10

Type / Cat. No.	Imax	Standard Pack
JX1.5/2	16 A	100
JX1.5/3	16 A	50
JX1.5/4	16 A	50
JX1.5/10	16 A	10

Type / Cat. No.	Imax	Standard Pack
JX2.5/2	24 A	100
JX2.5/3	24 A	50
JX2.5/4	24 A	50
JX2.5/5	24 A	50
JX2.5/6	24 A	10
JX2.5/7	24 A	10
JX2.5/8	24 A	10
JX2.5/10	24 A	10
TX2.5		20

Type / Cat. No.	Imax	Standard Pack
JX2.5/2	24 A	100
JX2.5/3	24 A	50
JX2.5/4	24 A	50
JX2.5/5	24 A	50
JX2.5/6	24 A	10
JX2.5/7	24 A	10
JX2.5/8	24 A	10
JX2.5/10	24 A	10
TX2.5		20

CP4/3



CP4/4

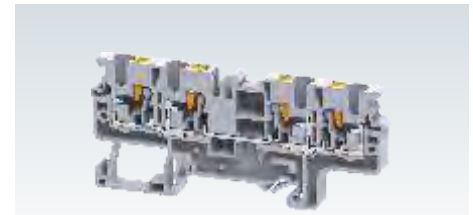

Width (Thickness) x Length	6 x 70.5 mm	
Height with DIN 35 x 7.5 / 35 x 15 mm Rail	38.25 mm / 45.75 mm	
Connection Possibility as per	IEC	UL - CSA
With 1 Conductor per clamp	Stranded / Flexible	0.2 - 4.0 mm ²
	Solid	0.2 - 6.0 mm ²
	with Ferrule / Lug	0.2 - 4.0 mm ²
With 2 same size Conductors per clamp	with TWIN Ferrule / Lug	0.5 - 1.0 mm ²
Wire Stripping Length	10 mm	
Ratings As Per	IEC60947-7-1	UL-1059
Voltage	1000 V	600 V
Current	32 A	30 A
Approval	CE	
Insulation Material / Material Group	Polyamide 6,6 / 1	
Rated Impulse Voltage / Pollution Degree	8 KV / 3	

Width (Thickness) x Length	6 x 70.5 mm	
Height with DIN 35 x 7.5 / 35 x 15 mm Rail	38.25 mm / 45.75 mm	
Connection Possibility as per	IEC	UL - CSA
With 1 Conductor per clamp	Stranded / Flexible	0.2 - 4.0 mm ²
	Solid	0.2 - 6.0 mm ²
	with Ferrule / Lug	0.2 - 4.0 mm ²
With 2 same size Conductors per clamp	with TWIN Ferrule / Lug	0.5 - 1.0 mm ²
Wire Stripping Length	10 mm	
Ratings As Per	IEC60947-7-1	UL-1059
Voltage	1000 V	600 V
Current	32 A	30 A
Approval	CE	
Insulation Material / Material Group	Polyamide 6,6 / 1	
Rated Impulse Voltage / Pollution Degree	8 KV / 3	

Width (Thickness) x Length	6 x 86.2 mm	
Height with DIN 35 x 7.5 / 35 x 15 mm Rail	38.25 mm / 45.75 mm	
Connection Possibility as per	IEC	UL - CSA
With 1 Conductor per clamp	Stranded / Flexible	0.2 - 4.0 mm ²
	Solid	0.2 - 6.0 mm ²
	with Ferrule / Lug	0.2 - 4.0 mm ²
With 2 same size Conductors per clamp	with TWIN Ferrule / Lug	0.5 - 1.0 mm ²
Wire Stripping Length	10 mm	
Ratings As Per	IEC60947-7-1	UL-1059
Voltage	1000 V	600 V
Current	32 A	30 A
Approval	CE	
Insulation Material / Material Group	Polyamide 6,6 / 1	
Rated Impulse Voltage / Pollution Degree	8 KV / 3	

	Type / Cat. No.	Standard Pack	
Terminal Block	Grey	CP4/3	50
	Blue	CP4/3BU	50
	Red	CP4/3R	50
	Yellow	CP4/3Y	50
	Black	CP4/3BK	50
	Green	CP4/3GN	50
	Orange	CP4/3O	50
	Ground / Earth	CPG4/3 (Refer Pg. 156 for details)	50
	End Plate	EPCX4/3	50
Partition Plate	PPCX4/3	50	
Mounting Rail (Refer Pg. 217 for details)	CA701-1M / CA701-1M-S	50 m	
	CA701-15-1M / CA701-15-1M-S	25 m	
End Clamp (Refer Pg. 218 for details)	CA103 / CA104	50	
Marking Tags (Refer Pg. 222 for details)	CA509/K6WHT	100	
Screw Driver	SCM0.5/3 Blade size: 0.5 x 3 mm	10	

	Type / Cat. No.	Standard Pack	
Terminal Block	Grey	CP4/4	50
	Blue	CP4/4BU	50
	Red	CP4/4R	50
	Yellow	CP4/4Y	50
	Black	CP4/4BK	50
	Green	CP4/4GN	50
	Orange	CP4/4O	50
	Ground / Earth	CPG4/4 (Refer Pg. 157 for details)	50
	End Plate	EPCX4/4	50
Partition Plate	PPCX4/4	50	
Mounting Rail (Refer Pg. 217 for details)	CA701-1M / CA701-1M-S	50 m	
	CA701-15-1M / CA701-15-1M-S	25 m	
End Clamp (Refer Pg. 218 for details)	CA103 / CA104	50	
Marking Tags (Refer Pg. 222 for details)	CA509/K6WHT	100	
Screw Driver	SCM0.5/3 Blade size: 0.5 x 3 mm	10	

	Type / Cat. No.	Standard Pack	
Terminal Block	Grey	CP4/4	50
	Blue	CP4/4BU	50
	Red	CP4/4R	50
	Yellow	CP4/4Y	50
	Black	CP4/4BK	50
	Green	CP4/4GN	50
	Orange	CP4/4O	50
	Ground / Earth	CPG4/4 (Refer Pg. 157 for details)	50
	End Plate	EPCX4/4	50
Partition Plate	PPCX4/4	50	
Mounting Rail (Refer Pg. 217 for details)	CA701-1M / CA701-1M-S	50 m	
	CA701-15-1M / CA701-15-1M-S	25 m	
End Clamp (Refer Pg. 218 for details)	CA103 / CA104	50	
Marking Tags (Refer Pg. 222 for details)	CA509/K6WHT	100	
Screw Driver	SCM0.5/3 Blade size: 0.5 x 3 mm	10	

	Type / Cat. No.	Imax	Standard Pack	
Pluggable Jumpers	2 pole	JX4/2	32 A	100
	3 pole	JX4/3	32 A	50
	4 pole	JX4/4	32 A	50
	5 pole			
	6 pole			
	7 pole			
	8 pole	JX4/8	32 A	10
	10 pole	JX4/10	32 A	10
	16 pole	JX4/16	32 A	10
	Step Down Jumpers	4 - 2.5 mm ²	JXS4/2.5	24 A
6 - 2.5 mm ²				
6 - 4 mm ²				

	Type / Cat. No.	Imax	Standard Pack	
Pluggable Jumpers	2 pole	JX4/2	32 A	100
	3 pole	JX4/3	32 A	50
	4 pole	JX4/4	32 A	50
	5 pole			
	6 pole			
	7 pole			
	8 pole	JX4/8	32 A	10
	10 pole	JX4/10	32 A	10
	16 pole	JX4/16	32 A	10
	Step Down Jumpers	4 - 2.5 mm ²	JXS4/2.5	24 A
6 - 2.5 mm ²				
6 - 4 mm ²				

	Type / Cat. No.	Imax	Standard Pack	
Pluggable Jumpers	2 pole	JX4/2	32 A	100
	3 pole	JX4/3	32 A	50
	4 pole	JX4/4	32 A	50
	5 pole			
	6 pole			
	7 pole			
	8 pole	JX4/8	32 A	10
	10 pole	JX4/10	32 A	10
	16 pole	JX4/16	32 A	10
	Step Down Jumpers	4 - 2.5 mm ²	JXS4/2.5	24 A
6 - 2.5 mm ²				
6 - 4 mm ²				

CP6/10/3



8 x 82.85 mm

43 mm / 50.55 mm

IEC	UL - CSA
0.5 - 10.0 mm ²	20 - 8 AWG
0.5 - 10.0 mm ²	20 - 8 AWG
0.5 - 2.5 mm ²	20 - 14 AWG

12 mm

IEC60947-7-1 UL-1059

1000 V	600 V		
57 A	44 A		



Polyamide 6,6 / 1

8 KV / 3

Type / Cat. No.	Standard Pack
CP6/10/3	50
CP6/10/3BU	50
CP6/10/3R	50
CP6/10/3Y	50
CP6/10/3BK	50
CP6/10/3GN	50
CP6/10/3O	50
CPG6/10/3 (Refer Pg. 157 for details)	50
EPCX6/3	50

CA701-1M / CA701-1M-S	50 m
CA701-15-1M / CA701-15-1M-S	25 m
CA103 / CA104	50
CA509/K8WHT	100
SCM0.8/4 Blade size: 0.8 x 4 mm	10

Type / Cat. No.	I _{max}	Standard Pack
JX6/2	41 A	100
JX6/3	41 A	50
JX6/4	41 A	50

JX6/10	41 A	10
--------	------	----







JXS6/2.5	24 A	50
JXS6/4	32 A	50

GROUND / EARTH TERMINAL BLOCKS

CPG series are compact Push-In type earthing Terminal Blocks with specially designed alloy feet which help in achieving very low contact resistance and vibration proof grounding with the DIN rails. They are Green-Yellow colour coded as per industry standards.

Cross connection of these Terminal Blocks can be done using insulated pluggable jumpers.

Multi connect 3 wire & 4 wire terminals eliminate reliability problems encountered when there is a need to connect multiple wires in a single Terminal Block.

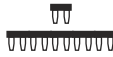
Width (Thickness) x Length		3.5 x 45.3 mm	
Height with DIN 35 x 7.5 / 35 x 15 mm Rail		32.8 mm / 40.3 mm	
Connection Possibility as per		IEC	UL - CSA
With 1 Conductor per clamp	Stranded / Flexible	0.2 - 1.5 mm ²	26 - 14 AWG
	Solid with Ferrule / Lug	0.2 - 2.5 mm ²	26 - 12 AWG
With 2 same size Conductors per clamp	with TWIN Ferrule / Lug	0.2 - 1.5 mm ²	26 - 16 AWG
Wire Stripping Length		8 mm	
Approval			
Insulation Material / Material Group		Polyamide 6,6 / 1	
Rated Impulse Voltage / Pollution Degree		8 KV / 3	
		Type / Cat. No.	Standard Pack
Terminal Block		CPG1.5	100
End Plate 		EPCP1.5	50
Partition Plate 		PPCX4	50
Mounting Rail (Refer Pg. 217 for details) 		CA701-1M / CA701-1M-S	50 m
End Clamp (Refer Pg. 218 for details) 		CA701-15-1M / CA701-15-1M-S	25 m
Marking Tags (Refer Pg. 222 for details) 		CA103 / CA104	50
Screw Driver 		MS3.5	100
		SCM0.4/2.5 Blade size: 0.4 x 2.5 mm	10
Jumpers		Type / Cat. No.	I_{max}
Pluggable Jumpers 	2 pole	JX1.5/2	16 A
	3 pole	JX1.5/3	16 A
	4 pole	JX1.5/4	16 A
	5 pole		
	6 pole		
	7 pole		
	8 pole		
	10 pole	JX1.5/10	16 A
	10 pole		
	10 pole		
Step Down Jumpers			
4 - 2.5 mm ²			
6 - 2.5 mm ²			
6 - 4 mm ²			
Test Plug			

CPG1.5

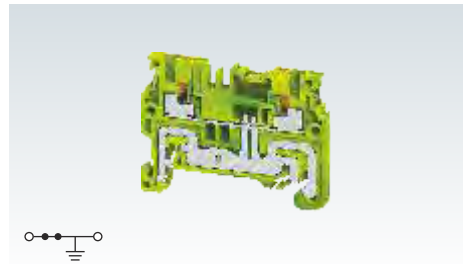

CPG2.5

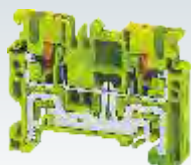

5 x 49.7 mm
38.25 mm / 45.75 mm

IEC	UL - CSA
0.2 - 2.5 mm ²	24 - 12 AWG
0.2 - 4.0 mm ²	24 - 10 AWG
0.2 - 2.5 mm ²	24 - 12 AWG

0.5 mm² 22 AWG

10 mm



Polyamide 6,6 / 1

8 KV / 3

Type / Cat. No.	Standard Pack
CPG2.5	100
EPCX2.5	50
PPCX4	50
CA701-1M / CA701-1M-S	50 m
CA701-15-1M / CA701-15-1M-S	25 m
CA103 / CA104	50
CA509/K5WHT	100
SCM0.5/3 Blade size: 0.5 x 3 mm	10

Type / Cat. No.	I _{max}	Standard Pack
JX2.5/2	24 A	100
JX2.5/3	24 A	50
JX2.5/4	24 A	50
JX2.5/5	24 A	50
JX2.5/6	24 A	10
JX2.5/7	24 A	10
JX2.5/8	24 A	10
JX2.5/10	24 A	10

TX2.5 20

CPG4



6 x 54.8 mm
38.25 mm / 45.75 mm

IEC	UL - CSA
0.2 - 4.0 mm ²	24 - 10 AWG
0.2 - 6.0 mm ²	
0.2 - 4.0 mm ²	24 - 10 AWG

0.5 - 1.0 mm² 20 - 18 AWG

11 mm



Polyamide 6,6 / 1

8 KV / 3

Type / Cat. No.	Standard Pack
CPG4	100
EPCX4	50
PPCX4	50
CA701-1M / CA701-1M-S	50 m
CA701-15-1M / CA701-15-1M-S	25 m
CA103 / CA104	50
CA509/K6WHT	100
SCM0.5/3 Blade size: 0.5 x 3 mm	10

Type / Cat. No.	I _{max}	Standard Pack
JX4/2	32 A	100
JX4/3	32 A	50
JX4/4	32 A	50
JX4/8	32 A	10
JX4/10	32 A	10
JXS4/2.5	24 A	50

CPG6/10



8 x 62.75 mm
43 mm / 50.55 mm

IEC	UL - CSA
0.5 - 10.0 mm ²	20 - 8 AWG
0.5 - 10.0 mm ²	20 - 8 AWG

0.5 - 2.5 mm² 20 - 14 AWG

12 mm



Polyamide 6,6 / 1

8 KV / 3

Type / Cat. No.	Standard Pack
CPG6/10	100
EPCX6	50
PPCX10	20
CA701-1M / CA701-1M-S	50 m
CA701-15-1M / CA701-15-1M-S	25 m
CA103 / CA104	50
CA509/K8WHT	100
SCM0.8/4 Blade size: 0.8 x 4 mm	10

Type / Cat. No.	I _{max}	Standard Pack
JX6/2	41 A	100
JX6/3	41 A	50
JX6/4	41 A	50
JX6/10	41 A	10

JXS6/2.5	24 A	50
JXS6/4	32 A	50

CPG1.5/3

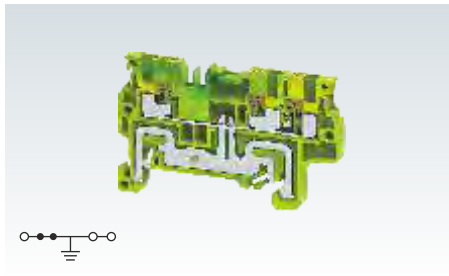

CPG1.5/4

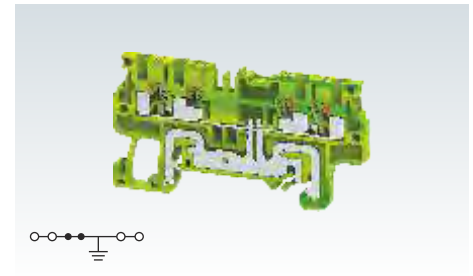

Width (Thickness) x Length	
Height with DIN 35 x 7.5 / 35 x 15 mm Rail	
Connection Possibility as per	
With 1 Conductor per clamp	Stranded / Flexible
	Solid with Ferrule / Lug
With 2 same size Conductors per clamp	with TWIN Ferrule / Lug
Wire Stripping Length	

3.5 x 54.5 mm	
32.8 mm / 40.3 mm	
IEC	UL - CSA
0.2 - 1.5 mm ²	26 - 14 AWG
0.2 - 2.5 mm ²	26 - 12 AWG
0.2 - 1.5 mm ²	26 - 16 AWG
8 mm	

3.5 x 63.5 mm	
32.8 mm / 40.3 mm	
IEC	UL - CSA
0.2 - 1.5 mm ²	26 - 14 AWG
0.2 - 2.5 mm ²	26 - 12 AWG
0.2 - 1.5 mm ²	26 - 16 AWG
8 mm	

Approval	
Insulation Material / Material Group	
Rated Impulse Voltage / Pollution Degree	

CE	
Polyamide 6,6 / 1	
8 KV / 3	

CE	
Polyamide 6,6 / 1	
8 KV / 3	

Terminal Block	CPG1.5/3	100
End Plate	EPCP1.5/3	50
Partition Plate	PPCX4/3	50
Mounting Rail (Refer Pg. 217 for details)	CA701-1M / CA701-1M-S	50 m
	CA701-15-1M / CA701-15-1M-S	25 m
End Clamp (Refer Pg. 218 for details)	CA103 / CA104	50
Marking Tags (Refer Pg. 222 for details)	MS3.5WHT	100
Screw Driver	SCM0.4/2.5 Blade size: 0.4 x 2.5 mm	10

Type / Cat. No.	Standard Pack
CPG1.5/3	100
EPCP1.5/3	50
PPCX4/3	50
CA701-1M / CA701-1M-S	50 m
CA701-15-1M / CA701-15-1M-S	25 m
CA103 / CA104	50
MS3.5WHT	100
SCM0.4/2.5 Blade size: 0.4 x 2.5 mm	10

Type / Cat. No.	Standard Pack
CPG1.5/4	100
EPCP1.5/4	50
PPCX4/4	50
CA701-1M / CA701-1M-S	50 m
CA701-15-1M / CA701-15-1M-S	25 m
CA103 / CA104	50
MS3.5WHT	100
SCM0.4/2.5 Blade size: 0.4 x 2.5 mm	10

Jumpers		
Pluggable Jumpers	2 pole	
	3 pole	
	4 pole	
	5 pole	
	6 pole	
	7 pole	
	8 pole	
	10 pole	
	Step Down Jumpers	4 - 2.5 mm ²
	Test Plug	

Type / Cat. No.	I _{max}	Standard Pack
JX1.5/2	16 A	100
JX1.5/3	16 A	50
JX1.5/4	16 A	50
JX1.5/10	16 A	10

Type / Cat. No.	I _{max}	Standard Pack
JX1.5/2	16 A	100
JX1.5/3	16 A	50
JX1.5/4	16 A	50
JX1.5/10	16 A	10

CPG2.5/3

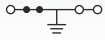

5 x 62.5 mm
38.25 mm / 45.75 mm

IEC	UL - CSA
0.2 - 2.5 mm ²	24 - 12 AWG
0.2 - 4.0 mm ²	24 - 10 AWG
0.2 - 2.5 mm ²	24 - 12 AWG

0.5 mm² 22 AWG

10 mm



Polyamide 6,6 / 1

8 KV / 3

Type / Cat. No.	Standard Pack
CPG2.5/3	100
EPCX2.5/3	50
PPCX4/3	50
CA701-1M / CA701-1M-S	50 m
CA701-15-1M / CA701-15-1M-S	25 m
CA103 / CA104	50
CA509/K5WHT	100
SCM0.5/3 Blade size: 0.5 x 3 mm	10

Type / Cat. No.	I _{max}	Standard Pack
JX2.5/2	24 A	100
JX2.5/3	24 A	50
JX2.5/4	24 A	50
JX2.5/5	24 A	50
JX2.5/6	24 A	10
JX2.5/7	24 A	10
JX2.5/8	24 A	10
JX2.5/10	24 A	10

TX2.5 20

CPG2.5/4

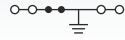
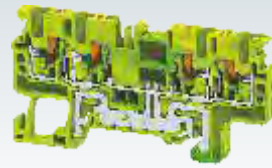

5 x 73 mm
38.25 mm / 45.75 mm

IEC	UL - CSA
0.2 - 2.5 mm ²	24 - 12 AWG
0.2 - 4.0 mm ²	24 - 10 AWG
0.2 - 2.5 mm ²	24 - 12 AWG

0.5 mm² 22 AWG

10 mm



Polyamide 6,6 / 1

8 KV / 3

Type / Cat. No.	Standard Pack
CPG2.5/4	100
EPCX2.5/4	50
PPCX4/4	50
CA701-1M / CA701-1M-S	50 m
CA701-15-1M / CA701-15-1M-S	25 m
CA103 / CA104	50
CA509/K5WHT	100
SCM0.5/3 Blade size: 0.5 x 3 mm	10

Type / Cat. No.	I _{max}	Standard Pack
JX2.5/2	24 A	100
JX2.5/3	24 A	50
JX2.5/4	24 A	50
JX2.5/5	24 A	50
JX2.5/6	24 A	10
JX2.5/7	24 A	10
JX2.5/8	24 A	10
JX2.5/10	24 A	10

TX2.5 20

CPG4/3

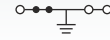

6 x 70.5 mm
38.25 mm / 45.75 mm

IEC	UL - CSA
0.2 - 4.0 mm ²	24 - 10 AWG
0.2 - 6.0 mm ²	
0.2 - 4.0 mm ²	24 - 10 AWG

0.5 - 1.0 mm² 20 - 18 AWG

10 mm



Polyamide 6,6 / 1

8 KV / 3

Type / Cat. No.	Standard Pack
CPG4/3	50
EPCX4/3	50
PPCX4/3	50
CA701-1M / CA701-1M-S	50 m
CA701-15-1M / CA701-15-1M-S	25 m
CA103 / CA104	50
CA509/K6WHT	100
SCM0.5/3 Blade size: 0.5 x 3 mm	10

Type / Cat. No.	I _{max}	Standard Pack
JX4/2	32 A	100
JX4/3	32 A	50
JX4/4	32 A	50
JX4/8	32 A	10
JX4/10	32 A	10
JXS4/2.5		50

CPG4/4

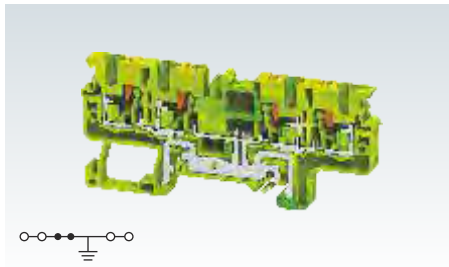

CPG6/10/3

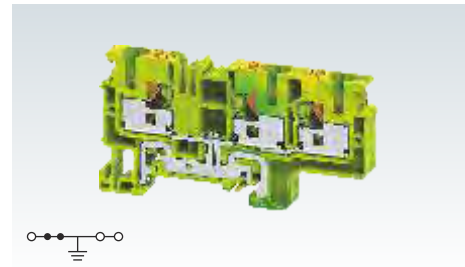

Width (Thickness) x Length	
Height with DIN 35 x 7.5 / 35 x 15 mm Rail	
Connection Possibility as per	
With 1 Conductor per clamp	Stranded / Flexible
	Solid
With 2 same size Conductors per clamp	with Ferrule / Lug
	with TWIN Ferrule / Lug
Wire Stripping Length	

6 x 86.2 mm			
38.25 mm / 45.75 mm			
IEC		UL - CSA	
0.2 - 4.0 mm ²	24 - 10 AWG		
	24 - 10 AWG		
0.2 - 6.0 mm ²	24 - 10 AWG		
0.2 - 4.0 mm ²	24 - 10 AWG		
0.5 - 1.0 mm ²	20 - 18 AWG		
10 mm			

8 x 82.85 mm			
43 mm / 50.55 mm			
IEC		UL - CSA	
0.5 - 10.0 mm ²	20 - 8 AWG		
	20 - 8 AWG		
0.5 - 10.0 mm ²	20 - 8 AWG		
0.5 - 2.5 mm ²	20 - 14 AWG		
12 mm			

Approval	CE
Insulation Material / Material Group	Polyamide 6,6 / 1
Rated Impulse Voltage / Pollution Degree	8 KV / 3

CE	
Polyamide 6,6 / 1	
8 KV / 3	

CE	
Polyamide 6,6 / 1	
8 KV / 3	

Terminal Block	
End Plate	
Partition Plate	
Mounting Rail	(Refer Pg. 217 for details)
End Clamp	(Refer Pg. 218 for details)
Marking Tags	(Refer Pg. 222 for details)
Screw Driver	

Type / Cat. No.	Standard Pack
CPG4/4	50
EPCX4/4	50
PPCX4/4	50
CA701-1M / CA701-1M-S	50 m
CA701-15-1M / CA701-15-1M-S	25 m
CA103 / CA104	50
CA509/K6WHT	100
SCM0.5/3 Blade size: 0.5 x 3 mm	10

Type / Cat. No.	Standard Pack
CPG6/10/3	50
EPCX6/3	50
CA701-1M / CA701-1M-S	50 m
CA701-15-1M / CA701-15-1M-S	25 m
CA103 / CA104	50
CA509/K8WHT	100
SCM0.8/4 Blade size: 0.8 x 4 mm	10

Jumpers	
Pluggable Jumpers	2 pole
	3 pole
	4 pole
	5 pole
	6 pole
	7 pole
	8 pole
	10 pole
	4 - 2.5 mm ²
	6 - 2.5 mm ²
6 - 4 mm ²	

Type / Cat. No.	I _{max}	Standard Pack
JX4/2	32 A	100
JX4/3	32 A	50
JX4/4	32 A	50
JX4/8	32 A	10
JX4/10	32 A	10
JXS4/2.5	24 A	50

Type / Cat. No.	I _{max}	Standard Pack
JX6/2	41 A	100
JX6/3	41 A	50
JX6/4	41 A	50
JX6/10	41 A	10
JXS6/2.5	24 A	50
JXS6/4	32 A	50

DOUBLE LEVEL TERMINAL BLOCKS

CPDL1.5 & CPDL2.5 are compact double level Push-In type Terminal Block. These Terminal Blocks are used in high density wiring applications. Interconnections / jumpering is possible at both levels.

CPDL1.5(I.S) & CPDL2.5(I.S) are double level internally shorted Terminal Blocks. These are ideal choice for distribution application.

CPDLG1.5 & CPDLG2.5 are double level Push-In Terminal Blocks with an additional grounding point for terminating grounding cables on the lower level of the terminal block. The earth connection is made by snapping the terminal on the Din rail. This separate connection point is appropriately identified by the green-yellow imprint on its top.

CPDLG1.5(I.S) & CPDLG2.5(I.S) are double level ground Terminal Blocks with 4 connection points for grounding wires. It is available in a standard green-yellow colour to indicate the grounding connection.

CPDL1.5

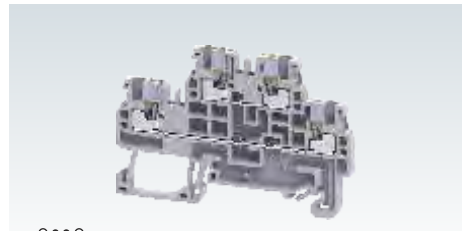

Width (Thickness) x Length	3.5 x 67.2 mm		
Height with DIN 35 x 7.5 / 35 x 15 mm Rail	45.3 mm / 52.8 mm		
Connection Possibility as per	IEC	UL - CSA	
With 1 Conductor per clamp	Stranded / Flexible	0.2 - 1.5 mm ²	24 - 14 AWG
	Solid	0.2 - 2.5 mm ²	24 - 12 AWG
	with Ferrule / Lug	0.2 - 1.5 mm ²	24 - 16 AWG
With 2 same size Conductors per clamp	with TWIN Ferrule / Lug		
Wire Stripping Length	8 mm		
Ratings As Per	IEC60947-7-1	UL-1059	
Voltage	500 V	300 V	
Current	16 A	15 A	
Approval			
Insulation Material / Material Group	Polyamide 6,6 / 1		
Rated Impulse Voltage / Pollution Degree	8 KV / 3		

		Type / Cat. No.	Standard Pack
Terminal Block	Grey	CPDL1.5	100
	Blue	CPDL1.5BU	100
	Red	CPDL1.5R	100
	Yellow	CPDL1.5Y	100
	Black	CPDL1.5BK	100
	Green	CPDL1.5GN	100
	Orange	CPDL1.5O	100
	Ground / Earth	CPDLG1.5 (Refer Pg. 159 for details)	100
	End Plate	EPCPDL1.5	50
Mounting Rail (Refer Pg. 217 for details)	CA701-1M / CA701-1M-S	50 m	
	CA701-15-1M / CA701-15-1M-S	25 m	
End Clamp (Refer Pg. 218 for details)	CA103 / CA104	50	
Marking Tags (Refer Pg. 222 for details)	MS3.5WHT	100	
Tree Marker	TM3.5	50	
Screw Driver	SCM0.4/2.5 Blade size: 0.4 x 2.5 mm	10	

		Type / Cat. No.	I _{max}	Standard Pack
Pluggable Jumpers	2 pole	JX1.5/2	16 A	100
	3 pole	JX1.5/3	16 A	50
	4 pole	JX1.5/4	16 A	50
	5 pole			
	6 pole			
	7 pole			
	8 pole			
	10 pole	JX1.5/10	16 A	10

DOUBLE LEVEL TERMINAL BLOCKS

CPDL1.5(I.S)

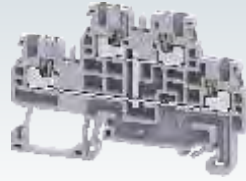

CPDLG1.5



Width (Thickness) x Length	3.5 x 67.2 mm		3.5 x 67.2 mm		
Height with DIN 35 x 7.5 / 35 x 15 mm Rail	45.3 mm / 52.8 mm		45.3 mm / 52.8 mm		
Connection Possibility as per	IEC	UL - CSA		IEC	UL - CSA
		With 1 Conductor per clamp	Stranded / Flexible		
		Solid	24 - 12 AWG	0.2 - 2.5 mm ²	24 - 12 AWG
		with Ferrule / Lug	24 - 16 AWG	0.2 - 1.5 mm ²	24 - 16 AWG
With 2 same size Conductors per clamp		with TWIN Ferrule / Lug			
Wire Stripping Length	8 mm		8 mm		
Ratings As Per	IEC60947-7-1 UL-1059		IEC60947-7-1 UL-1059		
Voltage	500 V	300 V		500 V	300 V
	Current	16 A	15 A	16 A	15 A
Approval	CE		CE		
Insulation Material / Material Group	Polyamide 6,6 / 1		Polyamide 6,6 / 1		
Rated Impulse Voltage / Pollution Degree	8 KV / 3		8 KV / 3		

		Type / Cat. No.	Standard Pack	Type / Cat. No.	Standard Pack			
Terminal Block	Grey	CPDL1.5(I.S)	100	CPDLG1.5	100			
	Blue							
	Red							
	Yellow							
	Black							
	Green							
	Orange							
	Ground / Earth							
End Plate		EPCPDL1.5	50	EPCPDL1.5	50			
Mounting Rail (Refer Pg. 217 for details)		CA701-1M / CA701-1M-S	50 m	CA701-1M / CA701-1M-S	50 m			
		CA701-15-1M / CA701-15-1M-S	25 m	CA701-15-1M / CA701-15-1M-S	25 m			
End Clamp (Refer Pg. 218 for details)		CA103 / CA104	50	CA103 / CA104	50			
Marking Tags (Refer Pg. 222 for details)		MS3.5WHT	100	MS3.5WHT	100			
Dual Marker Carrier		TM3.5	50	TM3.5	50			
Screw Driver		SCM0.4/2.5 Blade size: 0.4 x 2.5 mm	10	SCM0.4/2.5 Blade size: 0.4 x 2.5 mm	10			
Jumpers		Type / Cat. No.	Imax	Standard Pack	Type / Cat. No.	Imax	Standard Pack	
	Pluggable Jumpers		JX1.5/2	16 A	100	JX1.5/2	16 A	100
			JX1.5/3	16 A	50	JX1.5/3	16 A	50
			JX1.5/4	16 A	50	JX1.5/4	16 A	50
	JX1.5/10	16 A	10	JX1.5/10	16 A	10		
Test Plug								

CPDLG1.5(I.S)

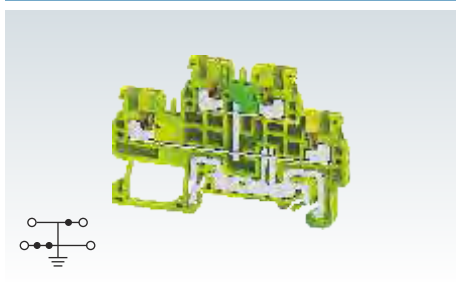

3.5 x 67.2 mm

45.3 mm / 52.8 mm

IEC	UL - CSA
0.2 - 1.5 mm ²	24 - 14 AWG
0.2 - 2.5 mm ²	24 - 12 AWG
0.2 - 1.5 mm ²	24 - 16 AWG

8 mm



Polyamide 6,6 / 1

8 KV / 3

Type / Cat. No.	Standard Pack
CPDLG1.5(I.S)	100

EPCPDL1.5	50
CA701-1M / CA701-1M-S	50 m
CA701-15-1M / CA701-15-1M-S	25 m
CA103 / CA104	50
MS3.5WHT	100
TM3.5	50
SCM0.4/2.5 Blade size: 0.4 x 2.5 mm	10

Type / Cat. No.	I _{max}	Standard Pack
JX1.5/2	16 A	100
JX1.5/3	16 A	50
JX1.5/4	16 A	50
JX1.5/10	16 A	10

CPDL2.5

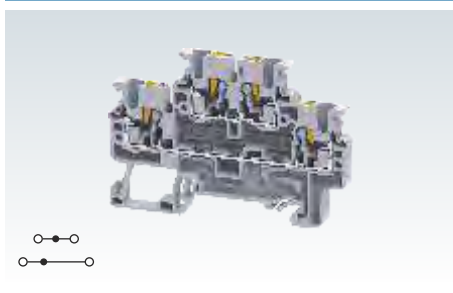

5 x 72.7 mm

49.55 mm / 57 mm

IEC	UL - CSA
0.2 - 2.5 mm ²	24 - 12 AWG
0.2 - 4.0 mm ²	24 - 10 AWG
0.2 - 2.5 mm ²	24 - 12 AWG

0.5 mm²

22 AWG

10 mm

IEC60947-7-1 UL-1059

1000 V

600 V

24 A

20 A



Polyamide 6,6 / 1

8 KV / 3

Type / Cat. No.	Standard Pack
CPDL2.5	50
CPDL2.5BU	50
CPDL2.5R	50
CPDL2.5Y	50
CPDL2.5BK	50
CPDL2.5GN	50
CPDL2.5O	50
CPDLG2.5(I.S.) (Refer Pg. 161 for details)	50

EPCXDL2.5	50
CA701-1M / CA701-1M-S	50 m
CA701-15-1M / CA701-15-1M-S	25 m
CA103 / CA104	50
CA509/K5WHT	100
TM5	50
SCM0.5/3 Blade size: 0.5 x 3 mm	10

Type / Cat. No.	I _{max}	Standard Pack
JX2.5/2	24 A	100
JX2.5/3	24 A	50
JX2.5/4	24 A	50
JX2.5/5	24 A	50
JX2.5/6	24 A	10
JX2.5/7	24 A	10
JX2.5/8	24 A	10
JX2.5/10	24 A	10
TX2.5		20

CPDL2.5(I.S)

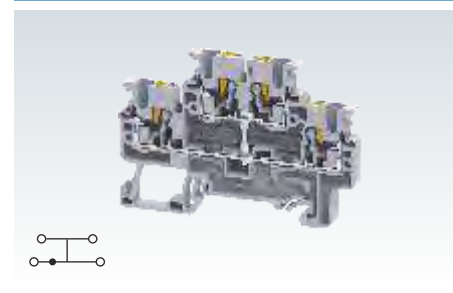

5 x 72.7 mm

49.55 mm / 57 mm

IEC	UL - CSA
0.2 - 2.5 mm ²	24 - 12 AWG
0.2 - 4.0 mm ²	24 - 10 AWG
0.2 - 2.5 mm ²	24 - 12 AWG

0.5 mm²

22 AWG

10 mm

IEC60947-7-1 UL-1059

1000 V

600 V

24 A

20 A



Polyamide 6,6 / 1

8 KV / 3

Type / Cat. No.	Standard Pack
CPDL2.5(I.S)	50

EPCXDL2.5	50
CA701-1M / CA701-1M-S	50 m
CA701-15-1M / CA701-15-1M-S	25 m
CA103 / CA104	50
CA509/K5WHT	100
TM5	50
SCM0.5/3 Blade size: 0.5 x 3 mm	10

Type / Cat. No.	I _{max}	Standard Pack
JX2.5/2	24 A	100
JX2.5/3	24 A	50
JX2.5/4	24 A	50
JX2.5/5	24 A	50
JX2.5/6	24 A	10
JX2.5/7	24 A	10
JX2.5/8	24 A	10
JX2.5/10	24 A	10
TX2.5		20

CPDLG2.5

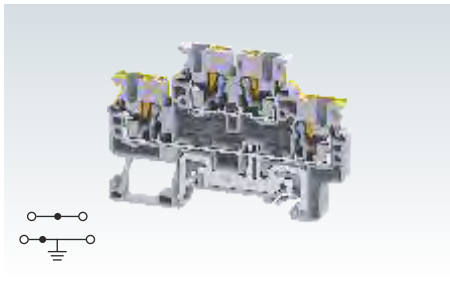

CPDLG2.5(I.S)

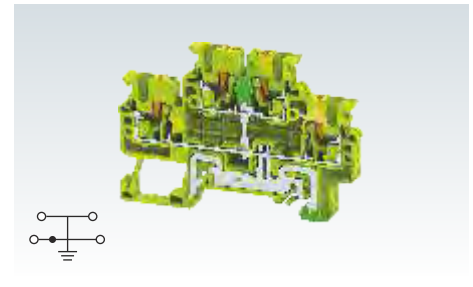

Width (Thickness) x Length		5 x 72.7 mm	
Height with DIN 35 x 7.5 / 35 x 15 mm Rail		49.55 mm / 57 mm	
Connection Possibility as per		IEC	UL - CSA
With 1 Conductor per clamp	Stranded / Flexible	0.2 - 2.5 mm ²	24 - 12 AWG
	Solid	0.2 - 4.0 mm ²	24 - 10 AWG
	with Ferrule / Lug	0.2 - 2.5 mm ²	24 - 12 AWG
With 2 same size Conductors per clamp	with TWIN Ferrule / Lug	0.5 mm ²	22 AWG
Wire Stripping Length		10 mm	
Ratings As Per		IEC60947-7-1 UL-1059	
Voltage		1000 V	600 V
Current		24 A	20 A
Approval		CE	
Insulation Material / Material Group		Polyamide 6,6 / 1	
Rated Impulse Voltage / Pollution Degree		8 KV / 3	

Width (Thickness) x Length		5 x 72.7 mm	
Height with DIN 35 x 7.5 / 35 x 15 mm Rail		49.55 mm / 57 mm	
Connection Possibility as per		IEC	UL - CSA
With 1 Conductor per clamp	Stranded / Flexible	0.2 - 2.5 mm ²	24 - 12 AWG
	Solid	0.2 - 4.0 mm ²	24 - 10 AWG
	with Ferrule / Lug	0.2 - 2.5 mm ²	24 - 12 AWG
With 2 same size Conductors per clamp	with TWIN Ferrule / Lug	0.5 mm ²	22 AWG
Wire Stripping Length		10 mm	
Ratings As Per		IEC60947-7-1 UL-1059	
Voltage		1000 V	600 V
Current		24 A	20 A
Approval		CE	
Insulation Material / Material Group		Polyamide 6,6 / 1	
Rated Impulse Voltage / Pollution Degree		8 KV / 3	

Width (Thickness) x Length		5 x 72.7 mm	
Height with DIN 35 x 7.5 / 35 x 15 mm Rail		49.55 mm / 57 mm	
Connection Possibility as per		IEC	UL - CSA
With 1 Conductor per clamp	Stranded / Flexible	0.2 - 2.5 mm ²	24 - 12 AWG
	Solid	0.2 - 4.0 mm ²	24 - 10 AWG
	with Ferrule / Lug	0.2 - 2.5 mm ²	24 - 12 AWG
With 2 same size Conductors per clamp	with TWIN Ferrule / Lug	0.5 mm ²	22 AWG
Wire Stripping Length		10 mm	
Ratings As Per		IEC60947-7-1 UL-1059	
Voltage		1000 V	600 V
Current		24 A	20 A
Approval		CE	
Insulation Material / Material Group		Polyamide 6,6 / 1	
Rated Impulse Voltage / Pollution Degree		8 KV / 3	

Terminal Block	Grey Blue Red Yellow Black Green Orange Ground / Earth	Type / Cat. No.	Standard Pack
End Plate		EPCXDL2.5	50
Mounting Rail (Refer Pg. 217 for details)		CA701-1M / CA701-1M-S CA701-15-1M / CA701-15-1M-S	50 m 25 m
End Clamp (Refer Pg. 218 for details)		CA103 / CA104	50
Marking Tags (Refer Pg. 222 for details)		CA509/K5WHT	100
Tree Marker		TM5	50
Screw Driver		SCM0.5/3 Blade size: 0.5 x 3 mm	10

Terminal Block	Grey Blue Red Yellow Black Green Orange Ground / Earth	Type / Cat. No.	Standard Pack
End Plate		EPCXDL2.5	50
Mounting Rail (Refer Pg. 217 for details)		CA701-1M / CA701-1M-S CA701-15-1M / CA701-15-1M-S	50 m 25 m
End Clamp (Refer Pg. 218 for details)		CA103 / CA104	50
Marking Tags (Refer Pg. 222 for details)		CA509/K5WHT	100
Tree Marker		TM5	50
Screw Driver		SCM0.5/3 Blade size: 0.5 x 3 mm	10

Terminal Block	Grey Blue Red Yellow Black Green Orange Ground / Earth	Type / Cat. No.	Standard Pack
End Plate		EPCXDL2.5	50
Mounting Rail (Refer Pg. 217 for details)		CA701-1M / CA701-1M-S CA701-15-1M / CA701-15-1M-S	50 m 25 m
End Clamp (Refer Pg. 218 for details)		CA103 / CA104	50
Marking Tags (Refer Pg. 222 for details)		CA509/K5WHT	100
Tree Marker		TM5	50
Screw Driver		SCM0.5/3 Blade size: 0.5 x 3 mm	10

Pluggable Jumpers		2 pole	JX2.5/2	24 A	100	
		3 pole	JX2.5/3	24 A	50	
		4 pole	JX2.5/4	24 A	50	
		5 pole	JX2.5/5	24 A	50	
		6 pole	JX2.5/6	24 A	10	
		7 pole	JX2.5/7	24 A	10	
		8 pole	JX2.5/8	24 A	10	
		10 pole	JX2.5/10	24 A	10	
		Test Plug		TX2.5		20

Pluggable Jumpers		2 pole	JX2.5/2	24 A	100	
		3 pole	JX2.5/3	24 A	50	
		4 pole	JX2.5/4	24 A	50	
		5 pole	JX2.5/5	24 A	50	
		6 pole	JX2.5/6	24 A	10	
		7 pole	JX2.5/7	24 A	10	
		8 pole	JX2.5/8	24 A	10	
		10 pole	JX2.5/10	24 A	10	
		Test Plug		TX2.5		20

Pluggable Jumpers		2 pole	JX2.5/2	24 A	100	
		3 pole	JX2.5/3	24 A	50	
		4 pole	JX2.5/4	24 A	50	
		5 pole	JX2.5/5	24 A	50	
		6 pole	JX2.5/6	24 A	10	
		7 pole	JX2.5/7	24 A	10	
		8 pole	JX2.5/8	24 A	10	
		10 pole	JX2.5/10	24 A	10	
		Test Plug		TX2.5		20

MULTIPLE LEVEL TERMINAL BLOCKS

CP3L2.5 is three level feed through Terminal Block. This is a practical solution for creating high density wiring circuits.

CP3L2.5(I.S) is a three level internally shorted version and is an ideal choice for distribution circuits.

CP3LG2.5 has 2 levels of feed through function with a grounding feet on the third level.

In CP3LG2.5(I.S) all three levels are internally shorted to the ground contact.

CP4LG2.5 is 3 level feed through Terminal Block with a grounding feet on the fourth level. This is suitable for three phase wire connection applications.

CP3L2.5

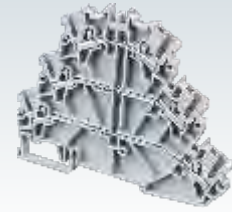

Width (Thickness) x Length	5 x 98.70 mm		
Height with DIN 35 x 7.5 / 35 x 15 mm Rail	83.10 mm / 90.60 mm		
Connection Possibility as per	IEC	UL - CSA	
With 1 Conductor per clamp	Stranded / Flexible	0.34 - 2.5 mm ²	22 - 12 AWG
	Solid	0.34 - 4.0 mm ²	22 - 10 AWG
	with Ferrule / Lug	0.34 - 2.5 mm ²	22 - 12 AWG
With 2 same size Conductors per clamp	with TWIN Ferrule / Lug	0.34 - 0.5 mm ²	22 - 20 AWG
Wire Stripping Length	10 mm		
Ratings As Per	IEC60947-7-1	UL-1059	
Voltage	500 V	300 V	
Current	24 A	20 A	
Approvals			
Insulation Material / Comparative Tracking Index	Polyamide 6,6 / 1		
Rated Impulse Voltage / Pollution Degree	6 KV / 3		

	Type / Cat. No.	Standard Pack
Terminal Block	CP3L2.5	30
End Plate	EPCP3L2.5	30
Mounting Rail (Refer Pg. 217 for details)	CA701-1M / CA701-1M-S	50 m
	CA701-15-1M / CA701-15-1M-S	25 m
End Clamp (Refer Pg. 218 for details)	CA202 / CA103	50
Marking Tags (Refer Pg. 222 for details)	CA509/K2GWHT	100
Screw Driver	SCM0.5/3 Blade size: 0.5 x 3 mm	10

	Type / Cat. No.	I _{max}	Standard Pack
Pluggable Jumpers	2 pole	24 A	100
	3 pole	24 A	100
	4 pole	24 A	100
	10 pole	24 A	10



CP3L2.5(I.S)

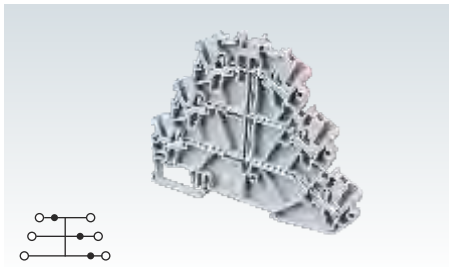

CP3LG2.5

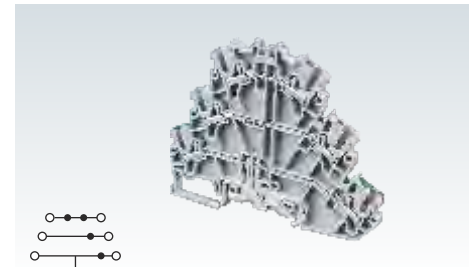

Width (Thickness) x Length	5 x 98.70 mm	
Height with DIN 35 x 7.5 / 35 x 15 mm Rail	83.10 mm / 90.60 mm	
Connection Possibility as per	IEC	UL - CSA
With 1 Conductor per clamp	Stranded / Flexible	0.34 - 2.5 mm ²
	Solid	0.34 - 4.0 mm ²
	with Ferrule / Lug	0.34 - 2.5 mm ²
With 2 same size Conductors per clamp	with TWIN Ferrule / Lug	0.34 - 0.5 mm ²
Wire Stripping Length	10 mm	
Ratings As Per	IEC60947-7-1	UL-1059
Voltage	500 V	300 V
Current	24 A	20 A
Approvals	CE	
Insulation Material / Comparative Tracking Index	Polyamide 6,6 / 1	
Rated Impulse Voltage / Pollution Degree	6 KV / 3	

Width (Thickness) x Length	5 x 98.70 mm	
Height with DIN 35 x 7.5 / 35 x 15 mm Rail	83.10 mm / 90.60 mm	
Connection Possibility as per	IEC	UL - CSA
With 1 Conductor per clamp	Stranded / Flexible	0.34 - 2.5 mm ²
	Solid	0.34 - 4.0 mm ²
	with Ferrule / Lug	0.34 - 2.5 mm ²
With 2 same size Conductors per clamp	with TWIN Ferrule / Lug	0.34 - 0.5 mm ²
Wire Stripping Length	10 mm	
Ratings As Per	IEC60947-7-1	UL-1059
Voltage	500 V	300 V
Current	24 A	20 A
Approvals	CE	
Insulation Material / Comparative Tracking Index	Polyamide 6,6 / 1	
Rated Impulse Voltage / Pollution Degree	6 KV / 3	

Width (Thickness) x Length	5 x 98.70 mm	
Height with DIN 35 x 7.5 / 35 x 15 mm Rail	83.10 mm / 90.60 mm	
Connection Possibility as per	IEC	UL - CSA
With 1 Conductor per clamp	Stranded / Flexible	0.34 - 2.5 mm ²
	Solid	0.34 - 4.0 mm ²
	with Ferrule / Lug	0.34 - 2.5 mm ²
With 2 same size Conductors per clamp	with TWIN Ferrule / Lug	0.34 - 0.5 mm ²
Wire Stripping Length	10 mm	
Ratings As Per	IEC60947-7-1	UL-1059
Voltage	500 V	300 V
Current	24 A	20 A
Approvals	CE	
Insulation Material / Comparative Tracking Index	Polyamide 6,6 / 1	
Rated Impulse Voltage / Pollution Degree	6 KV / 3	

Terminal Block	
End Plate	
Mounting Rail (Refer Pg. 217 for details)	
End Clamp (Refer Pg. 218 for details)	
Marking Tags (Refer Pg. 222 for details)	
Screw Driver	

Type / Cat. No.	Standard Pack
CP3L2.5(I.S)	30
EPCP3L2.5	30
CA701-1M / CA701-1M-S	50 m
CA701-15-1M / CA701-15-1M-S	25 m
CA202 / CA103	50
CA509/K2GWHT	100
SCM0.5/3 Blade size: 0.5 x 3 mm	10

Type / Cat. No.	Standard Pack
CP3LG2.5	30
EPCP3L2.5	30
CA701-1M / CA701-1M-S	50 m
CA701-15-1M / CA701-15-1M-S	25 m
CA202 / CA103	50
CA509/K2GWHT	100
SCM0.5/3 Blade size: 0.5 x 3 mm	10

Jumpers	Type / Cat. No.	I _{max}	Standard Pack
Pluggable Jumpers	2 pole	24 A	100
	3 pole	24 A	100
	4 pole	24 A	100
	10 pole	24 A	10

Type / Cat. No.	I _{max}	Standard Pack
CA801/A2	24 A	100
CA801/A3	24 A	100
CA801/A4	24 A	100
CA801/A10	24 A	10

Type / Cat. No.	I _{max}	Standard Pack
CA801/A2	24 A	100
CA801/A3	24 A	100
CA801/A4	24 A	100
CA801/A10	24 A	10

CP3LG2.5(I.S)

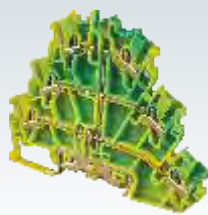
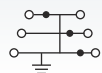

5 x 98.70 mm

83.10 mm / 90.60 mm

IEC	UL - CSA
0.34 - 2.5 mm ²	22 - 12 AWG
0.34 - 4.0 mm ²	22 - 10 AWG
0.34 - 2.5 mm ²	22 - 12 AWG

0.34 - 0.5 mm² 22 - 20 AWG

10 mm



Polyamide 6,6 / 1

6 KV / 3

Type / Cat. No.	Standard Pack
CP3LG2.5(I.S)	30
EPCP3L2.5	30
CA701-1M / CA701-1M-S	50 m
CA701-15-1M / CA701-15-1M-S	25 m
CA202 / CA103	50
CA509/K2GWHT	100
SCM0.5/3 Blade size: 0.5 x 3 mm	10

Type / Cat. No.	I _{max}	Standard Pack
CA801/A2	24 A	100
CA801/A3	24 A	100
CA801/A4	24 A	100
CA801/A10	24 A	10

CP4LG2.5

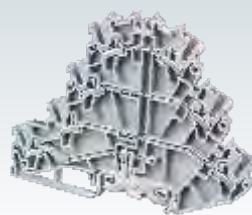

5 x 118.6 mm

93 mm / 100.50 mm

IEC	UL - CSA
0.34 - 2.5 mm ²	22 - 12 AWG
0.34 - 4.0 mm ²	22 - 10 AWG
0.34 - 2.5 mm ²	22 - 12 AWG

0.34 - 0.5 mm² 22 - 20 AWG

10 mm

IEC60947-7-1 UL-1059

500 V

300 V

24 A

20 A



Polyamide 6,6 / 1

6 KV / 3

Type / Cat. No.	Standard Pack
CP4LG2.5	30
EPCP4LG2.5	30
CA701-1M / CA701-1M-S	50 m
CA701-15-1M / CA701-15-1M-S	25 m
CA202 / CA103	50
CA509/K2GWHT	100
SCM0.5/3 Blade size: 0.5 x 3 mm	10

Type / Cat. No.	I _{max}	Standard Pack
CA801/A2	24 A	100
CA801/A3	24 A	100
CA801/A4	24 A	100
CA801/A10	24 A	10

DISCONNECTING TERMINAL BLOCKS

CPDLK series terminals are double level disconnect Terminal Blocks.

In these Terminal Blocks disconnection is achieved by opening the insulated knife (blade) contact. The disconnecting knife is appropriately colour coded to ensure error free disconnection of the correct circuit.

CPDLK2.5 Terminal Blocks offer disconnection separately for both top and bottom levels.

CPDLK2.5(I.S) Terminal Block is internally shorted, offering single potential for all 4 connection points.

CPDLKFT2.5 is double level Terminal Block with a disconnecting lever on the top level and a feed through system on the bottom level.

CPDLKFT2.5(I.S) offer similar configuration with top and bottom level internally shorted.

Alternate and continuous bridging can be done with standard pluggable jumpers.

CPDLK2.5



Width (Thickness) x Length	5 x 107.25 mm		
Height with DIN 35 x 7.5 / 35 x 15 mm Rail	50 mm / 57.5 mm		
Connection Possibility as per	IEC	UL - CSA	
With 1 Conductor per clamp	Stranded / Flexible	0.2 - 2.5 mm ²	24 - 12 AWG
	Solid	0.2 - 4.0 mm ²	24 - 10 AWG
	with Ferrule / Lug	0.2 - 2.5 mm ²	24 - 12 AWG
With 2 same size Conductors per clamp	with TWIN Ferrule / Lug	0.5 mm ²	22 AWG
Wire Stripping Length	10 mm		
Ratings As Per	IEC60947-7-1	UL-1059	
Voltage	500 V	300 V	
Current	16 A	14 A	
Approval	CE		
Insulation Material / Material Group	Polyamide 6,6 / 1		
Rated Impulse Voltage / Pollution Degree	6 KV / 3		

		Type / Cat. No.	Standard Pack	
Terminal Block	Grey	CPDLK2.5	50	
End Plate		EPCPDLK2.5	50	
Mounting Rail (Refer Pg. 217 for details)		CA701-1M / CA701-1M-S	50 m	
End Clamp (Refer Pg. 218 for details)		CA701-15-1M / CA701-15-1M-S	25 m	
End Clamp		CA103 / CA104	50	
Marking Tags (Refer Pg. 222 for details)		MS5WHT	100	
Marking Tags For Knife Contact		CA509/K4WHT	100	
Screw Driver		SCM0.5/3 Blade size: 0.5 x 3 mm	10	
Jumpers		Type / Cat. No.	I _{max}	Standard Pack
	2 pole	JX2.5/2	24 A	100
	3 pole	JX2.5/3	24 A	50
	4 pole	JX2.5/4	24 A	50
	5 pole	JX2.5/5	24 A	50
Pluggable Jumpers	6 pole	JX2.5/6	24 A	10
	7 pole	JX2.5/7	24 A	10
	8 pole	JX2.5/8	24 A	10
	10 pole	JX2.5/10	24 A	10

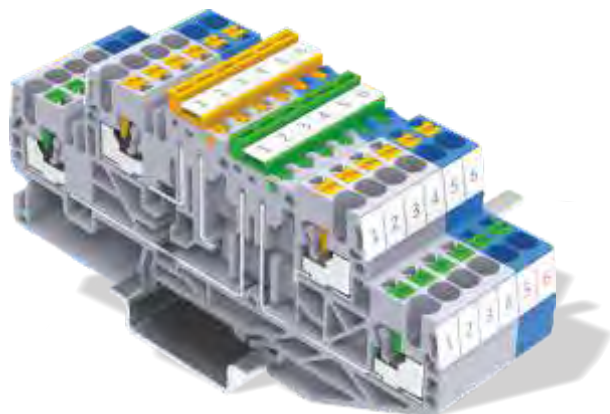

CPDLK2.5(I.S)

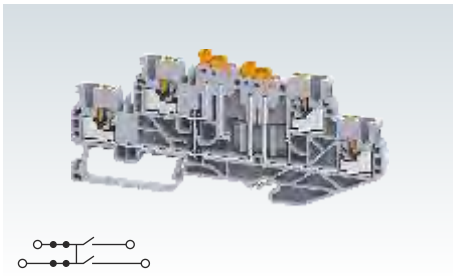

5 x 107.25 mm
50 mm / 57.5 mm

IEC	UL - CSA
0.2 - 2.5 mm ²	24 - 12 AWG
0.2 - 4.0 mm ²	24 - 10 AWG
0.2 - 2.5 mm ²	24 - 12 AWG

0.5 mm² 22 AWG

10 mm

IEC60947-7-1 UL-1059

500 V	300 V		
16 A	14 A		



Polyamide 6,6 / 1

6 KV / 3

CPDLKFT2.5

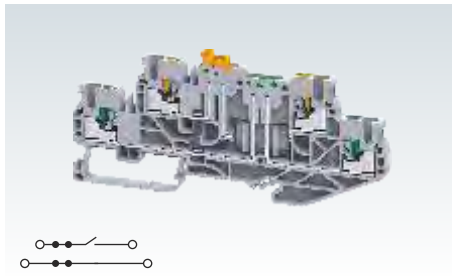

5 x 107.25 mm
50 mm / 57.5 mm

IEC	UL - CSA
0.2 - 2.5 mm ²	24 - 12 AWG
0.2 - 4.0 mm ²	24 - 10 AWG
0.2 - 2.5 mm ²	24 - 12 AWG

0.5 mm² 22 AWG

10 mm

IEC60947-7-1 UL-1059

500 V	300 V		
16 A	14 A		



Polyamide 6,6 / 1

6 KV / 3

CPDLKFT2.5(I.S)

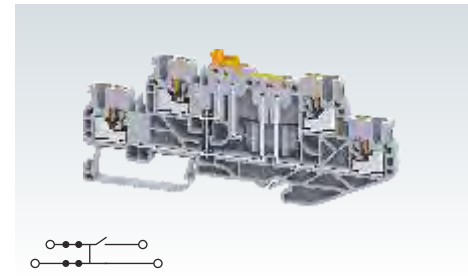

5 x 107.25 mm
50 mm / 57.5 mm

IEC	UL - CSA
0.2 - 2.5 mm ²	24 - 12 AWG
0.2 - 4.0 mm ²	24 - 10 AWG
0.2 - 2.5 mm ²	24 - 12 AWG

0.5 mm² 22 AWG

10 mm

IEC60947-7-1 UL-1059

500 V	300 V		
16 A	14 A		



Polyamide 6,6 / 1

6 KV / 3

Type / Cat. No.	Standard Pack
CPDLK2.5(I.S)	50
EPCPDLK2.5	50
CA701-1M / CA701-1M-S	50 m
CA701-15-1M / CA701-15-1M-S	25 m
CA103 / CA104	50
MS5WHT	100
CA509/K4WHT	100
SCM0.5/3 Blade size: 0.5 x 3 mm	10

Type / Cat. No.	Standard Pack
CPDLKFT2.5	50
EPCPDLK2.5	50
CA701-1M / CA701-1M-S	50 m
CA701-15-1M / CA701-15-1M-S	25 m
CA103 / CA104	50
MS5WHT	100
CA509/K4WHT	100
SCM0.5/3 Blade size: 0.5 x 3 mm	10

Type / Cat. No.	Standard Pack
CPDLKFT2.5(I.S)	50
EPCPDLK2.5	50
CA701-1M / CA701-1M-S	50 m
CA701-15-1M / CA701-15-1M-S	25 m
CA103 / CA104	50
MS5WHT	100
CA509/K4WHT	100
SCM0.5/3 Blade size: 0.5 x 3 mm	10

Type / Cat. No.	I _{max}	Standard Pack
JX2.5/2	24 A	100
JX2.5/3	24 A	50
JX2.5/4	24 A	50
JX2.5/5	24 A	50
JX2.5/6	24 A	10
JX2.5/7	24 A	10
JX2.5/8	24 A	10
JX2.5/10	24 A	10

Type / Cat. No.	I _{max}	Standard Pack
JX2.5/2	24 A	100
JX2.5/3	24 A	50
JX2.5/4	24 A	50
JX2.5/5	24 A	50
JX2.5/6	24 A	10
JX2.5/7	24 A	10
JX2.5/8	24 A	10
JX2.5/10	24 A	10

Type / Cat. No.	I _{max}	Standard Pack
JX2.5/2	24 A	100
JX2.5/3	24 A	50
JX2.5/4	24 A	50
JX2.5/5	24 A	50
JX2.5/6	24 A	10
JX2.5/7	24 A	10
JX2.5/8	24 A	10
JX2.5/10	24 A	10

SENSOR & ACTUATOR TERMINAL BLOCKS

Sensors and actuator Terminal Blocks are ideal for wiring modern machine control systems. These Terminal Blocks are extremely compact with a terminal thickness of 3.5 mm.

CPST1.5/3 is a 3 wire sensor Terminal Block. These terminals can be bridged together with a power feed through terminal CPPT2.5/3 by using standard pluggable jumpers.

CPST1.5/4 is a 4 wire sensor Terminal Block which can be used in conjunction with CPPTG2.5/4 power feed through terminal.

In CPSTG1.5/4 an additional grounding point is available and is colour coded green yellow for clear identification.

CPPT2.5/3 is used to bring in the power connection for 3 wire sensor terminals CPST1.5/3.

CPPTG2.5/4 is used for 4 wire sensor terminals CPST1.5/4 & CPSTG1.5/4.

Blue & Red colour jumpers are available for clear circuit identification.

CPST1.5/3



Width (Thickness) x Length	3.5 x 79.8 mm		
Height with DIN 35 x 7.5 / 35 x 15	48.1 mm / 55.55 mm		
Connection Possibility as per	IEC	UL - CSA	
With 1 Conductor per clamp	Stranded / Flexible	0.2 - 1.5 mm ²	24 - 14 AWG
	Solid	0.2 - 2.5 mm ²	24 - 12 AWG
	with Ferrule / Lug	0.2 - 1.5 mm ²	24 - 16 AWG
With 2 same size Conductors per clamp	with TWIN Ferrule / Lug		
Wire Stripping Length	8 mm		
Ratings As Per	IEC60947-1	UL-1059	
Voltage	250 V	150 V	
Current	13.5 A	15 A	
Approvals	CE		
Insulation Material / Material Group	Polyamide 6,6 / 1		
Rated Impulse Voltage / Pollution Degree	4 KV / 3		

		Type / Cat. No.	Standard Pack
Terminal Block	_____	CPST1.5/3	50
	_____ With LED Indication	CPST1.5/3L*	50
	_____ With Grounding Point		
_____ With Grounding Point & LED Indication			
End Plate	For 3 wire Sensor Terminal Block For 4 wire Sensor Terminal Block	EPCPPT2.5/3	50
Mounting Rail	(Refer Pg. 217 for details)	CA701-1M / CA701-1M-S CA701-15-1M / CA701-15-1M-S	50 m 25 m
End Clamp	(Refer Pg. 218 for details)	CA103 / CA104 / CA802	50
Marking Tags	(Refer Pg. 222 for details)	MS3.5WHT	100
Screw Driver		SCM0.4/2.5 Blade size: 0.4 x 2.5 mm	10

Jumpers		Orange Jumper	Blue Jumper	Red Jumper	I _{max}	Std. Pack
Pluggable Jumpers	2 pole	JX1.5/2	JX1.5/2BU	JX1.5/2R	16 A	100
	3 pole	JX1.5/3	JX1.5/3BU	JX1.5/3R	16 A	100
	4 pole	JX1.5/4	JX1.5/4BU	JX1.5/4R	16 A	100
	10 pole	JX1.5/10	JX1.5/10BU	JX1.5/10R	16 A	10

* Standard voltage range for LED indication of 6-60 V & 110-240 V available.

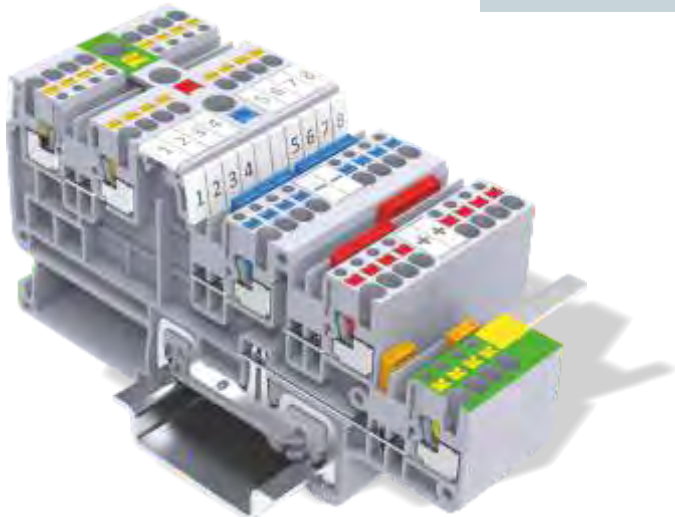

CPST1.5/4

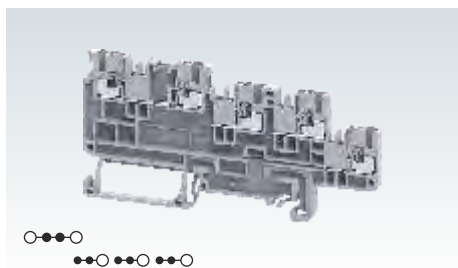

3.5 x 96.5 mm

48.1 mm / 55.55 mm

IEC	UL - CSA
0.2 - 1.5 mm ²	24 - 14 AWG
0.2 - 2.5 mm ²	24 - 12 AWG
0.2 - 1.5 mm ²	24 - 16 AWG

8 mm

IEC60947-7-1 UL-1059

250 V	150 V		
13.5 A	15 A		



Polyamide 6,6 / 1

4 KV / 3

Type / Cat. No.	Standard Pack
CPST1.5/4	50
CPST1.5/4L*	50
EPCPPT2.5/4	50
CA701-1M / CA701-1M-S	50 m
CA701-15-1M / CA701-15-1M-S	25 m
CA103 / CA104 / CA802	50
MS3.5WHT	100
SCM0.4/2.5 Blade size: 0.4 x 2.5 mm	10

Orange Jumper	Blue Jumper	Red Jumper	I _{max}	Std. Pack
JX1.5/2	JX1.5/2BU	JX1.5/2R	16 A	100
JX1.5/3	JX1.5/3BU	JX1.5/3R	16 A	100
JX1.5/4	JX1.5/4BU	JX1.5/4R	16 A	100
JX1.5/10	JX1.5/10BU	JX1.5/10R	16 A	10

CPSTG1.5/4

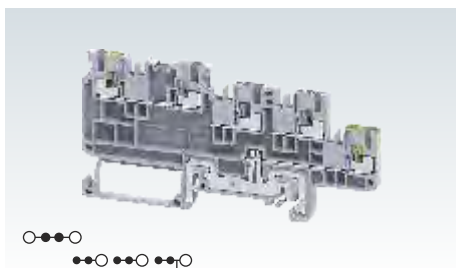

3.5 x 96.5 mm

48.1 mm / 55.55 mm

IEC	UL - CSA
0.2 - 1.5 mm ²	24 - 14 AWG
0.2 - 2.5 mm ²	24 - 12 AWG
0.2 - 1.5 mm ²	24 - 16 AWG

8 mm

IEC60947-7-1 UL-1059

250 V	150 V		
13.5 A	15 A		



Polyamide 6,6 / 1

4 KV / 3

Type / Cat. No.	Standard Pack
CPSTG1.5/4	50
CPSTG1.5/4L*	50
EPCPPT2.5/4	50
CA701-1M / CA701-1M-S	50 m
CA701-15-1M / CA701-15-1M-S	25 m
CA103 / CA104 / CA802	50
MS3.5WHT	100
SCM0.4/2.5 Blade size: 0.4 x 2.5 mm	10

Orange Jumper	Blue Jumper	Red Jumper	I _{max}	Std. Pack
JX1.5/2	JX1.5/2BU	JX1.5/2R	16 A	100
JX1.5/3	JX1.5/3BU	JX1.5/3R	16 A	100
JX1.5/4	JX1.5/4BU	JX1.5/4R	16 A	100
JX1.5/10	JX1.5/10BU	JX1.5/10R	16 A	10

CPPTG2.5/4

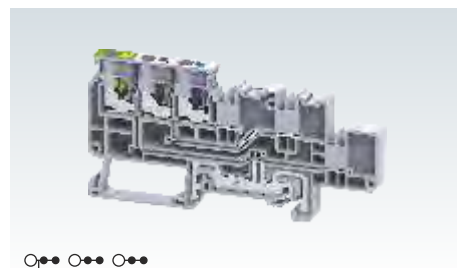

7 x 96.5 mm

48.1 mm / 55.55 mm

IEC	UL - CSA
0.2 - 2.5 mm ²	24 - 14 AWG
0.2 - 4.0 mm ²	24 - 12 AWG
0.2 - 2.5 mm ²	24 - 14 AWG

0.5 mm²

22 AWG

10 mm

IEC60947-7-1 UL-1059

250 V	300 V		
20 A	16 A		



Polyamide 6,6 / 1

4 KV / 3

Type / Cat. No.	Standard Pack
CPPT2.5/3	50
CPPTG2.5/4	50
EPCPPT2.5/3	50
EPCPPT2.5/4	50
CA701-1M / CA701-1M-S	50 m
CA701-15-1M / CA701-15-1M-S	25 m
CA103 / CA104 / CA802	50
MS3.5WHT	100
SCM0.5/3 Blade size: 0.5 x 3 mm	10

Orange Jumper	Blue Jumper	Red Jumper	I _{max}	Std. Pack
JX1.5/2	JX1.5/2BU	JX1.5/2R	16 A	100
JX1.5/3	JX1.5/3BU	JX1.5/3R	16 A	100
JX1.5/4	JX1.5/4BU	JX1.5/4R	16 A	100
JX1.5/10	JX1.5/10BU	JX1.5/10R	16 A	10

MARSHALLING TERMINAL BLOCKS

CP8L32 is an 8 level marshalling Terminal Block. It offers 32 connection points in a space saving configuration for potential and signal distribution. It has Push-In technology for easy wiring connection. Standard test probes can be inserted to carry out various test protocols.

CP8L32(I.S) is internally shorted Terminal Block offering multiple connection points for distribution applications.

Colour coding provides easy identification of the termination point to ensure error free operation.

In CP8L32(I.S)H the top four levels are interconnected and the bottom four levels are shorted. They are independent of each other and are used for signal distribution applications.

CP8L32

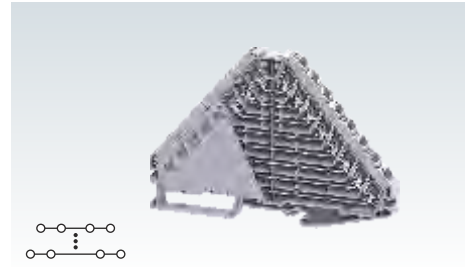

Width (Thickness) x Length	9 x 120 mm		
Height with DIN 35 x 7.5 / 35 x 15 mm Rail	84 mm / 91.5 mm		
Connection Possibility as per	IEC	UL - CSA	
With 1 Conductor per clamp	Stranded / Flexible	0.2 - 1.5 mm ²	24 - 14 AWG
	Solid	0.2 - 2.5 mm ²	24 - 12 AWG
	with Ferrule / Lug	0.2 - 1.5 mm ²	24 - 16 AWG
With 2 same size Conductors per clamp	with TWIN Ferrule / Lug		
Wire Stripping Length	8 mm		
Ratings As Per	IEC60947-7-1	UL-1059	
Voltage	320 V	300 V	
Current	8 A	10 A	
Approval			
Insulation Material / Material Group	Polyamide 6,6 / 1		
Rated Impulse Voltage / Pollution Degree	4 KV / 3		

	Type / Cat. No.	Standard Pack
Terminal Block	CP8L32	10
Mounting Rail (Refer Pg. 217 for details)	CA701-1M / CA701-1M-S	50 m
	CA701-15-1M / CA701-15-1M-S	25 m
End Clamp (Refer Pg. 218 for details)	CA702 / CA802 / CA103	50
Separator Plate	SPCP8L32	10
Retaining Bracket	RBCP8L32	10
Marker for SP	CA509/K3.5V	80
Marking Tags (Refer Pg. 222 for details)	CA509/K9WHT	100
Screw Driver	SCM0.4/2.5 Blade size: 0.4 x 2.5 mm	10

CP8L32(I.S)

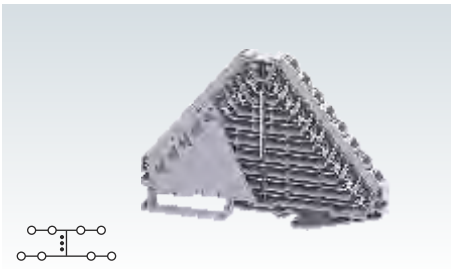

9 x 120 mm
84 mm / 91.5 mm

IEC	UL - CSA
0.2 - 1.5 mm ²	24 - 14 AWG
0.2 - 2.5 mm ²	24 - 12 AWG
0.2 - 1.5 mm ²	24 - 16 AWG

8 mm

IEC60947-7-1 UL-1059

320 V	300 V		
8 A	10 A		



Polyamide 6,6 / 1
4 KV / 3

Type / Cat. No.	Standard Pack
CP8L32(I.S)	10
CA701-1M / CA701-1M-S	50 m
CA701-15-1M / CA701-15-1M-S	25 m
CA702 / CA802 / CA103	50
SPCP8L32	10
RBCP8L32	10
CA509/K3.5V	80
CA509/K9WHT	100
SCM0.4/2.5 Blade size: 0.4 x 2.5 mm	10

CP8L32(I.S)H

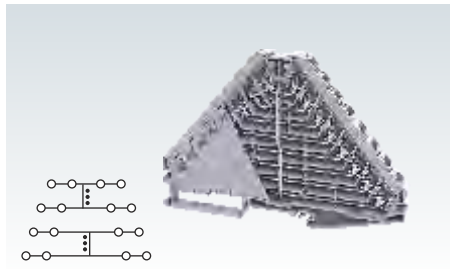

9 x 120 mm
84 mm / 91.5 mm

IEC	UL - CSA
0.2 - 1.5 mm ²	24 - 14 AWG
0.2 - 2.5 mm ²	24 - 12 AWG
0.2 - 1.5 mm ²	24 - 16 AWG

8 mm

IEC60947-7-1 UL-1059

320 V	300 V		
8 A	10 A		



Polyamide 6,6 / 1
4 KV / 3

Type / Cat. No.	Standard Pack
CP8L32(I.S)H	10
CA701-1M / CA701-1M-S	50 m
CA701-15-1M / CA701-15-1M-S	25 m
CA702 / CA802 / CA103	50
SPCP8L32	10
RBCP8L32	10
CA509/K3.5V	80
CA509/K9WHT	100
SCM0.4/2.5 Blade size: 0.4 x 2.5 mm	10

STUD & BOLT TYPE TERMINAL BLOCKS

Stud Type Terminal Blocks are used in application subject to severe vibration. Connection is made by crimping the wire on a ring / fork lug which is screwed on to the flat current bar.



STUD & BOLT TYPE TERMINAL BLOCKS



Feed Through

173 - 181

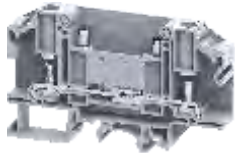

Disconnect & Test

182 - 188



Power Terminal Blocks

189 - 193

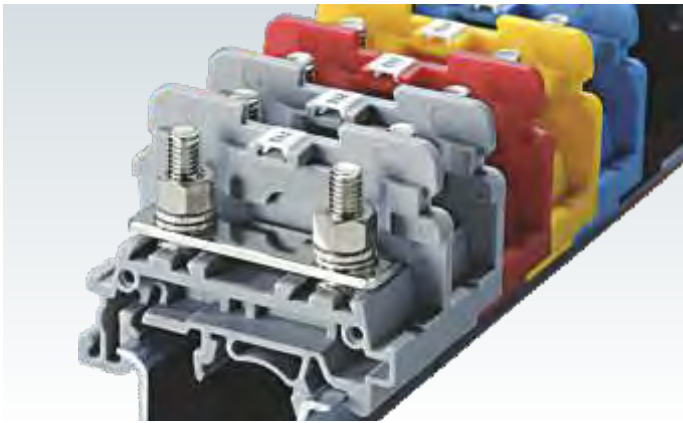

High Torque clamping system for ring & fork type lugs / ferrules. Extremely effective clamping system for areas prone to high vibrations.



Multiple wires can be connected on a single clamping point. The bolt & nut system make these multi wire connections safe and secure.

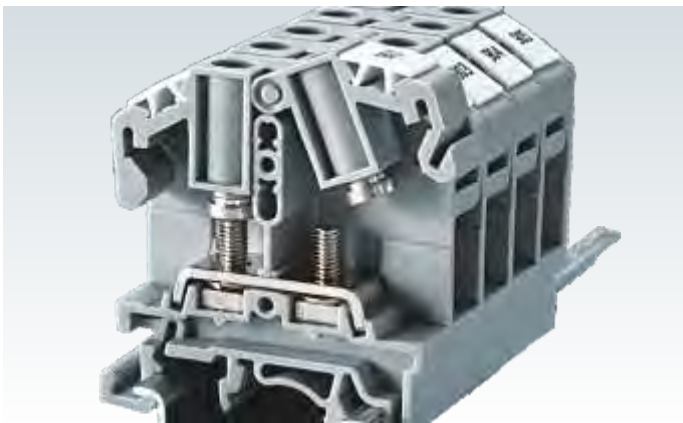

The fastening nut remains captive in the hinged plastic carrier. The nut is tightened by using a standard screwdriver.

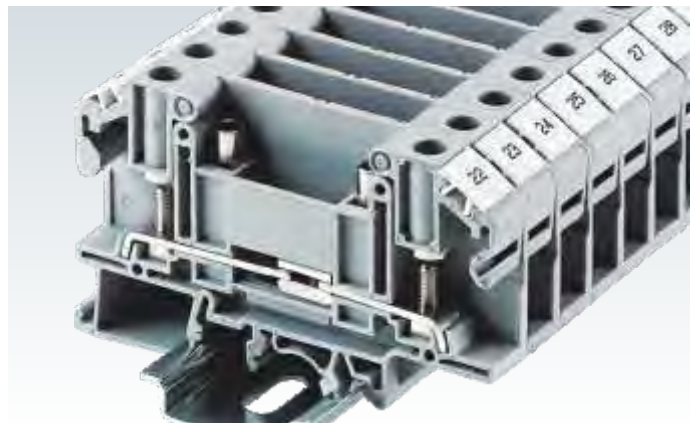

Disconnecting Terminal Block system is a versatile wire connection method for current transformer and power meters. A wide range of accessories eases the testing of these connected instruments.

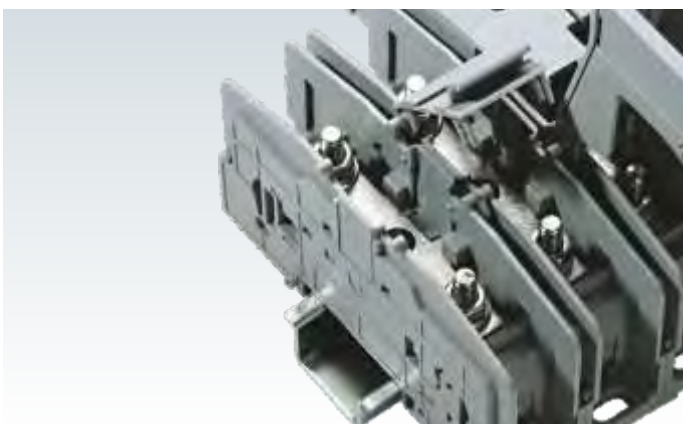

High current Terminal Blocks with a captive bolt provide extremely reliable connection for higher size wires. Integral isolation plates make these terminals extremely safe.



All open connection stud type Terminal Blocks can be covered with a protective shroud. The resulting assemblies are completely shock proof.

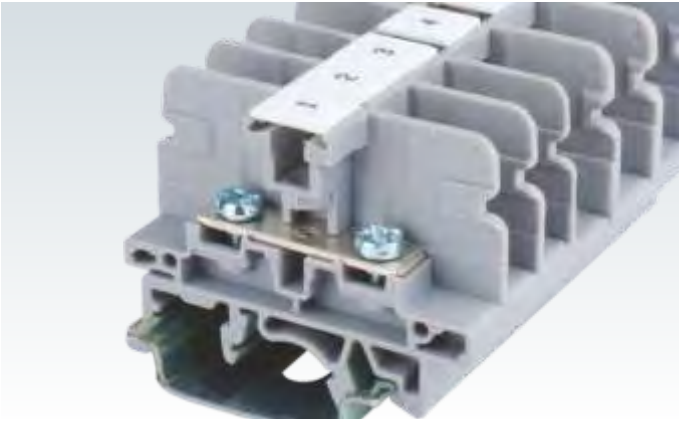

Barrier type Terminal Block CBS Series are an ideal choice for quick wire connection with ring & fork type lugs. Terminals can be interconnected using standard shorting accessories.

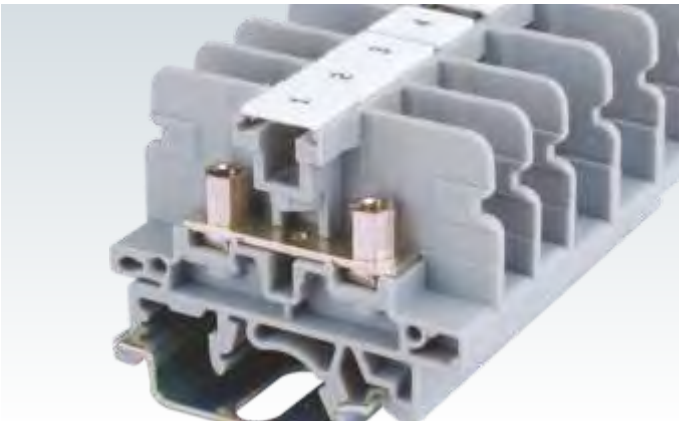

CSB series standard stud type terminals can be operated with screw / nut driver. Circuit identification can be achieved with standard marking tags.

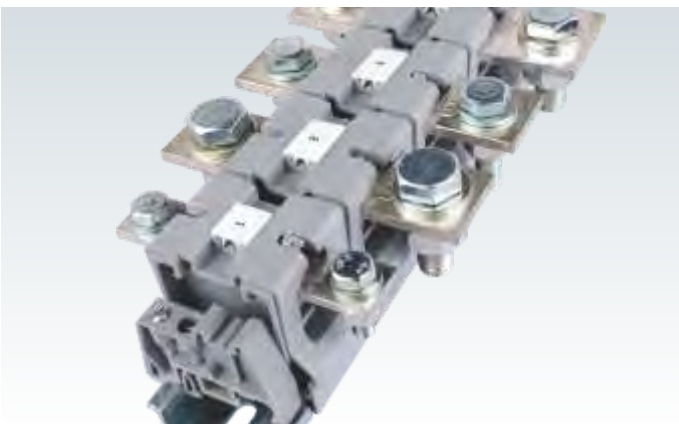

High current Bus Bar Terminal Blocks are available upto 185sq.mm cable connections.

FEED THROUGH TERMINAL BLOCKS

STH Series Terminal Blocks are preferred for application where the connections are subjected to severe vibration. The wire is crimped to a ring / fork lug and is screwed on to the flat current bar of the Terminal Block. The fastening nut always remains captive in the hinged plastic carrier. The hinged carrier should be lifted to insert the lugged / crimped wire and then snapped back into position. The nut can then be fastened to complete the connection. The nut can be operated by using a standard screwdriver.

These Terminal Blocks have IP20 (Finger Safe) protection & do not need any additional shrouding.

Two Lugs can be connected to the Terminal, without sacrificing the safety of the Terminal Block.

STH4TP terminals have socket headed screws to accept standard Ø4.3 mm test plugs.

In STH3 & STH6 terminals internal screw type jumpers can be used for cross connection. This is in addition to the available external jumpers.

Width (Thickness) x Length		9 x 47 mm
Height with DIN 35 x 7.5 / 35 x 15 / 32 mm Rail		47.25 mm / 54.75 mm / 52.1 mm
Connection Possibility as per		
With 1 Conductor per clamp	Stranded / Flexible with Ferrule / Lug Solid with Ferrule / Lug	
With 2 same size Conductors per clamp	Stranded / Flexible with Ferrule / Lug	
Ratings As Per		
Voltage		1000 V 600 V 600 V 630 V
Current		41 A 50 A 50 A 36 A
Torque		0.5 Nm 4.5 lb-in 4.5 lb-in 0.5 Nm
Approvals		
Insulation Material / Material Group		Polyamide 6,6 / 1
Rated Impulse Voltage / Pollution Degree		8 KV / 3

STH3



9 x 47 mm			
47.25 mm / 54.75 mm / 52.1 mm			
IEC		UL - CSA	
1.5 - 6.0 mm ²		22 - 8 AWG	
1.5 - 6.0 mm ²		22 - 8 AWG	
1.5 - 6.0 mm ²		22 - 8 AWG	
IEC60947-7-1	UL-1059	CSA22.2-158	IEC60079-7
1000 V	600 V	600 V	630 V
41 A	50 A	50 A	36 A
0.5 Nm	4.5 lb-in	4.5 lb-in	0.5 Nm
Polyamide 6,6 / 1			
8 KV / 3			

Terminal Block	With Standard Screw With Socket Headed Screw
End Plate	
Mounting Rail (Refer Pg. 217 for details)	
End Clamp (Refer Pg. 218 for details)	
Marking Tags (Refer Pg. 222 for details)	
Screw Driver	
Stud Size	M3
Jumpers	
Removable Jumpers	2 pole
	3 pole
	4 pole
Permanent Jumpers	2 pole
	3 pole
	4 pole
Screw Type Jumpers	2 pole
	3 pole
	4 pole
	10 pole

Type / Cat. No.	Standard Pack
STH3	100
EPSTH3	50
CA701-1M / CA701-1M-S	50 m
CA701-15-1M / CA701-15-1M-S	25 m
CA702 / CA802	50
CA509/K8WHT	100
SCS0.8/4 Blade size: 0.8 x 4 mm	10
Insulated	
CA512/15-2	CA514/15-2 35 A 100
CA512/15-3	CA514/15-3 35 A 50
CA512/15-4	CA514/15-4 35 A 50
CA512/17-2	CA514/17-2 35 A 100
CA512/17-3	CA514/17-3 35 A 50
CA512/17-4	CA514/17-4 35 A 50
CA773/2	41 A 100
CA773/3	41 A 50
CA773/4	41 A 50
CA773/10	41 A 10



STH4 / STH4TP



11 x 46 mm
52.2 mm / 59.0 mm / 56.4 mm

IEC	UL - CSA
1.5 - 6.0 mm ²	22 - 8 AWG

1.5 - 6.0 mm ²	22 - 8 AWG
---------------------------	------------

IEC60947-7-1	UL-1059	CSA22.2-158	IEC60079-7
1000 V	600 V	600 V	500 V
41 A	50 A	50 A	36 A
1.2 Nm	14 lb-in	14 lb-in	1.2 Nm



Polyamide 6,6 / 1

8 KV / 3

STH6



18 x 63.5 mm
63.1 mm / 70.6 mm / 68 mm

IEC	UL - CSA
1.5 - 35.0 mm ²	22 - 2 AWG

1.5 - 35.0 mm ²	22 - 2 AWG
----------------------------	------------

IEC60947-7-1	UL-1059	CSA22.2-158	IEC60079-7
1000 V	600 V	600 V	630 V
125 A	115 A	115 A	110 A
3.0 Nm	25 lb-in	25 lb-in	2.5 Nm



Polyamide 6,6 / 1

8 KV / 3

Type / Cat. No.	Standard Pack
STH4	50
STH4TP	50
EPSTH4	50
CA701-1M / CA701-1M-S	50 m
CA701-15-1M / CA701-15-1M-S	25 m
CA702 / CA802	50
CA509/K10WHT	100
SCS0.8/4 Blade size: 0.8 x 4 mm	10

M4

Uninsulated	Insulated	I _{max}	Standard Pack
CA512/13-2	CA514/13-2	35 A	100
CA512/13-3	CA514/13-3	35 A	50
CA512/13-4	CA514/13-4	35 A	50
CA512/14-2	CA514/14-2	35 A	100
CA512/14-3	CA514/14-3	35 A	50
CA512/14-4	CA514/14-4	35 A	50

Type / Cat. No.	Standard Pack
STH6	50
EPSTH6	50
CA701-1M / CA701-1M-S	50 m
CA701-15-1M / CA701-15-1M-S	25 m
CA702 / CA802 / CA202	50
CA509/K16WHT	100
SCS1/5.5 Blade size: 1.0 x 5.5 mm	10

M6

Uninsulated	Insulated	I _{max}	Standard Pack
CA774/2		110 A	100
CA774/3		110 A	50
CA774/4		110 A	50

FEED THROUGH TERMINAL BLOCKS

CBS3U, CBS4U & CBS5U are barrier type Terminal Blocks for quick wire connection of ring & fork type lugs / ferrules.

CSB3/N3U, CSB4/N4U & CSB5/N5U terminals are standard stud type terminals. CSB3/N3UL terminal has longer barrel nut for better access. The terminals can be operated using either a screw driver or a nut driver.

All the terminals can be shorted using both external & internal jumpers.

CSB3/N3USH, CSB4/N4USH, CSB5/N5USH & CSTSN6USH terminals have built in hinged shrouds. These Terminal Blocks have IP 20 (Finger safe) protection and do not need any additional shrouding.

CSE5U Terminal Block is used for earth link disconnection application. The Terminal Block can be operated using nut driver.

CBS3U



Width (Thickness) x Length		9 x 49 mm			
Height with DIN 35 x 7.5 / 35 x 15 / 32 mm Rail		38 mm / 45.6 mm / 43.1 mm			
Connection Possibility as per		IEC		UL - CSA	
With 1 Conductor per clamp	Stranded / Flexible with Ferrule / Lug	0.5 - 6.0 mm ²		22 - 8 AWG	
With 2 same size Conductors per clamp	Stranded / Flexible with Ferrule / Lug	0.5 - 4.0 mm ²		22 - 10 AWG	
Ratings As Per		IEC60947-7-1	UL-1059	CSA22.2-158	IEC60079-7
Voltage		1100 V	600 V	600 V	500 V
Current		41 A	50 A	50 A	36 A
Torque		0.5 Nm	4.5 lb-in	4.5 lb-in	0.5 Nm
Approvals					
Insulation Material / Material Group		Polyamide 6,6 / 1			
Rated Impulse Voltage / Pollution Degree		8 KV / 3			

		Type / Cat. No.	Standard Pack
Terminal Block	Grey	CBS3U	100
End Plate		EPCBS3U	50
Mounting Rail	(Refer Pg. 217 for details)	CA701-1M / CA701-1M-S	50 m
		CA701-15-1M / CA701-15-1M-S	25 m
End Clamp	(Refer Pg. 218 for details)	CA702 / CA802	50
Marking Tags	(Refer Pg. 222 for details)	CA509/K9WHT	100
Screw Driver		SCPH2	10
Nut Driver			
Screw / Stud Size		M3	

Jumpers		Uninsulated	Insulated	I _{max}	Standard Pack	
Removable Jumpers		2 pole	CA512/15-2	CA514/15-2	35 A	100
		3 pole	CA512/15-3	CA514/15-3	35 A	50
		4 pole	CA512/15-4	CA514/15-4	35 A	50
Permanent Jumpers		2 pole	CA512/17-2	CA514/17-2	35 A	100
		3 pole	CA512/17-3	CA514/17-3	35 A	50
		4 pole	CA512/17-4	CA514/17-4	35 A	50
Screw Type Jumpers		2 pole	CA728/2		41 A	50
		3 pole	CA728/3		41 A	50
		4 pole	CA728/4		41 A	50
		10 pole	CA728/10		41 A	10
Protective Cover		2 Terminal	CSTSPC2			10
		3 Terminal	CSTSPC2-1			10
		4 Terminal				
Long Protective Cover		100 mm	CSTSPC1-2			10
		200 mm	CSTSPC1-3			10
		300 mm	CSTSPC1-4			10

CBS4U



13 x 49 mm

38 mm / 45.6 mm / 43.1 mm

IEC UL - CSA

1.5 - 10.0 mm² 16 - 6 AWG

1.5 - 6.0 mm² 16 - 8 AWG

IEC60947-7-1 UL-1059 CSA22.2-158 IEC60079-7

1100 V 600 V 600 V 500 V

57 A 65 A 65 A 52 A

1.2 Nm 10 lb-in 10 lb-in 1.2 Nm



Polyamide 6,6 / 1

8 KV / 3

CBS5U



13 x 49 mm

38 mm / 45.6 mm / 43.1 mm

IEC UL - CSA

1.5 - 16.0 mm² 16 - 4 AWG

1.5 - 10.0 mm² 16 - 6 AWG

IEC60947-7-1 UL-1059 CSA22.2-158 IEC60079-7

1100 V 600 V 600 V 630 V

76 A 85 A 85 A 68 A

2.0 Nm 25 lb-in 25 lb-in 2.0 Nm



Polyamide 6,6 / 1

8 KV / 3

CSB3/N3U



9 x 49 mm

38 mm / 45.6 mm / 43.1 mm

IEC UL - CSA

0.5 - 6.0 mm² 22 - 8 AWG

0.5 - 4.0 mm² 22 - 10 AWG

IEC60947-7-1 UL-1059 CSA22.2-158 IEC60079-7

1100 V 600 V 600 V 500 V

41 A 50 A 50 A 36 A

0.5 Nm 4.5 lb-in 4.5 lb-in 0.5 Nm



Polyamide 6,6 / 1

8 KV / 3

Type / Cat. No.	Standard Pack
CBS4U	100
EPCBS3U	50
CA701-1M / CA701-1M-S	50 m
CA701-15-1M / CA701-15-1M-S	25 m
CA702 / CA802	50
CA509/K9WHT	100
SCPH2	10
M4	

Type / Cat. No.	Standard Pack
CBS5U	100
EPCBS3U	50
CA701-1M / CA701-1M-S	50 m
CA701-15-1M / CA701-15-1M-S	25 m
CA702 / CA802	50
CA509/K9WHT	100
SCPH2	10
M4	

Type / Cat. No.	Standard Pack
CSB3/N3U	100
EPCBS3U	50
CA701-1M / CA701-1M-S	50 m
CA701-15-1M / CA701-15-1M-S	25 m
CA702 / CA802	50
CA509/K9WHT	100
SCS1/5.5 Blade size: 1.0 x 5.5 mm	10
SCNT5	10
M3	

Uninsulated	Insulated	I _{max}	Standard Pack
CA512/2-2	CA514/2-2	45 A	100
CA512/2-3	CA514/2-3	45 A	50
CA512/2-4	CA514/2-4	45 A	50
CA512/4-2	CA514/4-2	45 A	100
CA512/4-3	CA514/4-3	45 A	50
CA512/4-4	CA514/4-4	45 A	50
CA772/2		57 A	100
CA772/3		57 A	100
CA772/4		57 A	100
CA772/10		57 A	10
CSTSPC2			10
CSTSPC2-1			10
CSTSPC1-2			10
CSTSPC1-3			10
CSTSPC1-4			10

Uninsulated	Insulated	I _{max}	Standard Pack
CA512/2-2	CA514/2-2	45 A	100
CA512/2-3	CA514/2-3	45 A	50
CA512/2-4	CA514/2-4	45 A	50
CA512/4-2	CA514/4-2	45 A	100
CA512/4-3	CA514/4-3	45 A	50
CA512/4-4	CA514/4-4	45 A	50
CA772/2		60 A	100
CA772/3		60 A	100
CA772/4		60 A	100
CA772/10		60 A	10
CSTSPC2			10
CSTSPC2-1			10
CSTSPC1-2			10
CSTSPC1-3			10
CSTSPC1-4			10

Uninsulated	Insulated	I _{max}	Standard Pack
CA512/15-2	CA514/15-2	35 A	100
CA512/15-3	CA514/15-3	35 A	50
CA512/15-4	CA514/15-4	35 A	50
CA512/17-2	CA514/17-2	35 A	100
CA512/17-3	CA514/17-3	35 A	50
CA512/17-4	CA514/17-4	35 A	50
CA728/2		41 A	50
CA728/3		41 A	50
CA728/4		41 A	50
CA728/10		41 A	10
CSTSPC2			10
CSTSPC2-1			10
CSTSPC1-2			10
CSTSPC1-3			10
CSTSPC1-4			10

CSB3/N3UL



CSB3/N3USH



Width (Thickness) x Length	9 x 49 mm				9 x 49 mm			
Height with DIN 35 x 7.5 / 35 x 15 / 32 mm Rail	38 mm / 45.6 mm / 43.1 mm				38 mm / 45.6 mm / 43.1 mm			
Connection Possibility as per	IEC		UL - CSA		IEC		UL - CSA	
With 1 Conductor per clamp	Stranded / Flexible with Ferrule / Lug		0.5 - 6.0 mm ²		22 - 8 AWG		0.5 - 6.0 mm ²	
With 2 same size Conductors per clamp	Stranded / Flexible with Ferrule / Lug		0.5 - 4.0 mm ²		22 - 10 AWG		0.5 - 4.0 mm ²	
Ratings As Per	IEC60947-7-1	UL-1059	CSA22.2-158	IEC60079-7	IEC60947-7-1	UL-1059	CSA22.2-158	IEC60079-7
Voltage	800 V	600 V	600 V	500 V	1000 V	600 V	600 V	500 V
Current	41 A	50 A	50 A	36 A	41 A	50 A	50 A	36 A
Torque	0.5 Nm	4.5 lb-in	4.5 lb-in	0.5 Nm	0.5 Nm	4.5 lb-in	4.5 lb-in	0.5 Nm
Approvals								
Insulation Material / Material Group	Polyamide 6,6 / 1				Polyamide 6,6 / 1			
Rated Impulse Voltage / Pollution Degree	8 KV / 3				8 KV / 3			

	Type / Cat. No.	Standard Pack	Type / Cat. No.	Standard Pack
Terminal Block	CSB3/N3UL	100	CSB3/N3USH	100
End Plate	EPCBS3U	50	EPCBS3U	50
Mounting Rail (Refer Pg. 217 for details)	CA701-1M / CA701-1M-S CA701-15-1M / CA701-15-1M-S	50 m 25 m	CA701-1M / CA701-1M-S CA701-15-1M / CA701-15-1M-S	50 m 25 m
End Clamp (Refer Pg. 218 for details)	CA702 / CA802	50	CA702 / CA802	50
Marking Tags (Refer Pg. 222 for details)	CA509/K9WHT	100	CA509/K9WHT	100
Screw Driver	SCS1/5.5 Blade size: 1.0 x 5.5 mm	10	SCS1/5.5 Blade size: 1.0 x 5.5 mm	10
Nut Driver	SCNT5	10	SCNT5	10
Screw / Stud Size	M3		M3	

		Uninsulated	Insulated	I _{max}	Standard Pack	Uninsulated	Insulated	I _{max}	Standard Pack	
Removable Jumpers		2 pole	CA512/15-2	CA514/15-2	35 A	100	CA512/15-2	CA514/15-2	35 A	100
		3 pole	CA512/15-3	CA514/15-3	35 A	50	CA512/15-3	CA514/15-3	35 A	50
		4 pole	CA512/15-4	CA514/15-4	35 A	50	CA512/15-4	CA514/15-4	35 A	50
Permanent Jumpers		2 pole	CA512/17-2	CA514/17-2	35 A	100	CA512/17-2	CA514/17-2	35 A	100
		3 pole	CA512/17-3	CA514/17-3	35 A	50	CA512/17-3	CA514/17-3	35 A	50
		4 pole	CA512/17-4	CA514/17-4	35 A	50	CA512/17-4	CA514/17-4	35 A	50
Screw Type Jumpers		2 pole	CA728/2		41 A	50	CA728/2		41 A	50
		3 pole	CA728/3		41 A	50	CA728/3		41 A	50
		4 pole	CA728/4		41 A	50	CA728/4		41 A	50
		10 pole	CA728/10		41 A	10	CA728/10		41 A	10
Protective Cover		2 Terminal								
		3 Terminal	CSTSPC2			10	CSTSPC2			10
Long Protective Cover		4 Terminal	CSTSPC2-1			10	CSTSPC2-1			10
		100 mm	CSTSPC1-2			10	CSTSPC1-2			10
		200 mm	CSTSPC1-3			10	CSTSPC1-3			10
		300 mm	CSTSPC1-4			10	CSTSPC1-4			10

CSB4/N4U

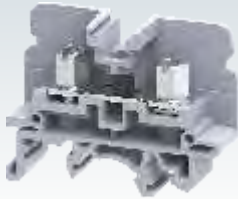

13 x 49 mm
38 mm / 45.6 mm / 43.1 mm

IEC	UL - CSA
1.5 - 10.0 mm ²	16 - 6 AWG

1.5 - 6.0 mm ²	16 - 8 AWG
---------------------------	------------

IEC60947-7-1	UL-1059	CSA22.2-158	IEC60079-7
1100 V	600 V	600 V	500 V
57 A	65 A	65 A	51 A
1.2 Nm	10 lb-in	10 lb-in	1.2 Nm



Polyamide 6,6 / 1

8 KV / 3

CSB4/N4USH



13 x 49 mm
38 mm / 45.6 mm / 43.1 mm

IEC	UL - CSA
1.5 - 10.0 mm ²	16 - 6 AWG

1.5 - 6.0 mm ²	16 - 8 AWG
---------------------------	------------

IEC60947-7-1	UL-1059	CSA22.2-158	IEC60079-7
1000 V	600 V	600 V	500 V
57 A	65 A	65 A	51 A
1.2 Nm	10 lb-in	10 lb-in	1.2 Nm



Polyamide 6,6 / 1

8 KV / 3

CSB5/N5U



13 x 49 mm
38 mm / 45.6 mm / 43.1 mm

IEC	UL - CSA
1.5 - 16.0 mm ²	16 - 4 AWG

1.5 - 10.0 mm ²	16 - 6 AWG
----------------------------	------------

IEC60947-7-1	UL-1059	CSA22.2-158	IEC60079-7
1100 V	600 V	600 V	630 V
76 A	85 A	85 A	68 A
2.0 Nm	25 lb-in	25 lb-in	2.0 Nm



Polyamide 6,6 / 1

8 KV / 3

Type / Cat. No.	Standard Pack
CSB4/N4U	100
EPCBS3U	50
CA701-1M / CA701-1M-S	50 m
CA701-15-1M / CA701-15-1M-S	25 m
CA702 / CA802	50
CA509/K9WHT	100
SCS1/5.5 Blade size: 1.0 x 5.5 mm	10

M4

Type / Cat. No.	Standard Pack
CSB4/N4USH	100
EPCBS3U	50
CA701-1M / CA701-1M-S	50 m
CA701-15-1M / CA701-15-1M-S	25 m
CA702 / CA802	50
CA509/K9WHT	100
SCS1/5.5 Blade size: 1.0 x 5.5 mm	10

M4

Type / Cat. No.	Standard Pack
CSB5/N5U	100
EPCBS3U	50
CA701-1M / CA701-1M-S	50 m
CA701-15-1M / CA701-15-1M-S	25 m
CA702 / CA802	50
CA509/K9WHT	100
SCS1/5.5 Blade size: 1.0 x 5.5 mm	10

M5

Uninsulated	Insulated	I _{max}	Standard Pack
CA512/2-2	CA514/2-2	45 A	100
CA512/2-3	CA514/2-3	45 A	50
CA512/2-4	CA514/2-4	45 A	50
CA512/4-2	CA514/4-2	45 A	100
CA512/4-3	CA514/4-3	45 A	50
CA512/4-4	CA514/4-4	45 A	50
CA772/2		57 A	100
CA772/3		57 A	100
CA772/4		57 A	100
CA772/10		57 A	10
CSTSPC2			10
CSTSPC2-1			10
CSTSPC1-2			10
CSTSPC1-3			10
CSTSPC1-4			10

Uninsulated	Insulated	I _{max}	Standard Pack
CA512/2-2	CA514/2-2	45 A	100
CA512/2-3	CA514/2-3	45 A	50
CA512/2-4	CA514/2-4	45 A	50
CA512/4-2	CA514/4-2	45 A	100
CA512/4-3	CA514/4-3	45 A	50
CA512/4-4	CA514/4-4	45 A	50
CA772/2		57 A	100
CA772/3		57 A	100
CA772/4		57 A	100
CA772/10		57 A	10
CSTSPC2			10
CSTSPC2-1			10
CSTSPC1-2			10
CSTSPC1-3			10
CSTSPC1-4			10

Uninsulated	Insulated	I _{max}	Standard Pack
CA512/2-2	CA514/2-2	45 A	100
CA512/2-3	CA514/2-3	45 A	50
CA512/2-4	CA514/2-4	45 A	50
CA512/4-2	CA514/4-2	45 A	100
CA512/4-3	CA514/4-3	45 A	50
CA512/4-4	CA514/4-4	45 A	50
CA772/2		60 A	100
CA772/3		60 A	100
CA772/4		60 A	100
CA772/10		60 A	10
CSTSPC2			10
CSTSPC2-1			10
CSTSPC1-2			10
CSTSPC1-3			10
CSTSPC1-4			10

CSB5/N5USH



CSTSN4U

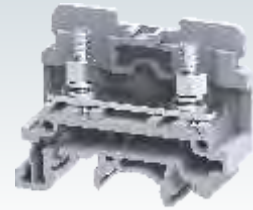

Width (Thickness) x Length	13 x 49 mm				17 x 50 mm			
Height with DIN 35 x 7.5 / 35 x 15 / 32 mm Rail	38 mm / 45.6 mm / 43.1 mm				40.7 mm / 48.0 mm / 46.3 mm			
Connection Possibility as per	IEC		UL - CSA		IEC		UL - CSA	
With 1 Conductor per clamp	Stranded / Flexible with Ferrule / Lug		1.5 - 16.0 mm ²		16 - 4 AWG		1.5 - 10.0 mm ²	
With 2 same size Conductors per clamp	Stranded / Flexible with Ferrule / Lug		1.5 - 10.0 mm ²		16 - 6 AWG		1.5 - 10.0 mm ²	
Ratings As Per	IEC60947-7-1	UL-1059	CSA22.2-158	IEC60079-7	IEC60947-7-1	UL-1059	CSA22.2-158	
Voltage	1000 V	600 V	600 V	630 V	1000 V	600 V	600 V	
Current	76 A	85 A	85 A	68 A	57 A	65 A	65 A	
Torque	2.0 Nm	25 lb-in	25 lb-in	2.0 Nm	1.2 Nm	14 lb-in	14 lb-in	
Approvals								
Insulation Material / Material Group	Polyamide 6,6 / 1				Polyamide 6,6 / 1			
Rated Impulse Voltage / Pollution Degree	8 KV / 3				8 KV / 3			

	Type / Cat. No.	Standard Pack	Type / Cat. No.	Standard Pack
Terminal Block	CSB5/N5USH	100	CSTSN4U	100
End Plate	EPCBS3U	50	EPCSTSU	50
Mounting Rail (Refer Pg. 217 for details)	CA701-1M / CA701-1M-S	50 m	CA701-1M / CA701-1M-S	50 m
	CA701-15-1M / CA701-15-1M-S	25 m	CA701-15-1M / CA701-15-1M-S	25 m
End Clamp (Refer Pg. 218 for details)	CA702 / CA802	50	CA702 / CA802	50
Marking Tags (Refer Pg. 222 for details)	CA509/K9WHT	100	CA509/K2B4WHT	100
Screw Driver	SCS1/5.5	Blade size: 1.0 x 5.5 mm		
Nut Driver				
Screw / Stud Size	M5		M4	

		Uninsulated	Insulated	I _{max}	Standard Pack	Uninsulated	Insulated	I _{max}	Standard Pack
Removable Jumpers	2 pole	CA512/2-2	CA514/2-2	45 A	100	CA512/1-2	CA514/1-2	45 A	100
	3 pole	CA512/2-3	CA514/2-3	45 A	50	CA512/1-3	CA514/1-3	45 A	50
	4 pole	CA512/2-4	CA514/2-4	45 A	50	CA512/1-4	CA514/1-4	45 A	50
Permanent Jumpers	2 pole	CA512/4-2	CA514/4-2	45 A	100	CA512/3-2	CA514/3-2	45 A	100
	3 pole	CA512/4-3	CA514/4-3	45 A	50	CA512/3-3	CA514/3-3	45 A	50
	4 pole	CA512/4-4	CA514/4-4	45 A	50	CA512/3-4	CA514/3-4	45 A	50
Screw Type Jumpers	2 pole	CA772/2		60 A	100				
	3 pole	CA772/3		60 A	100				
	4 pole	CA772/4		60 A	100				
	10 pole	CA772/10		60 A	10				
Protective Cover	2 Terminal	CSTSPC2			10	CSTSPC1			100
	3 Terminal	CSTSPC2-1			10	CSTSPC1-1			100
	4 Terminal								
Long Protective Cover	100 mm	CSTSPC1-2			10	CSTSPC1-2			10
	200 mm	CSTSPC1-3			10	CSTSPC1-3			10
	300 mm	CSTSPC1-4			10	CSTSPC1-4			10

CSTSN5U

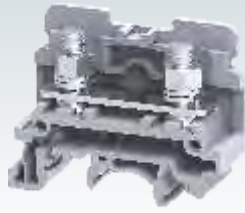

17 x 50 mm
40.7 mm / 48.0 mm / 46.3 mm

IEC **UL - CSA**

1.5 - 16.0 mm² 22 - 4 AWG

1.5 - 16.0 mm² 22 - 4 AWG

IEC60947-7-1	UL-1059	CSA22.2-158
1000 V	600 V	600 V
76 A	80 A	80 A
2.0 Nm	25 lb-in	25 lb-in



Polyamide 6,6 / 1

8 KV / 3

CSTSN6U



17 x 50 mm
40.7 mm / 48.0 mm / 46.3 mm

IEC **UL - CSA**

1.5 - 35.0 mm² 22 - 2 AWG

1.5 - 35.0 mm² 22 - 2 AWG

IEC60947-7-1	UL-1059	CSA22.2-158
1000 V	600 V	600 V
125 A	125 A	125 A
3.0 Nm	25 lb-in	25 lb-in



Polyamide 6,6 / 1

8 KV / 3

CSTSN6USH



17 x 50 mm
40.7 mm / 48.0 mm / 46.3 mm

IEC **UL - CSA**

1.5 - 35.0 mm² 22 - 2 AWG

1.5 - 35.0 mm² 22 - 2 AWG

IEC60947-7-1	UL-1059	CSA22.2-158
1000 V	600 V	600 V
125 A	125 A	125 A
3.0 Nm	25 lb-in	25 lb-in



Polyamide 6,6 / 1

8 KV / 3

Type / Cat. No.	Standard Pack
CSTSN5U	100
EPCSTSU	50
CA701-1M / CA701-1M-S	50 m
CA701-15-1M / CA701-15-1M-S	25 m
CA702 / CA802	50
CA509/K2B4WHT	100

M5

Type / Cat. No.	Standard Pack
CSTSN6U	100
EPCSTSU	50
CA701-1M / CA701-1M-S	50 m
CA701-15-1M / CA701-15-1M-S	25 m
CA702 / CA802	50
CA509/K2B4WHT	100

M6

Type / Cat. No.	Standard Pack
CSTSN6USH	100
EPCSTSU	50
CA701-1M / CA701-1M-S	50 m
CA701-15-1M / CA701-15-1M-S	25 m
CA702 / CA802	50
CA509/K2B4WHT	100

M6

Uninsulated	Insulated	I _{max}	Standard Pack
CA512/1-2	CA514/1-2	45 A	100
CA512/1-3	CA514/1-3	45 A	50
CA512/1-4	CA514/1-4	45 A	50
CA512/3-2	CA514/3-2	45 A	100
CA512/3-3	CA514/3-3	45 A	50
CA512/3-4	CA514/3-4	45 A	50

Uninsulated	Insulated	I _{max}	Standard Pack
CA512/7-2	CA514/7-2	50 A	100
CA512/7-3	CA514/7-3	50 A	50
CA512/7-4	CA514/7-4	50 A	50
CA512/8-2	CA514/8-2	50 A	100
CA512/8-3	CA514/8-3	50 A	50
CA512/8-4	CA514/8-4	50 A	50

Uninsulated	Insulated	I _{max}	Standard Pack
CA512/7-2	CA514/7-2	50 A	100
CA512/7-3	CA514/7-3	50 A	50
CA512/7-4	CA514/7-4	50 A	50
CA512/8-2	CA514/8-2	50 A	100
CA512/8-3	CA514/8-3	50 A	50
CA512/8-4	CA514/8-4	50 A	50

CSTSPC1	100
CSTSPC1-1	100
CSTSPC1-2	10
CSTSPC1-3	10
CSTSPC1-4	10

CSTSPC1	100
CSTSPC1-1	100
CSTSPC1-2	10
CSTSPC1-3	10
CSTSPC1-4	10

CSTSPC1	100
CSTSPC1-1	100
CSTSPC1-2	10
CSTSPC1-3	10
CSTSPC1-4	10

CSE5U



Width (Thickness) x Length	17 x 50 mm		
Height with DIN 35 x 7.5 / 35 x 15 / 32 mm Rail	40.7 mm / 48.0 mm / 46.3 mm		
Connection Possibility as per	IEC	UL - CSA	
With 1 Conductor per clamp	Stranded / Flexible with Ferrule / Lug	1.5 - 16.0 mm ²	22 - 4 AWG
With 2 same size Conductors per clamp	Stranded / Flexible with Ferrule / Lug	1.5 - 16.0 mm ²	22 - 4 AWG
Ratings As Per	IEC60947-7-1		
Voltage	800 V		
Current	76 A		
Torque	2.0 Nm		
Approvals			
Insulation Material / Material Group	Polyamide 6,6 / 1		
Rated Impulse Voltage / Pollution Degree			

		Type / Cat. No.	Standard Pack
Terminal Block	Grey	CSE5U*	100
End Plate		EPCSTSU	50
Mounting Rail (Refer Pg. 217 for details)		CA701-1M / CA701-1M-S CA701-15-1M / CA701-15-1M-S	50 m 25 m
End Clamp (Refer Pg. 218 for details)		CA702 / CA802	50
Marking Tags (Refer Pg. 222 for details)		CA509/K2B4WHT	100
Screw Driver		M5	
Nut Driver			
Screw / Stud Size			

		Uninsulated	Insulated	I _{max}	Standard Pack	
Removable Jumpers		2 pole	CA512/1-2	CA514/1-2	45 A	100
		3 pole	CA512/1-3	CA514/1-3	45 A	50
		4 pole	CA512/1-4	CA514/1-4	45 A	50
Permanent Jumpers		2 pole	CA512/3-2	CA514/3-2	45 A	100
		3 pole	CA512/3-3	CA514/3-3	45 A	50
		4 pole	CA512/3-4	CA514/3-4	45 A	50
Screw Type Jumpers		2 pole				
		3 pole				
		4 pole				
		10 pole				
Protective Cover		2 Terminal				
		3 Terminal				
		4 Terminal				
Long Protective Cover		100 mm				
		200 mm				
		300 mm				

* CSE5U Terminal Block is used for earth link disconnection application.

DISCONNECT & TEST TERMINAL BLOCKS

CBDT4U Disconnect & Test Terminal Block is used for measuring, control and regulatory circuits.

Disconnection is achieved by means of a slide link operated with a Screw Driver.

CBDT4U terminals have a barrel nut configuration which can be operated with a screw driver.

Adjacent terminal can be shorted with the aid of removable and permanent jumpers. Also pre assembled internal screw type jumpers can be used for shorting. Temporary shorting can be achieved using SWCBDT switchable jumpers.

CBDT4U

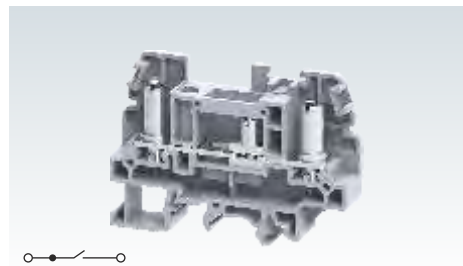

Width (Thickness) x Length	13 x 71 mm		
Height with DIN 35 x 7.5 / 35 x 15 / 32 mm Rail	50.2 mm / 57.7 mm / 54.8 mm		
Connection Possibility as per	IEC UL - CSA		
With 1 Conductor per clamp	Stranded / Flexible with Ferrule / Lug	1.5 - 6.0 mm ² 16 - 8 AWG	
	Solid with Ferrule / Lug	1.5 - 6.0 mm ²	
With 2 same size Conductors per clamp	Stranded / Flexible with Ferrule / Lug	1.5 - 6.0 mm ² 16 - 8 AWG	
Ratings As Per	IEC60947-7-1	UL-1059	CSA22.2-158
Voltage	1100 V	600 V	600 V
Current	41 A	45 A	45 A
Torque	1.2 Nm	14 lb-in	14 lb-in
Approvals			
Insulation Material / Material Group	Polyamide 6,6 / 1		
Rated Impulse Voltage / Pollution Degree	8 KV / 3		

	Type / Cat. No.	Standard Pack
Terminal Block	CBDT4U	50
End Plate	EPCBDT4U	50
Mounting Rail (Refer Pg. 217 for details)	CA701-1M / CA701-1M-S	50 m
	CA701-15-1M / CA701-15-1M-S	25 m
End Clamp (Refer Pg. 218 for details)	CA502 / CA702	50
Marking Tags (Refer Pg. 222 for details)	CA509/K2B4WHT	100
Screw Driver	SCS1/5.5 Blade size: 1.0 x 5.5 mm	10
Screw / Stud Size	M4	

Jumpers		Uninsulated	Insulated	I _{max}	Standard Pack
Removable Jumpers	2 pole	CA512/2-2	CA514/2-2	41 A	100
	3 pole	CA512/2-3	CA514/2-3	41 A	50
	4 pole	CA512/2-4	CA514/2-4	41 A	50
Permanent Jumpers	2 pole	CA512/4-2	CA514/4-2	41 A	100
	3 pole	CA512/4-3	CA514/4-3	41 A	50
	4 pole	CA512/4-4	CA514/4-4	41 A	50
Screw Type Jumpers	2 pole	CA775/2		25 A	100
	3 pole	CA775/3		25 A	50
	4 pole	CA775/4		25 A	50
	10 pole	CA775/10		25 A	10
Protective Cover	2 Terminal	CDTPC1			100
	3 Terminal	CDTPC2			100
	4 Terminal				
Long Protective Cover	100 mm	CDTPC3			10
	200 mm	CDTPC4			10
	300 mm	CDTPC5			10
Switchable Link Assembly	SWCBDT		41 A	50	

DISCONNECT & TEST TERMINAL BLOCKS

STH4DT Disconnect & Test Terminal Block is used for measuring, control and regulatory circuits. They provide a clear functional advantage for devices having utility instruments and associated transformers.

Separate testing points facilitate insertion of test probes. Disconnection is achieved by means of a slide link operated with a Screw Driver.

STH4DTSH Terminal Block has 2 STH4DT Terminal Blocks shorted to achieve switchable cross connection for current transformers (on one side).

STH4DTFT is a feed through terminal with the same profile of the STH4DT Terminal Block.

In all of the above Terminal Blocks, two Lugs can be connected to the Terminal, without sacrificing the safety of the Terminal Block.

Width (Thickness) x Length		11 x 86 mm
Height with DIN 35 x 7.5 / 35 x 15 / 32 mm Rail		52.2 mm / 59.0 mm / 56.4 mm
Connection Possibility as per		
With 1 Conductor per clamp	Stranded / Flexible with Ferrule / Lug Solid with Ferrule / Lug	
With 2 same size Conductors per clamp	Stranded / Flexible with Ferrule / Lug	
Ratings As Per		
Voltage		1000 V 600 V 600 V
Current		41 A 35 A 35 A
Torque		1.2 Nm 14 lb-in 14 lb-in
Approvals		
Insulation Material / Material Group		Polyamide 6,6 / 1
Rated Impulse Voltage / Pollution Degree		8 KV / 3

STH4DT

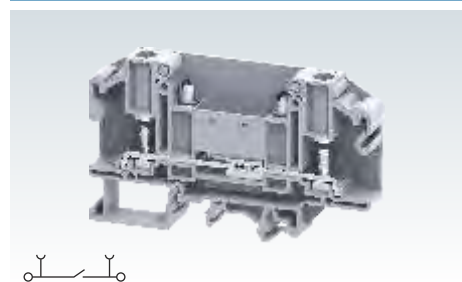

IEC		UL - CSA	
1.5 - 6.0 mm ²		22 - 8 AWG	
1.5 - 6.0 mm ²		22 - 8 AWG	
IEC60947-7-1	UL-1059	CSA22.2-158	
1000 V	600 V	600 V	
41 A	35 A	35 A	
1.2 Nm	14 lb-in	14 lb-in	
Polyamide 6,6 / 1			
8 KV / 3			

Terminal Block	With Standard Screw With Test Socket Tapped With Socket Headed Screw	
End Plate		
Mounting Rail	(Refer Pg. 217 for details)	
End Clamp	(Refer Pg. 218 for details)	
Marking Tags	(Refer Pg. 222 for details)	
Screw Driver		
Screw / Stud Size		

Type / Cat. No.	Standard Pack
STH4DT	50
STH4DT/S	50
STH4DTTP	50
EPSTH4DT	50
CA701-1M / CA701-1M-S	50 m
CA701-15-1M / CA701-15-1M-S	25 m
CA702 / CA802	50
CA509/K10WHT	100
SCS1.0/5.5	Blade size: 1.0 x 5.5 mm
10	

Jumpers		Uninsulated	Insulated	I _{max}	Standard Pack
Removable Jumpers		CA512/13-2	CA514/13-2	35 A	100
		CA512/13-3	CA514/13-3	35 A	50
		CA512/13-4	CA514/13-4	35 A	50
Permanent Jumpers		CA512/14-2	CA514/14-2	35 A	100
		CA512/14-3	CA514/14-3	35 A	50
		CA512/14-4	CA514/14-4	35 A	50
Alternate Permanent Jumpers		CA514/14-3A		35 A	10
		CA514/14-4A		35 A	10
Shorting Plug		QJ11/2			25
		QJ11/4			25
Lock Out Cap		LCSTH4DT			50

Type / Cat. No.	Standard Pack		
EPSTH4DT	50		
CA701-1M / CA701-1M-S	50 m		
CA701-15-1M / CA701-15-1M-S	25 m		
CA702 / CA802	50		
CA509/K10WHT	100		
SCS1.0/5.5	Blade size: 1.0 x 5.5 mm		
10			
M4			
Uninsulated	Insulated	I _{max}	Standard Pack
CA512/13-2	CA514/13-2	35 A	100
CA512/13-3	CA514/13-3	35 A	50
CA512/13-4	CA514/13-4	35 A	50
CA512/14-2	CA514/14-2	35 A	100
CA512/14-3	CA514/14-3	35 A	50
CA512/14-4	CA514/14-4	35 A	50
CA514/14-3A		35 A	10
CA514/14-4A		35 A	10
QJ11/2			25
QJ11/4			25
LCSTH4DT			50

STH4DTSH

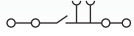
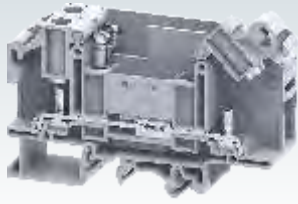

22 x 86 mm

52.2 mm / 59.0 mm / 56.4 mm

IEC	UL - CSA
1.5 - 6.0 mm ²	22 - 8 AWG

1.5 - 6.0 mm² 22 - 8 AWG

IEC60947-7-1	UL-1059	CSA22.2-158
1000 V	300 V	300 V
34 A	25 A	25 A
1.2 Nm	14 lb-in	14 lb-in



Polyamide 6,6 / 1

8 KV / 3

Type / Cat. No.	Standard Pack
STH4DTSH	24

EPSTH4DT	50
CA701-1M / CA701-1M-S	50 m
CA701-15-1M / CA701-15-1M-S	25 m
CA702 / CA802	50
CA509/K10WHT	100
SCS1.0/5.5 Blade size: 1.0 x 5.5 mm	10

M4

Uninsulated	Insulated	I _{max}	Standard Pack
CA512/13-2	CA514/13-2	34 A	100
CA512/13-3	CA514/13-3	34 A	50
CA512/13-4	CA514/13-4	34 A	50
CA512/14-2	CA514/14-2	34 A	100
CA512/14-3	CA514/14-3	34 A	50
CA512/14-4	CA514/14-4	34 A	50
CA514/14-3A		34 A	10
CA514/14-4A		34 A	10
QJ11/2			25
QJ11/4			25
LCSTH4DT			50

STH4DTFT

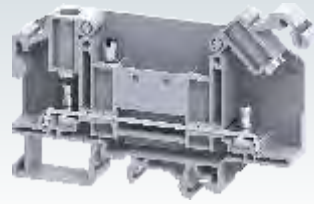

11 x 86 mm

52.2 mm / 59.0 mm / 56.4 mm

IEC	UL - CSA
1.5 - 6.0 mm ²	22 - 8 AWG

1.5 - 6.0 mm² 22 - 8 AWG

IEC60947-7-1	UL-1059	CSA22.2-158
1000 V	600 V	300 V
41 A	50 A	50 A
1.2 Nm	14 lb-in	14 lb-in



Polyamide 6,6 / 1

8 KV / 3

Type / Cat. No.	Standard Pack
STH4DTFT	50

EPSTH4DT	50
CA701-1M / CA701-1M-S	50 m
CA701-15-1M / CA701-15-1M-S	25 m
CA702 / CA802	50
CA509/K10WHT	100
SCS1.0/5.5 Blade size: 1.0 x 5.5 mm	10

M4

Uninsulated	Insulated	I _{max}	Standard Pack
CA512/13-2	CA514/13-2	35 A	100
CA512/13-3	CA514/13-3	35 A	50
CA512/13-4	CA514/13-4	35 A	50
CA512/14-2	CA514/14-2	35 A	100
CA512/14-3	CA514/14-3	35 A	50
CA512/14-4	CA514/14-4	35 A	50
CA514/14-3A		35 A	10
CA514/14-4A		35 A	10
QJ11/2			25
QJ11/4			25
LCSTH4DT			50

Usage of STH4DT Test Disconnect Terminal Block for metering CT for 3 wire system

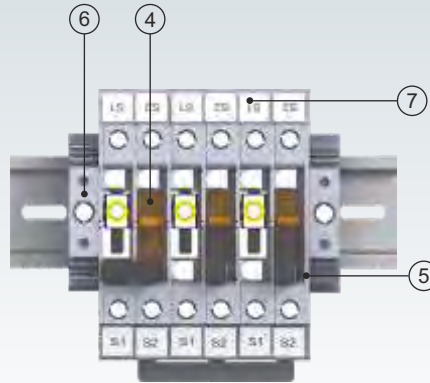
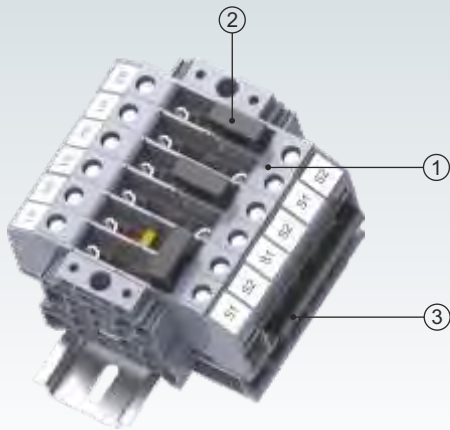

No.	Cat. No.	Qty.
1	STH4DT	6
2	QJ11/2	3
3	CA514/14-3A	1
4	LCSTH4DT	3
5	EPSTH4DT	1
6	CA202	2
7	CA509/K10	12

Operating Status

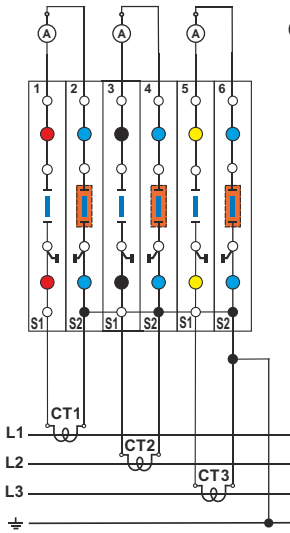

Measurement Standard for Phase L1

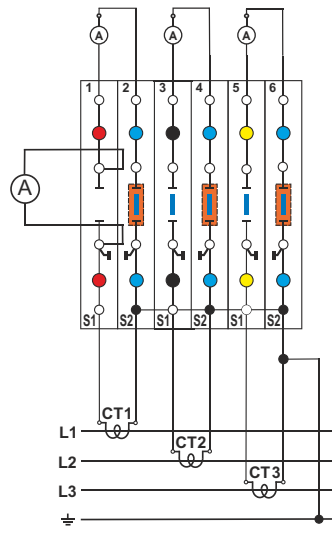

Sequence for test :

- 1) Connect a Ammeter to test sockets of terminal 1
- 2) Open disconnect slide link of terminal 1
- 3) Take the measurement

Measurement with External Current Source

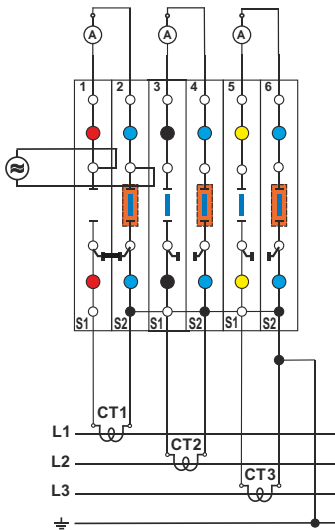

Sequence for test :

- 1) Close the terminals 1 & 2 with shorting plug QJ11/2
- 2) Open disconnect slide link of terminal 1
- 3) Connect the external source to the test sockets of the terminals 1 & 2.
- 4) Take the measurement

Replacement Meter for Phase L1

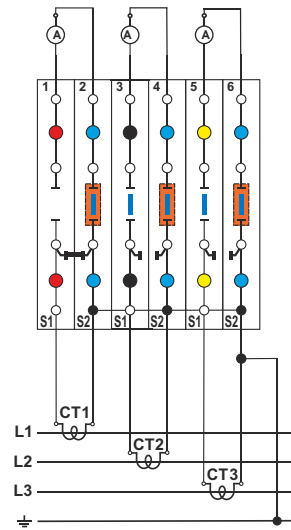

Sequence for test :

- 1) Close the terminals 1 & 2 with shorting plug QJ11/2
- 2) Open disconnect slide link of terminal 1
- 3) Disconnect the meter from phase R of the terminals 1 & 2.
- 4) Replace the meter

Usage of STH4DT Test Disconnect Terminal Block for metering CT for 4 wire system

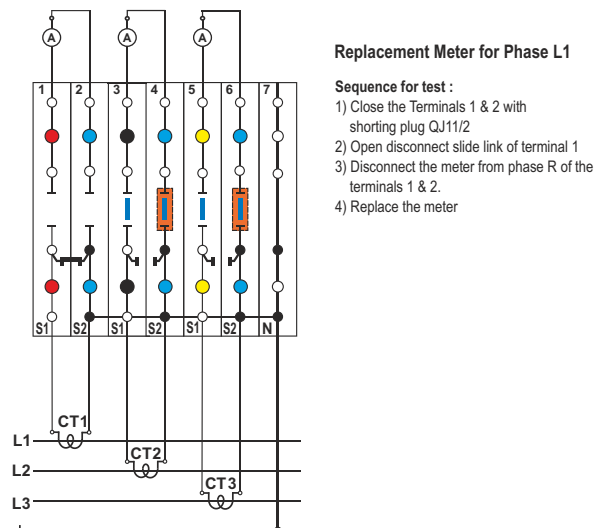
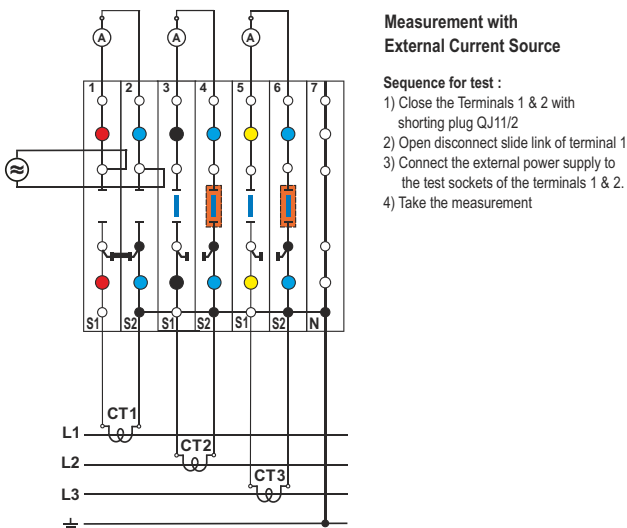
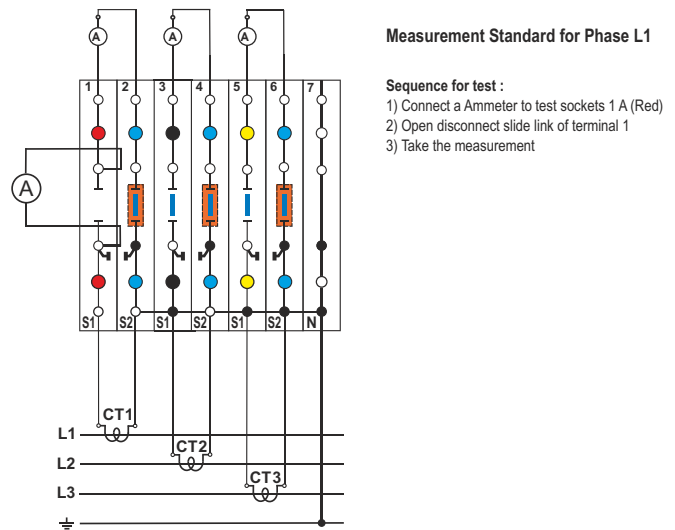
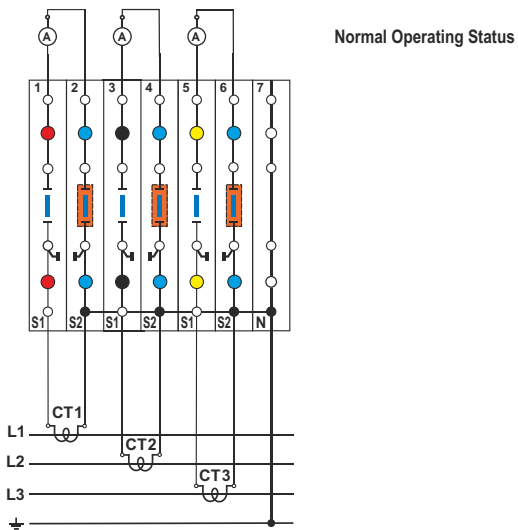
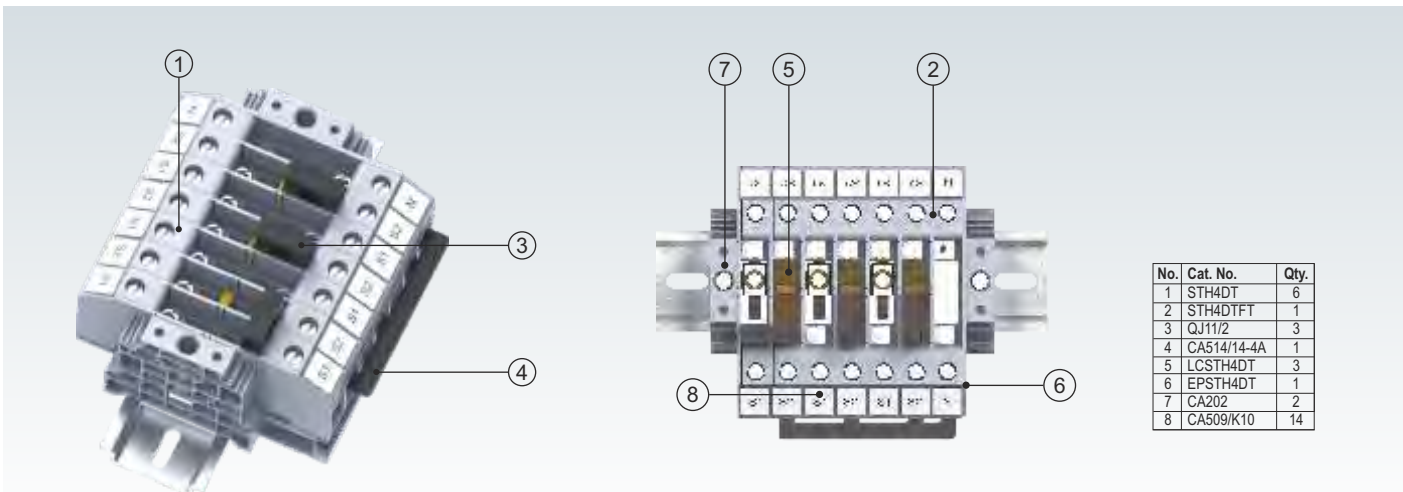

Usage of STH4DT Test Disconnect Terminal Block for multi function meter for 3 wire system

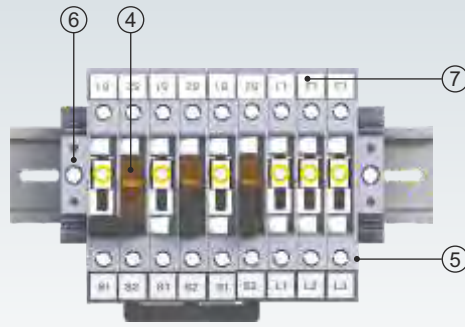
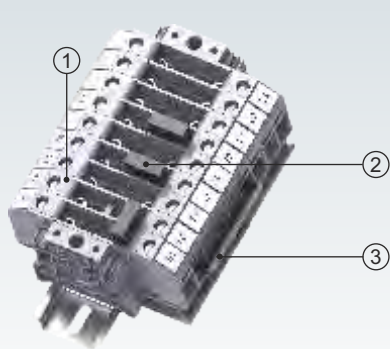

No.	Cat. No.	Qty.
1	STH4DT	9
2	QJ11/2	3
3	CA514/14-3A	1
4	LCSTH4DT	3
5	EPSTH4DT	1
6	CA202	2
7	CA509/K10	18

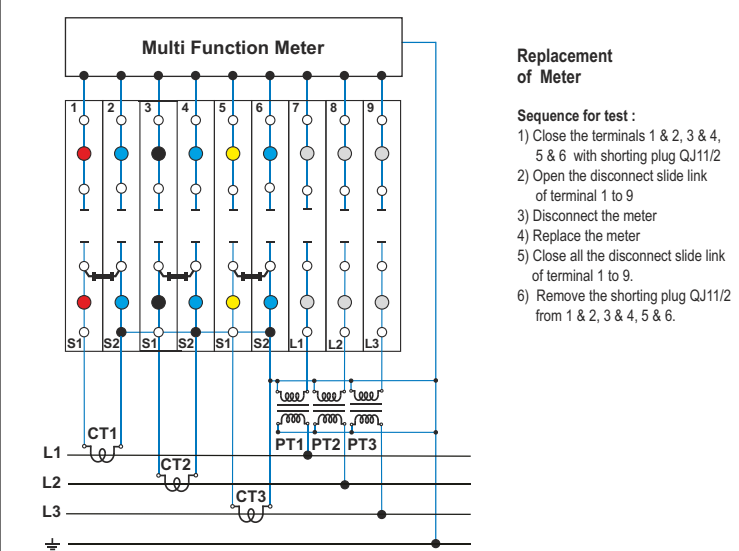
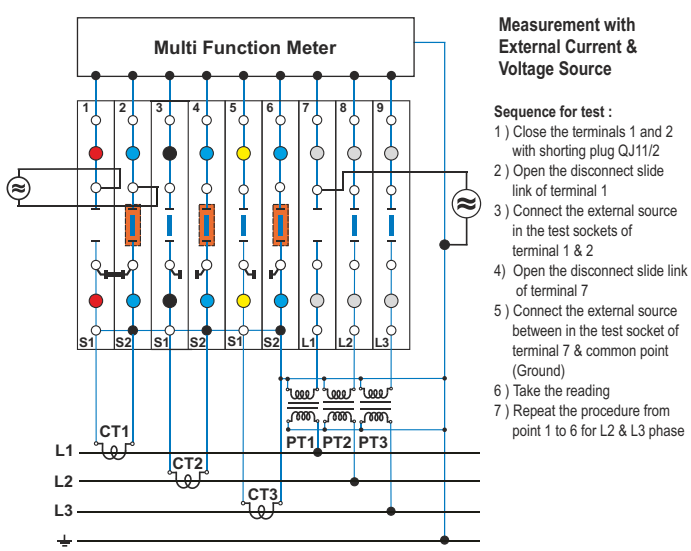
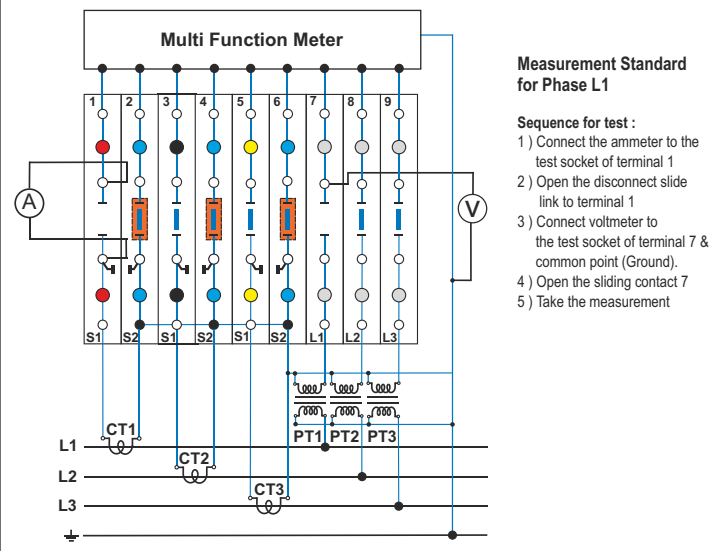
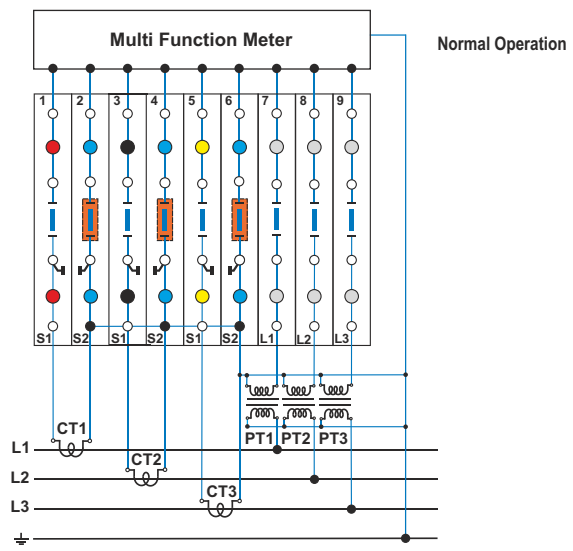

Usage of STH4DT Test Disconnect Terminal Block for multi function meter for 4 wire system

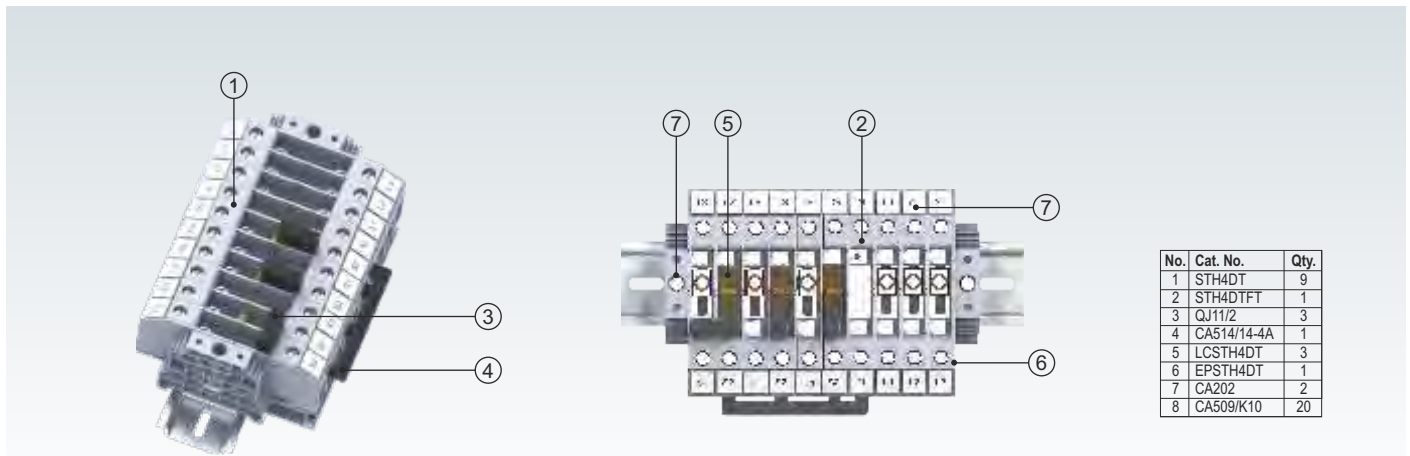

No.	Cat. No.	Qty.
1	STH4DT	9
2	STH4DTFT	1
3	QJ11/2	3
4	CA514/14-4A	1
5	LCSTH4DT	3
6	EPSTH4DT	1
7	CA202	2
8	CA509/K10	20

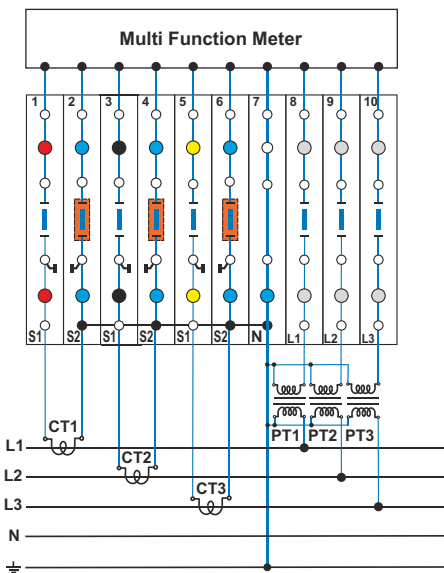

Normal Operation

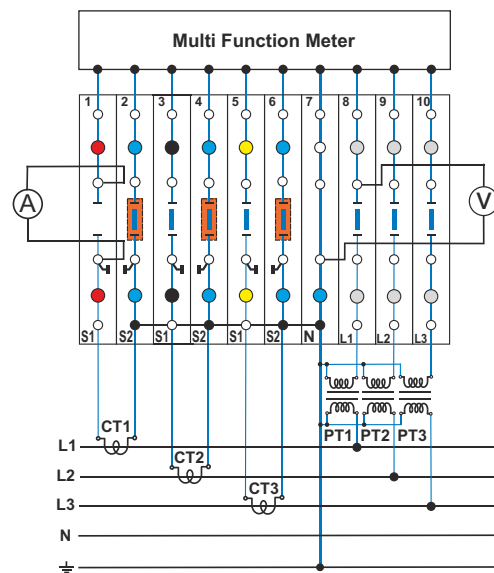

Measurement Standard for Phase L1

- Sequence for test :
- 1) Connect the ammeter to the test socket of terminal 1
 - 2) Open the disconnect slide link of terminal 1
 - 3) Take the measurement
 - 4) Connect voltmeter to terminal 7 & 8
 - 5) Take the measurement

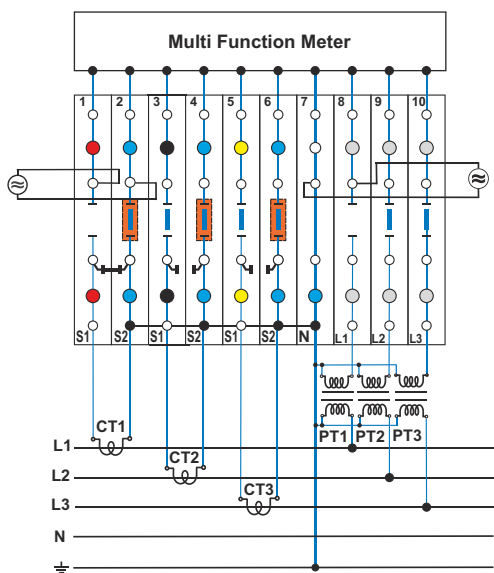

Measurement with External Current & Voltage Source

- Sequence for test :
- 1) Close the terminals 1 and 2 with shorting plug QJ11/2
 - 2) Open the disconnect slide link of terminal 1
 - 3) Connect the external source in the test sockets of terminal 1 & 2
 - 4) Open the disconnect slide link of terminal 7
 - 5) Connect the external source between in the test socket of terminal 7 & common point (Ground)
 - 6) Take the reading
 - 7) Repeat the procedure from point 1 to 6 for L2 & L3 phase

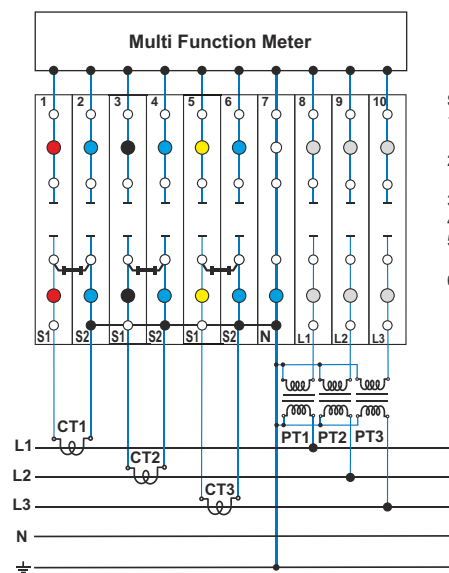

Replacement of Meter

- Sequence for test :
- 1) Close the terminals 1 & 2, 3 & 4, 5 & 6 with shorting plug QJ11/2
 - 2) Open the disconnect slide link of terminal 1 to 9
 - 3) Disconnect the meter
 - 4) Replace the meter
 - 5) Close all the disconnect slide link of terminal 1 to 9.
 - 6) Remove the shorting plug QJ11/2 from 1 & 2, 3 & 4, 5 & 6.

POWER TERMINAL BLOCKS

CBB series Terminal Blocks are preferred for application using wires of large cross section. The Wire is crimped to a ring / fork lug and is screwed on to the flat current bar of the Terminal Block. Specially designed Mounting Feet holds the Terminal Block rigidly on to the Mounting Rail.

Two Lugs of the rated cross section can be connected to the Terminal Block, without sacrificing the safety of the Terminal Block.

PPCBB series partition plates can be installed even after assembly of cables on the Terminal Blocks.



Terminals with suffix LS have a standard slotted bolt assembled in the threaded bus bar. This enables faster wiring without the need of two wrenches / spanners.

Width (Thickness) x Length		32 x 75 mm
Height with DIN 35 x 7.5 / 35 x 15 mm Rail		47.5 mm / 54.5 mm
Connection Possibility as per		
With 1 Conductor per clamp	Stranded / Flexible with Ferrule / Lug	
With 2 same size Conductors per clamp	Stranded / Flexible with Ferrule / Lug	
Ratings As Per		
Voltage		1000 V 600 V 600 V
Current		150 A 150 A 150 A
Torque		3.0 Nm 27 lb-in 27 lb-in
Approvals		
Insulation Material / Material Group		Polyamide 6,6 / 1
Rated Impulse Voltage / Pollution Degree		8 KV / 3



CBB35/50 & CBB35/50LS



IEC		UL - CSA	
6 - 50.0 mm ²		10 - 1/0 AWG	
6 - 50.0 mm ²		10 - 1/0 AWG	
IEC60947-1	UL-1059	CSA22.2-158	
1000 V	600 V	600 V	
150 A	150 A	150 A	
3.0 Nm	27 lb-in	27 lb-in	
			
Polyamide 6,6 / 1			
8 KV / 3			

Terminal Block	With Nut & Bolt configuration With Threaded Current Bar	
Partition Plate		
Mounting Rail	(Refer Pg. 217 for details)	
End Clamp	(Refer Pg. 218 for details)	
Marking Tags	(Refer Pg. 222 for details)	
Screw / Bolt Size		

Type / Cat. No.	Standard Pack
CBB35/50	10
CBB35/50LS	10
PPCBB	10
CA701-1M / CA701-1M-S	50 m
CA701-15-1M / CA701-15-1M-S	25 m
CA702 / CA802 / CA202	50
CA509/K10WHT	100
M6	

Jumpers		
Protective Cover for installing on PPCBB & PPCBB1		70 mm
		80 mm
		100 mm
		130 mm
		160 mm
		200 mm
Permanent Jumpers		2 pole
		3 pole

Uninsulated	Imax	Standard Pack
CBBPC1/70		10
CBBPC1/80		10
CTSPC2-1		10
CBBPC1/130		10
CBBPC1/160		10
CBBPC1/200		10
CBBPC1/250		10
CA790/2	150 A	10
CA790/3	150 A	10

Installation instruction:

It is recommended to provide a back support to the wire while tightening the clamping bolt to avoid deformation of the mounting rail or to prevent damage of the Terminal Block by torsional force.

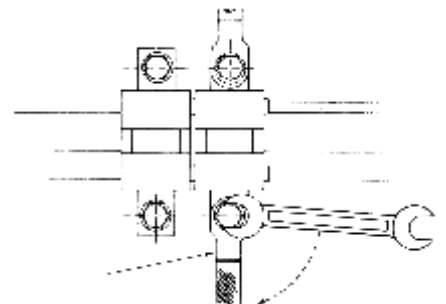

CBB70 & CBB70LS

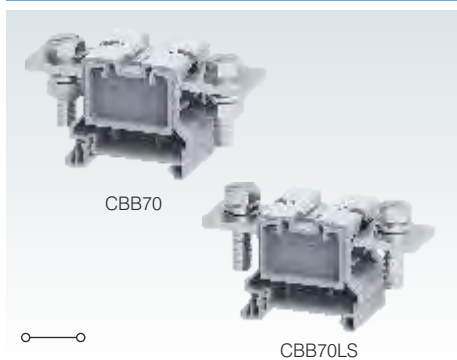

38 x 92 mm		
47.3 mm / 54.5 mm		
IEC	UL - CSA	
6 - 70.0 mm ²	8 - 2/0 AWG	
6 - 70.0 mm ²	8 - 2/0 AWG	
IEC60947-7-1	UL-1059	CSA22.2-158
1000 V	600 V	600 V
192 A	175 A	175 A
6.0 Nm	54 lb-in	54 lb-in
Polyamide 6,6 / 1		
8 KV / 3		

CBB95 & CBB95LS

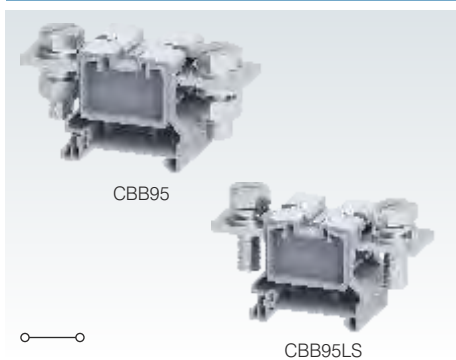

38 x 92 mm		
47.3 mm / 54.5 mm		
IEC	UL - CSA	
16 - 95.0 mm ²	8 - 4/0 AWG	
16 - 95.0 mm ²	8 - 4/0 AWG	
IEC60947-7-1	UL-1059	CSA22.2-158
1000 V	600 V	600 V
232 A	230 A	230 A
10.0 Nm	90 lb-in	90 lb-in
Polyamide 6,6 / 1		
8 KV / 3		

CBB120 & CBB120LS

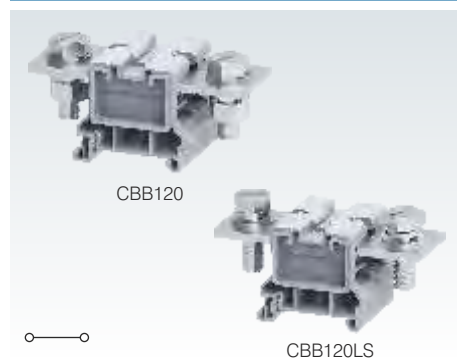

48 x 100 mm		
47.3 mm / 54.5 mm		
IEC	UL - CSA	
16 - 120.0 mm ²	8 - 250 KCMIL	
16 - 120.0 mm ²	8 - 250 KCMIL	
IEC60947-7-1	UL-1059	CSA22.2-158
1000 V	600 V	600 V
269 A	255 A	255 A
10.0 Nm	90 lb-in	90 lb-in
Polyamide 6,6 / 1		
8 KV / 3		

Type / Cat. No.	Standard Pack
CBB70	10
CBB70LS	10
PPCBB	10
CA701-1M / CA701-1M-S	50 m
CA701-15-1M / CA701-15-1M-S	25 m
CA702 / CA802 / CA202	50
CA509/K16WHT	100
M8	

Type / Cat. No.	Standard Pack
CBB95	10
CBB95LS	10
PPCBB1	10
CA701-1M / CA701-1M-S	50 m
CA701-15-1M / CA701-15-1M-S	25 m
CA702 / CA802 / CA202	50
CA509/K16WHT	100
M8	

Type / Cat. No.	Standard Pack
CBB120	10
CBB120LS	10
PPCBB1	10
CA701-1M / CA701-1M-S	50 m
CA701-15-1M / CA701-15-1M-S	25 m
CA702 / CA802 / CA202	50
CA509/K16WHT	100
M10	

Uninsulated	Imax	Standard Pack
CBBPC1/70		10
CBBPC1/80		10
CTSPC2-1		10
CBBPC1/130		10
CBBPC1/160		10
CBBPC1/200		10
CBBPC1/250		10
CA791/2	192 A	10
CA791/3	192 A	10

Uninsulated	Imax	Standard Pack
CBBPC2/100		10
CBBPC2/160		10
CBBPC2/200		10
CBBPC2/250		10
CA791/2	232 A	10
CA791/3	232 A	10

Uninsulated	Imax	Standard Pack
CBBPC2/100		10
CBBPC2/160		10
CBBPC2/200		10
CBBPC2/250		10
CA793/2	269 A	10
CA793/3	269 A	10

POWER TERMINAL BLOCKS

In PTB35/50SH, PTB70/95SH Terminal Blocks a hinged protective cover makes the Terminal Block shock proof (finger safe) and has marker recess to accept marking tag.





The Terminal Blocks can be stacked together by pressing the adjacent Terminal Blocks firmly.

Adjacent terminals can be shorted by removing a thin wall partition and using 2 & 3 pole shorting system.

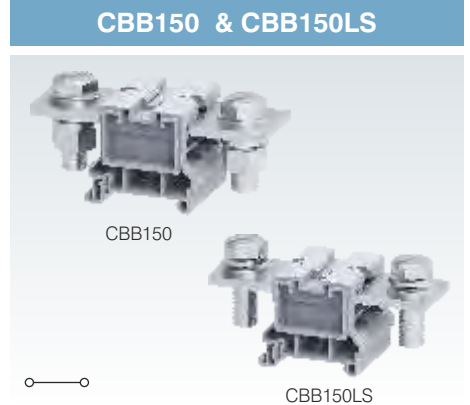
Optional Marker Holder MHPTB35/50 can be used for installing marking tags on the Terminal Blocks without protective covers.

Width (Thickness) x Length	48 x 110 mm		
Height with DIN 35 x 7.5 / 35 x 15 mm Rail	47.3 mm / 54.5 mm		
Connection Possibility as per	IEC		
With 1 Conductor per clamp	Stranded / Flexible with Ferrule / Lug		UL - CSA
With 2 same size Conductors per clamp	Stranded / Flexible with Ferrule / Lug		8 - 300 KCMIL
Ratings As Per	IEC60947-7-1	UL-1059	CSA22.2-158
Voltage	1000 V	600 V	600 V
Current	309 A	285 A	285 A
Torque	14.0 Nm	127 lb-in	127 lb-in
Approvals			
Insulation Material / Material Group	Polyamide 6,6 / 1		
Rated Impulse Voltage / Pollution Degree	8 KV / 3		



		Type / Cat. No.	Standard Pack		
Terminal Block	With Nut & Bolt configuration	CBB150	10		
	With Threaded Current Bar With Integral Shroud	CBB150LS	10		
Partition Plate / Protective Shroud		PPCBB1	10		
Mounting Rail (Refer Pg. 217 for details)		CA701-1M / CA701-1M-S	50 m		
		CA701-15-1M / CA701-15-1M-S	25 m		
End Clamp (Refer Pg. 218 for details)		CA702 / CA802 / CA202	50		
Marking Tags (Refer Pg. 222 for details)		CA509/K16WHT	100		
Marker Holder					
Screw / Bolt Size		M12			
Jumpers		Uninsulated	Imax	Standard Pack	
Protective Cover for installing on PPCBB & PPCBB1		100 mm	CBBPC2/100	10	
		160 mm	CBBPC2/160	10	
		200 mm	CBBPC2/200	10	
		250 mm	CBBPC2/250	10	
Permanent Jumpers		2 pole	CA794/2	309 A	10
		3 pole	CA794/3	309 A	10

Installation instruction:

It is recommended to provide a back support to the wire while tightening the clamping bolt to avoid deformation of the mounting rail or to prevent damage of the Terminal Block by torsional force.

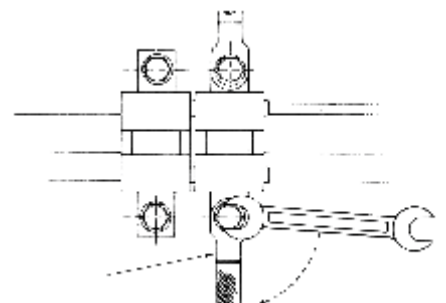

CBB185 & CBB185LS

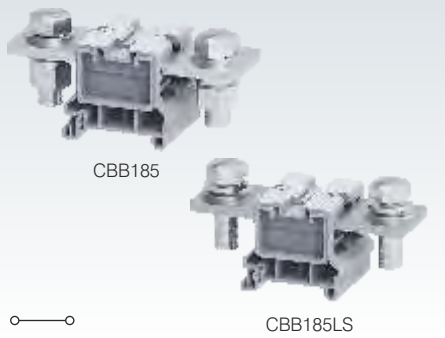

48 x 110 mm
47.3 mm / 54.5 mm

IEC	UL - CSA
16 - 185.0 mm ²	8 - 350 KCMIL
16 - 185.0 mm ²	8 - 350 KCMIL

IEC60947-7-1	UL-1059	CSA22.2-158	
1000 V	600 V	600 V	
353 A	310 A	310 A	
14.0 Nm	127 lb-in	127 lb-in	
Polyamide 6,6 / 1			
8 KV / 3			

PTB35/50 & PTB35/50SH

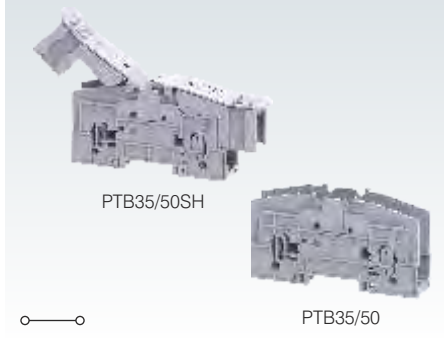

25 x 113 mm / 169 mm (with Shroud)
61.0 mm / 68.3 mm
66.5 mm / 73.6 mm

IEC	UL - CSA
1.5 - 50.0 mm ²	8 - 2 AWG
1.5 - 50.0 mm ²	8 - 2 AWG

IEC60947-7-1	UL-1059	CSA22.2-158	IEC60079-7
1000 V	600 V	600 V	1100 V
150 A	115 A	115 A	126 A
3.0 Nm	27 lb-in	27 lb-in	3.0 Nm
Polyamide 6,6 / 1			
8 KV / 3			

PTB70/95 & PTB70/95SH

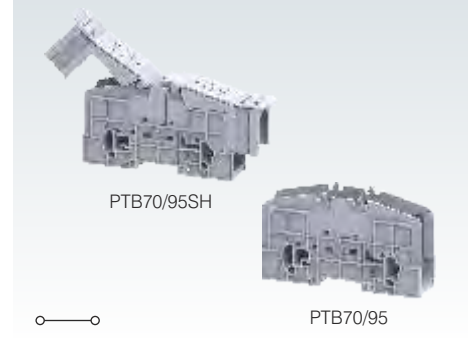

32 x 130 mm / 192 mm (with Shroud)
76.6 mm / 84.5 mm
78 mm / 86 mm

IEC	UL - CSA
1.5 - 95.0 mm ²	8 - 4/0 AWG
1.5 - 95.0 mm ²	8 - 4/0 AWG

IEC60947-7-1	UL-1059	CSA22.2-158	
1000 V	600 V	600 V	
232 A	230 A	230 A	
10.0 Nm	87 lb-in	87 lb-in	
Polyamide 6,6 / 1			
8 KV / 3			

Type / Cat. No.	Standard Pack	
CBB185	10	
CBB185LS	10	
PPCBB1	10	
CA701-1M / CA701-1M-S	50 m	
CA701-15-1M / CA701-15-1M-S	25 m	
CA702 / CA802 / CA202	50	
CA509/K16WHT	100	
M12		
Uninsulated	Imax	Standard Pack
CBBPC2/100		10
CBBPC2/160		10
CBBPC2/200		10
CBBPC2/250		10
CA794/2	353 A	10
CA794/3	353 A	10

Type / Cat. No.	Standard Pack	
PTB35/50	10	
PTB35/50SH	10	
PSPTB35/50	20	
CA701-1M / CA701-1M-S	50 m	
CA701-15-1M / CA701-15-1M-S	25 m	
CA202 / CA102	50	
CA509/K9WHT	100	
MHPTB35/50	10	
M6		
Uninsulated	Imax	Standard Pack
CA703/9	150 A	10
CA704/9	150 A	10

Type / Cat. No.	Standard Pack	
PTB70/95	10	
PTB70/95SH	10	
CA701-1M / CA701-1M-S	50 m	
CA701-15-1M / CA701-15-1M-S	25 m	
CA202 / CA102	50	
CA509/K9WHT	100	
MHPTB70/95	10	
M8		
Uninsulated	Imax	Standard Pack
CA703/11	220 A	10
CA704/11	220 A	10

* M3 Screw of desired length with nut can be used optionally to secure the stack.

PTB35 with optional MHPTB35

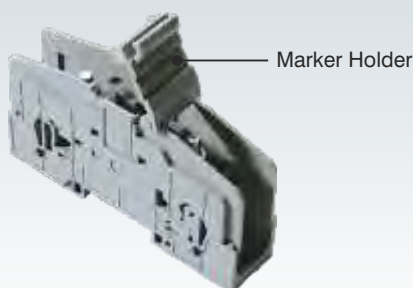

Panel Mounting Hole Details

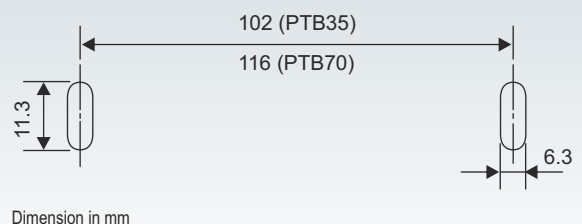

POWER TERMINAL BLOCKS

PTB120/150 & PTB120/150SH

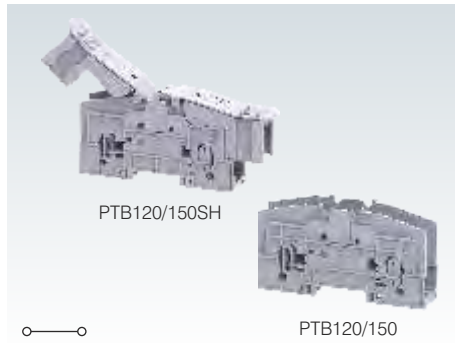

Width (Thickness) x Length	42 x 124 mm / 186 mm (with Shroud)		
Height with DIN 35 x 7.5 / 35 x 15 mm Rail	72.3 mm / 79.8 mm		
	73.8 mm / 83.3 mm		
Connection Possibility as per	IEC	UL - CSA	
With 1 Conductor per clamp	Stranded / Flexible with Ferrule / Lug	6.0 - 150.0 mm ²	8 - 300 KCMIL
With 2 same size Conductors per clamp	Stranded / Flexible with Ferrule / Lug	6.0 - 150.0 mm ²	8 - 300 KCMIL
Ratings As Per	IEC60947-7-1	UL-1059	CSA22.2-158
Voltage	1000 V	600 V	600 V
Current	310 A	285 A	285 A
Torque	10.0 Nm	127 lb-in	127 lb-in
Approvals	CE		
Insulation Material / Material Group	Polyamide 6,6 / 1		
Rated Impulse Voltage / Pollution Degree	8 KV / 3		

	Type / Cat. No.	Standard Pack
Terminal Block	PTB120/150	10
	PTB120/150SH	10
Protective Cover	PSPTB120/150	20
Mounting Rail (Refer Pg. 217 for details)	CA701-1M / CA701-1M-S	50 m
	CA701-15-1M / CA701-15-1M-S	25 m
End Clamp (Refer Pg. 218 for details)	CA202 / CA102	50
Marking Tags (Refer Pg. 222 for details)	CA509/K9WHT	100
Bolt Size	M10	

	Uninsulated	Imax	Standard Pack
Shorting System	2 pole	CA703/12	300 A
	3 pole	CA704/12	300 A

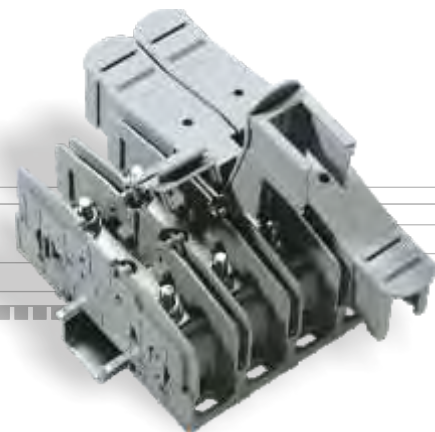

MELAMINE TERMINAL BLOCKS

High Grade Melamine Terminal Blocks are suitable for applications involving high temperature. Connections can be made by simply stripping the wire of its insulation to the recommended length and clamping it without any additional preparation. In no instance does the clamping screw act directly on the wire and this effectively prevents damage to the wire.



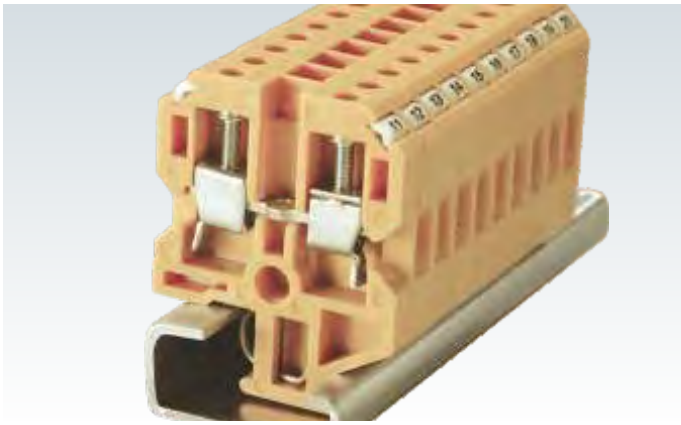

Screw Clamp Terminal Blocks with a high torque clamping system ensuring safe, gas tight connections. Cold forged, rolled threaded screws ensure highly reliable connections.

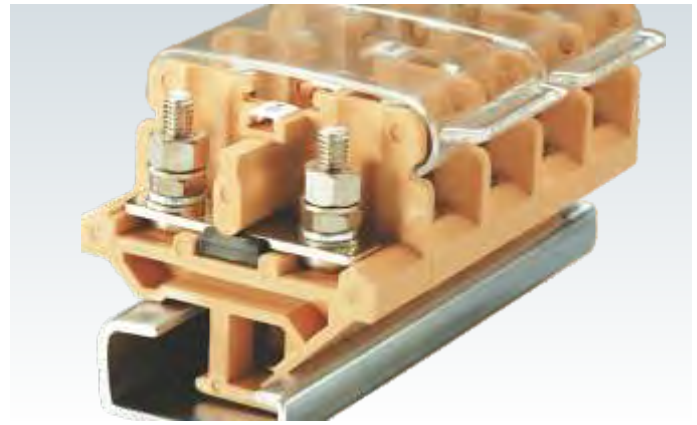

High Torque clamping system for ring & fork type lugs / ferrules. Extremely effective clamping system for areas prone to high vibrations.

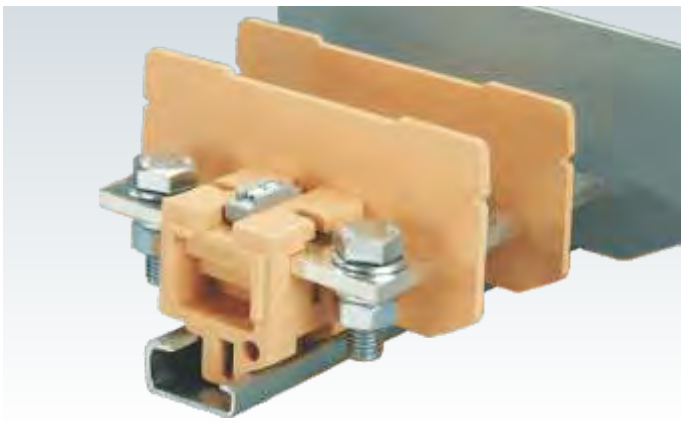

High current terminal blocks provide extremely reliable connection for higher size wires. Additional isolation plates are used to make these assemblies safe.

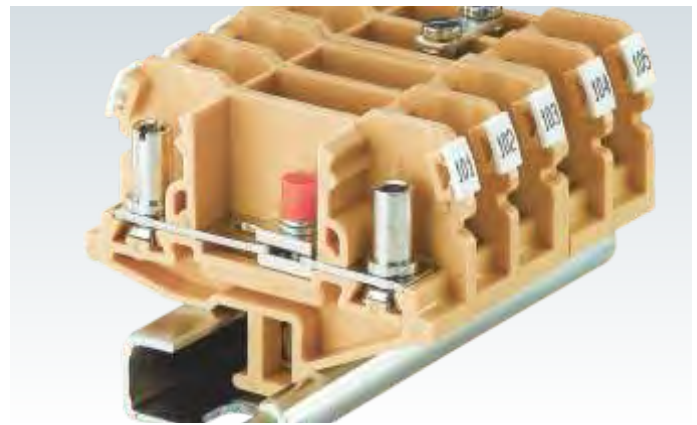

Disconnecting Terminal Block system is a versatile wire connection method for current transformer and power meters. A wide range of accessories eases the testing of these instruments.

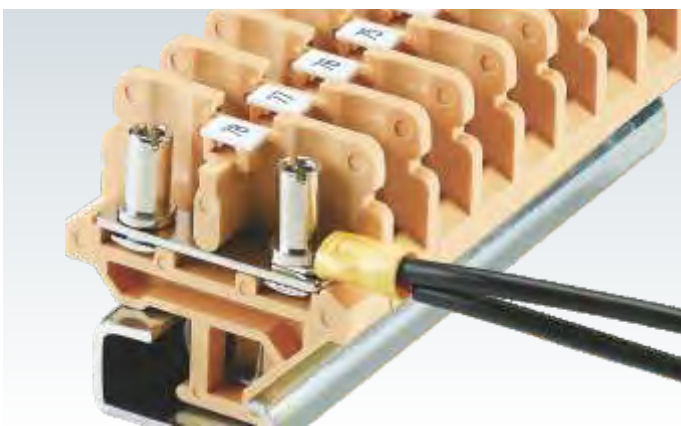

Commercially available ring or fork type lugs / ferrules can be used for terminating multiple wires. The bolt & nut system make these multi wire connections safe and secure.

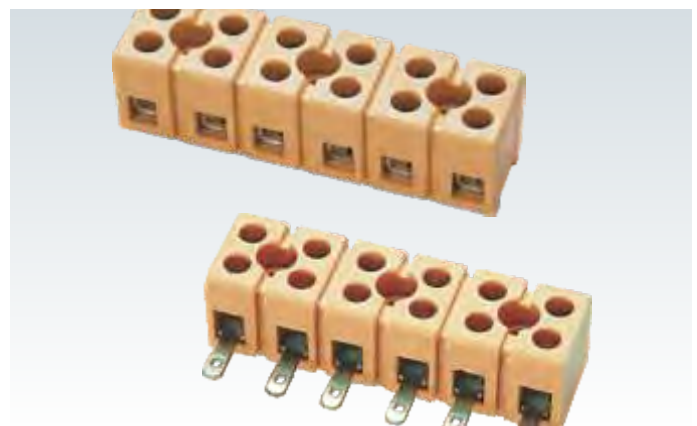

Strip type terminals are used for electric and electronic equipments and smaller junction boxes. They can be cut to different pole configurations.

MELAMINE TERMINAL BLOCKS

**Feed Through****197 - 199****Stud Type****200 - 204****Disconnect & Test****205 - 206****Bus Bar****207 - 208****Spring Loaded****209 - 210****Multipole Strip****211 - 212****Ceramic Terminal****213 - 214**

STANDARD FEED THROUGH TERMINAL BLOCKS

These Terminal Blocks are ideal choice for use in High Temperature applications. These Terminal Blocks can be mounted on a standard 'G' rail and are available for wire sizes from 0.2 to 35 sq.mm

These Terminal Blocks have marker holding recesses to accept marking tags for circuit identification. Cross connection can be achieved with the aid of jumpers / sleeves & screws. The specially designed 'Knock Out' at the center must be removed to facilitate permanent shorting.

Width (Thickness) x Length		6 x 36.5 mm	
Height with DIN 32 x 15 mm Rail		46.5 mm	
Connection Possibility as per		IEC	UL - CSA
With 1 Conductor per clamp	Stranded / Flexible	0.2 - 2.5 mm ²	22 - 12 AWG
	Solid	0.2 - 4.0 mm ²	22 - 10 AWG
	with Ferrule / Lug	0.2 - 2.5 mm ²	22 - 12 AWG
With 2 same size Conductors per clamp	Stranded / Flexible	0.2 - 1.5 mm ²	22 - 14 AWG
	with TWIN Ferrule / Lug	0.2 - 1.5 mm ²	22 - 16 AWG
Wire Stripping Length		9 mm	
Ratings As Per		IEC60947-7-1 CSA22.2-158	
Voltage		800 V	600 V
Current		24 A	25 A
Torque		0.4 Nm	7 lb-in
Approvals			
Insulation Material / Comparative Tracking Index		Melamine / 1	
Rated Impulse Voltage / Pollution Degree		8 KV / 3	
		Type / Cat. No.	Standard Pack
Terminal Block		CTS2.5M	200
	Blue	CTS2.5MBU	200
	Red	CTS2.5MR	200
	Yellow	CTS2.5MY	200
	Black	CTS2.5MBK	200
End Plate		CTSEP01	50
Partition Plate		CTSP01	50
Mounting Rail (Refer Pg. 217 for details)		CA501-1M / CA501-1M-S	25 m
End Clamp (Refer Pg. 218 for details)		CA502 / CA702	50
Marking Tags (Refer Pg. 222 for details)		CA509/K2WHT	100
Screw Driver		SCS0.5/3	Blade size: 0.5 x 3 mm 10



Jumpers		Uninsulated	Insulated	I _{max}	Standard Pack
Screw Type Jumpers		CA521/2	CA621/2	24 A	100
		CA521/3	CA621/3	24 A	100
		CA521/4	CA621/4	24 A	100
		CA521/10	CA621/10	24 A	10
Jumper Bar		CA503/01		24 A	100
		CA504/01		24 A	100
		CA505/01		24 A	100
		CA510/10		24 A	100
Short Sleeve & Screw for configurable jumper bar		CA507/S/Q/01			50
Short Stud & Screw for configurable jumper bar		CA507/S/01			100
Switchable Jumper		CA506/01		24 A	100
Long Sleeve & Screw for Switchable Jumpers		CA507/L/Q/01			100
Long Stud & Screw for Switchable Jumpers		CA507/L/01			100
Test Socket		CA707/TS/04			100

CTS2.5



6.7 x 40 mm

52 mm

IEC	UL - CSA
0.2 - 4.0 mm ²	22 - 10 AWG
0.2 - 6.0 mm ²	
0.2 - 4.0 mm ²	22 - 10 AWG
0.2 - 2.5 mm ²	22 - 12 AWG
0.2 - 2.5 mm ²	22 - 12 AWG

12 mm

IEC60947-7-1 CSA22.2-158

800 V	600 V		
32 A	40 A*		
0.5 Nm	7 lb-in		



Melamine / 1

8 KV / 3

Type / Cat. No.	Standard Pack
CTS2.5	200
CTS2.5BU	200
CTS2.5R	200
CTS2.5Y	200
CTS2.5BK	200
CTSEP1	50
CTSP1L	50
CTSP1B	50
CA501-1M / CA501-1M-S	25 m
CA502 / CA702	50
CA509/K2WHT	100
SCS0.6/3.5 Blade size: 0.6 x 3.5 mm	10

CTS6



8 x 40 mm

52 mm

IEC	UL - CSA
1.5 - 6.0 mm ²	22 - 8 AWG
1.5 - 6.0 mm ²	
1.5 - 6.0 mm ²	22 - 8 AWG
1.5 - 4.0 mm ²	22 - 10 AWG
1.5 - 4.0 mm ²	22 - 10 AWG

10 mm

IEC60947-7-1 CSA22.2-158

1000 V	600 V		
41 A	50 A		
0.8 Nm	14 lb-in		



Melamine / 1

Type / Cat. No.	Standard Pack
CTS6	200
CTS6BU	200
CTS6R	200
CTS6Y	200
CTS6BK	200
CTSEP1	50
CTSP1L	50
CTSP1B	50
CA501-1M / CA501-1M-S	25 m
CA502 / CA702	50
CA509/K2WHT	100
SCS0.8/4 Blade size: 0.8 x 4 mm	10

CTS10



10 x 40 mm

52 mm

IEC	UL - CSA
1.5 - 10.0 mm ²	22 - 6 AWG
1.5 - 10.0 mm ²	
1.5 - 10.0 mm ²	22 - 6 AWG
1.5 - 6.0 mm ²	22 - 8 AWG
1.5 - 6.0 mm ²	22 - 10 AWG

12 mm

IEC60947-7-1 CSA22.2-158

1000 V	600 V		
57 A	65 A		
1.2 Nm	14 lb-in		



Melamine / 1

8 KV / 3

Type / Cat. No.	Standard Pack
CTS10	200
CTS10BU	200
CTS10R	200
CTS10Y	200
CTS10BK	200
CTSEP1	50
CTSP1L	50
CTSP1B	50
CA501-1M / CA501-1M-S	25 m
CA502 / CA702	50
CA509/K2WHT	100
SCS0.8/4 Blade size: 0.8 x 4 mm	10

Uninsulated	Insulated	I _{max}	Standard Pack
CA522/2	CA622/2	32 A	100
CA522/3	CA622/3	32 A	100
CA522/4	CA622/4	32 A	100
CA522/10	CA622/10	32 A	10
CA503/1		32 A	100
CA504/1		32 A	100
CA505/1		32 A	100
CA510/1		32 A	100
CA507/S/Q/01			50
CA507/S/01			100
CA506/01		24 A	100
CA507/L/Q/01			100
CA507/L/01			100
CA707/TS/04			100

Uninsulated	Insulated	I _{max}	Standard Pack
CA723/2	CA743/2	41 A	100
CA723/3	CA743/3	41 A	100
CA723/4	CA743/4	41 A	100
CA723/10	CA743/10	41 A	10
CA703/2		41 A	100
CA704/2		41 A	100
CA705/2		41 A	100
CA733/10		41 A	100
CA707/S/Q/1			100
CA507/S/1			100
CA706/2		41 A	100
CA707/L/Q/1			100
CA507/L/1			100
CA707/TS/05			100

Uninsulated	Insulated	I _{max}	Standard Pack
CA724/2	CA744/2	57 A	100
CA724/3	CA744/3	57 A	100
CA724/4	CA744/4	57 A	100
CA724/10	CA744/10	57 A	10
CA703/3		57 A	100
CA704/3		57 A	100
CA705/3		57 A	100
CA734/10		57 A	100
CA707/S/Q/1			100
CA507/S/2			100
CA706/3		24 A	100
CA707/L/Q/1			100
CA507/L/2			100
CA707/TS/05			100

* 40 Amp with two 12 AWG wires
35 Amp with one 10 AWG wire

STANDARD FEED THROUGH TERMINAL BLOCKS

CTS16

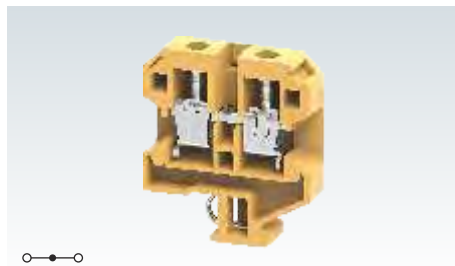

CTS35

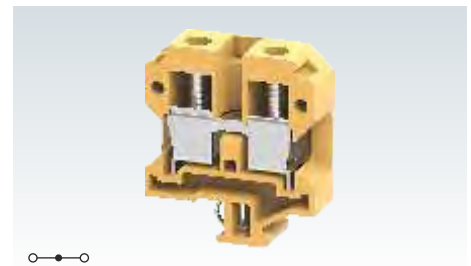

Width (Thickness) x Length	12 x 50 mm				18 x 58 mm			
Height with DIN 32 x 15 mm Rail	57.5 mm				66.8 mm			
Connection Possibility as per	IEC	UL - CSA		IEC	UL - CSA			
		With 1 Conductor per clamp	Stranded / Flexible		6.0 - 16.0 mm ²	20 - 4 AWG		
		with Ferrule / Lug						
With 2 same size Conductors per clamp	IEC	UL - CSA		IEC	UL - CSA			
		Stranded / Flexible	6.0 - 10.0 mm ²		20 - 8 AWG	10.0 - 16.0 mm ²		
		with TWIN Ferrule / Lug						
Wire Stripping Length	14 mm				20 mm			
Ratings As Per	IEC60947-7-1 CSA22.2-158				IEC60947-7-1 CSA22.2-158			
Voltage	1000 V	600 V		1100 V	600 V			
	Current	76 A	85 A	125 A	145 A			
Torque	1.2 Nm	14 lb-in		2.5 Nm	25 lb-in			
	Approvals				Approvals			
Insulation Material / Comparative Tracking Index	Melamine / 1				Melamine / 1			
Rated Impulse Voltage / Pollution Degree	8 KV / 3				8 KV / 3			

	Type / Cat. No.	Standard Pack	Type / Cat. No.	Standard Pack
Terminal Block	CTS16	100	CTS35	50
	Blue CTS16BU	100	CTS35BU	50
	Red CTS16R	100	CTS35R	50
	Yellow CTS16Y	100	CTS35Y	50
	Black CTS16BK	100	CTS35BK	50
End Plate	CTSEP2	50	CTSEP3	25
Partition Plate	CTSP2	50	CTSP3	25
Mounting Rail (Refer Pg. 217 for details)	CA501-1M / CA501-1M-S	25 m	CA501-1M / CA501-1M-S	25 m
End Clamp (Refer Pg. 218 for details)	CA502 / CA702	50	CA502 / CA702	50
Marking Tags (Refer Pg. 222 for details)	CA509/K2WHT	100	CA509/K2WHT	100
Screw Driver	SCS0.8/4 Blade size: 0.8 x 4 mm	10	SCS1.0/5.5 Blade size: 1.0 x 5.5 mm	10

Jumpers	Uninsulated	Insulated	I _{max}	Standard Pack	Uninsulated	Insulated	I _{max}	Standard Pack
Screw Type Jumpers	2 pole	CA751/2	CA761/2	65 A	50			
	3 pole	CA751/3	CA761/3	65 A	50			
	4 pole	CA751/4	CA761/4	65 A	50			
	10 pole	CA751/10	CA761/10	65 A	10			
Jumper Bar	2 pole	CA703/8		65 A	100	CA503/5	125 A	100
	3 pole	CA704/8		65 A	100	CA504/5	125 A	100
	4 pole	CA705/8		65 A	100	CA505/5	125 A	100
	10 pole	CA739/10		65 A	100	CA510/5	125 A	100
Short Sleeve & Screw for configurable jumper bar	CA507/S/Q1			100	CA508/S/Q		100	
Short Stud & Screw for configurable jumper bar	CA507/S/2			100	CA508/S		100	
Switchable Jumper	CA706/8		65 A	100	CA506/5	125 A	100	
Long Sleeve & Screw for Switchable Jumpers	CA707/L/Q1			100	CA508/L/Q		100	
Long Stud & Screw for Switchable Jumpers	CA507/L/2			100	CA508/L		100	
Test Socket	CA707/TS/05			100	CA707/TS/06		100	

STUD TYPE TERMINAL BLOCKS

These Terminal Blocks are preferred for applications where the connections are subjected to severe vibrations.

The wire is crimped to a ring / fork type lug (ferrule) and is screwed on to the flat current bar on the Terminal Block. The range includes Terminal Blocks for wire sizes from 0.25 to 35sq.mm.

Cross connection can be achieved with the aid of external jumpers.

It is recommended to use protective covers in transparent plastic to fully shroud these assemblies.

CSTSB3

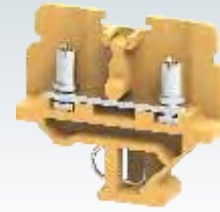

Width (Thickness) x Length	10 x 50 mm		
Height with DIN 32 x 15 mm Rail	47.5 mm		
Connection Possibility as per	IEC	UL - CSA	
With 1 Conductor per clamp	Stranded / Flexible with Ferrule / Lug	1.5 - 6.0 mm ²	22 - 10 AWG
	Solid with Ferrule / Lug	1.5 - 6.0 mm ²	
With 2 same size Conductors per clamp	Stranded / Flexible with Ferrule / Lug	1.5 - 2.5 mm ²	22 - 12 AWG
Wire Stripping Length	9 mm		
Ratings As Per	IEC60947-7-1 CSA22.2-158		
Voltage	1100 V	600 V	
Current	41 A	35 A	
Torque	0.5 Nm	7 lb-in	
Approvals			
Insulation Material / Comparative Tracking Index	Melamine / 1		
Rated Impulse Voltage / Pollution Degree	8 KV / 3		

	Type / Cat. No.	Standard Pack
Terminal Block	CSTSB3	100
	CSTSB3BU	100
	CSTSB3R	100
	CSTSB3Y	100
	CSTSB3BK	100
End Plate	CSTSEP2	50
Partition Plate	CSTSPPP	50
Mounting Rail (Refer Pg. 217 for details)	CA501-1M / CA501-1M-S	25 m
End Clamp (Refer Pg. 218 for details)	CA502 / CA702	50
Marking Tags (Refer Pg. 222 for details)	CA509/K2B4WHT	100
Screw Driver	SCS0.8/4 Blade size: 0.8 x 4 mm	10
Stud Size		

	Type / Cat. No.	I _{max}	Standard Pack
Uninsulated Removable Jumper	2 pole	32 A	100
	3 pole	32 A	50
	4 pole	32 A	50
Insulated Removable Jumper	2 pole	32 A	100
	3 pole	32 A	50
	4 pole	32 A	50
Permanent Uninsulated Jumper	2 pole	32 A	100
	3 pole	32 A	50
	4 pole	32 A	50
Permanent Insulated Jumper	2 pole	32 A	100
	3 pole	32 A	50
	4 pole	32 A	50
Protective Cover	2 Terminal		100
	3 Terminal		100
Long Protective Cover	100 mm		10
	200 mm		10
	300 mm		10

STUD TYPE TERMINAL BLOCKS

CSTSB4/N4



CSTSB5



Width (Thickness) x Length	13 x 45.0 mm		13 x 50 mm	
Height with DIN 32 x 15 mm Rail	45.0 mm		47.5 mm	
Connection Possibility as per	IEC	UL - CSA	IEC	UL - CSA
With 1 Conductor per clamp	Stranded / Flexible with Ferrule / Lug	1.5 - 10.0 mm ²	22 - 6 AWG	1.5 - 16.0 mm ²
	Solid with Ferrule / Lug			22 - 4 AWG
With 2 same size Conductors per clamp	Stranded / Flexible with Ferrule / Lug	1.5 - 10.0 mm ²	22 - 6 AWG	1.5 - 6.0 mm ²
				22 - 8 AWG
Wire Stripping Length	12 mm		12 mm	
Ratings As Per	IEC60947-7-1		IEC60947-7-1 CSA22.2-158	
Voltage	1100 V		1000 V	600 V
Current	57 A		76 A	80 A
Torque	1.2 Nm		2.0 Nm	25 lb-in
Approvals	CE		IECEE CE C-SP US	
Insulation Material / Comparative Tracking Index	Melamine / 1		Melamine / 1	
Rated Impulse Voltage / Pollution Degree	8 KV / 3		8 KV / 3	

	Type / Cat. No.	Standard Pack	Type / Cat. No.	Standard Pack
Terminal Block	CSTSB4/N4	100	CSTSB5	100
	Blue CSTSB4/N4BU	100	CSTSB5BU	100
	Red CSTSB4/N4R	100	CSTSB5R	100
	Yellow CSTSB4/N4Y	100	CSTSB5Y	100
	Black CSTSB4/N4BK	100	CSTSB5BK	100
End Plate	EPCSTSB4/N4	50	CSTSEP2	50
Partition Plate			CSTSPPP	50
Mounting Rail (Refer Pg. 217 for details)	CA501-1M / CA501-1M-S	25 m	CA501-1M / CA501-1M-S	25 m
End Clamp (Refer Pg. 218 for details)	CA502 / CA702	50	CA502 / CA702	50
Marking Tags (Refer Pg. 222 for details)	CA509/K2B4WHT	100	CA509/K2B4WHT	100
Screw Driver	SCS1.0/5.5 Blade size: 1.0 x 5.5 mm	10	SCS1.0/5.5 Blade size: 1.0 x 5.5 mm	10
Stud Size	M4			

	Type / Cat. No.	I _{max}	Standard Pack	Type / Cat. No.	I _{max}	Standard Pack
Uninsulated Removable Jumper	2 pole CA512/2-2	45 A	100	CA512/2-2	45 A	100
	3 pole CA512/2-3	45 A	50	CA512/2-3	45 A	50
	4 pole CA512/2-4	45 A	50	CA512/2-4	45 A	50
Insulated Removable Jumper	2 pole CA514/2-2	45 A	100	CA514/2-2	45 A	100
	3 pole CA514/2-3	45 A	50	CA514/2-3	45 A	50
	4 pole CA514/2-4	45 A	50	CA514/2-4	45 A	50
Permanent Uninsulated Jumper	2 pole CA512/4-2	45 A	100	CA512/4-2	45 A	100
	3 pole CA512/4-3	45 A	50	CA512/4-3	45 A	50
	4 pole CA512/4-4	45 A	50	CA512/4-4	45 A	50
Permanent Insulated Jumper	2 pole CA514/4-2	45 A	100	CA514/4-2	45 A	100
	3 pole CA514/4-3	45 A	50	CA514/4-3	45 A	50
	4 pole CA514/4-4	45 A	50	CA514/4-4	45 A	50
Protective Cover	2 Terminal CSTSPC2			CSTSPC2		100
	3 Terminal CSTSPC2-1			CSTSPC2-1		100
Long Protective Cover	100 mm CSTSPC1-5		10	CSTSPC1-2		10
	200 mm CSTSPC1-6		10	CSTSPC1-3		10
	300 mm CSTSPC1-7		10	CSTSPC1-4		10

CSTSN4



17 x 50 mm

47.5 mm

IEC	UL - CSA
1.5 - 10.0 mm ²	22 - 6 AWG

1.5 - 6.0 mm ²	22 - 8 AWG
---------------------------	------------

12 mm

IEC60947-7-1 CSA22.2-158

1100 V	600 V		
57 A	65 A		
1.2 Nm	14 lb-in		



Melamine / 1

8 KV / 3

Type / Cat. No.	Standard Pack
CSTSN4	100
CSTSN4BU	100
CSTSN4R	100
CSTSN4Y	100
CSTSN4BK	100
CSTSEP2	50
CSTSP	50
CA501-1M / CA501-1M-S	25 m
CA502 / CA702	50
CA509/K2B4WHT	100

CSTSN415

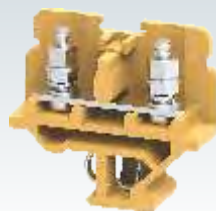

15 x 50 mm

47.5 mm

IEC	UL - CSA
1.5 - 10.0 mm ²	22 - 6 AWG

1.5 - 6.0 mm ²	22 - 8 AWG
---------------------------	------------

12 mm

IEC60947-7-1 CSA22.2-158

1000 V	600 V		
57 A	65 A		
1.2 Nm	14 lb-in		



Melamine / 1

8 KV / 3

Type / Cat. No.	Standard Pack
CSTSN415	100
CSTSN415BU	100
CSTSN415R	100
CSTSN415Y	100
CSTSN415BK	100
CSTSEP2	50
CSTSP	50
CA501-1M / CA501-1M-S	25 m
CA502 / CA702	50
CA509/K2B4WHT	100

Type / Cat. No.	I _{max}	Standard Pack
CA512/1-2	45 A	100
CA512/1-3	45 A	50
CA512/1-4	45 A	50
CA514/1-2	45 A	100
CA514/1-3	45 A	50
CA514/1-4	45 A	50
CA512/3-2	45 A	100
CA512/3-3	45 A	50
CA512/3-4	45 A	50
CA514/3-2	45 A	100
CA514/3-3	45 A	50
CA514/3-4	45 A	50
CSTSPC1		100
CSTSPC1-1		100
CSTSPC1-2		10
CSTSPC1-3		10
CSTSPC1-4		10

Type / Cat. No.	I _{max}	Standard Pack
CA512/9-2	45 A	100
CA512/9-3	45 A	50
CA512/9-4	45 A	50
CA514/9-2	45 A	100
CA514/9-3	45 A	50
CA514/9-4	45 A	50
CA512/10-2	45 A	100
CA512/10-3	45 A	50
CA512/10-4	45 A	50
CA514/10-2	45 A	100
CA514/10-3	45 A	50
CA514/10-4	45 A	50
CSTSPC1		100
CSTSPC1-1		100
CSTSPC1-2		10
CSTSPC1-3		10
CSTSPC1-4		10

STUD TYPE TERMINAL BLOCKS

CSTSN5

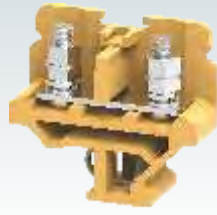

CSTSN515



Width (Thickness) x Length	17 x 50 mm		15 x 50 mm	
Height with DIN 32 x 15 mm Rail	47.5 mm		47.5 mm	
Connection Possibility as per	IEC	UL - CSA	IEC	UL - CSA
With 1 Conductor per clamp	Stranded / Flexible with Ferrule / Lug	1.5 - 16.0 mm ²	22 - 4 AWG	1.5 - 16.0 mm ²
With 2 same size Conductors per clamp	Solid with Ferrule / Lug	1.5 - 6.0 mm ²	22 - 8 AWG	1.5 - 6.0 mm ²
Wire Stripping Length	12 mm		12 mm	
Ratings As Per	IEC60947-7-1 CSA22.2-158		IEC60947-7-1 CSA22.2-158	
Voltage	1100 V	600 V	1000 V	600 V
Current	76 A	80 A	76 A	80 A
Torque	2.0 Nm	25 lb-in	2.0 Nm	25 lb-in
Approvals				
Insulation Material / Comparative Tracking Index	Melamine / 1		Melamine / 1	
Rated Impulse Voltage / Pollution Degree	8 KV / 3		8 KV / 3	

	Type / Cat. No.	Standard Pack	Type / Cat. No.	Standard Pack
Terminal Block	CSTSN5	100	CSTSN515	100
	Blue CSTSN5BU	100	CSTSN515BU	100
	Red CSTSN5R	100	CSTSN515R	100
	Yellow CSTSN5Y	100	CSTSN515Y	100
	Black CSTSN5BK	100	CSTSN515BK	100
End Plate	CSTSEP2	50	CSTSEP2	50
Partition Plate	CSTSP	50	CSTSP	50
Mounting Rail (Refer Pg. 217 for details)	CA501-1M / CA501-1M-S	25 m	CA501-1M / CA501-1M-S	25 m
End Clamp (Refer Pg. 218 for details)	CA502 / CA702	50	CA502 / CA702	50
Marking Tags (Refer Pg. 222 for details)	CA509/K2B4WHT	100	CA509/K2B4WHT	100
Stud Size	M5		M5	
Marker Mounting Carrier				

	Type / Cat. No.	I _{max}	Standard Pack	Type / Cat. No.	I _{max}	Standard Pack
Uninsulated Removable Jumper	2 pole CA512/1-2	45 A	100	CA512/9-2	45 A	100
	3 pole CA512/1-3	45 A	50	CA512/9-3	45 A	50
	4 pole CA512/1-4	45 A	50	CA512/9-4	45 A	50
Insulated Removable Jumper	2 pole CA514/1-2	45 A	100	CA514/9-2	45 A	100
	3 pole CA514/1-3	45 A	50	CA514/9-3	45 A	50
	4 pole CA514/1-4	45 A	50	CA514/9-4	45 A	50
Permanent Uninsulated Jumper	2 pole CA512/3-2	45 A	100	CA512/10-2	45 A	100
	3 pole CA512/3-3	45 A	50	CA512/10-3	45 A	50
	4 pole CA512/3-4	45 A	50	CA512/10-4	45 A	50
Permanent Insulated Jumper	2 pole CA514/3-2	45 A	100	CA514/10-2	45 A	100
	3 pole CA514/3-3	45 A	50	CA514/10-3	45 A	50
	4 pole CA514/3-4	45 A	50	CA514/10-4	45 A	50
Protective Cover	2 Terminal CSTSPC1		100	CSTSPC4		100
	3 Terminal CSTSPC1-1		100	CSTSPC4-1		100
Long Protective Cover	90 mm CSTSPC1-2		10	CSTSPC1-2		10
	100 mm CSTSPC1-3		10	CSTSPC1-3		10
	150 mm CSTSPC1-4		10	CSTSPC1-4		10
	200 mm CSTSPC1-4		10	CSTSPC1-4		10
Protective Cover Holder	CSP1		100	CSP1		100

CSTSN6



17 x 50 mm	
47.5 mm	
IEC	UL - CSA
1.5 - 35.0 mm ²	22 - 2 AWG

1.5 - 16.0 mm² 22 - 4 AWG

12 mm

IEC60947-7-1 CSA22.2-158

1000 V	600 V		
125 A	125 A		
3.0 Nm	27 lb-in		



Melamine / 1
8 KV / 3

Type / Cat. No.	Standard Pack
CSTSN6	100
CSTSN6BU	100
CSTSN6R	100
CSTSN6Y	100
CSTSN6BK	100
CSTSEP2	50
CSTSPP	50
CA501-1M / CA501-1M-S	25 m
CA502 / CA702	50
CA509/K2B4WHT	100
M6	

Type / Cat. No.	I _{max}	Standard Pack
CA512/7-2	50 A	100
CA512/7-3	50 A	50
CA512/7-4	50 A	50
CA514/7-2	50 A	100
CA514/7-3	50 A	50
CA514/7-4	50 A	50
CA512/8-2	50 A	100
CA512/8-3	50 A	50
CA512/8-4	50 A	50
CA514/8-2	50 A	100
CA514/8-3	50 A	50
CA514/8-4	50 A	50
CSTSPC1		100
CSTSPC1-1		100
CSTSPC1-2		10
CSTSPC1-3		10
CSTSPC1-4		10

CSTSRN5



26 x 43 mm	
53.5 mm	
IEC	UL - CSA
1.5 - 16.0 mm ²	22 - 4 AWG

1.5 - 16.0 mm² 22 - 4 AWG

16 mm

IEC60947-7-1 CSA22.2-158

1100 V	600 V		
76 A	85 A		
2.0 Nm	25 lb-in		



Melamine / 1
8 KV / 3

Type / Cat. No.	Standard Pack
CSTSRN5	50
CSTSRN5BU	50
CSTSRN5R	50
CSTSRN5Y	50
CSTSRN5BK	50
CSTSREP	50
CA501-1M / CA501-1M-S	25 m
CA502 / CA702	50
CA509/K2B4WHT	100
M6	
MACKRN5	

Type / Cat. No.	I _{max}	Standard Pack
CA512/11-2	125 A	50
CA514/11-2	125 A	50
CA512/12-2	125 A	50
CA514/12-2	125 A	50
CSTSPC1		100
CSTSPC1-1		100
CTSPC(90 mm)		10
CTSPC(100 mm)		10
CTSPC(150 mm)		10
CTSPC(200 mm)		10
CTSPC(300 mm)		10

CSTSRN6



26 x 43 mm	
53.5 mm	
IEC	UL - CSA
1.5 - 35.0 mm ²	22 - 2 AWG

1.5 - 35.0 mm² 22 - 2 AWG

16 mm

IEC60947-7-1 CSA22.2-158

1100 V	600 V		
125 A	145 A		
3.0 Nm	27 lb-in		



Melamine / 1
8 KV / 3

Type / Cat. No.	Standard Pack
CSTSRN6	50
CSTSRN6BU	50
CSTSRN6R	50
CSTSRN6Y	50
CSTSRN6BK	50
CSTSREP	50
CA501-1M / CA501-1M-S	25 m
CA502 / CA702	50
CA509/K6WHT	100
M6	
MACKRN6	

Type / Cat. No.	I _{max}	Standard Pack
CA512/11-2	125 A	50
CA514/11-2	125 A	50
CA512/12-2	125 A	50
CA514/12-2	125 A	50
CSTSPC1		100
CSTSPC1-1		100
CTSPC(90 mm)		10
CTSPC(100 mm)		10
CTSPC(150 mm)		10
CTSPC(200 mm)		10
CTSPC(300 mm)		10

DISCONNECT & TEST TERMINAL BLOCKS

These blocks are used for measuring, control, regulatory circuits and for current transformer connection application. They provide a clear functional advantage for devices having utility instruments and associated transformers.

In CMDT4 terminal the disconnection of circuit is achieved by means of a central sliding link assembly with a clear orange indicator.

In the CMDT4S Terminal Block the orange indicator is replaced by a socket headed screw for achieving the circuit disconnection.

Cross connection is possible with the aid of external jumpers.

Barrel nuts provide test sockets for inserting test plugs and for carrying out current and voltage injection protocols.

CMDT4

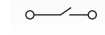
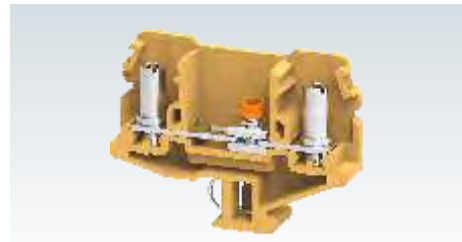

Width (Thickness) x Length	13 x 68 mm		
Height with DIN 32 x 15 mm Rail	51.7 mm		
Connection Possibility as per	IEC	UL - CSA	
With 1 Conductor per clamp	Stranded / Flexible with Ferrule / Lug	1.5 - 6.0 mm ²	22 - 8 AWG
With 2 same size Conductors per clamp	Solid with Ferrule / Lug	1.5 - 6.0 mm ²	22 - 8 AWG
Wire Stripping Length	12 mm		
Ratings As Per	IEC60947-7-1		
Voltage	1100 V		
Current	41 A		
Torque	1.2 Nm		
Approvals			
Insulation Material / Comparative Tracking Index	Melamine / 1		
Rated Impulse Voltage / Pollution Degree	8 KV / 3		

	Type / Cat. No.	Standard Pack
Terminal Block	CMDT4	50
	CMDT4BU	50
	CMDT4R	50
	CMDT4Y	50
	CMDT4BK	50
	EPCMDT4	50
End Plate	EPCMDT4	50
Mounting Rail (Refer Pg. 217 for details)	CA501-1M / CA501-1M-S	25 m
End Clamp (Refer Pg. 218 for details)	CA502 / CA702	50
Marking Tags (Refer Pg. 222 for details)	CA509/K2B4WHT	100
Screw Driver	SCS1.0/5.5 Blade size: 1.0 x 5.5 mm	10

	Type / Cat. No.	I _{max}	Standard Pack
Uninsulated Removable Jumper	2 pole CA512/2-2	41 A	100
	3 pole CA512/2-3	41 A	50
	4 pole CA512/2-4	41 A	50
Insulated Removable Jumper	2 pole CA514/2-2	41 A	100
	3 pole CA514/2-3	41 A	50
	4 pole CA514/2-4	41 A	50
Permanent Uninsulated Jumper	2 pole CA512/4-2	41 A	100
	3 pole CA512/4-3	41 A	50
	4 pole CA512/4-4	41 A	50
Permanent Insulated Jumper	2 pole CA514/4-2	41 A	100
	3 pole CA514/4-3	41 A	50
	4 pole CA514/4-4	41 A	50
Protective Cover	2 Terminal CDTPC1		100
	3 Terminal CDTPC2		100
Long Protective Cover	CDTPC3		10
	CDTPC4		10
	CDTPC5		10
	100 mm		
	200 mm		
300 mm			

CMDT4S



13 x 68 mm

51.7 mm

IEC	UL - CSA
1.5 - 6.0 mm ²	22 - 8 AWG

1.5 - 6.0 mm² 22 - 8 AWG

12 mm

IEC60947-7-1

1100 V

41 A

1.2 Nm



Melamine / 1

8 KV / 3

Type / Cat. No.	Standard Pack
CMDT4S	50
EPCMDT4	50
CA501-1M / CA501-1M-S	25 m
CA502 / CA702	50
CA509/K2B4WHT	100
SCS1.0/5.5 Blade size: 1.0 x 5.5 mm	10

Type / Cat. No.	I _{max}	Standard Pack
CA512/2-2	41 A	100
CA512/2-3	41 A	50
CA512/2-4	41 A	50
CA514/2-2	41 A	100
CA514/2-3	41 A	50
CA514/2-4	41 A	50
CA512/4-2	41 A	100
CA512/4-3	41 A	50
CA512/4-4	41 A	50
CA514/4-2	41 A	100
CA514/4-3	41 A	50
CA514/4-4	41 A	50
CDTPC1		100
CDTPC2		100
CDTPC3		10
CDTPC4		10
CDTPC5		10

CMDT4SH

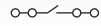

26 x 68 mm

51.7 mm

IEC	UL - CSA
1.5 - 6.0 mm ²	22 - 8 AWG

1.5 - 6.0 mm² 22 - 8 AWG

12 mm

IEC60947-7-1

500 V

32 A

1.2 Nm



Melamine / 1

8 KV / 3

Type / Cat. No.	Standard Pack
CMDT4SH	25
CMDT4SHBU	25
CMDT4SHR	25
CMDT4SHY	25
CMDT4SHBK	25
EPCMDT4	50
CA501-1M / CA501-1M-S	25 m
CA502 / CA702	50
CA509/K2B4WHT	100
SCS1.0/5.5 Blade size: 1.0 x 5.5 mm	10

Type / Cat. No.	I _{max}	Standard Pack
CA512/2-2	32 A	100
CA512/2-3	32 A	50
CA512/2-4	32 A	50
CA514/2-2	32 A	100
CA514/2-3	32 A	50
CA514/2-4	32 A	50
CA512/4-2	32 A	100
CA512/4-3	32 A	50
CA512/4-4	32 A	50
CA514/4-2	32 A	100
CA514/4-3	32 A	50
CA514/4-4	32 A	50

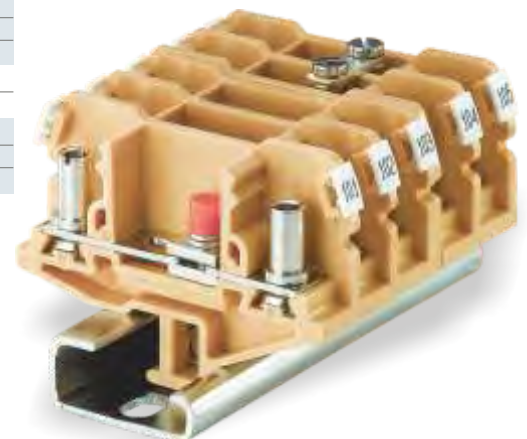

BUS BAR TYPE TERMINAL BLOCKS

These Terminal Blocks are preferred for applications using wires of a large cross section. The wire is crimped to a ring / fork type lug (ferrule) and is screwed on to the flat current bar on the Terminal Block. The range includes Terminal Blocks for wire sizes from 16 sq.mm to 120 sq.mm. Terminal Blocks with suffix LS have a threading in the current bar, eliminating the need of locking nuts.

Partition / Isolation Plate must be used with every Terminal Block. The Protective Cover is designed to be mounted on a specially designed slot in the Partition Plate.

Installation instruction:

It is recommended to provide a back support to the wire while tightening the clamping bolt to avoid deformation of the mounting rail or to prevent damage of the Terminal Block by torsional force.

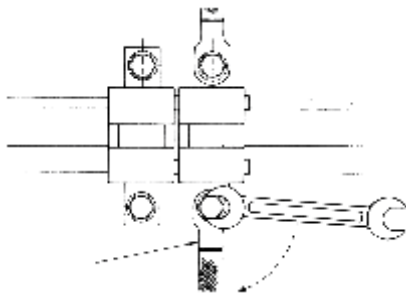

Width (Thickness) x Length		28 x 75 mm			
Height with DIN 32 x 15 mm Rail		55.2 mm			
Connection Possibility as per		IEC	UL - CSA		
With 1 Conductor per clamp	Stranded / Flexible with Ferrule / Lug	16.0 - 50.0 mm ²	8 - 2 AWG		
With 2 same size Conductors per clamp	Stranded / Flexible with Ferrule / Lug	16.0 - 50.0 mm ²	8 - 2 AWG		
Wire Stripping Length		12 mm			
Ratings As Per		IEC60947-7-1 CSA22.2-158			
Voltage		1000 V	600 V		
Current		150 A	145 A		
Torque		3.0 Nm	27 lb-in		
Approvals					
Insulation Material / Comparative Tracking Index		Melamine / 1			
Rated Impulse Voltage / Pollution Degree		8 KV / 3			
		Type / Cat. No.	Standard Pack		
Terminal Block	With Nut & Bolt configuration	CTS35L	10		
	With Threaded Current Bar	CTS35LS	10		
Partition / Isolation Plate (Polyamide 66)		EP4P	10		
Partition / Isolation Plate (Melamine)		CTSEP4	10		
Locating Support for Partition / Isolation Plate		CTSEP4LO	10		
Mounting Rail (Refer Pg. 217 for details)		CA501-1M / CA501-1M-S	25 m		
End Clamp (Refer Pg. 218 for details)		CA502 / CA702 / CA102	50		
Marking Tags (Refer Pg. 222 for details)		CA509/K2B4WHT	100		
Bolt Size		M6			
		Type / Cat. No.	I_{max}	Standard Pack	
Jumpers		2 pole	125 A	10	
		3 pole	125 A	10	
		Mounted on			
Long Protective Cover		90 mm	CTSPC3-2	EP4P	10
		210 mm	CTSPC2-1	CTSEP4	10
		100 mm	CTSPC2-2	CTSEP4	10
		190 mm			



CTS70L / CTS70LS



CTS70L

CTS70LS



40 x 92 mm

55.2 mm

IEC	UL - CSA
-----	----------

35.0 - 70.0 mm² 8 - 2/0 AWG

35.0 - 70.0 mm² 8 - 2/0 AWG

18 mm

IEC60947-7-1 CSA22.2-158

1000 V	600 V		
--------	-------	--	--

192 A	250 A		
-------	-------	--	--

10.0 Nm	87 lb-in		
---------	----------	--	--



Melamine / 1

8 KV / 3

Type / Cat. No.	Standard Pack
CTS70L	10
CTS70LS	10
EP4P	10
CTSEP4	10
CTSEP4LO	10
CA501-1M / CA501-1M-S	25 m
CA502 / CA702 / CA102	50
CA509/K2B4WHT	100
M8	

Type / Cat. No.	I _{max}	Standard Pack
CA797/2	185 A	10
CA797/3	185 A	10
Mounted on		
CTSPC3-2	EP4P	10
CTSPC2-1	CTSEP4	10
CTSPC2-2	CTSEP4	10

CTS95L / CTS95LS



CTS95L

CTS95LS



40 x 92 mm

55.2 mm

IEC	UL - CSA
-----	----------

35.0 - 95.0 mm² 8 - 4/0 AWG

35.0 - 95.0 mm² 8 - 4/0 AWG

20 mm

IEC60947-7-1 CSA22.2-158

1000 V	600 V		
--------	-------	--	--

232 A	300 A		
-------	-------	--	--

10.0 Nm	87 lb-in		
---------	----------	--	--



Melamine / 1

8 KV / 3

Type / Cat. No.	Standard Pack
CTS95L	10
CTS95LS	10
EP4P	10
CA501-1M / CA501-1M-S	25 m
CA502 / CA702 / CA102	50
CA509/K2B4WHT	100
M10	

Type / Cat. No.	I _{max}	Standard Pack
CA798/2	220 A	10
CA798/3	220 A	10
Mounted on		
CTSPC3-1	EP4P	10
CTSPC2-3	CTSEP4	10

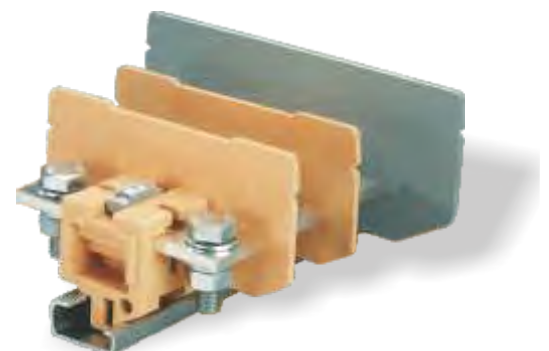

SPRING LOADED TERMINAL BLOCKS

These modified version of feed through Terminal Blocks come with safety springs. These Terminal Blocks are preferred for connections that involve safety requirements of the Electric Supply Industry (ESI) standards, British CEBG regulations and NTPC applications. In addition to the high torque screws, these blocks have a built-in spring loading feature. It is recommended to use hook type lugs for terminating wires in such connections. These Terminal Blocks have a specially designed current bar for the right location/ placement of wires with hook type lugs, thus preventing loosening of the wires even when the screw clamps are not tightened.

The housing of these Terminal Blocks is made of High Grade Melamine which has insulation properties in accordance with the CEBG regulations.







Width (Thickness) x Length	6.7 x 40 mm	
Height with DIN 32 x 15 mm Rail	52.0 mm	
Connection Possibility as per		
With 1 Conductor per clamp	Stranded / Flexible	0.2 - 4.0 mm ²
	Solid with Ferrule / Lug	0.2 - 6.0 mm ²
With 2 same size Conductors per clamp	Stranded / Flexible	0.2 - 4.0 mm ²
	with TWIN Ferrule / Lug	0.2 - 2.5 mm ²
Wire Stripping Length	12 mm	
Ratings As Per	IEC60947-7-1 CSA22.2-158	
Voltage	600 V	300 V
Current	32 A	35 A
Torque	0.5 Nm	7 lb-in
Approvals		

Insulation Material / Comparative Tracking Index	Melamine / 1	
Rated Impulse Voltage / Pollution Degree	8 KV / 3	







CTS4SC



IEC	UL - CSA	
0.2 - 4.0 mm ²	22 - 10 AWG	
0.2 - 6.0 mm ²	22 - 10 AWG	
0.2 - 4.0 mm ²	22 - 10 AWG	
0.2 - 2.5 mm ²	22 - 12 AWG	
0.2 - 2.5 mm ²	22 - 12 AWG	

Terminal Block	Type / Cat. No.	Standard Pack
Terminal Block	CTS4SC	200
End Plate 	CTSEP1	50
Partition Plate 	CTSP1L CTSP1B	50 50
Mounting Rail (Refer Pg. 217 for details) 	CA501-1M / CA501-1M-S	25 m
End Clamp (Refer Pg. 218 for details) 	CA502 / CA702	50
Marking Tags (Refer Pg. 222 for details) 	CA509/K2WHT	100
Screw Driver 	SCS0.6/3.5 Blade size: 0.6 x 3.5 mm	10

Type / Cat. No.	Imax	Standard Pack
CA501-1M / CA501-1M-S		25 m
CA502 / CA702		50
CA509/K2WHT		100
SCS0.6/3.5 Blade size: 0.6 x 3.5 mm		10

Jumpers	Type / Cat. No.	Imax	Standard Pack
Hook Type Lugs 	1.5 sq.mm	CA604/1	100
	2.5 sq.mm	CA604/2	100
	6 sq.mm		
	10 sq.mm		
Screw Type Jumpers 	2 pole	CA522/2	32 A 100
	3 pole	CA522/3	32 A 100
	4 pole	CA522/4	32 A 100
	10 pole	CA522/10	32 A 10
	Insulated Screw Type Jumpers 	2 pole	CA622/2
	3 pole	CA622/3	32 A 100
	4 pole	CA622/4	32 A 100
	10 pole	CA622/10	32 A 10
Jumper Bar 	2 pole	CA503/1	32 A 100
	3 pole	CA504/1	32 A 100
	4 pole	CA505/1	32 A 100
	10 pole	CA510/1	32 A 100
	Short Sleeve & Screw for configurable jumper bar 	CA507/S/Q/1	
Switchable Jumpers 	CA506/1	32 A	100
Long Sleeve & Screw for Switchable Jumpers 	CA707/L/Q/1		100

Type / Cat. No.	Imax	Standard Pack
CA604/1		100
CA604/2		100
CA522/2	32 A	100
CA522/3	32 A	100
CA522/4	32 A	100
CA522/10	32 A	10
CA622/2	32 A	100
CA622/3	32 A	100
CA622/4	32 A	100
CA622/10	32 A	10
CA503/1	32 A	100
CA504/1	32 A	100
CA505/1	32 A	100
CA510/1	32 A	100
CA507/S/Q/1		100
CA506/1	32 A	100
CA707/L/Q/1		100

CTS6SC



8 x 40 mm

52.0 mm

IEC	UL - CSA
1.5 - 6.0 mm ²	22 - 8 AWG
1.5 - 6.0 mm ²	22 - 8 AWG
1.5 - 4.0 mm ²	22 - 10 AWG
1.5 - 4.0 mm ²	22 - 10 AWG

12 mm

IEC60947-7-1 CSA22.2-158

600 V	300 V		
41 A	50 A		
0.8 Nm	14 lb-in		



Melamine / 1

8 KV / 3

Type / Cat. No.	Standard Pack
CTS6SC	200
CTSEP1	50
CTSP1L	50
CTSP1B	50
CA501-1M / CA501-1M-S	25 m
CA502 / CA702	50
CA509/K2WHT	100
SCS0.8/4 Blade size: 0.8 x 4 mm	10

Type / Cat. No.	I _{max}	Standard Pack
CA604/1		100
CA604/2		100
CA604/3		100
CA723/2	41 A	100
CA723/3	41 A	50
CA723/4	41 A	50
CA723/10	41 A	10
CA743/2	41 A	100
CA743/3	41 A	50
CA743/4	41 A	50
CA743/10	41 A	10
CA703/2	41 A	100
CA704/2	41 A	100
CA705/2	41 A	100
CA733/10	41 A	100
CA707/S/Q/1		100
CA706/2	41 A	100
CA707/L/Q/1		100

CTS10SC

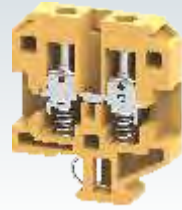

11 x 50 mm

59.5 mm

IEC	UL - CSA
1.5 - 10.0 mm ²	22 - 8 AWG
1.5 - 10.0 mm ²	22 - 8 AWG
1.5 - 6.0 mm ²	22 - 8 AWG
1.5 - 6.0 mm ²	22 - 10 AWG

12 mm

IEC60947-7-1 CSA22.2-158

800 V	300 V		
57 A	50 A		
1.2 Nm	14 lb-in		



Melamine / 1

8 KV / 3

Type / Cat. No.	Standard Pack
CTS10SC	100
CTSEP1SC	50
CTSP1SC	50
CA501-1M / CA501-1M-S	25 m
CA502 / CA702	50
CA509/K2WHT	100
SCS0.8/4 Blade size: 0.8 x 4 mm	10

Type / Cat. No.	I _{max}	Standard Pack
CA604/1		100
CA604/2		100
CA604/3		100
CA604/4		100
CA526/2	57 A	100
CA526/3	57 A	50
CA526/4	57 A	50
CA526/10	57 A	10
CA626/2	57 A	100
CA626/3	57 A	50
CA626/4	57 A	50
CA626/10	57 A	10
CA503/6	57 A	100
CA504/6	57 A	100
CA505/6	57 A	100
CA510/6	57 A	100
CA707/S/Q/3		100
CA506/6	57 A	100
CA707/L/Q/3		100

MULTIPOLE STRIP TERMINAL BLOCKS

The CMST series Terminal Blocks can be directly mounted on panel surfaces with the help of fixing screws. They are available from a 2 upto 12 pole configuration.

CMST2 series Terminal Blocks are an ideal choice for transformers. It has a special current bar design, enabling direct soldering of transformer wires.

The CMST terminal strip can also be fixed on the edge of transformer plates / panels with the help of FPCMST fixing plates.

Cross connection can be achieved with the aid of insulated jumpers.

CMST1



Connection Possibility as per		IEC	UL - CSA	
With 1 Conductor per clamp	Stranded / Flexible	0.2 - 2.5 mm ²	22 - 14 AWG	
	Solid with Ferrule / Lug	0.2 - 4.0 mm ²	22 - 10 AWG	
With 2 same size Conductors per clamp	Stranded / Flexible	0.2 - 2.5 mm ²	22 - 14 AWG	
	with TWIN Ferrule / Lug	0.2 - 1.5 mm ²	22 - 18 AWG	
Wire Stripping Length		9 mm		
Ratings As Per		IEC60947-7-1 CSA22.2-158		
Voltage		400 V	300 V	
Current		24 A	20 A	
Torque		0.4 Nm	4.5 lb-in	
Approvals				
Insulation Material / Comparative Tracking Index		Melamine / 1		
Rated Impulse Voltage / Pollution Degree		6 KV / 3		

Type / Cat. No.	Length (L) mm	Standard Pack
Terminal Block 12 pole	CMST1 110	20
2 pole	CMST12W 20	120
3 pole	CMST13W 29	80
4 pole	CMST14W 38	60
5 pole	CMST15W 47	45
6 pole	CMST16W 56	40
7 pole	CMST17W 65	30
8 pole	CMST18W 74	30
9 pole	CMST19W 83	25
10 pole	CMST110W 92	20

FPCMST Partition plate for terminal strip



Panel Fixing / Partition Plate		FPCMST		50
Two pole External Jumper		CA513	Imax.: 24 A	50
Marking Strip		CA509/7		10
Markers Fixing Screw with fibre washer size M3 x 18		CA502/F		20

Mounting of terminal strip with panel fixing plate FPCMST

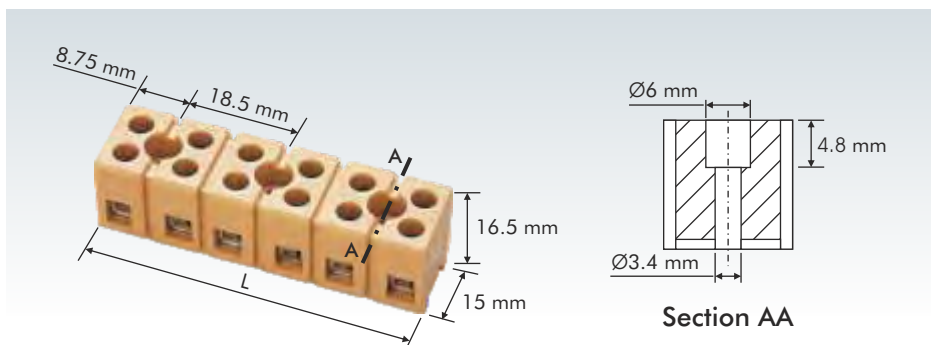
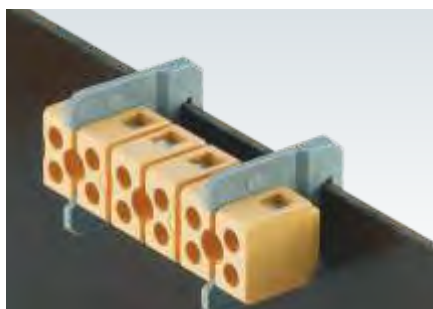

CMST2



Connection Possibility as per		IEC	UL - CSA	
With 1 Conductor per clamp	Stranded / Flexible	0.2 - 2.5 mm ²	22 - 14 AWG	
	Solid with Ferrule / Lug	0.2 - 4.0 mm ²	22 - 10 AWG	
With 2 same size Conductors per clamp	Stranded / Flexible	0.2 - 2.5 mm ²	22 - 14 AWG	
	with TWIN Ferrule / Lug	0.2 - 1.5 mm ²	22 - 18 AWG	
Wire Stripping Length		9 mm		
Ratings As Per		IEC60947-7-1 CSA22.2-158		
Voltage		400 V	300 V	
Current		24 A	20 A	
Torque		0.4 Nm	4.5 lb-in	
Approvals				
Insulation Material / Comparative Tracking Index		Melamine / 1		
Rated Impulse Voltage / Pollution Degree		6 KV / 3		
		Type / Cat. No.	Length (L) mm	Standard Pack
Terminal Block	12 pole	CMST2	110	20
	2 pole	CMST22W	20	120
	3 pole	CMST23W	29	80
	4 pole	CMST24W	38	60
	5 pole	CMST25W	47	45
	6 pole	CMST26W	56	40
	7 pole	CMST27W	65	30
	8 pole	CMST28W	74	30
	9 pole	CMST29W	83	25
	10 pole	CMST210W	92	20
Panel Fixing / Partition Plate		FPCMST		50
Two pole External Jumper		CA513	I _{max} : 24 A	50
Marking Strip		CA509/7		10
Markers Fixing Screw with fibre washer size M3 x 18		CA502/F		20

CERAMIC TERMINAL BLOCKS

These Terminal Blocks are used in extremely high temperature applications such as hot melt glue guns, furnaces, heaters, process equipment and machinery. These Ceramic Terminal Blocks have an operating temperature range of -40° to 650°C.

CB4



Height x Width (Thickness)	25 x 19 mm		
Connection Possibility as per	IEC	UL - CSA	
With 1 Conductor per clamp	Stranded / Flexible	0.5 - 2.5 mm ²	24 - 12 AWG
	Solid	0.5 - 4.0 mm ²	24 - 10 AWG
	with Ferrule / Lug	0.5 - 2.5 mm ²	24 - 12 AWG
With 2 same size Conductors per clamp	Stranded / Flexible	0.5 - 1.5 mm ²	24 - 12 AWG
	with TWIN Ferrule / Lug	0.5 - 1.5 mm ²	24 - 12 AWG
Wire Stripping Length	8 mm		
Ratings As Per	IEC60947-7-1	UL-1059	CSA22.2-158
Voltage	800 V	300 V	300 V
Current	24 A	20 A	30 A
Torque	0.4 Nm	6 lb-in	7 lb-in
Approvals			
Insulation Material / Comparative Tracking Index	Ceramic / 1		
Rated Impulse Voltage / Pollution Degree	4 KV / 3		
No. of Poles	Type	Type / Cat. No.	Standard Pack
1	Free Floating	CB4/1	50
2	Free Floating	CB4/2	100
2	With Mounting Hole	CB4/2H	50
3	Free Floating	CB4/3	50
3	With Mounting Hole	CB4/3H	50
Screw Driver		SCS0.5/3 Blade size: 0.5 x 3 mm	10

Design A

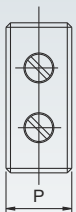

Design B

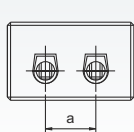
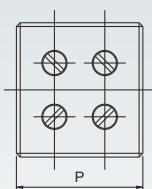

Design C

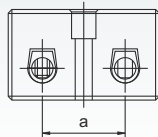
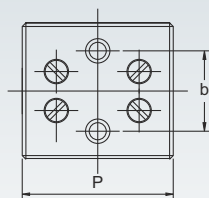

Design D

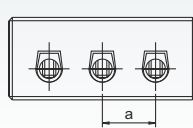
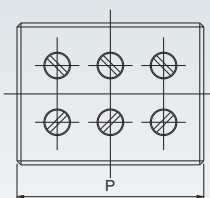

Design E

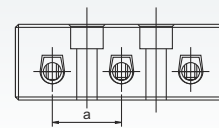
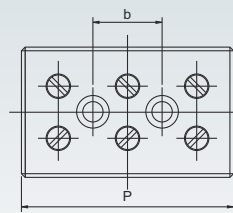

Design F

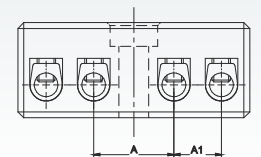
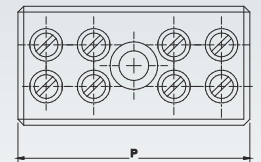



IEC	UL - CSA
0.5 - 4.0 mm ²	22 - 10 AWG
0.5 - 6.0 mm ²	
0.5 - 4.0 mm ²	22 - 10 AWG
0.5 - 2.5 mm ²	22 - 12 AWG
0.5 - 2.5 mm ²	22 - 12 AWG

IEC	UL - CSA
1.5 - 10.0 mm ²	18 - 6 AWG
1.5 - 10.0 mm ²	
1.5 - 10.0 mm ²	18 - 6 AWG
1.5 - 6.0 mm ²	18 - 8 AWG
1.5 - 6.0 mm ²	18 - 8 AWG

8 mm

IEC60947-7-1	UL-1059	CSA22.2-158
800 V	300 V	300 V
32 A	30 A	40 A
0.5 Nm	6 lb-in	7 lb-in

8 mm

IEC60947-7-1	UL-1059	CSA22.2-158
800 V	300 V	300 V
57 A	65 A	76 A
1.2 Nm	12 lb-in	14 lb-in



Ceramic / 1
4 KV / 3

Ceramic / 1
4 KV / 3

Type / Cat. No.	Standard Pack
CB6/1	50
CB6/2H	50
CB6/3H	50
CB6/4H	50
SCS0.8/4 Blade size: 0.8 x 4 mm	10

Type / Cat. No.	Standard Pack
CB16/2H	50
CB16/3H	50
SCS0.8/4 Blade size: 0.8 x 4 mm	10







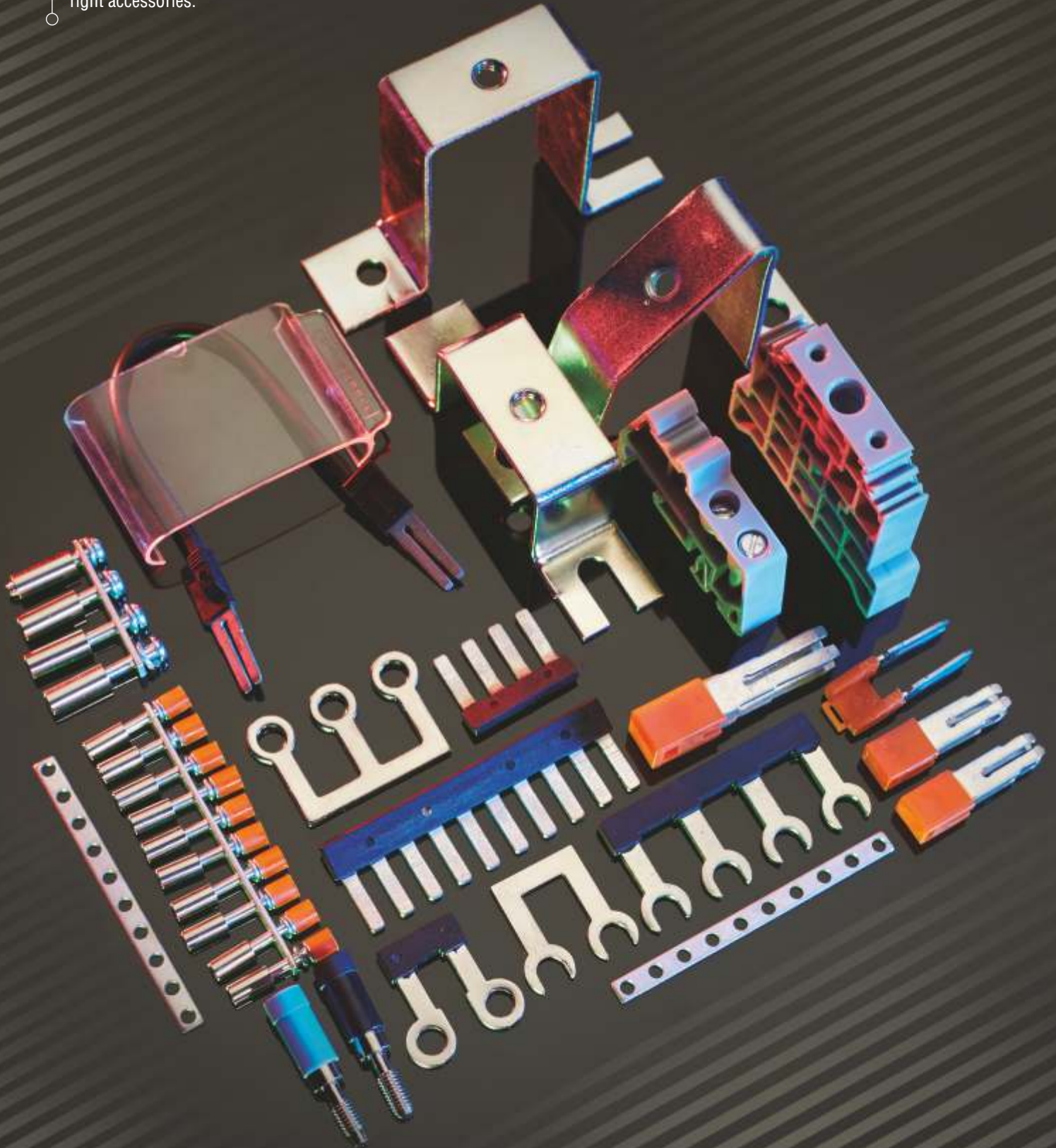









Type Cat. No.	Design Type	No. of Poles	Stripping Length	P	a	b	Fixing Screw
CB4/1	A	1	6	11	-	-	-
CB4/2	B	2	6	18	7.2	-	-
CB4/2H	C	2	6	23	13.6	14.5	M3 x 16
CB4/3	D	3	6	25	7.2	-	-
CB4/3H	E	3	6	36	13	13	M3 x 16
CB6/1	A	1	6	12	-	-	-
CB6/2H	C	2	6	26	15	12.6	M3 x 16
CB6/3H	E	3	6	41	15	15	M3 x 16
CB6/4H	F	4	8	40	13.5	-	M8 x 16
CB16/2H	C	2	8	31	17	16.5	M3 x 20
CB16/3H	E	3	8	48	17	17	M3 x 20

ACCESSORIES

Create effective assemblies by using the right accessories.



ACCESSORIES

	Mounting Rail	217
	End Clamp	218
	Group Marker Holder	219
	Mounting Brackets / Spacer	220
	Mounting Handle / Mounting Base	221
	Marking Tags	222
	Warning Labels / Test Plugs	223
	Marker Plotter System	225 - 226
	Screw Clamp Terminal Block Jumpers	227 - 230
	Melamine Terminal Block Jumpers	231 - 232
	Stud Type Terminal Block Jumpers	231 - 232
	CX, CSC, CY, AS Series Terminal Jumpers	233
	End Plates	234 - 235
	Partition & Separator Plates	235
	Protective Covers	236
	Professional Tools	237 - 239
	Sockets & Switches	241 - 242

MOUNTING RAILS

Most of Connectwell's Terminal Blocks and Interface Modules are designed to be mounted on DIN Rails (Channels) that can be fixed easily on panel boards and other equipment.

Connectwell offers three types of steel mounting rails: Din 32, Din 35 and Din 15 that comply with European standards **EN 50 0035**, **EN 50 022** and **EN 50 045** respectively. The rails are zinc plated and chromate passivated. According to the **DIN VDE 0611** part 3, steel mounting rails are permissible as grounding bus bars (**PE** function) but do not have the **PEN** function.

All mounting rails are available in standard 1m and 2 m lengths. Cut to length mounting rails with holes / slots as per customer requirement are also available on request.

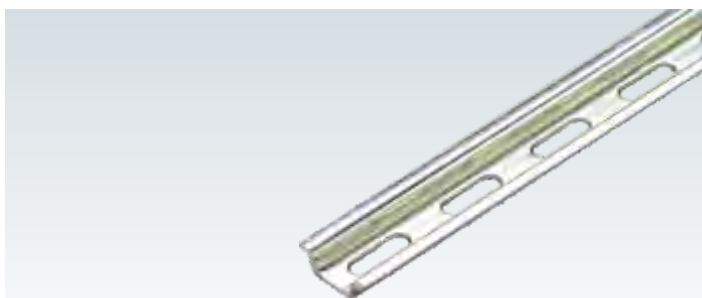
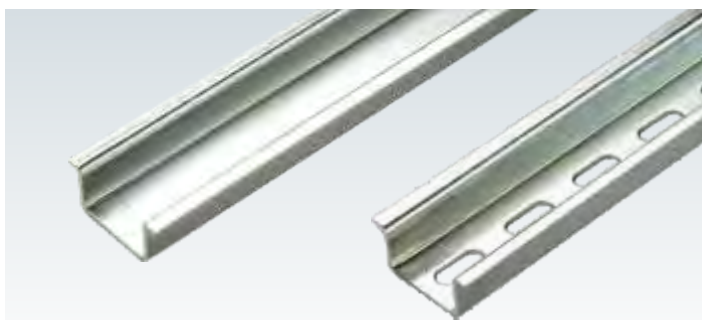
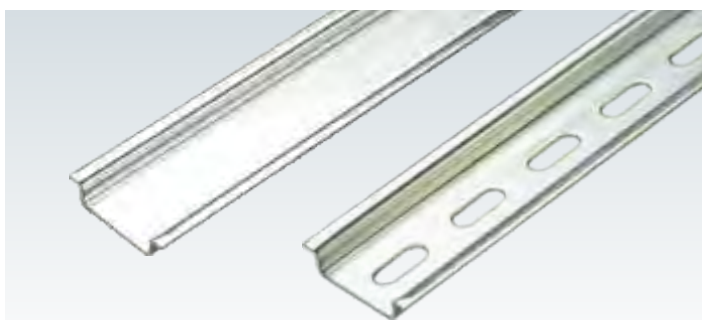
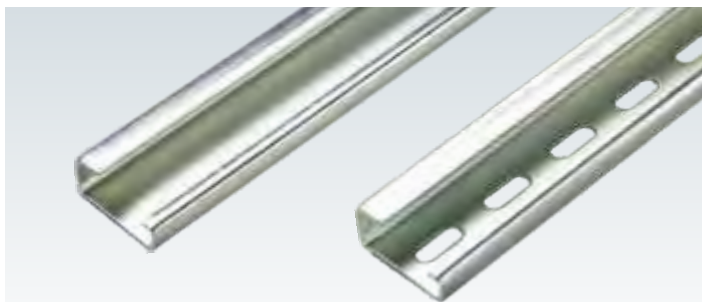

Din 32 Rail [Din 1] (32 x 15 x 1.5 mm)

Part No.	Length/Type	Standard Pack
CA501-1M	1 m, unslotted	25 m
CA501-1M-S	1 m, slotted	25 m
CA501-2M	2 m, unslotted	50 m
CA501-2M-S	2 m, slotted	50 m

Din 35 Rail [Din 3] (35 x 7.5 x 1.0 mm)

Part No.	Length/Type	Standard Pack
CA701-1M	1 m, unslotted	50 m
CA701-1M-S	1 m, slotted	50 m
CA701-2M	2 m, unslotted	50 m
CA701-2M-S	2 m, slotted	50 m

Din 35-15 Rail [Din 1] (35 x 15 x 1.5 mm)



Part No.	Length/Type	Standard Pack
CA701-15-1M	1 m, unslotted	25 m
CA701-15-1M-S	1 m, slotted	25 m
CA701-15-2M	2 m, unslotted	50 m
CA701-15-2M-S	2 m, slotted	50 m



Din 15 Rail [Din 2] (15 x 5 x 1.0 mm)



Part No.	Length/Type	Standard Pack
CA601-1M	1 m, slotted	100 m

END CLAMPS

End Clamps help to secure the entire Terminal Block assembly on the DIN Rail. End Clamps should be fixed on both sides of the Terminal Block assemblies. These End Clamps are designed to fix on DIN 32, DIN 35 and DIN 15 rails. The Polyamide series End Clamps have suitable recesses to accommodate a group marker holder and marking tags for group identification. The steel parts are Zinc plated and Chromate passivated. The CA102 and CA202 are large End Clamps for heavy duty applications. CA103 is a screwless End Clamp which can be snapped on to the Din Rail.

CA702			CA102			CA802		
								
Width (Thickness) x Length	9 x 45 mm		Width (Thickness) x Length	9 x 46 mm		Width (Thickness) x Length	8 x 45 mm	
Height with DIN 35 x 7.5 mm Rail	35.75 mm		Height with DIN 35 x 7.5 mm Rail	51.40 mm		Height with DIN 35 x 7.5 mm Rail	31.30 mm	
Height with DIN 35 x 15 mm Rail	43.30 mm		Height with DIN 35 x 15 mm Rail	58.90 mm		Height with DIN 35 x 15 mm Rail	38.80 mm	
Height with DIN 32 mm Rail	36.85 mm		Height with DIN 32 mm Rail	52.50 mm				
Material	Polyamide		Material	Polyamide		Material	Polyamide	
Part No.	Suitable For	Std. Pack	Part No.	Suitable For	Std. Pack	Part No.	Suitable For	Std. Pack
CA702	DIN 32 / DIN 35 / DIN 35-15 Rail	50	CA102	DIN 32 / DIN 35 / DIN 35-15 Rail	50	CA802	DIN 35 / DIN 35-15 Rail	50

CA202			CA103			CA104		
								
Width (Thickness) x Length	9.5 x 50 mm		Width (Thickness) x Length	6 x 41 mm		Width (Thickness) x Length	10 x 41 mm	
Height with DIN 35 x 7.5 mm Rail	48.50 mm		Height with DIN 35 x 7.5 mm Rail	36.10 mm		Height with DIN 35 x 7.5 mm Rail	36.10 mm	
Height with DIN 35 x 15 mm Rail	55.80 mm		Height with DIN 35 x 15 mm Rail	43.25 mm		Height with DIN 35 x 15 mm Rail	43.25 mm	
Material	Polyamide		Material	Polyamide		Material	Polyamide	
Part No.	Suitable For	Std. Pack	Part No.	Suitable For	Std. Pack	Part No.	Suitable For	Std. Pack
CA202	DIN 35 / DIN 35-15 Rail	25	CA103	DIN 35 / DIN 35-15 Rail	50	CA104	DIN 35 / DIN 35-15 Rail	50

CA602			CA302 / CA402			CA502		
								
Width (Thickness) x Length	8 x 28 mm		Width (Thickness) x Length	16 x 27 mm		Width (Thickness) x Length	11.5 x 22.5 mm	
Height with DIN 15 mm Rail	21.60 mm		Height with DIN 35 x 7.5 mm Rail	29.00 mm		Height with DIN 32 mm Rail	29.20 mm	
Height with DIN 35 x 15 mm Rail			Height with DIN 35 x 15 mm Rail	37.50 mm				
Material	Polyamide		Material	Steel		Material	Steel	
Part No.	Suitable For	Std. Pack	Part No.	Suitable For	Std. Pack	Part No.	Suitable For	Std. Pack
CA602	DIN 15 Rail	50	CA302	DIN 35 Rail	50	CA502	DIN 32 Rail	50
			CA402	DIN 35-15 Rail	50			

GROUP MARKER HOLDER

Two variants of Group Marker Holders are available for identification of Terminal Block assemblies:

GMH1, GMH2, GMH3, GMH4, GMH5 and **GMH8** are to be mounted in the grooves of End Clamps.

CA509/G1 marking tag can be used with these marker holders or can be directly mounted on the end clamp.

GMH6 & GMH7 can be mounted directly on Din Rails. A sticker / paper needs to be inserted in the slot which is covered by a transparent plastic sheet.



Height x Length x Thickness (mm)	46.5 x 44.5 x 9.5	Height x Length x Thickness (mm)	46.5 x 44.5 x 19.5	Height x Length x Thickness (mm) GMH8 / GMH8N	44.65 x 31.10 x 10 / 6 mm
Material	Polyamide 66	Material	Polyamide 66	Height x Length x Thickness (mm) GMH9	45.65 x 31.10 x 12 mm
				Material	Polyamide 66

Part No.	Suitable For	Std. Pack	Part No.	Suitable For	Std. Pack	Part No.	Suitable For	Std. Pack
GMH6	DIN 32 / DIN 35 / DIN 35-15 Rail	50	GMH7	DIN 32 / DIN 35 / DIN 35-15 Rail	50	GMH8 / GMH8N	CA103 / CA104	100
						GMH9	CA103 / CA104	100

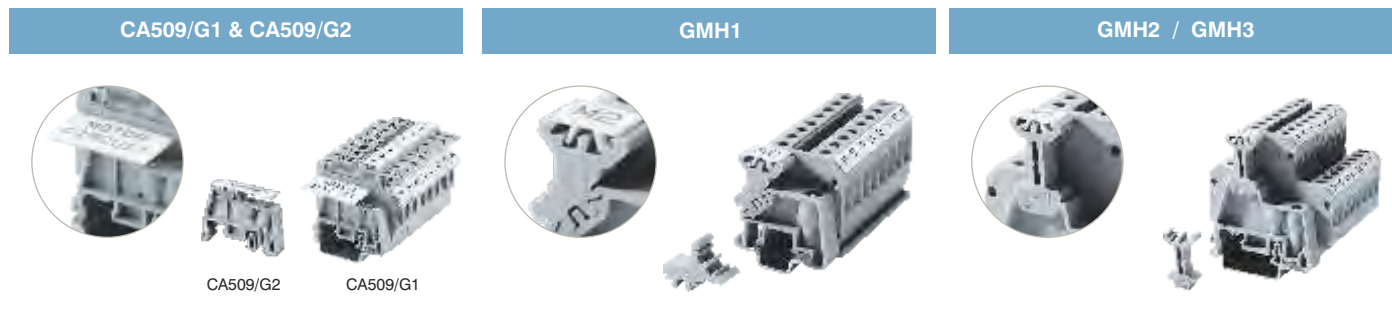

Material	Polyamide 66	Height x Length x Thickness	15.8 x 14.6 x 8 mm	Height x Length x Thickness GMH2	23.2 x 14 x 8 mm
Mountable on all End Clamps		Material	Polyamide 66	Height x Length x Thickness GMH3	23 x 14 x 8 mm
				Material	Polyamide 66

Part No.	Dimension (H x L x T)	Std. Pack	Tags	Part No.	Suitable For	Std. Pack	Part No.	Suitable For	Std. Pack
CA509/G1	4.3 x 34 x 17.8 mm	1 Pkt	100	GMH1	CA602	100	GMH2	CA702	100
CA509/G2	4.3 x 34 x 8 mm	1 Pkt	100				GMH3	CA802	100

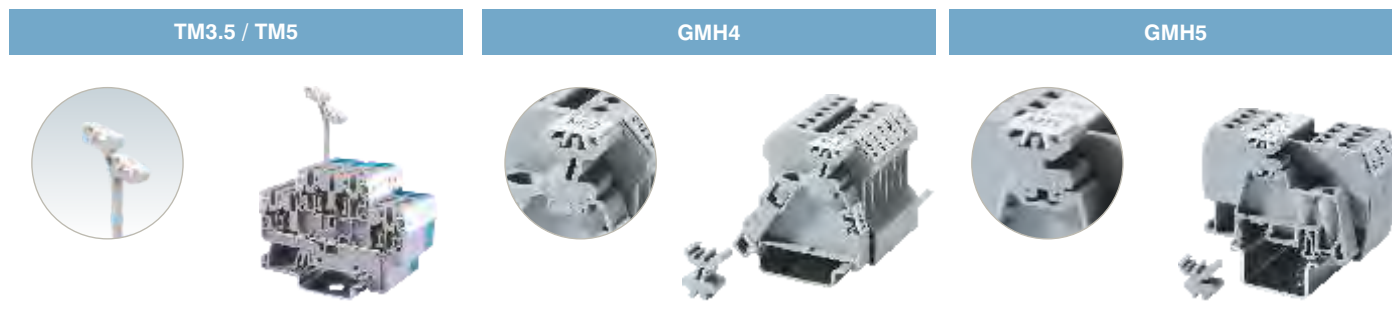

TM3.5 (Height x Length x Thickness)	34 x 17.8 x 3.5 mm	Height x Length x Thickness	16.2 x 14 x 8 mm	Height x Length x Thickness	13.7 x 14 x 8 mm
TM5 (Height x Length x Thickness)	38 x 17 x 5 mm	Material	Polyamide 66	Material	Polyamide 66
Material	Polyamide 66				

Part No.	Suitable For	Std. Pack	Part No.	Suitable For	Std. Pack	Part No.	Suitable For	Std. Pack
TM3.5	CPDL Series Terminals	50	GMH4	CA802	100	GMH5	CA702	100
TM5	CXDL Series Terminals	50						

MOUNTING BRACKETS

These are used for better access and increased clearance from the surface of the panel. These brackets are made of mild steel with zinc plating & chromate passivation.

CA603 - Can be used to install mounting rails at an angle of 45° to the panel surface.

CA703 / CA803 / CA903 - Are used for fixing mounting rails at different heights.

Part No. CA603	Std. Pack 25	Part No. CA703	Std. Pack 25	Part No. CA803	Std. Pack 25	Part No. CA903	Std. Pack 25

SPACER

CASP can be used to increase the creepage and clearance distance between the Terminal Blocks and to segregate the different groups of Terminal Blocks.

CDL4USP can be stacked with the **CDL4U(O)** Terminal Block to create a housing for discrete components or small electronic circuits.

Similarly CDL4UNSP fits the CDL4UN Terminal Block. The stacked housing can be fitted with an end plate to create a 'touch-proof' housing.



Width (Thickness) x Length	8 x 45 mm	
Height with DIN 35 x 7.5 mm Rail	30.50 mm	
Height with DIN 35 x 15 mm Rail	38.10 mm	
Height with DIN 32 mm Rail	35.45 mm	
Material	Polyamide 66	
Part No.	Suitable For	Std. Pack
CASP	DIN 32 / DIN 35 / DIN 35-15 Rail	50

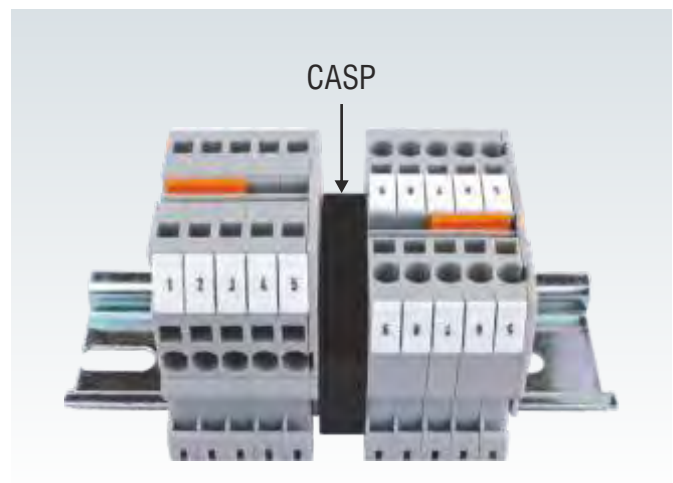

Material	Polyamide 66		
Part No.	Suitable For	Dimension (T x L x H)	Std. Pack
CDL4USP	CDL4U	54 x 55.5 x 6 mm	50
CDL4UNSP	CDL4UN	57 x 58 x 6 mm	50

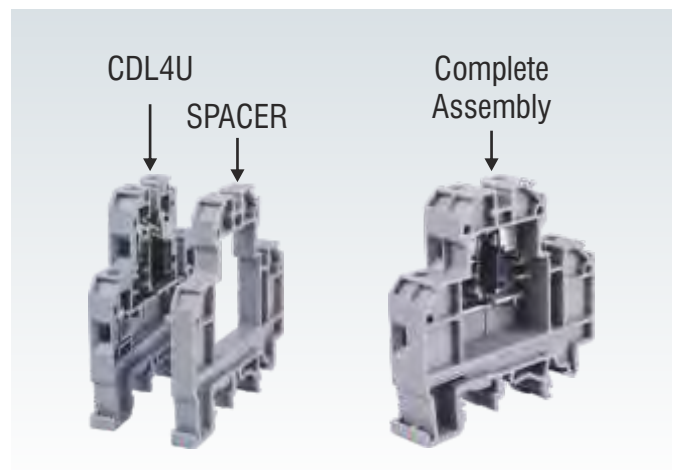

MOUNTING HANDLE

The Mounting Handle is used for easy and quick mounting of 10 Terminal Blocks on a Din Rail. The Terminal Blocks can be lifted from the packaging box with the help of this tool.



Part No.	Suitable for	Standard Pack
MH2.5	CTS2.5UN	1
MH4	CTS2.5UE / CTS4UN	1

MOUNTING BASE

CMTB35 is used to assemble components on a Din Rail. The mounting base has 4 holes of $\varnothing 4.3$ mm and 2 holes of $\varnothing 5.5$ mm. CA902 can be used to fasten Din 15 Rail on to the Din 32 Rail.

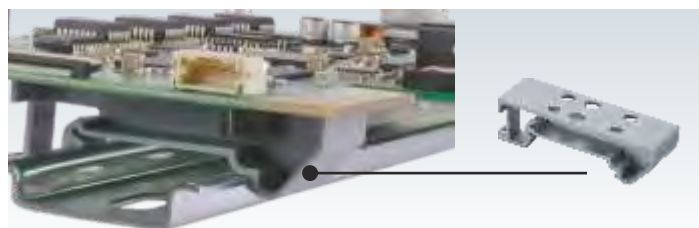
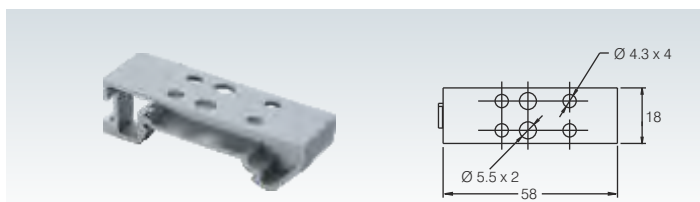

Part No.	Suitable for	Standard Pack
CMTB35	Din 35 rail mounting	50

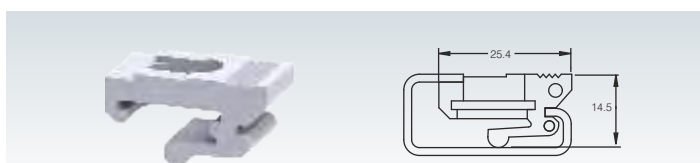

Part No.	Suitable for	Standard Pack
CA902	Din 32 rail mounting	50

SPRING CLAMP ACTUATOR TOOL

The spring clamp actuator tool can actuate two adjacent springs thereby facilitating rapid wiring.



Part No.	Suitable for	Standard Pack
SCA2.5	CX2.5, CXDL2.5, CM2.5S, CXM2.5, CSCP2.5 Series Terminals	1

MARKING TAGS

'K' Series Marking Tags

The quick to fix 'K' series Marking Tags facilitate identification of Electrical circuits in a Terminal Block assembly. This in turn makes the maintenance of individual components quicker and hassle free. The tags come with a large surface area providing better visibility. All 'K' series tags are available as strips in which an individual marker can be easily separated. CA509/K6F and CA509/K9F marking tags are continuous strips of 60 mm and 90 mm length respectively. The Marking Tags are available in both printed and blank versions. The printing can be horizontal or vertical in 2 or 3 digits, alphabets or symbols or a combination of these depending on user's requirement.

For ordering pre-printed marking tags, the following pattern should be followed:

For a strip of marking tags for CTS2.5UN Terminal Blocks marked horizontally from 1 to 10: CA509/K5/H/1-10 

For a strip of marking tags for CTS4UN Terminal Blocks marked vertically with alphabet A: CA509/K6/V/A 

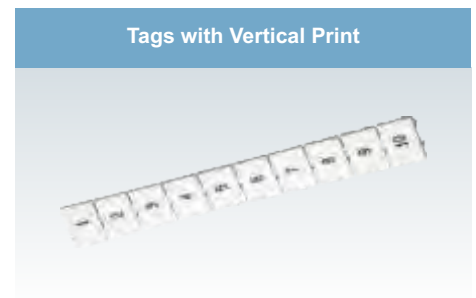
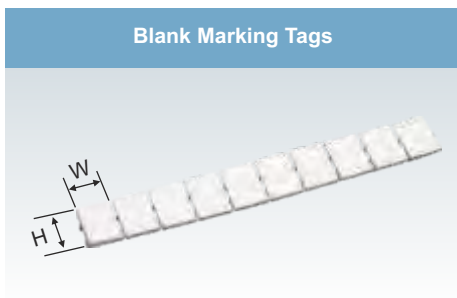

Part No.	Std. Pack		Dimensions	
	Packet	Strips	H	W
CA509/K2WHT	1	10	4.9	5.8
CA509/K3WHT	1	20	5.0	10.0
CA509/K4WHT	1	10	5.0	4.8
CA509/K5WHT	1	10	9.5	4.5
CA509/K6WHT	1	10	9.5	5.6
CA509/K6FWHT	1	10	9.5	60
CA509/K7.5WHT	1	10	5.3	7.5
CA509/K8WHT	1	10	10.5	7.5
CA509/K9WHT	1	10	10.3	8.7
CA509/K9FWHT	1	10	10.3	90.0
CA509/K10WHT	1	20	10.4	9.5
CA509/K12WHT	1	20	10.4	11.4
CA509/K16WHT	1	20	10.5	15.4
CA509/K2GWHT	1	10	5.0	5.0
CA509/K2B4WHT	1	10	5.8	9.1
CA509/K3.5WHT	1	8	9.2	3.5
MS3.5WHT	1	8	8	3.5
MS5WHT	1	10	5.0	8.0

Part No.	Std. Pack		Dimensions	
	Packet	Strips	H	W
CA509/K2/H	1	10	4.9	5.8
CA509/K3/H	1	20	5.0	10.0
CA509/K4/H	1	10	5.0	4.8
CA509/K5/H	1	10	9.5	4.5
CA509/K6/H	1	10	9.5	5.6
CA509/K6F/H	1	10	9.5	60
CA509/K7.5/H	1	10	5.3	7.5
CA509/K8/H	1	10	10.5	7.5
CA509/K9/H	1	10	10.3	8.7
CA509/K9F/H	1	10	10.3	90.0
CA509/K10/H	1	20	10.4	9.5
CA509/K12/H	1	20	10.4	11.4
CA509/K16/H	1	20	10.5	15.4
CA509/K2G/H	1	10	5.0	5.0
CA509/K2B4/H	1	10	5.8	9.1
CA509/K3.5WHT	1	8	9.2	3.5
MS3.5WHT	1	8	8	3.5
MS5WHT	1	10	5.0	8.0

Part No.	Std. Pack		Dimensions	
	Packet	Strips	H	W
CA509/K2/V	1	10	4.9	5.8
CA509/K3/V	1	20	5.0	10.0
CA509/K4/V	1	10	5.0	4.8
CA509/K5/V	1	10	9.5	4.5
CA509/K6/V	1	10	9.5	5.6
CA509/K6F/V	1	10	9.5	60
CA509/K7.5/V	1	10	5.3	7.5
CA509/K8/V	1	10	10.5	7.5
CA509/K9/V	1	10	10.3	8.7
CA509/K9F/V	1	10	10.3	90.0
CA509/K10/V	1	20	10.4	9.5
CA509/K12/V	1	20	10.4	11.4
CA509/K16/V	1	20	10.5	15.4
CA509/K2G/V	1	10	5.0	5.0
CA509/K2B4/V	1	10	5.8	9.1
CA509/K3.5WHT	1	8	9.2	3.5
MS3.5WHT	1	8	8	3.5
MS5WHT	1	10	5.0	8.0

WARNING LABELS

Warning label that can be mounted on top of the Terminal Block for giving visual identification, it also makes an entire DIN Rail Terminal Block assembly completely shock proof.

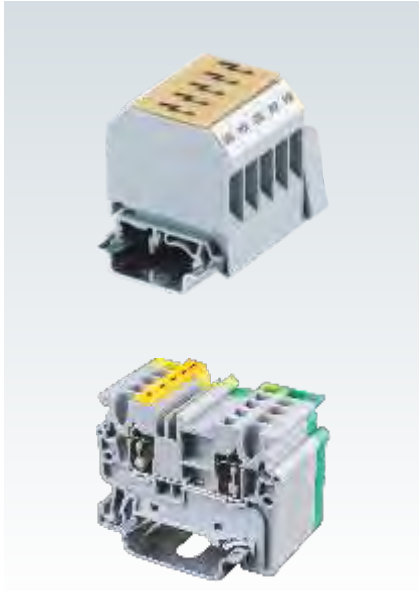
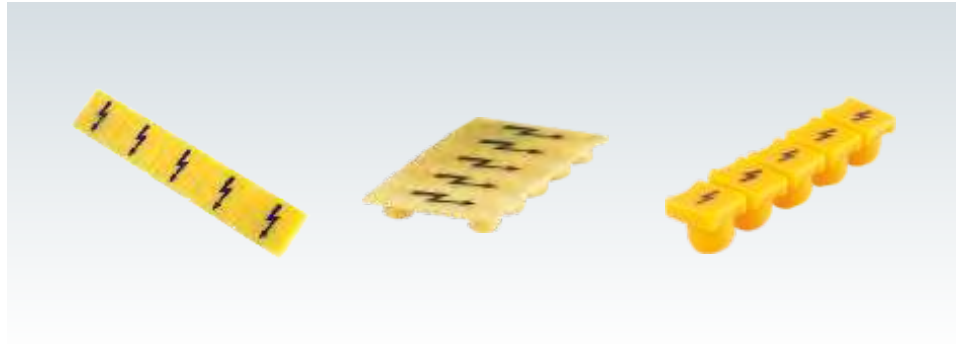

Terminal Block	Part No.	Standard Pack		
		Packet	Strips	Labels
CX2.5, CXG2.5 Series CXDL, CXDLG2.5 Series CXK2.5 Series CXM2.5, CXMG2.5	WLX2.5 WLX2.5/V (Vertical Imprint)	1	20	100
CX4, CXG4 Series CXF, CXVF Series CXK4 Series CYF, CYK, CYDLK Series	WLX4	1	20	100
CX6, CXG6 Series CXDB Series	WLX6	1	20	100
CX10, CXG10 Series	WLX10	1	20	100
CSC16T, CSCG16T	SWL16	1	20	100
CTS4UN, CTS2.5UE CDB4, CMDB4 Series	SWL4	1	20	100
CTS6U CDB6, CMDB6 Series	SWL6	1	20	100

TEST PLUGS

The Test Plugs make contact with the Jumper shaft of Terminal Block. Test adapters can be assembled with spacer to create space between two plugs & making alternate arrangement.



Terminal Block	Part No.	Standard Pack
CX2.5, CXG2.5 Series CXDL, CXDLG2.5 Series CXK2.5 Series CXM2.5, CXMG2.5	TX2.5	20

Coil Actuation
LED Indicator

Easy Legibility
Top Marker

Easy Cross Connection
with the use of Plug in
Links at Input or Output

Choice of Pluggable
Solid State or
Electromechanical Relays

Choice of Screw or
Spring Clamp
Connection

Integrated Input
Protection Circuit

SLIM RELAYS



In today's high-tech world it has become inevitable that control panels will progressively reduce in size, forcing us to do a lot more in a lot less space.

Connectwell brings you the right solution to such problems in the form of Slim Relays for switching and control applications. Conventional Relay Modules occupy about 20 mm per channel but with Slim Relays the same can be achieved in just **6 mm**.

This is what we at Connectwell call Sensible Switching ...

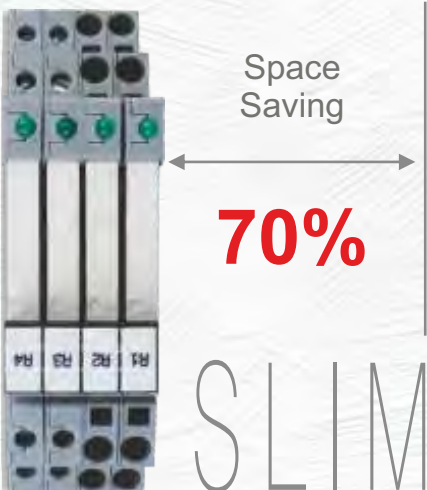

CSRxx (Electromechanical) and CSERxx (Solid State) Relay:

	Electro Mechanical Relay	SSR DC In - DC Out	SSR DC In - AC Out
Contact Type	1 CO	1 NO	1 NO
Input Voltages	5 VDC, 24VDC, 12 VUC, 24 VUC, 48-60 VUC, 120 VUC, 230 VUC, 230 VAC	24VDC, 24 VUC, 48-60 VUC, 120 VUC, 230 VAC	24VDC, 24 VUC, 48-60 VUC, 120 VUC, 230 VAC
Contact Rating	250 VAC / 30 VDC	48 VDC	240 VAC

MARKER PLOTTER SYSTEM

CMPS600 BASIC & CMPS600

The CMPS600 BASIC and CMPS600 units are auxiliary plotters and has to be connected to a computer via a USB connection. It is a high speed plotting device and enables plotting of different markers in one setting. The marker fixture and the plotter pen have to be inserted before commencing the plotting operation. The base unit is primarily controlled through a computer with the help of CMPS software.

Dimensions for CMPS600 BASIC are 470 x 480 x 155 mm.

Dimensions for CMPS600 are 690 x 480 x 155 mm.

Technical Information:

Type of plotter	: Flatbed plotter
Plotting speed with pen	: up to 40 mm/s
Plotter pen	: Special plotter pens with HP fixing
Addressable resolution	: 0.01 mm
Repeat accuracy	: 0.05 mm
PC Interface	: USB Port
Power supply input voltage	: 100-240V AC / 50-60Hz
Power supply input current	: 0.7 A max.
Power supply output voltage	: 24 V DC
Power supply output current	: 1.25 A max.

VE600

The engraving unit was specifically designed to be used with the CMPS600 BASIC and CMPS600 plotter systems. Changing back and forth between the pen-plotter and the engraver is easy. The engraver is meant to engrave signs on plastic, aluminium and other soft metals. Legend plates, push button inlays and other signage etc. can easily be produced with the VE600 engraving system.

The engraver also uses the standard CMPS software.

CMPS600 BASIC

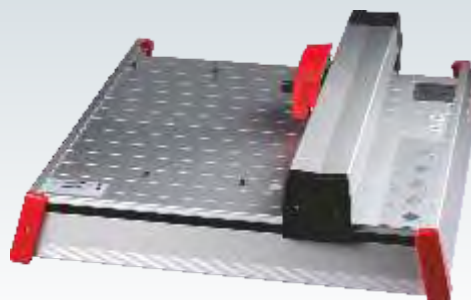

Description	Part No.
CMPS600 BASIC, A4 Size Plotter Unit (includes cable, power adapter & software)	PL-34130098

CMPS600

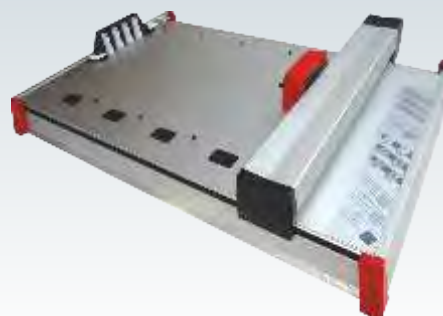

Description	Part No.
CMPS600, A3 Size Plotter Unit (includes cable, power adapter & software)	PL-34130099

ENGRAVING SYSTEM (VE600)

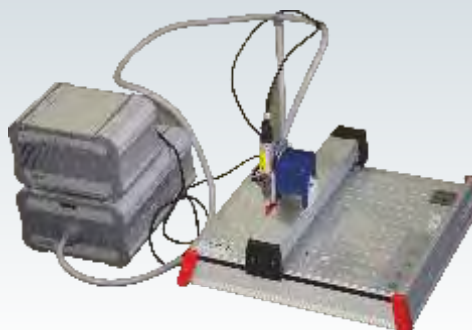

Description	Part No.
VE600 ENGRAVER UNIT (CMPS600 BASIC or CMPS600 REQUIRED)	PL-34000083

MARKER PLOTTER & ENGRAVER ACCESSORIES

DISPOSABLE PENS

These tubular nib pens are suitable for the CMPS600BASIC and CMPS600 plotters. The disposable pens use a special ink to deliver outstanding durability and print quality with the convenience of a use and throw system. This eliminates the need for messy ink refilling and pen cleaning operation. The ink is fast drying, smudge proof, fade resistant and resistant to chemicals when used on the 'K' series Connectwell marking tags. They are available in 6 sizes differentiated by their body colour.



Tip Width	Part No.
0.18 mm	PL-35003118
0.25 mm	PL-35003125
0.35 mm	PL-35003135
0.50 mm	PL-35003150
0.70 mm	PL-35003170
1.00 mm	PL-35003200

FIXTURES

Fixtures are required for alignment of markers with respect to the plotter pen. Different marker fixtures can be mounted on the plotter bed of the CMPS600 BASIC and CMPS600 plotters at the same time thereby reducing its set up time.

The CMPS600BASIC plotter bed can accept:

- 2 of the K5 fixtures or
- 2 of the K2 fixtures or
- 1 each of the above fixtures or
- 1 of the K5 triple fixture.

The CMPS600 plotter bed can accept:

- 4 of the K5 fixtures or
- 4 of the K2 fixtures or
- a combination of the above two fixtures.

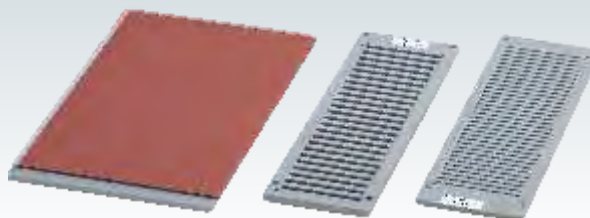

Description	For Marking Tag	Holding Capacity	Part No.
K5 Fixture	CA509/K5, K6, K8, K10, K12, K16	24 Strips	PL-34902001
K2 Fixture	CA509/K2, K3, K4, K20, K25, K2B4	24 Strips	PL-34902081
K5 Triple Fixture	CA509/K5, K6, K8, K10, K12, K16	72 Strips	PL-34130015
K9 Fixture	CA509/K9	24 Strips	PL-34902057
K2G Fixture	CA509/K2G	25 Strips	PL-34130010
Engraving Support Plate			PL-34902106

ENGRAVING NEEDLES



Engraving needles are selected depending on the media being engraved. For aluminium and other soft metal media, the double tooth cutter in various tip widths can be selected. For plastic media, engraving needles with a 15° angle needs to be used. Other engraving needle options are available on request.

Description	Tip Width	Part No.
Double Tooth Cutter for Plastic and Alluminium	0.50 mm	PL-35010030
Double Tooth Cutter for Plastic and Alluminium	0.60 mm	PL-35010031
Double Tooth Cutter for Plastic and Alluminium	0.80 mm	PL-35010032
Double Tooth Cutter for Plastic and Alluminium	1.00 mm	PL-35010033
Double Tooth Cutter for Plastic and Alluminium	1.20 mm	PL-35010034
Double Tooth Cutter for Plastic and Alluminium	1.40 mm	PL-35010035
Double Tooth Cutter for Plastic and Alluminium	1.60 mm	PL-35010036
Double Tooth Cutter for Plastic and Alluminium	2.00 mm	PL-35010037
Double Tooth Cutter for Plastic and Alluminium	2.40 mm	PL-35010038
Double Tooth Cutter for Plastic and Alluminium	3.00 mm	PL-35010039
Engraving Needle 15° for Plastic	0.20 mm	PL-35010003
Engraving Needle 15° for Plastic	0.30 mm	PL-35010002
Engraving Needle 15° for Plastic	0.40 mm	PL-35010001
Engraving Needle 15° for Plastic	0.50 mm	PL-35010000
Engraving Needle 15° for Plastic	0.70 mm	PL-35010004
Engraving Needle 15° for Plastic	1.00 mm	PL-35010005
Engraving Needle 15° for Plastic Set (0.20 - 1.00 mm)	-	PL-35010006

SCREW CLAMP TERMINAL BLOCK JUMPERS

Pre Assembled Jumpers



Insulated Pre Assembled Jumpers



Shorting / Bridging System for Polyamide Screw Clamp Terminal Blocks

The shorting systems bridge potentials between terminal blocks, reducing wiring time. Adjacent blocks or selective terminal blocks within an assembly can be easily interconnected, leaving terminal clamps free for wiring. Preassembled Jumpers, which are ready for installation, are used for quick shorting or individual components can be selected to create custom or extra long Jumpers. The current carrying capacity of shorting systems is lower than the rated current of the respective Terminal Blocks, therefore applied current must not exceed the maximum current value (IEC/EN) of the Terminal Block.

Preassembled Internal Jumpers assemblies

Internal Jumpers Assemblies consist of a Current Bar, Shorting Sleeves and screws. They install easily into the center of the terminal block and connect to the current bar. They are available as standard 2, 3, 4, 10 or 100 pole assemblies and are ready for immediate installation. Insulated preassembled internal Jumpers assemblies provide shock protection when installed on Terminal Blocks.

Insulated External Jumpers

External Jumpers bridge potentials between terminal blocks, reducing wiring time. Adjacent or selected blocks within an assembly can be easily interconnected. Individual links may be removed for selective shorting. These are insulated and available in 2, 3, 4 and 10 pole versions. They are made of tin plated brass/copper. Insulated External Link must be tightened to the recommended torque specified to get a reliable connection.

Permanent Jumpers

Jumpers are used to create custom shorting assemblies for increased number of poles. The current bar with the required number of poles can be selected, or can be cut in the field to the required length. They are made of tin or nickel plated copper or brass.

Shorting Sleeves & Screws

Shorting Sleeves & Screws ensure reliable and mechanically safe electrical connections between Jumpers and the Terminal Block current bars. One shorting sleeve is required for each shorted Terminal Block. They are made of nickel plated brass. Shorting Sleeve and Screws are supplied with spring washer. The shorting screws must be tightened to the recommended torque specified to get a reliable connection.

1 Internal shorting system not available.

2 100 pole strip can be broken down to any number of poles desired.

Terminal Series	Poles	Part No.	Torque	Std. Pack	Part No.	Torque	Std. Pack
CTS2.5UN	2	CA721/2	0.4 Nm	100	CA741/2	0.4 Nm	100
	3	CA721/3		100	CA741/3		100
	4	CA721/4		100	CA741/4		100
	10	CA721/10		10	CA741/10		10
	100 ²	CA721/100		10	CA741/100		10
CTS4UN CMC1-2 CMC2-2 CKT4U ¹ , 4U/4 CDL4UN CDL4UN(I.S)	2	CA722/2	0.4 Nm	100	CA742/2	0.4 Nm	100
	3	CA722/3		100	CA742/3		100
	4	CA722/4		100	CA742/4		100
	10	CA722/10		10	CA742/10		10
	100 ²	CA722/100		10	CA742/100		10
CTS6U CDTTU ¹ CDTTU-SH ¹ CSDL6U ¹ CSFL6U ¹	2	CA723/2	0.5 Nm	100	CA743/2	0.5 Nm	100
	3	CA723/3		50	CA743/3		50
	4	CA723/4		50	CA743/4		50
	10	CA723/10		10	CA743/10		10
	10(breakable)						
CTS10U	2	CA724/2	0.5 Nm	100	CA744/2	0.5 Nm	100
	3	CA724/3		50	CA744/3		50
	4	CA724/4		50	CA744/4		50
	10	CA724/10		10	CA744/10		10
CTS16U	2	CA751/2	0.8 Nm	50	CA761/2	0.8 Nm	50
	3	CA751/3		50	CA761/3		50
	4	CA751/4		50	CA761/4		50
	10	CA751/10		10	CA761/10		10
CTS25UN	2	CA725/2	0.8 Nm	50	CA745/2	0.8 Nm	50
	3	CA725/3		20	CA745/3		20
	4	CA725/4		20	CA745/4		20
	10	CA725/10		10	CA745/10		10
CTS35UN	2	CA771/2	0.8 Nm	50	CA781/2	0.8 Nm	50
	3	CA771/3		20	CA781/3		20
	4	CA771/4		20	CA781/4		20
	10	CA771/10		10	CA781/10		10
CMT4 CMB4 CDL4U CDL4U(I.S) ODL4U	2	CA727/2	0.4 Nm	100	CA747/2	0.4 Nm	100
	3	CA727/3		100	CA747/3		100
	4	CA727/4		100	CA747/4		100
	10	CA727/10		10	CA747/10		10
	100 ²						
CSDL4U ¹ DDFL4U / 4U(E) DDDL4U	2	CA729/2	0.5 Nm	100	CA749/2	0.5 Nm	100
	3	CA729/3		50	CA749/3		50
	4	CA729/4		50	CA749/4		50
	10	CA729/10		10	CA749/10		10
CSFL4U ¹ CSFL4U(L) ¹ CF4U ¹ / CF4U(L) ¹	2						
	3						
	4						
	10						
CAFL4U ¹ CAFL4U(L) ¹	2						
	3						
	4						
	10						
CTL2.5U CTL2.5UH CTL2.5UL CTL2.5UHL CTL2.5U(I.S)	2	CA722/2	0.4 Nm	100			
	3	CA722/3		50			
	4	CA722/4		50			
	10	CA722/10		10			
	100 ²	CA722/100		10			
10(breakable)							

Insulated External Jumpers



Permanent Jumpers



Shorting Sleeves & Screws



Part No.	Torque	Std. Pack
CA717/2	0.4 Nm	100
CA717/3		100
CA717/4		100
CA717/10		20
CA713/2	0.5 Nm	100
CA713/3		100
CA713/4		100
CA713/10		20
CA710/2	0.8 Nm	100
CA710/3		50
CA710/4		50
CA710/10		20
CA718/2	0.8 Nm	100
CA718/3		50
CA718/4		50
CA718/10		20
CA714/2	0.5 Nm	100
CA714/3		100
CA714/4		100
CA714/10		20
CA711/2	0.8 Nm	100
CA711/3		50
CA711/4		50
CA711/10		20
CA716/2	0.8 Nm	50
CA716/3		50
CA716/4		50
CA716/10		20
CA715/2	0.4 Nm	100
CA715/3		100
CA715/4		100
CA715/10		20

Part No.	Std. Pack
CA703/01	100
CA704/01	100
CA705/01	100
CA731/10	100
CA731/100	10
CA703/1	100
CA704/1	100
CA705/1	100
CA732/10	100
CA732/100	10
CA732/10-A	100
CA703/2	100
CA704/2	100
CA705/2	100
CA733/10	100
CA703/3	100
CA704/3	100
CA705/3	100
CA734/10	100
CA703/8	100
CA704/8	100
CA705/8	100
CA739/10	100
CA703/4	100
CA704/4	100
CA705/4	100
CA735/10	100
CA703/10	100
CA704/10	100
CA705/10	100
CA770/10	100
CA703/1	100
CA704/1	100
CA705/1	100
CA732/10	100
CA732/100	10
CA731/10-A	100
CA703/6	100
CA704/6	100
CA705/6	100
CA737/10	100
CA703/1	100
CA704/1	100
CA705/1	100
CA732/10	100
CA732/100	10
CA732/10-A	100

Part No.	Torque	Std. Pack
CA707/S/Q/01	0.4 Nm	100
CA707/S/Q/01	0.4 Nm	100
CA707/S/Q/1	0.5 Nm	100
CA707/S/Q/1	0.5 Nm	100
CA707/S/Q/1	0.8 Nm	100
CA707/S/Q/2	0.8 Nm	100
CA707/S/Q/2	0.8 Nm	100
CA607/S/Q	0.4 Nm	100
CA707/S/Q/3	0.5 Nm	100
CA707/S/Q/01	0.4 Nm	100

SCREW CLAMP TERMINAL BLOCK JUMPERS

Pre Assembled Jumpers



Insulated Pre Assembled Jumpers



Shorting / Bridging System for Polyamide Screw Clamp Terminal Blocks

The shorting systems bridge potentials between terminal blocks, reducing wiring time. Adjacent blocks or selective terminal blocks within an assembly can be easily interconnected, leaving terminal clamps free for wiring. Preassembled Jumpers, which are ready for installation, are used for quick shorting or individual components can be selected to create custom or extra long Jumpers. The current carrying capacity of shorting systems is lower than the rated current of the respective Terminal Blocks, therefore applied current must not exceed the maximum current value (IEC/EN) of the Terminal Block.

Preassembled Internal Jumpers assemblies

Internal Jumpers Assemblies consist of a Current Bar, Shorting Sleeves and screws. They install easily into the center of the terminal block and connect to the current bar. They are available as standard 2, 3, 4, 10 or 100 pole assemblies and are ready for immediate installation. Insulated preassembled internal Jumpers assemblies provide shock protection when installed on Terminal Blocks.

Insulated External Jumpers

External Jumpers bridge potentials between terminal blocks, reducing wiring time. Adjacent or selected blocks within an assembly can be easily interconnected. Individual links may be removed for selective shorting. These are insulated and available in 2, 3, 4 and 10 pole versions. They are made of tin plated brass/copper. Insulated External Link must be tightened to the recommended torque specified to get a reliable connection.

Permanent Jumpers

Jumpers are used to create custom shorting assemblies for increased number of poles. The current bar with the required number of poles can be selected, or can be cut in the field to the required length. They are made of tin or nickel plated copper or brass.

Shorting Sleeves & Screws

Shorting Sleeves & Screws ensure reliable and mechanically safe electrical connections between Jumpers and the Terminal Block current bars. One shorting sleeve is required for each shorted Terminal Block. They are made of nickel plated brass. Shorting Sleeve and Screws are supplied with spring washer. The shorting screws must be tightened to the recommended torque specified to get a reliable connection.

Terminal Series	Poles	Part No.	Torque	Std. Pack	Part No.	Torque	Std. Pack
CTS4USC CHV4U	2	CA623/2	0.4 Nm	100	CA643/2	0.4 Nm	100
	3	CA623/3		100	CA643/3		100
	4	CA623/4		100	CA643/4		100
	10	CA623/10		10	CA643/10		10
CTS6USC CHV6U	2	CA624/2	0.5 Nm	100	CA644/2	0.5 Nm	100
	3	CA624/3		50	CA644/3		50
	4	CA624/4		50	CA644/4		50
	10	CA624/10		10	CA644/10		10
CTS10USC CHV10U	2	CA625/2	0.5 Nm	100	CA645/2	0.5 Nm	100
	3	CA625/3		50	CA645/3		50
	4	CA625/4		50	CA645/4		50
	10	CA625/10		10	CA645/10		10
CDGL2.5 CTGL2.5	2	CA627/2	0.4 Nm	100			
	3	CA627/3		100			
	4	CA627/4		100			
	10	CA627/10		10			
PTB35/50 PTB35/50SH (Bolt type Shorting System)	2	CA703/9	3.0 Nm	10			
	3	CA704/9		10			
	4	CA705/9		10			
PTB70/95 PTB70/95SH (Bolt type Shorting System)	2	CA703/11	6.0 Nm	10			
	3	CA704/11		10			
	4	CA705/11		10			
CTS50/70N CTS50/70NA	2	CA628/2	3.0 Nm	10			
	3	CA628/3		10			
CTS95/120N	2	CA629/2	6.0 Nm	10			
	3	CA629/3		10			
CSB3U/N3U CSB3/N3UL CSB3U	2	CA728/2	0.4 Nm	100			
	3	CA728/3		100			
	4	CA728/4		100			
	10	CA728/10		10			
CBS4U CSB4/N4U CBS5U CSB5/N5U	2	CA772/2	0.4 Nm	100			
	3	CA772/3		100			
	4	CA772/4		100			
	10	CA772/10		10			
STH3	2	CA773/2	0.4 Nm	100			
	3	CA773/3		100			
	4	CA773/4		100			
	10	CA773/10		10			
STH3	2	CA774/2	0.4 Nm	100			
	3	CA774/3		100			
	4	CA774/4		100			

Insulated External Jumpers



Part No.	Torque	Std. Pack
----------	--------	-----------

Permanent Jumpers



Part No.	Torque	Std. Pack
----------	--------	-----------

Shorting Sleeves & Screws



Part No.	Torque	Std. Pack
----------	--------	-----------

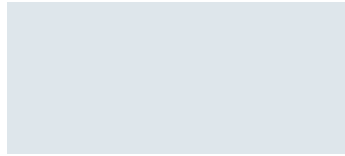
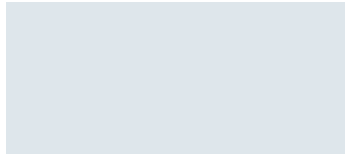
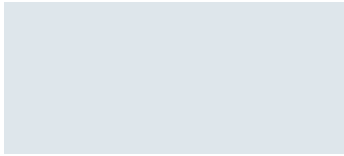

CA715/2	0.4 Nm	100
CA715/3		100
CA715/4		100
CA715/10		20

CA703/1		100
CA704/1		100
CA705/1		100
CA732/10		100

CA611/S/Q	0.4 Nm	100
-----------	--------	-----

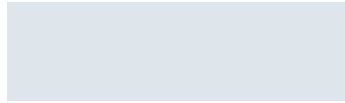
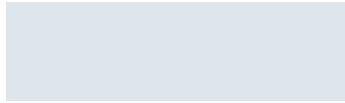
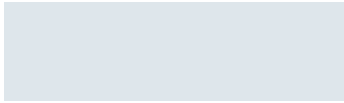
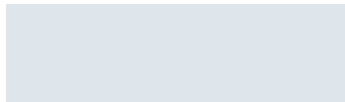
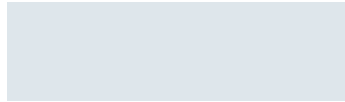
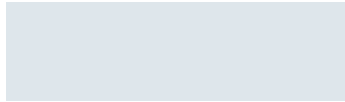
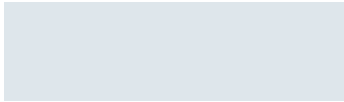

MELAMINE TERMINAL BLOCK JUMPERS

Preassembled Internal Jumpers assemblies

Internal Jumpers Assemblies consist of a Current Bar, Shorting Sleeves and screws. They install easily into the center of the Terminal Block and connect to the current bar. They are available as standard 2, 3, 4, 10 or 100 pole assemblies and are ready for immediate installation. Preassembled Insulated internal Jumpers assemblies provide shock protection when installed on Terminal Blocks.

Permanent Jumpers

These are used to create custom shorting assemblies for increased number of poles. The current bar with the required number of poles can be selected, or can be cut in the field to the required length. They are made of tin or nickel plated copper or brass.

Shorting Sleeves & Screws

Shorting Sleeves & Screws ensure reliable and mechanically safe electrical connections between Jumpers and the Terminal Block current bars. One shorting sleeve is required for each shorted Terminal Block. They are made of nickel plated brass.

Switchable Jumpers and Long Shorting Sleeves for temporary shorting

These links are used for switchable cross connection of adjacent Terminal Blocks of the same size. They can be used only in conjunction with the Long Shorting Sleeves and Screws.

STUD TYPE TERMINAL BLOCK JUMPERS

Shorting / Bridging System for Stud type Terminal Blocks

Fork Type Jumpers

These links have a possibility of quick insertion and removal. The entire nut assembly of the Terminal Block need not be removed for the insertion or removal of these links. They are available in standard 2, 3 or 4 pole configurations. They are also available in an insulated version which provides shock protection when installed on Terminal Blocks.

Ring Type Jumpers

These links provide a secure, permanent shorting possibility for stud type Terminal Blocks. They are available in standard 2, 3 or 4 pole configurations. They are also available in an insulated version which provides shock protection when installed on Terminal Blocks.

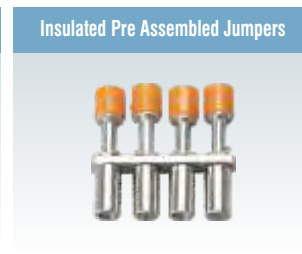

Terminal Series	Poles	Part No.	Torque	Std. Pack	Part No.	Torque	Std. Pack
CTS2.5(M)	2	CA521/2	0.4 Nm	100	CA621/2	0.4 Nm	100
	3	CA521/3		100	CA621/3		100
	4	CA521/4		100	CA621/4		100
	10	CA521/10		10	CA621/10		10
CTS2.5 CTS4SC	2	CA522/2	0.4 Nm	100	CA622/2	0.4 Nm	100
	3	CA522/3		100	CA622/3		100
	4	CA522/4		100	CA622/4		100
	10	CA522/10		10	CA622/10		10
CTS6 CTS6SC	2	CA723/2	0.5 Nm	100	CA743/2	0.5 Nm	100
	3	CA723/3		50	CA743/3		50
	4	CA723/4		50	CA743/4		50
	10	CA723/10		10	CA743/10		10
CTS10	2	CA724/2	0.5 Nm	100	CA744/2	0.5 Nm	100
	3	CA724/3		50	CA744/3		50
	4	CA724/4		50	CA744/4		50
	10	CA724/10		10	CA744/10		10
CTS16	2	CA751/2	0.8 Nm	50	CA761/2	0.8 Nm	50
	3	CA751/3		50	CA761/3		50
	4	CA751/4		50	CA761/4		50
	10	CA751/10		10	CA761/10		10
CTS35	2						
	3						
	4						
	10						

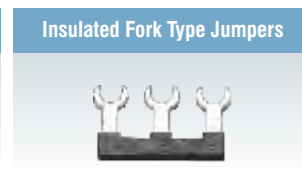
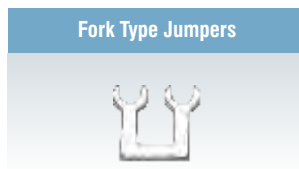

Terminal Series	Poles	Part No.	Torque	Std. Pack	Part No.	Torque	Std. Pack
CSTSB3	2	CA512/5-2	0.5 Nm	100	CA514/5-2	0.5 Nm	100
	3	CA512/5-3		50	CA514/5-3		50
	4	CA512/5-4		50	CA514/5-4		50
CSTSB4 / CSTSB5 CSTSB4/N4 CMDT4 / CMDT4SH	2	CA512/2-2	1.2 Nm	100	CA514/2-2	1.2 Nm	100
	3	CA512/2-3		50	CA514/2-3		50
	4	CA512/2-4		50	CA514/2-4		50
CSTSN4/N5 CSTSN4U/N5U CSTSB4U/B5U CBS4U/CSB4/N4U CBS5U/CSB5/N5U	2	CA512/1-2	1.2 Nm	100	CA514/1-2	1.2 Nm	100
	3	CA512/1-3		50	CA514/1-3		50
	4	CA512/1-4		50	CA514/1-4		50
	2	CA512/7-2	1.2 Nm	100	CA514/7-2	1.2 Nm	100
CSTSN6 CSTSN6U	3	CA512/7-3		50	CA514/7-3		50
	4	CA512/7-4		50	CA514/7-4		50
	2	CA512/9-2	1.2 Nm	100	CA514/9-2	1.2 Nm	100
CSTSN4(15) CSTSN5(15)	3	CA512/9-3		50	CA514/9-3		50
	4	CA512/9-4		50	CA514/9-4		50
CSTSRN5/RN6	2	CA512/11-2	1.2 Nm	50	CA514/11-2	1.2 Nm	50
STH4 STH4DT STH4DTSH	2	CA512/13-2	1.2 Nm	100	CA514/13-2	1.2 Nm	100
	3	CA512/13-3		50	CA514/13-3		50
	4	CA512/13-4		50	CA514/13-4		50
STH3/CSB3/ N3U CSB3U	2	CA512/15-2	0.5 Nm	100	CA514/15-2	0.5 Nm	100
	3	CA512/15-3		50	CA514/15-3		50
	4	CA512/15-4		50	CA514/15-4		50



Part No.	Std. Pack.
CA503/01	100
CA504/01	100
CA505/01	100
CA510/01	100

Part No.	Torque	Std. Pack.
CA507/S/Q/01	0.4 Nm	100

Part No.	Std. Pack.
CA506/01	100

Part No.	Torque	Std. Pack.
CA507/L/Q/01	0.4 Nm	100

CA503/1	100
CA504/1	100
CA505/1	100
CA510/1	100

CA707/S/Q/1	0.4 Nm	100
-------------	--------	-----

CA506/1	100
---------	-----

CA707/L/Q/1	0.4 Nm	100
-------------	--------	-----

CA703/2	100
CA704/2	100
CA705/2	100
CA733/10	100

CA707/S/Q/1	0.5 Nm	100
-------------	--------	-----

CA706/2	100
---------	-----

CA707/L/Q/1	0.5 Nm	100
-------------	--------	-----

CA703/3	100
CA704/3	100
CA705/3	100
CA734/10	100

CA707/S/Q/1	0.5 Nm	100
-------------	--------	-----

CA706/3	100
---------	-----

CA707/L/Q/1	0.5 Nm	100
-------------	--------	-----

CA703/8	100
CA704/8	100
CA705/8	100
CA739/10	100

CA707/S/Q/1	0.8 Nm	100
-------------	--------	-----

CA706/8	100
---------	-----

CA707/L/Q/1	0.8 Nm	100
-------------	--------	-----

CA503/5	100
CA504/5	100
CA505/5	100
CA510/5	100

CA508/S/Q	0.8 Nm	100
-----------	--------	-----

CA506/5	100
---------	-----

CA508/L/Q	0.8 Nm	100
-----------	--------	-----



Part No.	Torque	Std. Pack.
CA512/6-2	0.5 Nm	100
CA512/6-3		50
CA512/6-4		50

Part No.	Torque	Std. Pack.
CA514/6-2	0.5 Nm	100
CA514/6-3		50
CA514/6-4		50

Part No.	Torque	Std. Pack.

CA512/4-2	1.2 Nm	100
CA512/4-3		50
CA512/4-4		50

CA514/4-2	1.2 Nm	100
CA514/4-3		50
CA514/4-4		50

--	--	--

CA512/3-2	1.2 Nm	100
CA512/3-3		50
CA512/3-4		50

CA514/3-2	1.2 Nm	100
CA514/3-3		50
CA514/3-4		50

--	--	--

CA512/8-2	1.2 Nm	100
CA512/8-3		50
CA512/8-4		50

CA514/8-2	1.2 Nm	100
CA514/8-3		50
CA514/8-4		50

--	--	--

CA512/10-2	1.2 Nm	100
CA512/10-3		50
CA512/10-4		50

CA514/10-2	1.2 Nm	100
CA514/10-3		50
CA514/10-4		50

--	--	--

CA512/12-2	1.2 Nm	50
------------	--------	----

CA514/12-2	1.2 Nm	50
------------	--------	----

--	--	--

CA512/14-2	1.2 Nm	100
CA512/14-3		50
CA512/14-4		50

CA514/14-2	1.2 Nm	100
CA514/14-3		50
CA514/14-4		50

CA514/14-3A	1.2 Nm	10
CA514/14-4A		10

CA512/17-2	0.5 Nm	100
CA512/17-3		50
CA512/17-4		50

CA514/17-2	0.5 Nm	100
CA514/17-3		50
CA514/17-4		50

--	--	--

CX, CSC, CY, AS SERIES TERMINAL BLOCK JUMPERS



The possibility of using 2 independent rows for bridging enables the creation of various circuit combinations. Jumpers can be marked with a felt tip pen on the recess provided on top, to clearly indicate shorted positions.

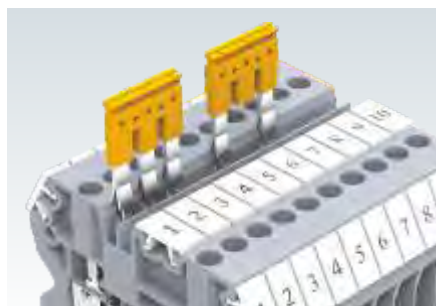

Individual Terminal Blocks in an assembly can be skipped from getting shorted with the adjacent terminal. This is achieved by breaking intermediate contacts from the standard jumpers.

STEP DOWN JUMPERS

These jumpers help in shorting Spring Clamp & Push-In Terminal Blocks of different sizes. CA801/8 and JXS Jumpers are used for shorting adjacent Terminal Blocks of different series.



Terminal Block		Part No.	I _{max}	Std. Pack.
CP1.5 & CPG1.5 Series	2 pole	JX1.5/2	16 A	100
CP1.5/3, CP1.5/4 Series	3 pole	JX1.5/3	16 A	50
CPG1.5/3, CPG1.5/4 Series	4 pole	JX1.5/4	16 A	50
CPDL1.5 Series	10 pole	JX1.5/10	16 A	10
CX2.5, CXG2.5 Series	2 pole	JX2.5/2	24 A	100
CXDL, CXDLG2.5 Series	3 pole	JX2.5/3	24 A	50
CXK2.5 Series	4 pole	JX2.5/4	24 A	50
CXM2.5, CXMG2.5	5 pole	JX2.5/5	24 A	50
CY2.5 Series	6 pole	JX2.5/6	24 A	10
	7 pole	JX2.5/7	24 A	10
	8 pole	JX2.5/8	24 A	10
	10 pole	JX2.5/10	24 A	10
CX4, CXG4 Series	2 pole	JX4/2	32 A	100
CXF, CXVF Series	3 pole	JX4/3	32 A	50
CXK4 Series, CY4 Series	4 pole	JX4/4	32 A	50
CYF, CYK, CYDLK Series	8 pole	JX4/8	32 A	10
	10 pole	JX4/10	32 A	10
CX6, CXG6 Series	2 pole	JX6/2	41 A	100
CXDB Series	3 pole	JX6/3	41 A	50
	4 pole	JX6/4	41 A	50
	10 pole	JX6/10	41 A	10
CY6, CYG6 Series	2 pole	JY6/2	41 A	100
	3 pole	JY6/3	41 A	50
	4 pole	JY6/4	41 A	50
	10 pole	JY6/10	41 A	10
CX10, CXG10 Series	2 Pole	JX10/2	57 A	20
CY10, CYG10 Series	2 Pole	JY10/2	57 A	20
ATL Series	2 pole	CA801/A2	24 A	100
	3 pole	CA801/A3	24 A	100
	4 pole	CA801/A4	24 A	100
	10 pole	CA801/A10	24 A	10
CSC16T	2 Pole	CA801/5	76 A	100
CSCP2.5T Series	2 Pole	CA803/1	24 A	100
AS2.5 Series	2 Pole Adjacent	CA801/1	24 A	100
	2 Pole Alternate	CA801/1-3	24 A	100
	2 Pole Wire Type	CA901/1	17.5 A	100
AS4 Series	2 Pole Adjacent	CA801/2	20 A	100
	2 Pole Alternate	CA801/2-3	20 A	100
	2 Pole Wire Type	CA901/2	17.5 A	100
AS6 Series	2 Pole Adjacent	CA801/3	35 A	100
	2 Pole Alternate	CA801/3-3	30 A	100
	2 Pole Wire Type	CA901/3	30 A	100

Terminal Block	Part No.	I _{max}	Std. Pack.
CX4/CP4 to CX2.5/CP2.5 Series Terminals	JXS4/2.5	24 A	50
CX6/CP6/10 to CX2.5/CP2.5 Series Terminals	JXS6/2.5	24 A	50
CX6/CP6/10 to CX4/CP4 Series Terminals	JXS6/4	32 A	50
CX10 to CX2.5 Series Terminals	JXS10/2.5	24 A	50
CX10 to CX6 Series Terminals	JXS10/6	24 A	50
AS6 Series to AS2.5 Series	CA801/8	24 A	100
AS6 Series to AS4 Series (Wire Type)	CA901/4	30 A	100
AS6 Series to AS2.5 Series (Wire Type)	CA901/5	24 A	100
AS4 Series to AS2.5 Series (Wire Type)	CA901/6	24 A	100

END PLATES

End Plates are used to cover the live parts of the last Terminal Block. They should be used at the end of an assembly of identical Terminal Blocks and whenever is changed in physical size of the Terminal Block.



Part No.	Std. Pack	Dimension (H x W x T)	Suitable for
EP2.5/4UN	50	32 x 39 x 1.5	CTS2.5UN/2.5UE/4UN/CTT2.5UK/T/J/E
EP6/10U	50	31 x 42.5 x 1.5	CTS6U/CTS10U
EPCMC1-2	50	35.5 x 46.5 x 2.5	CMC1-2
EPCMC2-2	50	40.5 x 65 x 2.5	CMC2-2
EPCDL4UN	50	47.5 x 57 x 1.5	CDL4UN/CDL4UN(I.S)
EPODL4U	50	49 x 68 x 5.5	ODL4U/ODL4UA(Front Side)
EP1ODL4U	50	24 x 68 x 3	ODL4U/ODL4UA(Back Side)
EPODL2.5	50	55 x 59 x 4.6	ODL2.5 Series
EP1ODL2.5	50	24 x 59 x 2.5	ODL2.5 Series
EPCDGL2.5	50	48 x 71.4 x 1.2	CDGL2.5
EPCTL2.5U	50	55.5 x 84 x 1.5	CTL2.5U/2.5UL/2.5U(I.S)
EPCTL2.5UH	50	55.5 x 61 x 1.5	CTL2.5UH/2.5UH(L)/2.5UH(I.S)D2
EPCTLG2.5	50	62.5 x 87.5 x 1.2	CTGL2.5/CTGL2.5(E)MOV
EPCMT4	50	23 x 27 x 1.5	CMT4
EPCMB4	50	27 x 27 x 7	CMB4
EPCBS3U	50	26.2 x 49 x 1.5	CBS & CSB Series
EPCAF4U	25	32 x 72 x 1.5	CAFL4U/4UL/4UN
EPDDL4U	25	49 x 87.6 x 3	DDFL4U/4ULR/4U(E)/4U(E)LR
EPCDTTU	50	41 x 63 x 3	CDTTU/CDTTUSH
EPCKT4U	50	30.5 x 46.5 x 2.5	CKT4U
EPCKT4U/4	50	65 x 38.3 x 1.5	CKT4U/4
EPCDS6U	50	37.2 x 82 x 1.5	CDS6U/6UTS/6UFT/6USC
EPCGT4U	50	40.5 x 43 x 1	CGT4U
EPUSC	50	52 x 48.5 x 1.5	CTS4USC/6USC/10USC/CHV4U/6U/10U
EPCTC4U	50	34.5 x 47 x 2.5	CTC4U
EPCSTSU	50	31 x 50 x 1.5	CSTSN4U/N5U/N6U/B4U/B5U
EPSTH3	50	34.4 x 47 x 1.5	STH3
EPSTH4	50	39.5 x 46 x 1.5	STH4
EPSTH6	50	51 x 63.5 x 2	STH6
EPSTH4DT	50	37.5 x 86 x 1.5	STH4DT / STH4DTSH
EPCSC16T	50	82 x 38 x 1.5	CSC16T/CSCG16T
EPCSCP2.5T(L&R)	50	27.3 x 35 x 5	CSCP2.5T/CSCP2.5T2
EPAS2.5	50	35 x 54 x 1.5	AS2.5, 2.5/3, 2.5/4, AGT2.5, 2.5/3, 2.5/4
EPAS4	50	27.5 x 61 x 1.5	AS4, 4/3, 4/4, AGT4, 4/3, 4/4
EPAS6	50	33.5 x 74 x 1.5	AS6, 6/3, AGT6, 6/3
EPADLG2.5	50	83.75 x 58 x 1.2	ADLG2.5
EPATL2.5	50	100 x 69.7 x 1.2	ATL2.5
EPATL2.5H	50	77.3 x 69.7 x 1.2	ATL2.5H
EPATLG2.5	50	100 x 68.75 x 1.2	ATLG2.5
CTSEP01	50	31 x 36.5 x 1.8	CTS2.5(M)
CTSEP1	50	49 x 40 x 2.7	CTS2.5/6/10/4SC/6SC
CTSEP2	50	54 x 49.5 x 3	CTS16
CTSEP3	25	52 x 58 x 2.7	CTS35
CTSEP1SC	50	43.5 x 50 x 2.5	CTS10SC
CSTSEP2	50	44.5 x 50 x 3	CSTSB3/B4/B5/N4/N5/N4(15)/N5(15)/N6
CSTSRN5	50	48.5 x 43 x 3	CSTSRN5/CSTSRN6
EPCMDT4	50	48.7 x 68 x 2.4	CMDT4/CMDT4SH
EPCX2.5	50	30.5 x 49.7 x 1.5	CX2.5 / CXG2.5
EPCX2.5/3	50	30.5 x 62.2 x 1.5	CX2.5/3 / CXG2.5/3 / CXK2.5
EPCX2.5/4	50	30.5 x 74.7 x 1.5	CX2.5/4 / CXG2.5/4 CXK2.5/4 / CX2.5/4P
EPCX4	50	30.5 x 54.8 x 1.5	CX 4 / CXG4
EPCX4/3	50	30.5 x 70.5 x 1.5	CX4/3 / CXG4/3 / CXK4
EPCX4/4	50	30.5 x 86.2 x 1.5	CX4/4 / CXG4/4 / CXK4/4
EPCX6	50	35.3 x 62.1 x 1.5	CX6 / CXG6
EPCX6/3	50	35.3 x 82.2 x 1.5	CX6/3 / CXG6/3
EPCX10	50	41.6 x 70 x 1.5	CX10 / CXG10
EPCX10/3	50	41.6 x 95.3 x 1.5	CX10/3 / CXG10/3
EPCXDL2.5	50	41.8 x 72.7 x 1.5	CXDL2.5 Series
EPCXS2.5	50	35.6 x 43 x 1.5	CXS2.5 / CXSG2.5 / CXS4 / CXSG4
EPCM1.5S	50	18 x 26.5 x 12	CM1.5S / CM1.5S2
EPCM2.5S	50	20 x 30 x 12.45	CM2.5S / CM2.5S2
EPCM4S	50	23 x 33.7 x 14.5	CM4S / CM4S2
EPCMS2.5	50	25 x 31 x 1.5	CMS2.5
EPCX2.5SN	50	36.8 x 15.9 x 0.5	CX2.5SN

END PLATES

End Plates are used to cover the live parts of the last Terminal Block. They should be used at the end of an assembly of identical Terminal Blocks and whenever is changed in physical size of the Terminal Block.

Part No.	Std. Pack	Dimension (H x W x T)	Suitable for
EPCXM2.5	50	29.5 x 37 x 1.5	CXM2.5 / CXMG2.5
EPCXCP2.5	50	27.3 x 35 x 3	CXCP2.5/4
EPCP3L2.5	30	98.70 x 83 x 1.5	CP3L2.5 Series
EPCP4LG2.5	30	118.6 x 93 x 1.5	CP4LG2.5
EPCP1.5	50	26.35 x 45.3 x 1.5	CP1.5 / CPG1.5
EPCP1.5/3	50	26.35 x 54.4 x 1.5	CP1.5/3 / CPG1.5/3
EPCP1.5/4	50	26.35 x 63.5 x 1.5	CP1.5/4 / CPG1.5/4
EPCPDL1.5	50	37.55 x 67.2 x 1.5	CPDL1.5 Series
EPCPDLK2.5	50	107 x 38.1 x 1.5	CPDLK2.5 Series
EPCPPT2.5/3	50	79.8 x 40.3 x 1.5	CPPT & CPST Series
EPCPPT2.5/3	50	96.5 x 40.3 x 1.5	CPPT & CPST Series
EPCYDL2.5/4	50	58.1 x 69.5 x 1.5	CYDL Series
RBCP8L32	50	59.5 x 35.8 x 8.1	CP8L32 & CP8L32(I.S)
EPCY2.5/10	50	41.35 x 50 x 1.5	CY2.5 to CY10 Series

PARTITION PLATES

Partition Plates are used to segregate different groups of Terminal Blocks and provide the required creepage and clearance values in an assembly. Partition Plates electrically isolate adjacent Jumpers. They also provide a separation between Terminal Blocks of different potentials.

For visual separation of different circuits, a choice of coloured End Plates and Partition Plates are also available.

Part No.	Std. Pack	Dimension (H x W x T)	Suitable for
PP2.5/4UN	50	37 x 44 x 1.6	CTS2.5UN/2.5UE/4UN/CTT2.5UK/T/J/E
PP6/10U	50	37.5 x 56 x 1.5	CTS6U/CTS10U
PP25UN	50	42.5 x 62 x 1	CTS25UN
PP35UN	50	50 x 64.5 x 1	CTS35UN
PPCMT4	50	32 x 37 x 1.6	CMT4
PPCSFL4U	50	42.5 x 62 x 1.5	CSFL4U/4U(L)/CSDL4U
CTSP01	50	43.5 x 49 x 2.3	CTS2.5(M)
CTSP1L	50	63 x 40 x 2.8	CTS2.5/6/10/4SC/6SC
CTSP1B	50	60 x 55 x 3	CTS2.5/6/10/4SC/6SC
CTSP2	50	66.5 x 66 x 3	CTS16
CTSP3	25	59 x 67.5 x 3	CTS35
CTSP1SC	50	48 x 60 x 3	CTS10SC
CMSTPP	50	23 x 27 x 1.5	CMST1/CMST2
CSTSP	20	53 x 60 x 3	CSTSB3/B4/B5/N4/N5/N4(15)/N5(15)/N6
EP4P	10	70 x 160 x 2	CTS35L/70L/95L/35LS/70LS/95LS
CTSEP4	50	5 x 120 x 2.5	CTS35L/70L/35LS/70LS
PPCBB	10	45 x 120 x 2	CBB35/50 / CBB70 / CBB95
PPCBB1	10	65 x 180 x 2	CBB120 / CBB150 / CBB185
PPCX4	50	42.4 x 59 x 2	CX2.5 / CXG2.5 / CX4 / CXG4
PPCX4/3	50	42.4 x 74.7 x 2	CX2.5/3 / CXG2.5/3 / CXK2.5 / CXK4/3 / CXK4
PPCX4/4	50	42.4 x 95 x 2	CX2.5/4 / CXG2.5/4 / CX4/4 / CXK4/4
PPCX10	20	53.5 x 76 x 2	CX6 / CX10
PPCYDL2.5/4	20	70.1 x 79.5 x 2	CYDL Series
PPCY2.5/10	50	52.35 x 60 x 2	CY2.5 to CY10 Series

SEPARATOR PLATES

Separator Plates are used for electrical separation of adjacent Jumpers without the use of additional space. They can be inserted after the Terminal Blocks have been assembled on the DIN rail.

Part No.	Std. Pack	Dimension (H x W x T)	Suitable for
SP2.5/4UN	100	17.5 x 17.4 x 1.4	CTS2.5UN/2.5UE/4UN/CTT2.5UK/T/J/E
SP6/10U	100	15.4 x 16.2 x 1.5	CTS6U/CTS10U/CTS16U
SPCDL4U	100	15.4 x 16.2 x 1.6	CDL4U/4UN/CDL4U(I.S)/4UN(I.S)
SPCMB4	100	14.5 x 12 x 1.5	CMB4
SPCDLG2.5	100	11 x 10.5 x 1	CDGL2.5
SPCP8L32	10	83.2 x 120 x 3.5	CP8L32 & CP8L32(I.S)

PROTECTIVE COVERS

For protection against dust and shock, transparent protective covers can be installed above the Terminal Block assembly. The protective cover is held in place with the help of a fixing nut on the support plate CSP1. The protective cover is held in place with the help of a fixing nut on the support plate CSP1. Support Plate CSP1 can be mounted on all DIN rails. It is advised to use standard end clamps / stops to hold the CSP1 in place.

Protective Covers



Part No.	Length	Std. Pack
CTSPC(40mm)	40 mm	10
CTSPC(90mm)	90 mm	10
CTSPC(100mm)	100 mm	10
CTSPC(130mm)	130 mm	10
CTSPC(150mm)	150 mm	10
CTSPC(200mm)	200 mm	10
CTSPC(240mm)	240 mm	10
CTSPC(300mm)	300 mm	10
CTSPC(330mm)	330 mm	10
CTSPC(430mm)	430 mm	10
CTSPC(460mm)	460 mm	10
CTSPC(760mm)	760 mm	10

Support Plate

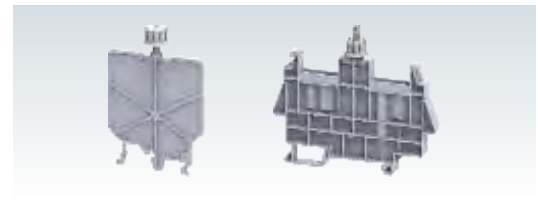

Part No.	Std. Pack
CSP1	100
CSP2	100
GMH9	100

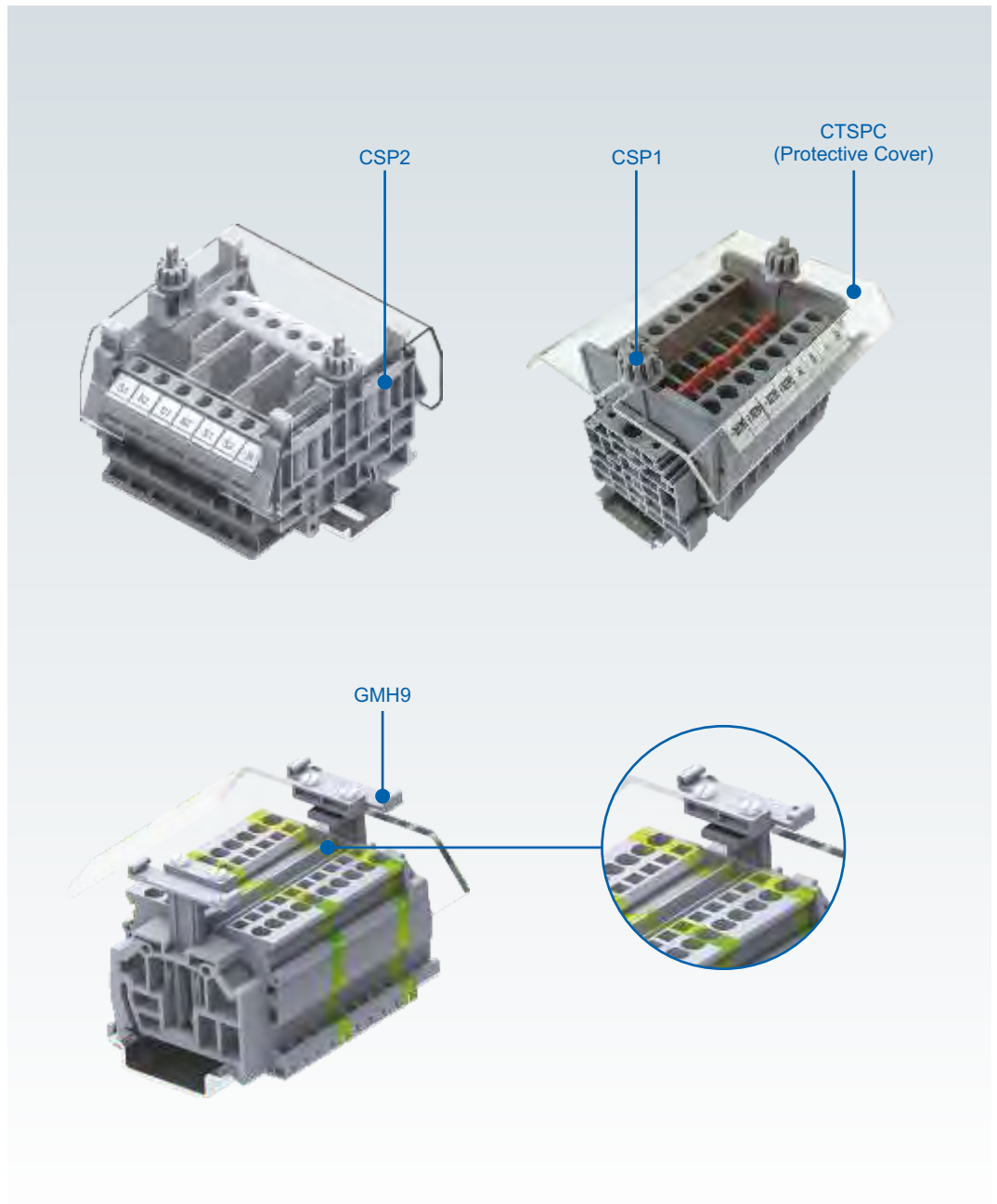

PROFESSIONAL TOOLS

In order to have secure connections, not only it is important to use good quality terminal blocks but also correct tools for securing these connections. Connectwell has a range of ergonomically designed professional tools for all your wiring needs. The tri-moulded handles of these screwdrivers allow the users to exert 50% additional torque over conventional screwdrivers. All this and more to ensure that you have The Right Connection.



Tri-Molded PROFESSIONAL Screwdrivers

Material 1



Specially formulated hard material prevents blades from turning. Handles are injection moulded around blades for maximum strength and durability.

Material 2

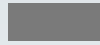

Soft TPE material, specially formulated for best torque transmission. It has an integrated diamond pattern area for better hand grip and air ventilation between the hand and the handle.

Material 3



Specially formulated reinforced material, impact resistant even at lower temperatures to prevent handle damage.

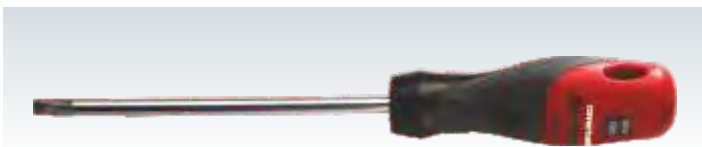
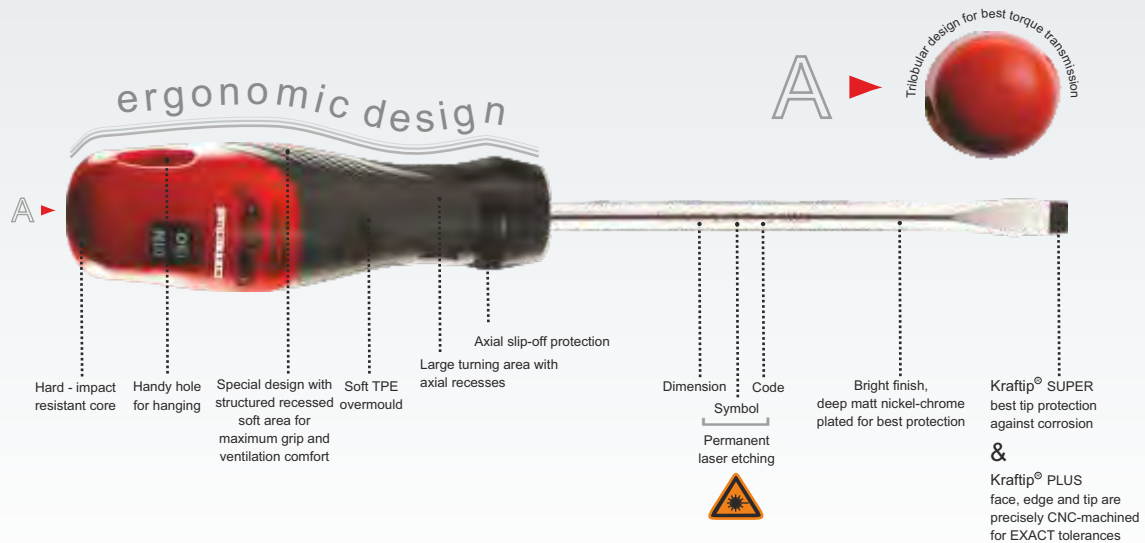

Electrician's Screwdrivers

Application: for slotted screws ISO 2380

Blade type: round blade, high-grade chrome-vanadium-molybdenum steel, chrome plated

Tip: Kraftip Plus black tip, ISO 2380-1

Handle: Three component handle, Kraftgrip 50000R

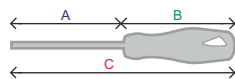

Cat. No.	EAN	⌀	↕	A	B	C	↔	Pack Pcs.
SCS0.5/3	6	0.5	3.0	100	85	185	3.0	10
SCS0.6/3.5	3	0.6	3.5	100	85	185	3.5	10
SCS0.8/4	0	0.8	4.0	125	85	210	4.0	10
SCS1/5.5	7	1.0	5.5	150	100	250	5.5	10

Electrician's Screwdrivers Insulated

Application: for slotted screws EN 60900:2004

Blade type: round blade, insulated high-grade chrome-vanadium-molybdenum steel, black finish

Tip: Kraftip Plus black tip, ISO 2380-1

Handle: Three component handle, Kraftgrip 50000R

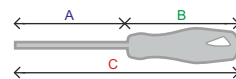

Cat. No.	EAN	⌀	↕	A	B	C	↔	Pack Pcs.
SCS0.5/3I	3	0.5	3.0	100	85	185	3.0	10
SCS0.6/3.5I	0	0.6	3.5	100	85	185	3.0	10
SCS0.8/4I	7	0.8	4.0	100	85	185	3.5	10
SCS1/5.5I	4	1.0	5.5	125	100	225	5.0	10



Application:

Phillips Screwdrivers

Application: for Phillips Recess screws ISO 8764

Blade type: round blade, high-grade chrome-vanadium-molybdenum steel, chrome plated

Tip: Kraftip Plus black tip, ISO 8764-1

Handle: Three component handle, Kraftgrip 50000R

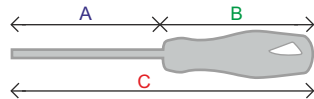

Cat. No.	EAN	+	A	B	C	→●←	Pack Pcs.	
SCPH1	5	PH	1	80	100	180	4.5	10
SCPH2	2	PH	2	100	110	210	6.0	10

AC 1000V



Phillips Screwdrivers Insulated

Application: for Phillips Recess screws EN 60900:2004

Blade type: round blade insulated, high-grade chrome-vanadium-molybdenum steel, black finish

Tip: Kraftip Plus black tip, ISO 8764-1

Handle: Three component handle, Kraftgrip 50000R

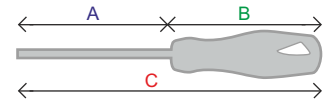

Cat. No.	EAN	+	A	B	C	→●←	Pack Pcs.	
SCPH2I	2	PH	2	100	110	210	6.0	10



Socket wrench-NUT DRIVER

Application: for hexagon headed screws, bolts and nuts DIN 3125

Blade type: round blade, with deep hexagonal socket, high-grade chrome-vanadium-molybdenum steel, chrome plated

Handle: Three component handle, Kraftgrip 50000

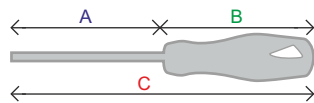

Cat. No.	EAN	⊙	Nut Size	A	B	C	→●←	Pack Pcs.
SCNT4	0	SW 4	M2	125	100	225	6	10
SCNT5	7	SW 5	M2.5	125	100	225	6	10
SCNT6	1	SW 6	M3	125	110	235	6	10



Mechanic's Screwdrivers

Application: for slotted screws ISO 2380

Blade type: round blade, high-grade chrome-vanadium-molybdenum steel, chrome plated

Tip: Kraftip Plus black tip, ISO 2380-1

Handle: Three component handle, Kraftgrip 50000R

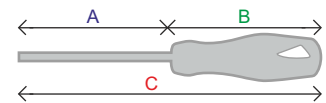

Cat. No.	EAN	⊖	⊕	A	B	C	→●←	Pack Pcs.
SCM0.4/2.5	5	0.4	2.5	75	85	160	2.5	10
SCM0.5/3	2	0.5	3.0	100	85	185	3.0	10
SCM0.8/4	6	0.8	4.0	100	85	185	4.0	10
SCM1/5.5	3	1.0	5.5	125	100	225	5.0	10

RoHS COMPLIANCE

The RoHS (Restriction of Hazardous Substances) Directive 2011/65/EU dated 8th June 2011 addresses the restriction of the use of certain hazardous substances in electrical and electronic equipment.

Producers of certain categories of electrical and electronic equipment cannot use high levels of the following six banned substances:

Lead (Pb)

Mercury (Hg)

Polybrominated biphenyls (PBB) [flame retardant]

Hexavalent chromium (Cr-VI)

Cadmium (Cd)

Polybrominated diphenyl ether (PBDE) [flame retardant]

On 4 June 2015, the EU commission has published a new Directive (EU) 2015/863 to amend Annex II to EU RoHS 2 (Directive 2011/65/EU) to add the following 4 phthalates onto the list of restricted substances

Bis(2-Ethylhexyl) phthalate (DEHP)

Dibutyl phthalate (DBP)

Benzyl butyl phthalate (BBP)

Diisobutyl phthalate (DIBP)

REACH COMPLIANCE

REACH is the regulation (EC) No 1907/2006 of the European Parliament and of the Council of 18, concerning the **R**egistration, **E**valuation, **A**uthorization and **R**estriction of **C**hemicals.

Implemented on 1st June 2007, **REACH** requires the registration of some 30000 chemical substances (over a period of 11 years) in use today, a process which will allow to fill information gaps on the hazards of substances and to identify appropriate risk management measures to ensure their safe use.

European chemical agency (ECHA) has listed various **S**ubstances of **V**ery **H**igh **C**oncern (**SVHC**). Less than 0.1% or less than 1000 ppm of **SVHC** will be allowed in REACH compliant products.



All Connectwell Terminal Blocks are
RoHS & REACH Compliant.

DIN RAIL MOUNTED SOCKETS & SWITCHES



Connectwell DIN Rail mounted socket and switches offer a unique possibility of mounting an Industrial Socket and Switch on a standard DIN rail.

Sockets are available for various country standard plugs. These need to be wired and snapped inside the Din rail mounting frame as shown in the assembly diagram below.

This assembly then easily snaps on to a standard DIN rail.

Switches CDINSW1 & CDINSW2 are available in single and double pole configuration respectively.



Dimension W x L x H	53 x 82 x 60 mm													
Socket Housing Material	Polycarbonate													
DIN Rail Frame Material	ABS													
Wire Clamp & Contact Material	Brass													
Electrical Data														
Rated Connecting Capability	0.5 - 2.5 sq.mm													
Voltage Rating	250 V													
Current Rating	5 A													
Suitable for Plugs	Type C, Type D (Indian Standard BS546)													
Approvals														
<table border="1"> <thead> <tr> <th>Type / Cat. No.</th> <th>Std. Pack</th> </tr> </thead> <tbody> <tr> <td>CDINS6</td> <td>5</td> </tr> <tr> <td>CA701-1M / CA701-1M-S</td> <td>50 m</td> </tr> <tr> <td>CA701-15-1M / CA701-15-1M-S</td> <td>50 m</td> </tr> <tr> <td>CA102</td> <td>50</td> </tr> <tr> <td>CA202</td> <td>50</td> </tr> </tbody> </table>			Type / Cat. No.	Std. Pack	CDINS6	5	CA701-1M / CA701-1M-S	50 m	CA701-15-1M / CA701-15-1M-S	50 m	CA102	50	CA202	50
Type / Cat. No.	Std. Pack													
CDINS6	5													
CA701-1M / CA701-1M-S	50 m													
CA701-15-1M / CA701-15-1M-S	50 m													
CA102	50													
CA202	50													
DIN Rail Socket														
Mounting Rail (Refer Pg. 216 for details)														
End Clamp (Refer Pg. 217 for details)														
Applicable Countries *	Afghanistan, Bangladesh, India, Nepal, Nigeria, Pakistan, Qatar, Sri Lanka													

* Country data may vary. Please check the country socket configuration before ordering.

ASSEMBLY INSTRUCTIONS

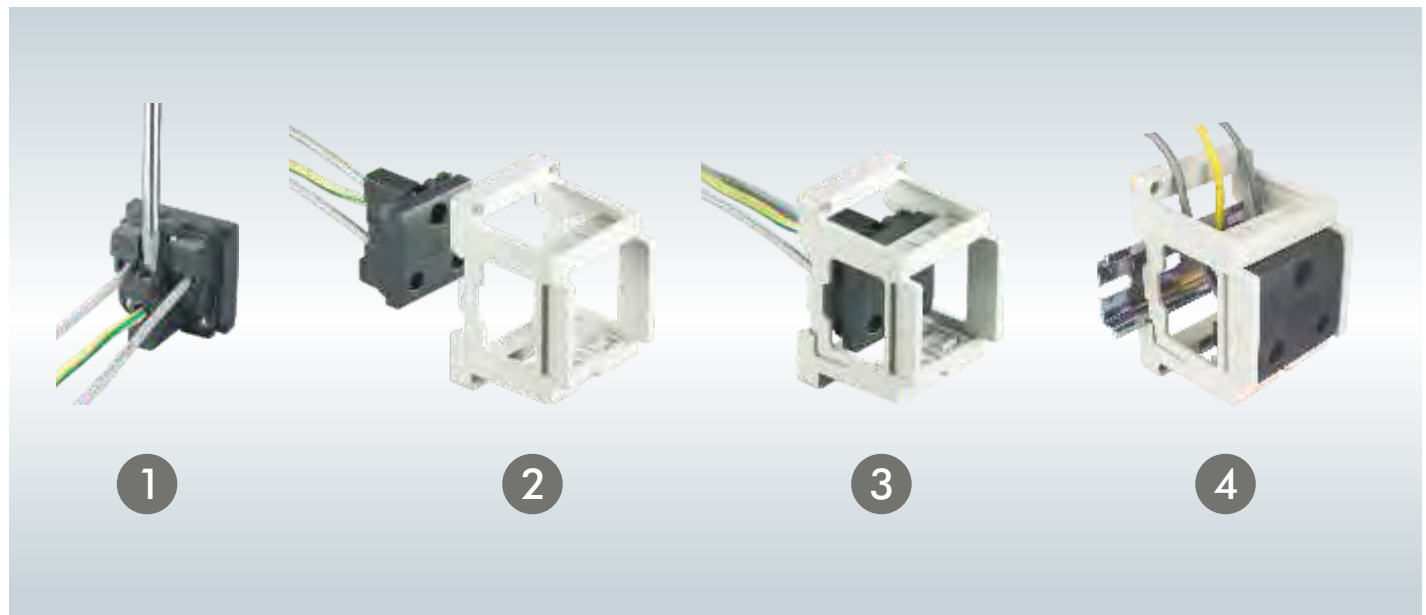

CDINS16



53 x 82 x 60 mm

Polycarbonate

ABS

Brass

0.5 - 2.5 sq.mm

250 V

13 A

Type M (South African Standard)



Type / Cat. No.	Std. Pack
CDINS16	5
CA701-1M / CA701-1M-S	50 m
CA701-15-1M / CA701-15-1M-S	50 m
CA102	50
CA202	50

Bangladesh, India, Nepal, Pakistan, Qatar, Sri Lanka, South Africa

CDINSUK



53 x 82 x 60 mm

Polycarbonate

ABS

Brass

0.5 - 2.5 sq.mm

250 V

13 A

Type G (UK Standard BS1363)



Type / Cat. No.	Std. Pack
CDINSUK	5
CA701-1M / CA701-1M-S	50 m
CA701-15-1M / CA701-15-1M-S	50 m
CA102	50
CA202	50

Bahrain, Hongkong, Iraq, Ireland, Jordan, Kenya, Kuwait, Lebanon, Macau, Malaysia, Mauritius, Myanmar, Nigeria, Oman, Qatar, Saudi Arabia, Singapore, United Arab Emirates, United Kingdom, Yemen, Zimbabwe

CDINS D



53 x 82 x 60 mm

Polycarbonate

ABS

Brass

0.5 - 2.5 sq.mm

250 V

13 A

Type F (Schuko)



Type / Cat. No.	Std. Pack
CDINS D	5
CA701-1M / CA701-1M-S	50 m
CA701-15-1M / CA701-15-1M-S	50 m
CA102	50
CA202	50

Algeria, Austria, Bosnia, Bulgaria, Finland, France, Germany, Greece, Hungary, Iceland, Indonesia, Italy, Jordan, Luxembourg, Monaco, Myanmar, Netherlands, Norway, Portugal, Romania, Serbia, Spain, Turkey

CDINSW1



Dimension W x L x H

Switch Housing Material

DIN Rail Frame Material

Wire Clamp & Contact Material

Electrical Data

Rated Connecting Capability

Voltage Rating

Current Rating

Number of Poles

Approvals

DIN Rail Socket

Mounting Rail (Refer Pg. 216 for details)



End Clamp (Refer Pg. 217 for details)



53 x 82 x 60 mm

Polycarbonate

ABS

Brass

0.5 - 2.5 sq.mm

250 V

16 A

1



Type / Cat. No.	Std. Pack
CDINSW1	5
CA701-1M / CA701-1M-S	50 m
CA701-15-1M / CA701-15-1M-S	50 m
CA102	50
CA202	50

CDINSW2



53 x 82 x 60 mm

Polycarbonate

ABS

Brass

0.5 - 2.5 sq.mm

250 V

16 A

2



Type / Cat. No.	Std. Pack
CDINSW2	5
CA701-1M / CA701-1M-S	50 m
CA701-15-1M / CA701-15-1M-S	50 m
CA102	50
CA202	50



ATEX-IECEX Approved Terminal Blocks

The ATEX - IECEX Directive besides taking into account the electrical sources of explosion, also considers potentially explosive concentrations of gas, vapor or mist along with dust in the air.

Note: When specific ATEX - IECEX / AEX / In Metro approved Terminal Blocks are required, please specifically mentioned this in your purchase orders. Such orders will be processed with due consideration.

Connectwell Terminal Blocks having ATEX - IECEX approval will be marked as follows:

ATEX-IECE_x APPROVED TERMINAL BLOCKS

Condition of Safe Use – increased safety "e"

The Terminal Blocks are suitable to mount on DIN35/ DIN32/ DIN15 as applicable.
The Terminal blocks are suitable for use in ATEX / IECEx certified enclosure with minimum IP rating of IP 54.

The terminal block has to be built into the enclosure with the type of protection "4" (complying with IEC/EN60079-31)" standard when placed in dust atmosphere.

The terminal blocks are suitable for maximum service temperature 85°C, considering the self-heating when used at rated current with specified maximum conductor size & at ambient temperature range of -40°C to +40°C at mounting position.

When the Terminal Blocks are used in electrical apparatus, the highest temperature of the insulating material shall not exceed the max value of the temperature 85 °C.

When these terminal blocks are mounted, the minimum creepage and clearance distances shall be maintained for respective voltage rating, with neighboring terminal blocks.

Proper care should be taken for stranded wire type of connection in terminal blocks, so that conductors do not get damaged while installation.

Installation instruction - Intrinsic Safety "i"

IEC/EN 60079-14 Clause 12 states Modular Terminal Blocks as simple apparatus when used in intrinsically safe circuits. Testing by a notified body and marking is not required. If Terminal Blocks are identified as part of an intrinsically circuit are marked by a colour, the colour used shall be light blue. Testing for compliance to intrinsically safe requirements including clearance, creepage, and solid insulation distances specified in IEC/EN 60079-0 and IEC/EN 60079-11 have been performed for circuits up to 60 V. Compliance with distance requirements of IEC/EN 60079-14 Clause 12.2.3 for the connection of separated intrinsically safe circuit accessories is met. A minimum distance of 50 mm to separate clamping units of intrinsically safe and non-intrinsically safe circuits is required by using a partition plate or spacer or similar device.

Schedule of Limitations:

1) When these terminal blocks are mounted, the minimum creepage and clearance distances with neighbouring terminal blocks and between the current bar & DIN-Rail shall be maintained as per the table given below:-

VOLTAGE (V)	CREEPAGE(mm)	CLEARANCE(mm)
1250	22	18
1000	20	14
800	16	12
630	12	10
500	10	8
400	8	6
320	6.3	6

- 2) To avoid the risk of short-circuits between adjacent conductors in terminal blocks; the insulation of each conductor shall be maintained up to the metal of the terminal.
- 3) All terminal screws and nuts used shall be tightened down wherever applicable as per the torque values specified in the table on page 2.
- 4) When this product is intended to be used in a potentially explosive dust atmosphere, it shall be installed in an enclosure that is suitably certified for use in that environment.
- 5) The housing material of the terminal blocks is not rated for UV protection. The terminal blocks are not to be installed in an enclosure with a glass or transparent plastic window or cover unless suitable protected against direct sunlight.
- 6) When used in intrinsically safe circuits, the terminals shall not be used for voltages above 60 V peak.
- 7) Where the terminals of intrinsically safe and non-intrinsically safe circuits are in the same enclosure, measures shall be taken to maintain at least 50 mm separation, using a spacer or similar device. Alternatively, a partition meeting the requirements of the relevant code of practice (e.g. IEC 60079-14) shall be used.
- 8) When used as part of an intrinsically safe circuit, terminal blocks shall meet the requirements for a T4 temperature class at 85°C ambient.
- 9) When the device is mounted in a hazardous area, connection and disconnection of the device from the rail while live is only permitted if the potentially explosive atmosphere is shown to be absent. This restriction does not apply if the circuit is intrinsically safe.
- 10) When used as part of an intrinsically safe circuit, terminal blocks shall be marked with a light blue colour or otherwise indicated that the circuits are intrinsically safe.

For Fuse & Disconnecting Terminal Block

- 11) The supply must be switched off before lifting the fuse carrier from base terminal. (Do not actuate the disconnecting knife or fuse carrier when energized). Do not replace or remove the fuse when energized.
- 12) Fuse terminals: The replacement fuses shall be, either FSF series manufactured by Schurter, or PSF series manufactured by Protection. The size of the fuse is Ø 5 X 20mm. The fuse shall be selected so that it is used within the manufacturers' ratings: breaking capacity, rated current and voltage rating. The rated current shall not exceed 6.3A.
- 13) Fuse terminals: The fuse shall not be removed or replaced when energized.
- 14) Ex ic fuse terminals shall only be mounted inside a suitably-certified flameproof enclosure.
- 15) Disconnect terminals shall only be operated when the circuit is electrically isolated. This restriction does not apply if the circuit is intrinsically safe.
- 16) Fuses shall be marked either as increased safety or intrinsically safe, but not both. Terminals that are marked as intrinsically safe shall be light blue.

ATEX-IECE_x APPROVED TERMINAL BLOCKS

Marking :

For increased safety 'e'

Sira 16ATEX3028U
0518  II 2G Ex eb IIC Gb

For intrinsic safety 'i'

Sira 16ATEX3028U
0518  II 2G Ex ib IIC Gb

IECE_x SIR 16.0016U
Ex eb IIC Gb

IECE_x SIR 16.0016U
Ex ib IIC Gb

Ambient Temperature range : -40°C to +40°C
Service Temperature range : -40° C to +85°C

Insulation Material: Polyamide 66, CTI 600 / Material Group I.

Terminal Block	Increased Safety 'e' Voltage (V)	Current (A)	Wire Size (sq.mm)	Intrinsic Safety 'i' Voltage (V)	Stripping Length (mm)	Torque (Nm)
CX2.5	630	21	0.2 - 2.5	60	10	N.A.
CX2.5/3	630	21	0.2 - 2.5	60	10	N.A.
CX2.5/4	630	21	0.2 - 2.5	60	10	N.A.
CX4	630	28	0.2 - 4	60	10	N.A.
CX4/3	630	28	0.2 - 4	60	10	N.A.
CX4/4	630	28	0.2 - 4	60	10	N.A.
CX6	630	36	0.2 - 6	60	14	N.A.
CX6/3	630	36	0.2 - 6	60	14	N.A.
CX10	630	51	0.2 - 10	60	18	N.A.
CX10/3	630	51	0.2 - 10	60	18	N.A.
CXDL2.5	630	21	0.2 - 2.5	60	10	N.A.
CXDL2.5(I.S.)	630	21	0.2 - 2.5	60	10	N.A.
CXS2.5	630	21	0.2 - 2.5	60	9	N.A.
CM1.5S	320	15	0.2 - 1.5	60	8	N.A.
CM1.5S2	320	15	0.2 - 1.5	60	8	N.A.
CM2.5S	320	21	0.2 - 2.5	60	9	N.A.
CM2.5S2	320	21	0.2 - 2.5	60	9	N.A.
CMS2.5	400	21	0.2 - 2.5	60	9	N.A.
CXG2.5	630	N.A.	0.2 - 2.5	60	10	N.A.
CXG2.5/3	630	N.A.	0.2 - 2.5	60	10	N.A.
CXG2.5/4	630	N.A.	0.2 - 2.5	60	10	N.A.
CXG4	630	N.A.	0.2 - 4	60	10	N.A.
CXG4/3	630	N.A.	0.2 - 4	60	10	N.A.
CXG4/4	630	N.A.	0.2 - 4	60	10	N.A.
CXG6	630	N.A.	0.2 - 6	60	14	N.A.
CXG6/3	630	N.A.	0.2 - 6	60	14	N.A.
CXG10	630	N.A.	0.2 - 10	60	18	N.A.
CXG10/3	630	N.A.	0.2 - 10	60	18	N.A.
CXDLG2.5	630	21 A TOP CB	0.2 - 2.5	60	10	N.A.
CXDLG2.5(I.S.)	630	N.A.	0.2 - 2.5	60	10	N.A.
CXSG2.5	630	N.A.	0.2 - 2.5	60	9	N.A.
CMCG4	630	N.A.	0.2 - 4	60	9	0.5
CDLG4	400	28 A TOP CB	0.2 - 4	60	8	0.5
CSB3/N3UL	500	36	0.5 - 6	60	9	0.5
CSB3/N3U	500	36	0.5 - 6	60	9	0.5
CBS3U	500	36	0.5 - 6	60	9	0.5
CSB4/N4U	500	51	1.5 - 10	60	9	1.2
CBS4U	500	51	1.5 - 10	60	9	1.2
CSB5/N5U	630	68	1.5 - 16	60	9	2
CBS5U	630	68	1.5 - 16	60	9	2
STH3	630	36	1.5 - 6	60	8	0.5
STH4	500	36	1.5 - 6	60	10	1.2
STH6	630	110	1.5 - 35	60	12	2.5

ATEX-IECE_x APPROVED TERMINAL BLOCKS

Marking :

For increased safety 'e'

Sira 16ATEX3029U

Ⓔ II 3G Ex ec IIC Gc

For intrinsic safety 'i'

Sira 16ATEX3029U

Ⓔ II 3G Ex ic IIC Gc

Ambient Temperature range : -40°C to +40°C

Service Temperature range : -40°C to +85°C

IECE_x SIR 16.0015U

Ex ec IIC Gc

IECE_x SIR 16.0015U

Ex ic IIC Gc

Insulation Material: Polyamide 66, CTI 600 / Material Group I.

Terminal Block	Increased Safety 'e' Voltage (V)	Current (A)	Wire Size (sq.mm)	Intrinsic Safety 'i' Voltage (V)	Stripping Length (mm)	Torque (Nm)
CXF4	630	6.3	0.2 - 4	60	10	N.A.
CXF4L	630	6.3	0.2 - 4	60	10	N.A.
CXCC4-CPFL	630	6.3	0.2 - 4	60	10	N.A.
CXCC4-CPF	630	6.3	0.2 - 4	60	10	N.A.
CF4U	500	6.3	0.2 - 4	60	8	0.5
CF4UL	500	6.3	0.2 - 4	60	8	0.5
DDFL4U	500	6.3	0.2 - 4	60	8	0.5
DDFL4UE	500	6.3	0.2 - 4	60	8	0.5
CKT4U	630	24	0.2 - 4	60	8	0.5
CKT4U/4	630	24	0.2 - 4	60	8	0.5
CXK2.5	630	17	0.2 - 2.5	60	10	N.A.
CXK2.5/4	630	17	0.2 - 2.5	60	10	N.A.

Marking :

For increased safety 'e'

Sira 16ATEX3170U

0518 Ⓔ II 2G Ex eb IIC Gb

For intrinsic safety 'i'

Sira 16ATEX3170U

0518 Ⓔ II 2G Ex ib IIC Gb

Ambient Temperature range : -40°C to +40°C

Service Temperature range : -40°C to +85°C

IECE_x SIR 16.0056U

Ex eb IIC Gb

IECE_x SIR 16.0056U

Ex ib IIC Gb

Insulation Material: Polyamide 66, CTI 600 / Material Group I.

Terminal Block	Increased Safety	Current	Wire Size	Intrinsic Safety	Stripping Length	Torque
CTS2.5UN	690	21	0.5-2.5	60	9	0.4
CTS2.5UE	690	28	0.5-4	60	9	0.5
CTS4UN	690	28	0.5-4	60	9	0.5
CTS6U	690	36	1.5-6	60	12	0.8
CTS10U	690	50	1.5-10	60	12	1.2
CTS16U	690	66	2.5-16	60	12	2
CTS25U	690	88	6 - 25	60	14	2
CTS25UN	690	88	6 - 25	60	14	2
CTS35UN	800	109	10 - 35	60	16	2.5
CMT4	350	28	0.5-4	60	8	0.5
CMB4	250	28	0.5-4	60	8	0.5
CMC1-2	690	28	0.5-4	60	9	0.5
CMC2-2	690	28	0.5-4	60	9	0.5
CDL4UN	440	28	0.5-4	60	8	0.5
CDL4U	350	28	0.5-4	60	8	0.5
ODL4U	550	28	0.5-4	60	9	0.5
CTL2.5U	440	21	0.5-2.5	60	8	0.4
CTL2.5UH	440	21	0.5-2.5	60	8	0.4
CSCP2.5T	440	21	0.5-2.5	60	11	NA
CSCP2.5T2	440	21	0.5-2.5	60	11	NA
CGMT4	350	NA	0.5-4	60	9	0.5
CGT4U	500	NA	0.5-4	60	9	0.5
CGT10U	630	NA	1.5-10	60	12	1.2
CGT35U	630	NA	10 - 35	60	18	2.5
CGT4N	440	NA	0.5-4	60	9	0.5
CGT6N	630	NA	0.5-6	60	12	0.8

ATEX-IECE_x APPROVED TERMINAL BLOCKS

Terminal Block	Increased Safety 'e' Voltage (V)	Current (A)	Wire Size (sq.mm)	Intrinsic Safety 'i' Voltage (V)	Stripping Length (mm)	Torque (Nm)
CGT10N	630	NA	1.5-10	60	12	1.2
CGT16N	630	NA	2.5-16	60	14	2
PTB35/50SH / PTB35/50	1100	126	16 - 50	60	18	3
AS2.5	630	21	0.34-2.5	60	11	NA
AS2.5/3	630	21	0.34-2.5	60	11	NA
AS2.5/4	630	21	0.34-2.5	60	11	NA
AS4	630	28	0.34-4	60	12	NA
AS4/3	630	28	0.34-4	60	12	NA
AS4/4	630	28	0.34-4	60	12	NA
AS6	630	36	0.34-6	60	13	NA
AS6/3	630	36	0.34-6	60	13	NA
AGT2.5	630	NA	0.34-2.5	60	11	NA
AGT2.5/3	630	NA	0.34-2.5	60	11	NA
AGT2.5/4	630	NA	0.34-2.5	60	11	NA
AGT4	630	NA	0.34-4	60	12	NA
AGT4/3	630	NA	0.34-4	60	12	NA
AGT4/4	630	NA	0.34-4	60	12	NA
AGT6	630	NA	0.34-6	60	13	NA
AGT6/3	630	NA	0.34-6	60	13	NA

WIRE TERMINATION

Systematic wiring in a panel board requires a layout of properly selected Terminal Blocks. In the normal course, it would be appropriate to assign one wire per clamping unit of a Terminal Block thus, simplifying the task of identification of the circuit.

The Screw Clamp Terminal Blocks can accommodate wires one size higher than the rated cross section. It must be noted that they can also take two wires one size smaller than the rated cross section.

If, however, two wires are connected to one clamping unit of a screw clamp Terminal Block, care must be taken to ensure that the total current assigned to the two wires does not exceed the continuous rating of the Terminal Block.

For 'Screwless' Spring Clamp Terminal Blocks, special care must be taken that only one wire must be connected per clamping unit.

The relevant standard, IEC 60947-7-1, section 4.3.5 states that for Terminal Blocks with a rated cross section from 0.2 sq. mm to 35 sq. mm. (both inclusive), the manufacturer shall specify the range and number of the rated cross section. The conductor can be rigid (solid or multi strands) or flexible (fine strands), these values can be found in product related technical data.

Connectwell feed through Terminal Blocks are designed to allow copper wires to be connected without any special preparations such as soldering the individual strands of wire or using cable lugs / ferrules. However, wires requiring special preparation can also be used in Connectwell Terminal Blocks, as per IEC 60947-7-1.

For connecting aluminium wires, special care must be taken while stripping the insulation from the wires. It is strictly recommended to use ferrules and lugs while connecting flexible aluminium wires. Once the wire has been stripped of its insulation to the recommended length, it should be coated with acid and alkaline free Vaseline and screwed into the terminal immediately. This procedure must be followed each time that an aluminium wire is to be disconnected and reconnected.

In applications where connections have to be changed frequently, it is recommended to use lugs/ferrules/cable sockets to avoid fracturing of individual wires.

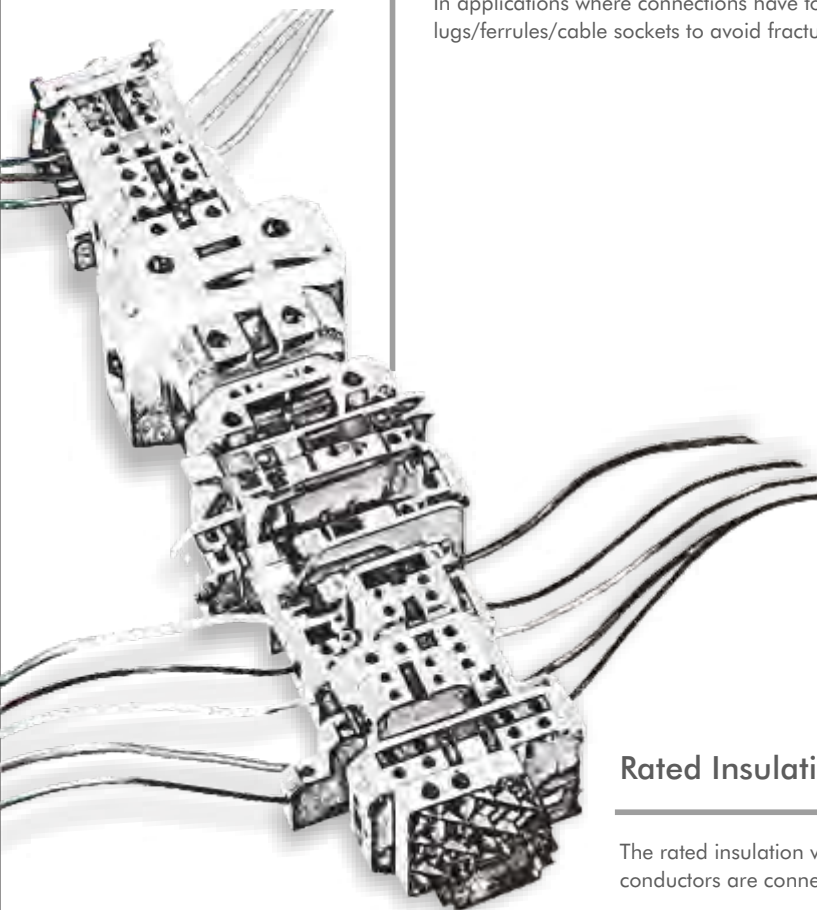

Rated Insulation Voltage with two wires/conductors

The rated insulation voltage of the Terminal Blocks does not change if the wires / conductors are connected correctly.

WIRE CONNECTION METHOD

Screw Clamp Connection

'The Screw Clamp Connection' is the most popular method of wire termination. It offers distinct advantages over the other wire termination methods:

- Suitable for all cross-sections and types of wires
- Wires can be connected without any special preparation
- Provides vibration resistant connection
- Simple connection and disconnection of wires with the aid of an ordinary screw driver (Fig.1)
- The cold forged rolled threaded screws provide high tightening torque.

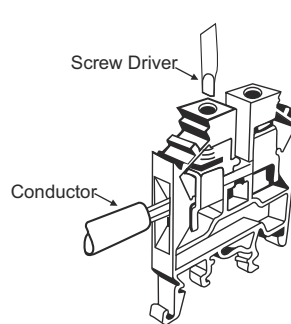

Fig. 1
Screw Clamp Operation

The steel clamping screw produces high contact force while the steel clamping yoke transmits this force by pressing the conductor against the current bar. The conducting medium within a Terminal Block is its current bar, which is made from electrolytic copper or 63 / 37 brass and tin plated. The tin plating on the current bar ensures excellent continuous contact and provides good protection against corrosion. Even the best electrical conductor materials are worthless without the required contact force to press the connected wire to the contact surface on the current bar. It is because of this that the clamping yokes and screws are made of steel. The steel parts are zinc plated and additionally chromate passivated in order to achieve the highest degree of corrosion resistance.

When the clamping screw is tightened, the clamping yoke gets pulled upwards, pressing the wire against the current bar. The clamping yoke and current bar are serrated. The serrations of the current bar cut through the oxide skin of the wire on tightening, thereby providing many contact lines. The serrations of the clamping yoke improve the gripping of the wire. When the wire is tightened, the clamping pressure pulls the top threaded surfaces of the yoke exerting extra high locking action on the clamping screw. (Fig. 2)

Changes caused by temperature variations, if any, are effectively equalised by the elasticity of steel, providing excellent vibration resistance.

Large pressure areas on the current bar and the clamping yoke prevent notching, which otherwise could lead to possible wire fracture. The clamping yokes come in different sizes and shapes to accommodate wires of different cross sections. A flat clamping area ensures safe gripping of wires of smaller cross sections. The flange / tail of the clamping yokes prevents false entry of the wires underneath the yokes.

The following characteristics make the Screw Clamp Connection user friendly, versatile and sturdy:

- Strong contact force which makes it absolutely gas tight
- Very low contact resistance
- Excellent vibration proof protection preventing loosening of screws
- Reliable electrical and mechanical connection
- Ease of handling

Cable Lug Connection

This method of wire termination is preferred for connections that are subject to very severe vibrations. The wire is crimped to a ring/fork type and is screwed on to the flat current bar in the Terminal Block.

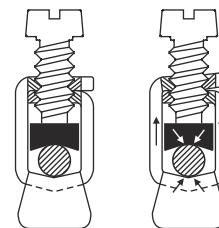
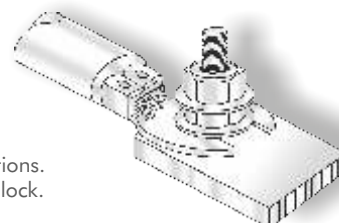
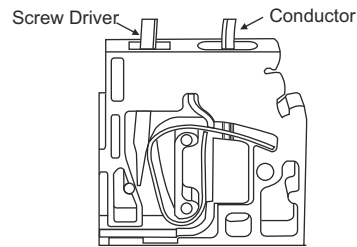
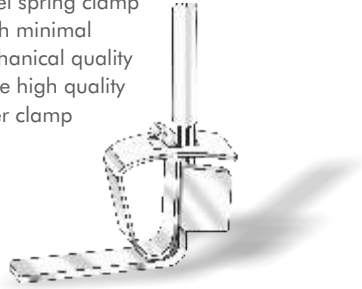

Fig. 2
Wire / Conductor Retention

Spring Clamp Technology

The more recently introduced Screwless Spring Clamp connection is as versatile as the screw clamp connection. In this type of a connection, the wire is held against the electrolytic copper current bar directly by a pre stressed spring clamp. The spring is operated by using a screw driver to provide an access to the wire through the opening in the spring clamp. The inserted wire gets clamped on to the current bar on the removal of the screw driver. The high quality stainless steel spring clamp ensures a good connection of the wire with minimal contact resistance. The electrical and mechanical quality of the wire connection is maintained by the high quality rust proof spring clamp. Only one wire per clamp must be terminated.



Screwless Spring Clamp Actuation

The following are the characteristics of Spring Clamp Connection:

- Easy to operate, versatile and vibration proof
- Minimal contact resistance because of a gas tight connection is made possible by the high quality stainless steel spring clamp
- Fail proof / safe, maintenance free connection
- The surface treated (tin plated) electrolytic copper current bar ensures oxidation free contact

Push-In Technology

Push-In Terminal Blocks have a specialized connection system that enables tool-less wire connection. Reliable, vibration resistant, gas-tight connections are made with an inbuilt high-quality stainless steel Push-In spring clamps. Lugged cable & solid wires can be directly pressed into the clamp to make connections.

The Push button on the top is pressed for using a flexible cable without lug/ferrule for connection. These Terminal Blocks can be cross connected by using pluggable jumpers available in various pole configurations.

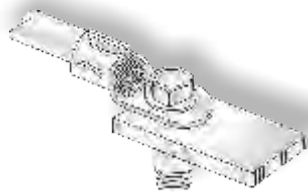
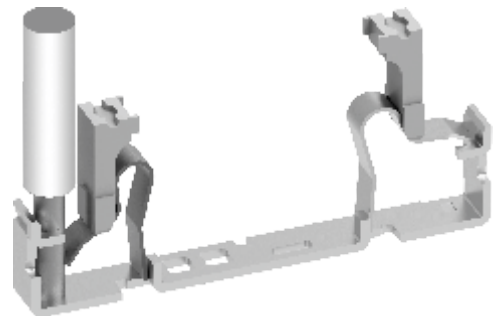

Cable Lug / Bus Bar Connection

This type of connection is preferred for wires of larger cross sections. The conductor is fit with a lug and bolted on to the flat current bar. This method is also ideal for connections subject to very severe vibrations.

Tab Connection

Tab connections are preferred in applications where the connected wire needs to be frequently connected and disconnected. A tab sleeve with a crimped wire is pushed on to the Terminal Block.



Solder Connection

Solder connections are suitable for wires having a cross section up to 2.5 sq. mm. In this type of connection, the wire is soldered to a solder lug. If done professionally, soldering can provide a good electrical connection.

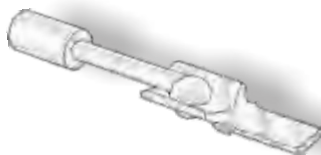

Wire Wrap Connection

This type of connection is suitable for connecting a thin solid wire. The wire is wrapped to a square pin provided in the Terminal Block. A special tool is required for wrapping the wire to the square pin.



WIRE TIGHTENING

The design of the Connectwell Screw Clamps / Cable Lug system ensures vibration proof positive connection wires at the recommended torque values. However, Connectwell Terminal Blocks can withstand torque levels in excess of the recommended torque values. The Terminal Block clamping parts when tightened within the torque range ensure optimum performance as given below:

- The voltage drop (contact resistance) is well below the specified limits
- The wire gets clamped perfectly to form a gas tight connection
- The clamping yoke does not get damaged mechanically. The tightening torque according to IEC 60947-7-1 table 4, is the safe limit of the torque which guarantees the successful clamping of the connected wire.

Connectwell Terminal Blocks tightening torque data is given in the respective product pages.

All Connectwell Terminal Blocks are designed to function with rated wire sizes as per their respective AWG (American Wire Gauge) or Metric size/system. The Terminal Blocks are tested for Gauge Insertion as per VDE 0660.

Tightening Torque for Screw Clamp Terminal Blocks

Terminal Blocks	Thread Size of Fastener	Recommended Torque Value
CTS2.5UN/CPT(M)/CPT5	M 2.5	0.4 Nm
CTS2.5(M)/CMST1/CMST2	M 2.6	0.4 Nm
CTS2.5/CMT4/CMB4/CDL4U/ODL4U/ CGT4U/CTS4UN/CTS4SC/CSTSB3/CSFL4U/ CSDL4U/CKT4U/CPT7.5/DDFL4U/ DDFL4U(E)/DDFL4U(E)LR/CMC1-2/CMC2-2	M 3	0.5 Nm
CTS6/CTS6SC/CTS6U/CSFL6U/CENC4	M 3.5	0.8 Nm
CTS10/10U/CTS16/16U/CSTSN4/B4/CDTTS/ CTS10SC/CGT10U/DDPT/CDTTU/CSTSN4U/STH4	M 4	1.2 Nm
CTS25U/CSTSB5/N5/N5(15)/RN5/N5U/CENC16	M 5	2.0 Nm
CTS35/CTS35U/CENC35/CGT35U/CSTSN6U	M 6.0	2.0 Nm
CTS35L/35LS/CSTSRN6/CSTSN6	M 6.0	2.8 Nm
CTS70L/70LS	M8.0	6.0 Nm
CTS95L/95LS	M10.0	10.0 Nm

Conductor cross-sections and Gauges

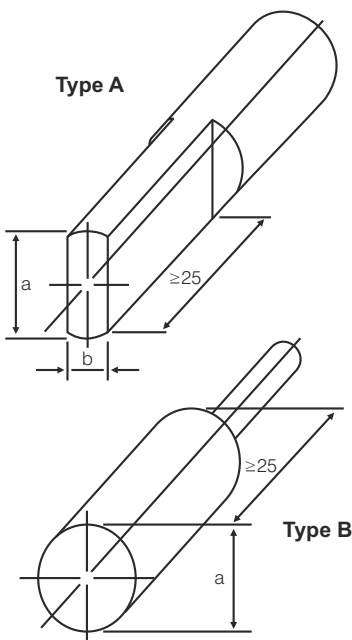

Representative Picture of Gauge Type A and Type B

Conductor Cross-section							
Flexible (sq.mm)	Rigid (solid or stranded) (sq.mm)	Gauge Type A			Gauge Type B		Permissible deviation for a and b
		Marking	Diameter a (mm)	Width b (mm)	Marking	Diameter a (mm)	
1.5	1.5	A1	2.4	1.5	B1	1.9	0 / -0.05
2.5	2.5	A2	2.8	2.0	B2	2.4	0 / -0.05
2.5	4	A3	2.8	2.4	B3	2.7	0 / -0.05
4	6	A4	3.6	3.1	B4	3.5	0 / -0.06
6	10	A5	4.3	4.0	B5	4.4	0 / -0.06
10	16	A6	5.4	5.1	B6	5.3	0 / -0.06
16	25	A7	7.1	6.3	B7	6.9	0 / -0.07
25	35	A8	8.3	7.8	B8	8.2	0 / -0.07
35	50	A9	10.2	9.2	B9	10.0	0 / -0.07
50	70	A10	12.3	11.0	B10	12.0	0 / -0.08
70	95	A11	14.2	13.1	B11	14.0	0 / -0.08
95	120	A12	16.2	15.1	B12	16.0	0 / -0.08
120	150	A13	18.2	17.0	B13	18.0	0 / -0.08
150	185	A14	20.2	19.0	B14	20.0	0 / -0.08
185	240	A15	22.2	21.0	B15	22.0	0 / -0.09
240	300	A16	26.5	24.0	B16	26.0	0 / -0.09

ELECTRICAL DATA

Connectwell Terminal Blocks are standard blocks for industries such as Switchgear, Distribution, Machine Tools Control, Instrumentation Installations, Material Handling Equipments, Process Plants On and Offshore Installations and Panel Board Construction.

Rated Voltage

The voltage rating of the product is assigned in accordance with specifications related to Creepage & Clearance distance defined in respective EN, VDE, UL and CSA standards, for the environmental conditions and pollution degrees as given below.

Degree of Pollution

Pollution degree 1	No pollution or only dry, non-conductive pollution occurs. The pollution has no influence.
Pollution degree 2	Only non-conductive pollution occurs except that occasionally a temporary conductivity caused by condensation is to be expected.
Pollution degree 3	Conductive pollution occurs or dry, non conductive pollution occurs which becomes conductive due to condensation is to be expected.
Pollution degree 4	The pollution generates persistent conductivity caused by conductive dust or by rain or snow.

Rated Impulse Voltage

The rated impulse voltage of the product is the peak value of an impulse voltage with which the terminal block can be loaded and on which the creepage and clearances according to relevant standard are based.

CTI - Comparative Tracking Index of Insulation material

The insulation material is divided into four groups according to their CTI (Comparative Tracking Index)

Material Group I	600 ≤ CTI
Material Group II	400 ≤ CTI < 600
Material Group III a	175 ≤ CTI < 400
Material Group III b	100 ≤ CTI < 175

The Comparative Tracking Index must be defined according to DIN IEC 112/ VDE 0303 part 1 on specimens made specifically for this purpose with test solution A. The proof-tracking index (PTI) is also used to identify the tracking characteristics of materials. A material may be included in one of the four groups given above on the basis that its PTI, established by the method of IEC 112 using solution A, is equal to or greater than the lower value specified for the Insulation group.

Current carrying capacity of terminal block

(DIN EN 60947-7-1/VDE 0611part1: 2000-05)

The data given below is for unprepared conductor ends without ferrules. The rated current for Terminal Blocks with specific functions such as Fuse type, Relays, Terminal Blocks incorporating electronic components is to be specified by manufacturer.

Rated Cross Section (sq.mm)	0.2	0.5	0.75	1	1.5	2.5	4	6	10	16	25	35	50	70	95	120	150	185	240	300
Test current (A)	4	6	9	13.5	17.5	24	32	41	57	76	101	125	150	192	232	269	309	353	415	520

Current Rating with two wire/conductors

The total current of the two wires / conductors should not exceed the continuous current rating of the Terminal Block. The continuous current rating is the maximum current the terminal block can conduct without a temperature rise of 45 K (as per EN standard) and 30°C (as per UL / CSA standard).

Note

For PE-Terminals only one conductor should be connected per clamping part, in accordance with installation requirement.

TERMINAL BLOCK MATERIAL

Connectwell Terminal Blocks are made of carefully selected materials, insulating materials, clamping and conducting metals which are subject to strict quality control as demanded by the most stringent international standards.

Clamping Screws

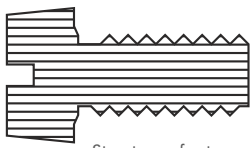

Structure of a turned Screw

One of the most important parts of the terminal block is its screw. The quality of the connection depends mainly on the quality of the screw. The screw must not get damaged, should withstand a higher torque than what is stipulated in its specification. The screw should not, even at the highest stress weld with the metal of the main thread.

Connectwell Terminal Blocks employ cold forged rolled threaded steel screws. In such screws the material is compressed and therefore strengthened. Whereas, when turned screws are cut, the material from between the threads is removed. Because of this and the stress concentration on the neck of the screw, the turned screw is considerably weaker on strength.

The screws are zinc plated and chromate passivated for a good galvanic surface.

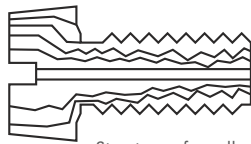

Structure of a rolled Screw

Clamping yoke

Clamping yokes in carefully selected grades of steel ensure high torque performance necessary for gas tight connections. The clamping components (both screws and clamping yokes) are electroplated with zinc and passivated by an additional coat of chromate. The Zinc provides a cathodic protection to the steel. Therefore the effect of protection against corrosion is still retained even when the plating is partially damaged by scratches or pores.

The clamping components of some of Connectwells Terminal Blocks are made of copper alloys. Such components are electroplated with either nickel or tin to ensure oxidation free performance.

Current carrying / Conducting components

The current carrying/conducting components / current bars are made of electrolytic grade copper or copper alloy to ensure very low contact resistance. The components are electroplated with tin / nickel to provide an oxidation free contact.

Insulating Material

All the live parts in Terminal Blocks are totally shrouded to minimize the risk of accidental contact in High Grade Melamine or in Engineering Thermoplastic Polyamide 6.6 Housing.

High Grade Melamine

Melamine is a thermosetting material of the amino group pf plastics. Apart from its inherent dielectric properties, it retains its mechanical, electrical and dimensional stability under conditions of heat, cold, damp and dryness to a degree in excess of commercial thermoplastic and phenolic material. It has very good insulation properties and a high resistance to flash over. Since its material is of eroding type rather than carbonising type, its resistance to tracking is also high. The moulded housing is non-hygroscopic, not subject to mould growth, is completely reliable in tropical conditions and can be used in a temperature range of - 55°C to + 130°C.

TERMINAL BLOCK MATERIAL

Polyamide 6.6

Engineering Thermoplastic Polyamide 6.6 has excellent electrical, mechanical and chemical characteristics, even at temperature as high as 105°C. This insulating material has high mechanical strength - it is unbreakable. Its resistance to tracking is similar to Melamine. The Polyamide 6.6 moulded housing absorbs humidity from its surroundings. However, it does not crystallise water in the plastic itself as is the case in thermosetting plastic. The H₂O groups combine within the molecular structure.

Thus moulded plastic housing becomes fracture proof and unbreakable even in sub zero temperature conditions.

Polyamide 6.6 is difficult to ignite, self-extinguishing, burns only as long as there is a supporting flame and is rated V2 according to UL 94. It has excellent resistance to micro organisms, bacteria, enzymes and termites. Good ageing resistance and insensitivity to ultra violet light makes it suitable for tropical and open air applications. Polyamide 6.6 has excellent resistance to fuels, oils, fats and most common solvents like aliphatic and aromatic carbohydrates, ketons and alcohols.

Typical properties of insulation material

Property	Unit	Thermoset High Grade Melamine	Engineering Thermoplastic Polyamide 6.6
Specific Gravity	-	1.5	1.2 - 1.15
Upper Temperature Limit	°C	130	105
Lower Temperature Limit	°C	- 55	- 50
Volume Resistivity	Ohm cm	10 ¹¹	10 ¹²
Surface Resistivity	Ohm	10 ¹⁰	10 ¹⁰
Dielectric Strength	KV/cm	100	400
Tropical Resistance	-	Good	Good
Flammability	Grade	V0	V2 / V0 #
Flexibility	-	-	Excellent

V0 available on request

CE Marking

The CE marking is, in particular, an indication that the products comply with the essential requirements of applicable directives and that the products have been subject to a conformity assessment procedure provided for in the directives. CE marking ensures free trading within Europe. Connectwell terminal blocks are CE marked and the products comply to Low Voltage Directive, 73/23/EEC, Including amendments by the CE marking directive, 93/68/EEC

At Connectwell the Product Development cycle, production & assembly of components and supply are all controlled by an ISO 9001:2015 Quality Management System.

Connectwell Products not only fulfill Customers needs and requirements of standards and specifications but also surpass the same.

TECHNICAL INFORMATION









FUSE TERMINAL BLOCKS

Max. power dissipation with Reference IEC 60947-7-3

When selecting Cartridge fuse inserts, please ensure that the maximum power dissipation specified below is not exceeded. Details can be obtained from the fuse manufacturers.

Cartridge fuse inserts 5 X 20 mm

Terminal Block	Rated Voltage (V)	Rated Current (I _{max})	Exclusive short circuit protection	
			Separate Arrangement	Compound Arrangement
CXF4	1000	10	2W	2W
CXF4L	1000	10	2W	2W
CXCC4-CPF	1000	10	2W	2W
CXCC4-CPFL	1000	10	2W	2W
CYDLGF4LRL	500	10	2W	2W
CYDLGF4LRL	500	10	2W	2W
CYDLGF4LRL	500	10	2W	2W
CYDLF4LR	500	10	2W	2W
CYDLGF4L	500	10	2W	2W
CYDLF4L	500	10	2W	2W
CYDLGF4	500	10	2W	2W
CYDLF4	500	10	2W	2W
CXF4/3	1000	10	2W	2W
CXF4/3L	1000	10	2W	2W
CXAF4/3	1000	10	2W	2W
CXCC4/3-CPF	1000	10	2W	2W
CXCC4/3-CPFL	1000	10	2W	2W
CXVFA	800	10	2W	2W
CXVF2.5A	800	10	2W	2W

Index	Cat. No.	Pg. No.	Cat. No.	Pg. No.	Cat. No.	Pg. No.
The Index gives ready reference of Cat. No. / Type and cross reference of page number.	ADLG2.5	109	CA402	218	CA509/K9/H	222
Abbreviation used:	AGT2.5	133	CA501-1M	217	CA509/K9/V	222
Colour	AGT2.5/3	134	CA501-1M-S	217	CA509/K9F/H	222
Ordering Suffix	AGT2.5/4	135	CA501-2M	217	CA509/K9F/V	222
Blue 	AGT4	134	CA501-2M-S	217	CA509/K9FWHT	222
Black 	AGT4/3	135	CA502	218	CA509/K9WHT	222
Orange 	AGT4/4	136	CA502/F	211	CA510/01	232
Red 	AGT6	134	CA503/01	232	CA510/1	232
Green 	AGT6/3	136	CA503/1	232	CA510/5	232
Yellow 	AS2.5	129	CA503/5	232	CA512/10-2	232
White 	AS2.5/3	130	CA504/01	232	CA512/10-3	232
Beige 	AS2.5/3BK	130	CA504/1	232	CA512/10-4	232
	AS2.5/3BU	130	CA504/5	232	CA512/11-2	231
	AS2.5/3GN	130	CA505/01	232	CA512/1-2	231
	AS2.5/3R	130	CA505/1	232	CA512/12-2	232
	AS2.5/3Y	130	CA505/5	232	CA512/1-3	231
	AS2.5/4	131	CA506/01	232	CA512/13-2	231
	AS2.5/4BK	131	CA506/1	232	CA512/13-3	231
	AS2.5/4BU	131	CA506/5	232	CA512/13-4	231
	AS2.5/4GN	131	CA507/L/Q/01	232	CA512/1-4	231
	AS2.5/4R	131	CA507/S/Q/01	232	CA512/14-2	232
	AS2.5/4Y	131	CA508/L/Q	232	CA512/14-3	232
	AS2.5BK	129	CA508/S/Q	232	CA512/14-4	232
	AS2.5BU	129	CA509/7	211	CA512/15-2	231
	AS2.5GN	129	CA509/G1	219	CA512/15-3	231
	AS2.5R	129	CA509/G2	219	CA512/15-4	231
	AS2.5Y	129	CA509/K10/H	222	CA512/17-2	232
	AS4	130	CA509/K10/V	222	CA512/17-3	232
	AS4/3	131	CA509/K10WHT	222	CA512/17-4	232
	AS4/3BK	131	CA509/K12/H	222	CA512/2-2	231
	AS4/3BU	131	CA509/K12/V	222	CA512/2-3	231
	AS4/3GN	131	CA509/K12WHT	222	CA512/2-4	231
	AS4/3R	131	CA509/K16/H	222	CA512/3-2	232
	AS4/3Y	131	CA509/K16/V	222	CA512/3-3	232
	AS4/4	132	CA509/K16WHT	222	CA512/3-4	232
	AS4/4BK	132	CA509/K2/H	222	CA512/4-2	232
	AS4/4BU	132	CA509/K2/V	222	CA512/4-3	232
	AS4/4GN	132	CA509/K2B4/H	222	CA512/4-4	232
	AS4/4R	132	CA509/K2B4/V	222	CA512/5-2	231
	AS4/4Y	132	CA509/K2B4WHT	222	CA512/5-3	231
	AS4BK	130	CA509/K2G/H	222	CA512/5-4	231
	AS4BU	130	CA509/K2G/V	222	CA512/6-2	232
	AS4GN	130	CA509/K2GWHT	222	CA512/6-3	232
	AS4R	130	CA509/K2WHT	222	CA512/6-4	232
	AS4Y	130	CA509/K3.5WHT	222	CA512/7-2	231
	AS6	130	CA509/K3/H	222	CA512/7-3	231
	AS6/3	132	CA509/K3/V	222	CA512/7-4	231
	AS6/3BK	132	CA509/K3WHT	222	CA512/8-2	232
	AS6/3BU	132	CA509/K4/H	222	CA512/8-3	232
	AS6/3GN	132	CA509/K4/V	222	CA512/8-4	232
	AS6/3R	132	CA509/K4WHT	222	CA512/9-2	231
	AS6/3Y	132	CA509/K5/H	222	CA512/9-3	231
	AS6BK	130	CA509/K5/V	222	CA512/9-4	231
	AS6BU	130	CA509/K5WHT	222	CA513	211
	AS6GN	130	CA509/K6/H	222	CA514/10-2	232
	AS6R	130	CA509/K6/V	222	CA514/10-3	232
	AS6Y	130	CA509/K6F/H	222	CA514/10-4	232
	ATL2.5	110	CA509/K6F/V	222	CA514/11-2	231
	ATL2.5H	110	CA509/K6FWHT	222	CA514/1-2	231
	ATLG2.5	110	CA509/K6WHT	222	CA514/12-2	232
	AUX6	14	CA509/K7.5/H	222	CA514/1-3	231
	CA102	218	CA509/K7.5/V	222	CA514/13-2	231
	CA103	218	CA509/K7.5WHT	222	CA514/13-3	231
	CA104	218	CA509/K8/H	222	CA514/13-4	231
	CA202	218	CA509/K8/V	222	CA514/1-4	231
	CA302	218	CA509/K8WHT	222	CA514/14-2	232

When ordering please add colour suffix to Cat. No.

Example: CTS2.5UNR

Note:

Colours given above are indicative purpose only.

Contact us for colour products that are not listed in Alphabetical index.

Cat. No.	Pg. No.	Cat. No.	Pg. No.	Cat. No.	Pg. No.	Cat. No.	Pg. No.
CA514/14-3	232	CA625/4	229	CA707/S/Q/1	228	CA729/2	227
CA514/14-3A	232	CA627/10	229	CA707/S/Q/2	228	CA729/3	227
CA514/14-4	232	CA627/2	229	CA707/S/Q/3	228	CA729/4	227
CA514/14-4A	232	CA627/3	229	CA710/10	228	CA731/10	228
CA514/15-2	231	CA627/4	229	CA710/2	228	CA731/100	228
CA514/15-3	231	CA628/2	229	CA710/3	228	CA731/10-A	228
CA514/15-4	231	CA628/3	229	CA710/4	228	CA732/10	228
CA514/17-2	232	CA629/2	229	CA711/10	228	CA732/100	228
CA514/17-3	232	CA629/3	229	CA711/2	228	CA732/10-A	228
CA514/17-4	232	CA643/10	229	CA711/3	228	CA733/10	228
CA514/2-2	231	CA643/2	229	CA711/4	228	CA734/10	228
CA514/2-3	231	CA643/3	229	CA713/10	228	CA735/10	228
CA514/2-4	231	CA643/4	229	CA713/2	228	CA737/10	228
CA514/3-2	232	CA644/10	229	CA713/3	228	CA739/10	228
CA514/3-3	232	CA644/2	229	CA713/4	228	CA741/10	227
CA514/3-4	232	CA644/3	229	CA714/10	228	CA741/100	227
CA514/4-2	232	CA644/4	229	CA714/2	228	CA741/2	227
CA514/4-3	232	CA645/10	229	CA714/3	228	CA741/3	227
CA514/4-4	232	CA645/2	229	CA714/4	228	CA741/4	227
CA514/5-2	231	CA645/3	229	CA715/10	228	CA742/10	227
CA514/5-3	231	CA645/4	229	CA715/2	228	CA742/100	227
CA514/5-4	231	CA701-15-1M	217	CA715/3	228	CA742/2	227
CA514/6-2	232	CA701-15-1M-S	217	CA715/4	228	CA742/3	227
CA514/6-3	232	CA701-15-2M	217	CA716/10	228	CA742/4	227
CA514/6-4	232	CA701-15-2M-S	217	CA716/2	228	CA743/10	227
CA514/7-2	231	CA701-1M	217	CA716/3	228	CA743/2	227
CA514/7-3	231	CA701-1M-S	217	CA716/4	228	CA743/3	227
CA514/7-4	231	CA701-2M	217	CA717/10	228	CA743/4	227
CA514/8-2	232	CA701-2M-S	217	CA717/2	228	CA744/10	227
CA514/8-3	232	CA702	218	CA717/3	228	CA744/2	227
CA514/8-4	232	CA703	220	CA717/4	228	CA744/3	227
CA514/9-2	231	CA703/01	228	CA718/10	228	CA744/4	227
CA514/9-3	231	CA703/1	228	CA718/2	228	CA745/10	227
CA514/9-4	231	CA703/10	228	CA718/3	228	CA745/2	227
CA521/10	231	CA703/11	229	CA718/4	228	CA745/3	227
CA521/2	231	CA703/2	228	CA721/10	227	CA745/4	227
CA521/3	231	CA703/3	228	CA721/100	227	CA747/10	227
CA521/4	231	CA703/4	228	CA721/2	227	CA747/2	227
CA522/10	231	CA703/6	228	CA721/3	227	CA747/3	227
CA522/2	231	CA703/8	228	CA721/4	227	CA747/4	227
CA522/3	231	CA703/9	229	CA722/10	227	CA749/10	227
CA522/4	231	CA704/01	228	CA722/100	227	CA749/2	227
CA601-1M	217	CA704/1	228	CA722/2	227	CA749/3	227
CA602	218	CA704/10	228	CA722/3	227	CA749/4	227
CA603	220	CA704/11	229	CA722/4	227	CA751/10	227
CA607/S/Q	228	CA704/2	228	CA723/10	227	CA751/2	227
CA611/S/Q	230	CA704/3	228	CA723/2	227	CA751/3	227
CA621/10	231	CA704/4	228	CA723/3	227	CA751/4	227
CA621/2	231	CA704/6	228	CA723/4	227	CA761/10	227
CA621/3	231	CA704/8	228	CA724/10	227	CA761/2	227
CA621/4	231	CA704/9	229	CA724/2	227	CA761/3	227
CA622/10	231	CA705/01	228	CA724/3	227	CA761/4	227
CA622/2	231	CA705/1	228	CA724/4	227	CA770/10	228
CA622/3	231	CA705/10	228	CA725/10	227	CA771/10	227
CA622/4	231	CA705/11	229	CA725/2	227	CA771/2	227
CA623/10	229	CA705/2	228	CA725/3	227	CA771/3	227
CA623/2	229	CA705/3	228	CA725/4	227	CA771/4	227
CA623/3	229	CA705/4	228	CA727/10	227	CA772/10	229
CA623/4	229	CA705/6	228	CA727/2	227	CA772/2	229
CA624/10	229	CA705/8	228	CA727/3	227	CA772/3	229
CA624/2	229	CA705/9	229	CA727/4	227	CA772/4	229
CA624/3	229	CA706/2	232	CA728/10	229	CA773/10	229
CA624/4	229	CA706/3	232	CA728/2	229	CA773/2	229
CA625/10	229	CA706/8	232	CA728/3	229	CA773/3	229
CA625/2	229	CA707/L/Q/1	232	CA728/4	229	CA773/4	229
CA625/3	229	CA707/S/Q/01	228	CA729/10	227	CA774/2	229

Cat. No.	Pg. No.	Cat. No.	Pg. No.	Cat. No.	Pg. No.	Cat. No.	Pg. No.
CA774/3	229	CBBPC1/70	189	CDL4UELD3	69	CF4UBK	33
CA774/4	229	CBBPC1/80	189	CDL4UELD4	69	CF4UBU	33
CA781/10	227	CBBPC2/100	191	CDL4UELD5	69	CF4UL110-240V	33
CA781/2	227	CBBPC2/160	191	CDL4UEMOV-30V	71	CF4UL6-60V	33
CA781/3	227	CBBPC2/200	191	CDL4UEMOV-60V	71	CGMT4	28
CA781/4	227	CBBPC2/250	191	CDL4UEN1	69	CGT10N	26
CA801/1	233	CBDT4U	182	CDL4UERC0.22MF	72	CGT10U	27
CA801/1-3	233	CBS3U	175	CDL4UERCO-0.1MF	72	CGT16N	27
CA801/2	233	CBS4U	176	CDL4UESDB-160V	72	CGT35U	28
CA801/2-3	233	CBS5U	176	CDL4UESDUA24V	72	CGT4N	25
CA801/3	233	CC14	31	CDL4UN	19	CGT4U	26
CA801/3-3	233	CC20	31	CDL4UN(I.S)	19	CGT50/70N	28
CA801/5	233	CC35	31	CDL4UN(I.S)BK	19	CGT6N	26
CA801/8	233	CC8	31	CDL4UN(I.S)BU	19	CHV10U	58
CA801/A10	233	CCC4U	56	CDL4UN(I.S)GN	19	CHV10UBU	58
CA801/A2	233	CCS10-20	32	CDL4UN(I.S)JO	19	CHV4U	57
CA801/A3	233	CCS15-32	32	CDL4UN(I.S)R	19	CHV4UBU	57
CA801/A4	233	CCS2X2-6	32	CDL4UN(I.S)W	19	CHV6U	58
CA802	218	CCS3-8	32	CDL4UN(I.S)Y	19	CHV6UBU	58
CA803	220	CCS4 -13.5	32	CDL4UNBK	19	CIP	56
CA803/1	233	CDB10/2	50	CDL4UNBU	19	CKT4SP	38
CA901/1	233	CDB10/3	50	CDL4UNGN	19	CKT4SPBU	38
CA901/2	233	CDB10/4	50	CDL4UNO	19	CKT4SPSC	61
CA901/3	233	CDB25/1	51	CDL4UNR	19	CKT4U	37
CA901/4	233	CDB25/2	51	CDL4UNSP	220	CKT4U/4	38
CA901/5	233	CDB25/3	51	CDL4UNW	19	CKT4U/4BU	38
CA901/6	233	CDB25/4	51	CDL4UNY	19	CKT4U/S	37
CA902	221	CDB4/1	49	CDL4USP	220	CKT4UBU	37
CA903	220	CDB4/10(1)	50	CDLG2.5	21	CKT4UD1	68
CAFL4UBK	34	CDB4/11(1)	50	CDLG4	20	CKT4UD2	68
CAFL4UBU	34	CDB4/2	49	CDLG4(I.S)	20	CKT4UH	37
CAFL4UL110V	34	CDB4/2(1)	50	CDS6U	43	CKT6U	39
CAFL4UL220V	34	CDB4/3	49	CDS6U/FT	44	CKT6UBU	39
CAFL4UL24V	34	CDB4/3(1)	50	CDS6U/SC	44	CM1.5S	137
CAFL4UL48V	34	CDB4/4	49	CDS6U/TS	44	CM1.5S2	138
CAFL4UN110V	34	CDB4/4(1)	50	CDS6UBU	43	CM1.5S2BK	138
CAFL4UN220V	34	CDB4/5	49	CDTTU	41	CM1.5S2BU	138
CAFL4UW/F	34	CDB4/5(1)	50	CDTTUBU	41	CM1.5S2GN	138
CASP	220	CDB4/6	49	CDTTUFT	42	CM1.5S2O	138
CB16/2H	214	CDB4/6(1)	50	CDTTUFTBU	42	CM1.5S2R	138
CB16/3H	214	CDB6/1	50	CDTTUFTSC	62	CM1.5S2Y	138
CB4/1	213	CDB6/2	50	CDTTUSC	62	CM1.5S2YG	138
CB4/2	213	CDB6/3	50	CDTTUSH	42	CM1.5SBK	137
CB4/2H	213	CDB6/4	50	CENC16	30	CM1.5SBU	137
CB4/3	213	CDINS16	240	CENC16BK	30	CM1.5SGN	137
CB4/3H	213	CDINS6	239	CENC16BU	30	CM1.5SO	137
CB6/1	214	CDINSD	240	CENC16G	30	CM1.5SR	137
CB6/2H	214	CDINSUK	240	CENC35	30	CM1.5SY	137
CB6/3H	214	CDINSW1	240	CENC35BK	30	CM1.5SYG	137
CB6/4H	214	CDINSW2	240	CENC35BU?	30	CM2.5S	138
CBB120	190	CDL4U(O)	69	CENC35G	30	CM2.5S2	138
CBB120LS	190	CDL4UE3LA(90V)	71	CENC4	29	CM2.5S2BK	138
CBB150	191	CDL4UED1	67	CENC4BK	29	CM2.5S2BU	138
CBB150LS	191	CDL4UED2	67	CENC4BU	29	CM2.5S2GN	138
CBB185	192	CDL4UED3	67	CENC4G	29	CM2.5S2O	138
CBB185LS	192	CDL4UED4	68	CF4SP	34	CM2.5S2R	138
CBB35/50	189	CDL4UEDD1	68	CF4SPBK	34	CM2.5S2Y	138
CBB35/50LS	189	CDL4UEDD2	68	CF4SPBU	34	CM2.5S2YG	138
CBB70	190	CDL4UEDD3	68	CF4SPD1	68	CM2.5SBK	138
CBB70LS	190	CDL4UEDD4	68	CF4SPD2	68	CM2.5SBU	138
CBB95	190	CDL4UEDD5	68	CF4SPD3	68	CM2.5SGN	138
CBB95LS	190	CDL4UEL1	69	CF4SPFT	38	CM2.5SO	138
CBBPC1/130	189	CDL4UEL2	69	CF4SPFTBU	38	CM2.5SR	138
CBBPC1/160	189	CDL4UELA90V	70	CF4SPL110-240V	34	CM2.5SY	138
CBBPC1/200	189	CDL4UELD1	69	CF4SPL6-60V	34	CM2.5SYG	138
CBBPC1/250	189	CDL4UELD2	69	CF4U	33	CM4S	139

Cat. No.	Pg. No.	Cat. No.	Pg. No.	Cat. No.	Pg. No.	Cat. No.	Pg. No.
CM4S2	139	CMST16W	211	CP3LG2.5	161	CPF	56
CM4S2BK	139	CMST17W	211	CP3LG2.5(I.S)	162	CPFL110-240V	56
CM4S2BU	139	CMST18W	211	CP4	146	CPFL6-60V	56
CM4S2GN	139	CMST19W	211	CP4/3	149	CPG1.5	151
CM4S2O	139	CMST2	212	CP4/3BK	149	CPG1.5/3	153
CM4S2R	139	CMST210W	212	CP4/3BU	149	CPG1.5/4	153
CM4S2Y	139	CMST22W	212	CP4/3GN	149	CPG2.5	152
CM4S2YG	139	CMST23W	212	CP4/3O	149	CPG2.5/3	154
CM4SBK	139	CMST24W	212	CP4/3R	149	CPG2.5/4	154
CM4SBU	139	CMST25W	212	CP4/3Y	149	CPG4	152
CM4SGN	139	CMST26W	212	CP4/4	149	CPG4/3	154
CM4SO	139	CMST27W	212	CP4/4BK	149	CPG4/4	155
CM4SR	139	CMST28W	212	CP4/4BU	149	CPG6/10	152
CM4SY	139	CMST29W	212	CP4/4GN	149	CPG6/10/3	155
CM4SYG	139	CMSTPP	235	CP4/4O	149	CPPT2.5/3	166
CMB4	64	CMT4	63	CP4/4R	149	CPPTG2.5/4	166
CMB4BK	64	CMT4BK	63	CP4/4Y	149	CPST1.5/3	165
CMB4BU	64	CMT4BU	63	CP4BK	146	CPSTG1.5/4	166
CMB4GN	64	CMT4GN	63	CP4BU	146	CSB3/N3U	176
CMB4O	64	CMT4R	63	CP4GN	146	CSB3/N3UL	177
CMB4R	64	CMT4Y	63	CP4LG2.5	162	CSB3/N3USH	177
CMB4W	64	CMTB35	221	CP4O	146	CSB4/N4U	178
CMB4Y	64	CP1.5	145	CP4R	146	CSB4/N4USH	178
CMC1-2	15	CP1.5/3	147	CP4Y	146	CSB5/N5U	178
CMC1-2BU	15	CP1.5/3BK	147	CP6/10	146	CSB5/N5USH	179
CMC2-2	16	CP1.5/3BU	147	CP6/10/3	150	CSC16/3T	101
CMC2-2BU	16	CP1.5/3GN	147	CP6/10/3BK	150	CSC16/3TBU	101
CMDB10/10	52	CP1.5/3O	147	CP6/10/3BU	150	CSC16T	97
CMDB10/2	52	CP1.5/3R	147	CP6/10/3GN	150	CSC16TBK	97
CMDB10/3	52	CP1.5/3Y	147	CP6/10/3O	150	CSC16TBU	97
CMDB10/4	52	CP1.5/4	148	CP6/10/3R	150	CSC16TGN	97
CMDB25/10	52	CP1.5/4BK	148	CP6/10/3Y	150	CSC16TR	97
CMDB25/2	52	CP1.5/4BU	148	CP6/10BK	146	CSC16TY	97
CMDB25/3	52	CP1.5/4GN	148	CP6/10BU	146	CSCG16/3T	101
CMDB25/4	52	CP1.5/4O	148	CP6/10GN	146	CSCG16T	104
CMDB4/10	51	CP1.5/4R	148	CP6/10O	146	CSCP2.5T	140
CMDB4/2	51	CP1.5/4Y	148	CP6/10R	146	CSCP2.5T2	140
CMDB4/3	51	CP1.5BK	145	CP6/10Y	146	CSCP2.5T2BK	140
CMDB4/4	51	CP1.5BU	145	CP8L32	167	CSCP2.5T2BU	140
CMDB6/10	52	CP1.5GN	145	CP8L32(I.S)	168	CSCP2.5T2GN	140
CMDB6/2	52	CP1.5O	145	CP8L32(I.S)H	168	CSCP2.5T2R	140
CMDB6/3	52	CP1.5R	145	CPD1	56	CSCP2.5T2Y	140
CMDB6/4	52	CP1.5Y	145	CPDL1.5	156	CSCP2.5TBK	140
CMDT4	205	CP2.5	146	CPDL1.5(I.S)	157	CSCP2.5TBU	140
CMDT4BK	205	CP2.5/3	148	CPDL1.5BK	156	CSCP2.5TGN	140
CMDT4BU	205	CP2.5/3BK	148	CPDL1.5BU	156	CSCP2.5TR	140
CMDT4R	205	CP2.5/3BU	148	CPDL1.5GN	156	CSCP2.5TY	140
CMDT4S	206	CP2.5/3GN	148	CPDL1.5O	156	CSDL4U	48
CMDT4SH	206	CP2.5/3O	148	CPDL1.5R	156	CSE5U	181
CMDT4SHBK	206	CP2.5/3R	148	CPDL1.5Y	156	CSP1	236
CMDT4SHBU	206	CP2.5/3Y	148	CPDL2.5	158	CSP2	236
CMDT4SHR	206	CP2.5/4	148	CPDL2.5(I.S)	158	CSTSB3	200
CMDT4SHY	206	CP2.5/4BK	148	CPDL2.5BK	158	CSTSB3BK	200
CMDT4Y	205	CP2.5/4BU	148	CPDL2.5BU	158	CSTSB3BU	200
CMS2.5	118	CP2.5/4GN	148	CPDL2.5GN	158	CSTSB3R	200
CMS2.5BK	118	CP2.5/4O	148	CPDL2.5O	158	CSTSB3Y	200
CMS2.5BU	118	CP2.5/4R	148	CPDL2.5R	158	CSTSB4/N4	201
CMS2.5GN	118	CP2.5/4Y	148	CPDL2.5Y	158	CSTSB4/N4BK	201
CMS2.5R	118	CP2.5BK	146	CPDLG1.5	157	CSTSB4/N4BU	201
CMS2.5Y	118	CP2.5BU	146	CPDLG1.5(I.S)	158	CSTSB4/N4R	201
CMST1	211	CP2.5GN	146	CPDLG2.5	159	CSTSB4/N4Y	201
CMST110W	211	CP2.5O	146	CPDLG2.5(I.S)	159	CSTSB5	201
CMST12W	211	CP2.5R	146	CPDLK2.5	163	CSTSB5BK	201
CMST13W	211	CP2.5Y	146	CPDLK2.5(I.S)	164	CSTSB5BU	201
CMST14W	211	CP3L2.5	160	CPDLKFT2.5	164	CSTSB5R	201
CMST15W	211	CP3L2.5(I.S)	161	CPDLKFT2.5(I.S)	164	CSTSB5Y	201

Cat. No.	Pg. No.	Cat. No.	Pg. No.	Cat. No.	Pg. No.	Cat. No.	Pg. No.
CSTSEP2	234	CTS10UY	11	CTS4UNBK	10	CTSP01	235
CSTSN4	202	CTS10Y	198	CTS4UNBU	10	CTSP1B	235
CSTSN415	202	CTS16	199	CTS4UNGN	10	CTSP1L	235
CSTSN415BK	202	CTS16BK	199	CTS4UNO	10	CTSP1SC	235
CSTSN415BU	202	CTS16BU	199	CTS4UNR	10	CTSP2	235
CSTSN415R	202	CTS16R	199	CTS4UNW	10	CTSP3	235
CSTSN415Y	202	CTS16U	11	CTS4UNY	10	CTT2.5UE	65
CSTSN4BK	202	CTS16UBK	11	CTS4USC	59	CTT2.5UJ	65
CSTSN4BU	202	CTS16UBU	11	CTS4USCBU	59	CTT2.5UK	65
CSTSN4R	202	CTS16UGN	11	CTS50/70N	13	CTT2.5UT	65
CSTSN4U	179	CTS16UR	11	CTS50/70NA	13	CX10	96
CSTSN4Y	202	CTS16UY	11	CTS50/70NABK	13	CX10/3	101
CSTSN5	203	CTS16Y	199	CTS50/70NABU	13	CX10/3BK	101
CSTSN515	203	CTS2.5	198	CTS50/70NAGN	13	CX10/3BU	101
CSTSN515BK	203	CTS2.5BK	198	CTS50/70NAR	13	CX10/3GN	101
CSTSN515BU	203	CTS2.5BU	198	CTS50/70NAY	13	CX10/3O	101
CSTSN515R	203	CTS2.5M	197	CTS50/70NBK	13	CX10/3R	101
CSTSN515Y	203	CTS2.5MBK	197	CTS50/70NBU	13	CX10/3Y	101
CSTSN5BK	203	CTS2.5MBU	197	CTS50/70NGN	13	CX10BK	96
CSTSN5BU	203	CTS2.5MR	197	CTS50/70NR	13	CX10BU	96
CSTSN5R	203	CTS2.5MY	197	CTS50/70NY	13	CX10GN	96
CSTSN5U	180	CTS2.5R	198	CTS6	198	CX10O	96
CSTSN5Y	203	CTS2.5UE	10	CTS6BK	198	CX10R	96
CSTSN6	204	CTS2.5UEBK	10	CTS6BU	198	CX10Y	96
CSTSN6BK	204	CTS2.5UEBU	10	CTS6R	198	CX2.5	95
CSTSN6BU	204	CTS2.5UEGN	10	CTS6SC	210	CX2.5/1B	123
CSTSN6R	204	CTS2.5UEO	10	CTS6U	10	CX2.5/2B	124
CSTSN6U	180	CTS2.5UER	10	CTS6UBK	10	CX2.5/3	98
CSTSN6USH	180	CTS2.5UEW	10	CTS6UBU	10	CX2.5/3/1B	124
CSTSN6Y	204	CTS2.5UEY	10	CTS6UGN	10	CX2.5/3BK	98
CSTSP	235	CTS2.5UN	9	CTS6UO	10	CX2.5/3BU	98
CSTSRP	234	CTS2.5UNBK	9	CTS6UR	10	CX2.5/3GN	98
CSTSRN5	204	CTS2.5UNBU	9	CTS6USC	60	CX2.5/3O	98
CSTSRN5BK	204	CTS2.5UNGN	9	CTS6USCBU	60	CX2.5/3R	98
CSTSRN5BU	204	CTS2.5UNO	9	CTS6UW	10	CX2.5/3Y	98
CSTSRN5R	204	CTS2.5UNR	9	CTS6UY	10	CX2.5/4	99
CSTSRN5Y	204	CTS2.5UNW	9	CTS6Y	198	CX2.5/4(E)D1	112
CSTSRN6	204	CTS2.5UNY	9	CTS70L	208	CX2.5/4(E)D2	112
CSTSRN6BK	204	CTS2.5Y	198	CTS70LS	208	CX2.5/4/2B	124
CSTSRN6BU	204	CTS25UN	12	CTS95/120N	14	CX2.5/4/4B	125
CSTSRN6R	204	CTS25UNBK	12	CTS95/120NBK	14	CX2.5/4BK	99
CSTSRN6Y	204	CTS25UNBU	12	CTS95/120NBU	14	CX2.5/4BU	99
CTC4U	66	CTS25UNGN	12	CTS95/120NGN	14	CX2.5/4GN	99
CTL2.5U	21	CTS25UNR	12	CTS95/120NR	14	CX2.5/4O	99
CTL2.5U(I.S)	22	CTS25UNY	12	CTS95/120NY	14	CX2.5/4P	99
CTL2.5UBU	21	CTS35	199	CTS95L	208	CX2.5/4R	99
CTL2.5UH	22	CTS35BK	199	CTS95LS	208	CX2.5/4Y	99
CTL2.5UH(I.S)D2	22	CTS35BU	199	CTSEP01	234	CX2.5BK	95
CTL2.5UHBU	22	CTS35L	207	CTSEP1	234	CX2.5BU	95
CTL2.5UHL	23	CTS35LS	207	CTSEP1SC	234	CX2.5GN	95
CTL2.5UL	23	CTS35R	199	CTSEP2	234	CX2.5O	95
CTLG2.5	24	CTS35UN	12	CTSEP3	234	CX2.5PLN	127
CTLG2.5EMOV-275V	72	CTS35UNA	12	CTSEP4	235	CX2.5PN	127
CTS10	198	CTS35UNABK?	12	CTSPC(100mm)	236	CX2.5PN/10	127
CTS10BK	198	CTS35UNABU	12	CTSPC(130mm)	236	CX2.5PN/11	127
CTS10BU	198	CTS35UNAGN	12	CTSPC(150mm)	236	CX2.5PN/12	127
CTS10R	198	CTS35UNAR	12	CTSPC(200mm)	236	CX2.5PN/13	127
CTS10SC	210	CTS35UNAY	12	CTSPC(240mm)	236	CX2.5PN/14	127
CTS10U	11	CTS35UNBK	12	CTSPC(300mm)	236	CX2.5PN/15	127
CTS10UBK	11	CTS35UNBU	12	CTSPC(330mm)	236	CX2.5PN/2	127
CTS10UBU	11	CTS35UNGN	12	CTSPC(40mm)	236	CX2.5PN/3	127
CTS10UGN	11	CTS35UNR	12	CTSPC(430mm)	236	CX2.5PN/4	127
CTS10UO	11	CTS35UNY	12	CTSPC(460mm)	236	CX2.5PN/5	127
CTS10UR	11	CTS35Y	199	CTSPC(760mm)	236	CX2.5PN/6	127
CTS10USC	60	CTS4SC	209	CTSPC(90mm)	236	CX2.5PN/7	127
CTS10UW	11	CTS4UN	10	CTSPC2-1	189	CX2.5PN/8	127

Cat. No.	Pg. No.	Cat. No.	Pg. No.	Cat. No.	Pg. No.	Cat. No.	Pg. No.
CX2.5PN/9	127	CXDL2.5(E)DD2	112	CXVF2.5A	114	CYDLG2.5	84
CX2.5R	95	CXDL2.5(E)DD3	112	CXVF2.5AL12V	114	CYDLG2.5(I.S)	84
CX2.5SN	127	CXDL2.5(E)DD4	112	CXVF2.5AL240V	114	CYDLG4	86
CX2.5SN/10	127	CXDL2.5(E)LD1	112	CXVF2.5AL24V	114	CYDLG4(I.S)	86
CX2.5SN/11	127	CXDL2.5(E)TS1	112	CXVF2.5AL48V	114	CYDLGF4	88
CX2.5SN/12	127	CXDL2.5(I.S)	108	CXVF2.5AL60V	114	CYDLGF4L110-240V	88
CX2.5SN/13	127	CXDL2.5/2B	125	CXVF2.5B	114	CYDLGF4L6-60V	88
CX2.5SN/14	127	CXDL2.5/2B(I.S)	126	CXVF2.5BL12V	114	CYDLGF4LR	88
CX2.5SN/15	127	CXDL2.5BK	107	CXVF2.5BL240V	114	CYDLGK4	90
CX2.5SN/2	127	CXDL2.5BU	107	CXVF2.5BL24V	114	CYDLGK4BU	90
CX2.5SN/3	127	CXDL2.5GN	107	CXVF2.5BL48V	114	CYDLK4	90
CX2.5SN/4	127	CXDL2.5O	107	CXVF2.5BL60V	114	CYDLK4BU	90
CX2.5SN/5	127	CXDL2.5R	107	CXVF2.5C	114	CYF4	87
CX2.5SN/6	127	CXDL2.5Y	107	CXVF2.5CL12V	114	CYF4BK	87
CX2.5SN/7	127	CXDLG2.5	108	CXVF2.5CL240V	114	CYF4BU	87
CX2.5SN/8	127	CXDLG2.5/2B	125	CXVF2.5CL24V	114	CYF4L110-240V	87
CX2.5SN/9	127	CXDLG2.5/2B(I.S)	126	CXVF2.5CL48V	114	CYF4L6-60V	87
CX2.5Y	95	CXF4	113	CXVF2.5CL60V	114	CYG10	80
CX4	96	CXF4/3	114	CXVFA	114	CYG2.5	79
CX4/3	100	CXF4/3L110-240V	114	CXVFB	114	CYG4	80
CX4/3BK	100	CXF4/3L6-60V	114	CXVFB	114	CYG4/3	82
CX4/3BU	100	CXF4L110-240V	113	CXVFB	114	CYG4/4	82
CX4/3GN	100	CXF4L6-60V	113	CXVFB	114	CYG6	80
CX4/3O	100	CXG10	104	CXVFB	114	CYK4	89
CX4/3R	100	CXG10/3	106	CXVFB	114	CYK4BU	89
CX4/3Y	100	CXG2.5	102	CXVFB	114	DB16	53
CX4/4	100	CXG2.5/1B	123	CXVFB	114	DB16BK	53
CX4/4BK	100	CXG2.5/2B	124	CXVFB	114	DB16BU	53
CX4/4BU	100	CXG2.5/3	104	CXVFB	114	DB16GN	53
CX4/4GN	100	CXG2.5/3/1B	124	CXVFB	114	DB16R	53
CX4/4O	100	CXG2.5/4	105	CXVFB	114	DB16Y	53
CX4/4R	100	CXG2.5/4/2B	124	CXVFB	114	DB185	55
CX4/4Y	100	CXG2.5/4/4B	125	CXVFB	114	DB25	54
CX4BK	96	CXG4	103	CXVFB	114	DB25BU	54
CX4BU	96	CXG4/3	105	CXVFB	114	DB25GN	54
CX4GN	96	CXG4/4	106	CXVFB	114	DB35	54
CX4O	96	CXG6	103	CY10	78	DB35BK	54
CX4R	96	CXG6/3	106	CY10BU	78	DB35BU	54
CX4Y	96	CXK2.5	115	CY2.5	77	DB35GN	54
CX6	96	CXK2.5/4	116	CY2.5BU	77	DB35R	54
CX6/3	100	CXK2.5/4BU	116	CY4	78	DB35Y	54
CX6/3BK	100	CXK2.5BU	115	CY4/3	81	DB70	54
CX6/3BU	100	CXK4	116	CY4/3BU	81	DDDL4U	48
CX6/3GN	100	CXK4/3	116	CY4/4	82	DDDL4UBK	48
CX6/3O	100	CXK4/3BU	116	CY4/4BU	82	DDDL4UBU	48
CX6/3R	100	CXK4BU	116	CY4BU	78	DDFL4UE110-240V	35
CX6/3Y	100	CXLPN	127	CY6	78	DDFL4UE110V	35
CX6BK	96	CXM2.5	117	CY6BU	78	DDFL4UE220V	35
CX6BU	96	CXM2.5BK	117	CYDL2.5	83	DDFL4UE24V	35
CX6GN	96	CXM2.5BU	117	CYDL2.5(I.S)	84	DDFL4UE440V	35
CX6O	96	CXM2.5GN	117	CYDL2.5BU	83	DDFL4UE48V	35
CX6R	96	CXM2.5R	117	CYDL4	85	DDFL4UE6-60V	35
CX6Y	96	CXM2.5Y	117	CYDL4(I.S)	86	DDFL4UEL110V	36
CXAF4/3	114	CXMG2.5	118	CYDL4BU	85	DDFL4UEL220V	36
CXAF4/3L110-240V	114	CXPOLN	125	CYDLF4	88	DDFL4UEL24V	36
CXAF4/3L6-60V	114	CXS2.5	119	CYDLF4FT	88	DDFL4UEL440V	36
CXCC4	122	CXS2.5BK	119	CYDLF4FT	88	DDFL4UEL48V	36
CXCP2.5/4	140	CXS2.5BU	119	CYDLF4FT	88	DDFL4ULRW/F	36
CXDB35/10	121	CXS2.5GN	119	CYDLF4L110-240V	88	DDFL4UW/F	35
CXDB35/10A	121	CXS2.5R	119	CYDLF4L6-60V	88	EP1ODL2.5	234
CXDIN	127	CXS2.5Y	119	CYDLF4LR	88	EP1ODL4U	234
CXDL2.5	107	CXS4	120	CYDLF4LRL110-240V	88	EP2.5/4UN	234
CXDL2.5(E)D1	111	CXSG2.5	120	CYDLF4LRL6-60V	88	EP4P	235
CXDL2.5(E)D2	111	CXSG4	120	CYDLFG4FT	88	EP6/10U	234
CXDL2.5(E)D3	111	CXSR2N	127	CYDLFG4FT	88	EPADLG2.5	234
CXDL2.5(E)DD1	112	CXSR4N	127	CYDLFG4FT	88	EPAS2.5	234

Cat. No.	Pg. No.	Cat. No.	Pg. No.	Cat. No.	Pg. No.	Cat. No.	Pg. No.
EPAS4	234	GMH3	219	PL-34902057	226	SCS0.6/3.5	237
EPAS6	234	GMH4	219	PL-34902081	226	SCS0.6/3.5I	237
EPATL2.5	234	GMH5	219	PL-35003118	226	SCS0.8/4	237
EPATL2.5H	234	GMH6	219	PL-35003125	226	SCS0.8/4I	237
EPATLG2.5	234	GMH7	219	PL-35003135	226	SCS1/5.5	237
EPCAFL4U	234	GMH8	219	PL-35003150	226	SCS1/5.5I	237
EPCBS3U	234	GMH8N	219	PL-35003170	226	SP2.5/4UN	235
EPCDGL2.5	234	JX1.5/10	233	PL-35003200	226	SP6/10U	235
EPCDL4UN	234	JX1.5/2	233	PL-35010000	226	SPCDL4U	235
EPCDS6U	234	JX1.5/3	233	PL-35010001	226	SPCDLG2.5	235
EPCDTTU	234	JX1.5/4	233	PL-35010002	226	SPCMB4	235
EPCGT4U	234	JX10/2	233	PL-35010003	226	SPCP8L32	235
EPCKT4U	234	JX2.5/10	233	PL-35010004	226	STH3	173
EPCKT4U/4	234	JX2.5/2	233	PL-35010005	226	STH4	174
EPCM1.5S	234	JX2.5/3	233	PL-35010006	226	STH4DT	183
EPCM2.5S	234	JX2.5/4	233	PL-35010030	226	STH4DT/S	183
EPCM4S	234	JX2.5/5	233	PL-35010031	226	STH4DTFFT	184
EPCMB4	234	JX2.5/6	233	PL-35010032	226	STH4DTSH	184
EPCMC1-2	234	JX2.5/7	233	PL-35010033	226	STH4DTTP	183
EPCMC2-2	234	JX2.5/8	233	PL-35010034	226	STH4TP	174
EPCMDT4	234	JX4/10	233	PL-35010035	226	STH6	174
EPCMS2.5	234	JX4/2	233	PL-35010036	226	SWCDS	44
EPCMT4	234	JX4/3	233	PL-35010037	226	SWL16	223
EPCP1.5	235	JX4/4	233	PL-35010038	226	SWL4	223
EPCP1.5/3	235	JX4/8	233	PL-35010039	226	SWL6	223
EPCP1.5/4	235	JX6/10	233	PP2.5/4UN	235	TM3.5	219
EPCP3L2.5	235	JX6/2	233	PP25UN	235	TM5	219
EPCP4LG2.5	235	JX6/3	233	PP35UN	235	TPSL5	44
EPCPDL1.5	235	JX6/4	233	PP6/10U	235	TPSL5BK	44
EPCPDLK2.5	235	JXS10/2.5	233	PPCBB	235	TPSL5BU	44
EPCPPT2.5/3	235	JXS10/6	233	PPCBB1	235	TPSLSR	44
EPCSC16T	234	JXS4/2.5	233	PPCMT4	235	TPSLSY	44
EPCSCP2.5T(L&R)	234	JXS6/2.5	233	PPCSFL4U	235	TX2.5	223
EPCSTSU	234	JXS6/4	233	PPCX10	235	WLX10	223
EPCTC4U	234	JY10/2	233	PPCX4	235	WLX2.5	223
EPCTL2.5U	234	JY6/10	233	PPCX4/3	235	WLX2.5/V	223
EPCTL2.5UH	234	JY6/2	233	PPCX4/4	235	WLX4	223
EPCTLG2.5	234	JY6/3	233	PPCY2.5/10	235	WLX6	223
EPCX10	234	JY6/4	233	PPCYDL2.5/4	235		
EPCX10/3	234	LCCDS	44	PTB35/50	192		
EPCX2.5	234	MH2.5	221	PTB35/50SH	192		
EPCX2.5/3	234	MH4	221	PTB70/95	193		
EPCX2.5/4	234	MS3.5WHT	222	PTB70/95SH	193		
EPCX2.5SN	234	MS5WHT	222	RBCP8L32	235		
EPCX4	234	NEB10	29	SCA2.5	221		
EPCX4/3	234	NEB6	29	SCM0.4/2.5	238		
EPCX4/4	234	NES	29	SCM0.5/3	238		
EPCX6	234	NESCC	31	SCM0.8/4	238		
EPCX6/3	234	ODL2.5	17	SCM1/5.5	238		
EPCXCP2.5	235	ODL2.5(I.S)	18	SCNT4	238		
EPCXDL2.5	234	ODL2.5A	17	SCNT5	238		
EPCXM2.5	235	ODL2.5A(I.S)	18	SCNT6	238		
EPCXS2.5	234	ODL4U	20	SCPH1	238		
EPCY2.5/10	235	ODL4UA	20	SCPH2	238		
EPCYDL2.5/4	235	ODL4UBU	20	SCPH2I	238		
EPDDFL4U	234	ODLG2.5	18	SCS0.5/3	237		
EPODL2.5	234	ODLG2.5(I.S)	18	SCS0.5/3I	237		
EPODL4U	234	ODLG2.5A	18				
EPSTH3	234	ODLG2.5A(I.S)	18				
EPSTH4	234	PDB400	55				
EPSTH4DT	234	PL-34000083	225				
EPSTH6	234	PL-34130010	226				
EPUSC	234	PL-34130015	226				
FPCMST	211	PL-34130098	225				
GMH1	219	PL-34130099	225				
GMH2	219	PL-34902001	226				

Note: The product information is carefully compiled and is accurate for most of the application. New findings in materials and process technology necessitate modification of the products. We reserve the right to change / modify the product without intimation. However the changes that take place without notice in no way reduce function or performance of the product.

MKT/8.2/01 JUNE 2019 x 3000



CONNECTWELL INDUSTRIES PVT. LTD.

D-7, Phase 2, M.I.D.C., Dombivli - 421 204, India

Tel.: + 91 251 7120 600 / 6762 600

Fax : + 91 251 7120 700

connect@connectwell.com | www.connectwell.com